



Your knowledgeable and trusted partner
for the best in water management solutions.

Product Catalog



Residential & Commercial Drainage | Professional Irrigation | Valve and Meter Boxes | Flow Management

MADE IN
USA

2026-2027 | ndspro.com



Since 1972, NDS has been producing plastic drainage and landscape products. From the beginning, our commitment to leading the industry has been unwavering, leading to remarkable innovations and state-of-the-art products that fit every environment, every schedule, every need.

Today, our commitment to providing one-source solutions has led to the development of superior quality drainage products, landscape products, fittings, valve and meter boxes, and drip and micro irrigation products. No product is added to our line without meeting exhaustive testing and extensive research requirements. Plus, we are uniquely able to offer our complete inventory of products to the US and Puerto Rico from regional warehouses across the US. Our goal: one-business-day delivery. Our track record: outstanding.

Take a moment to look through this catalog, noting the depth of our product offering. If you have any questions or to place an order, just call 1-800-726-1994 from 5 a.m. to 5 p.m. PST and let us offer the best solution to you.

Brand Promise



NDS[®] is your knowledgeable and trusted partner for the best in water management solutions.

We care about your success and provide industry-leading products, expert guidance, and dedicated support you won't find anywhere else.



Access Boxes

NDS valve and meter boxes are proudly manufactured in Lindsay, CA and Lithia Springs, GA and span a wide variety of sizes, from 6 in. round to 17 in. x 30 in. rectangular, with multiple color options and designations. Our meter boxes are designed specifically for the Automatic Meter Reading industry. All our boxes are injection molded and contain UV inhibitors for durability, preventing discoloration, cracking, and ensuring long-lasting performance in direct sunlight.



Product Applications



Irrigation

NDS Pro-Spec® and Standard Series valve boxes protect irrigation system components from the elements, foot traffic, lawncare equipment, and potential vandalism, and keep them out of sight.



Water Metering

Meter boxes protect water meter components from the elements, foot traffic, lawncare equipment, and potential vandalism, and keep them out of sight.



Telecom

Pro-Spec® commercial grade telecom boxes are engineered for heavy-duty use and designed for ease of installation and service for most types of FTTH (fiber to the home) applications. Available with optional marker disc.

We put water in its place™

Valve Boxes

Standard Series

Designed for residential and light commercial applications. Injection-molded of structural foam polyolefin.

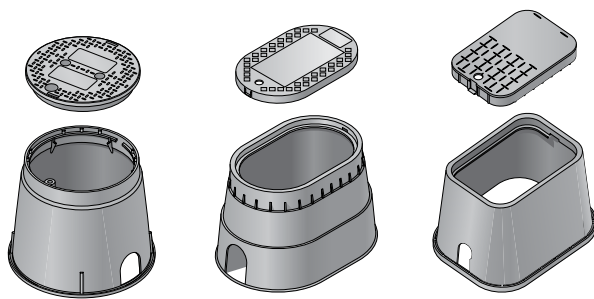

Round

Oval

Rectangle

NDS Pro-Spec® Series - Commercial Grade

Designed for commercial applications. Injection-molded of high-impact, high-density structural foam polyethylene. Custom lid inserts available for large opportunities.

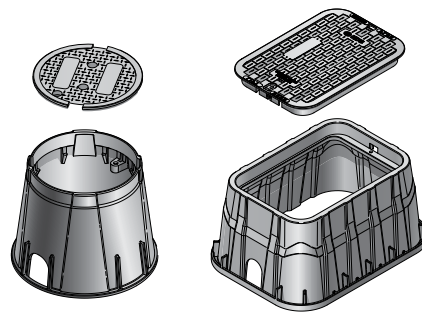

Round

Rectangle

Meter Boxes

Superior signal transmission versus products made of concrete materials or cast iron. Lighter weight material eases installation and lowers freight and handling costs.

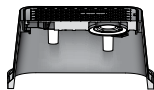

AMR Bottom Mounts

Concealed, protected antennae with exceptional signal, minimal interference, and compatibility with most industry models.

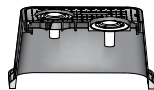

AMR Top Mounts

Recessed design reduces damage risk, eliminates interference, and accommodates most industry antennae, including Touch Read.

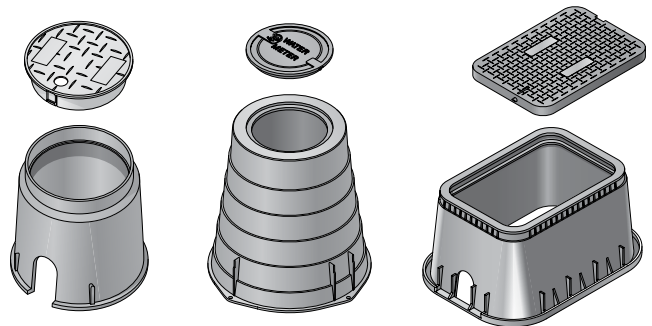

Round

Oval

Rectangle

Pro-Spec® Telecom Boxes

Also available in Round and Rectangle

NDS Pro-Spec® Series Valve Boxes – next generation commercial grade

NDS Pro-Spec® 10 in. Round Corrugated Valve Boxes

Specifications: The NDS Pro-Spec® 10 in. round body is tapered and has a minimum wall thickness of 0.250 in. The cover seat area has 8 structural support ribs on the underside of the seat, each with a minimum thickness of 0.250 in. The bottom of the body has a 0.500 in. flange. The 10 in. round cover has the patented Universal Locking Mechanism (ULM) that enables various sizes of bolts/screws to secure cover ranging in sizes from 3/8 to 1/2 in. diameter and minimum 2-1/2 in. length. Nut is no longer needed. A speed or clip nut slot also exists (clip nut not supplied).

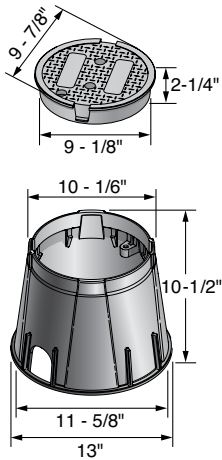

Part No.	Description	Color (Box/Cover)	Pallet Qty.	Weight Ea. (lbs.)	Product Class
Box & Cover					
311BC	10" Round Box, Round Overlapping Cover - ICV	Black/Green	132	4.6	20PR
311BCB	10" Round Box, Round Overlapping Bolt-Down Cover - ICV	Black/Green	132	4.6	20PR
311BCBLK	10" Round Box, Round Overlapping Cover - ICV	Black/Black	132	4.6	20PR
311BCR	10" Round Box, Round Overlapping Cover - Reclaimed Water	Black/Purple	132	4.6	20PR
311BCS	10" Round Box, Round Overlapping Cover - Sewer	Black/Green	132	4.6	20PR
312BC	10" Round Box, Round Overlapping Cover - ICV	Green/Green	132	4.6	20PR
312BC ELEC	10" Round Box, Round Overlapping Cover - Electric	Gray/Gray	132	4.6	20PR
312BCB	10" Round Box, Round Overlapping Bolt-Down Cover - ICV	Green/Green	132	4.4	20PR
312BCB ELEC	10" Round Box, Round Overlapping Bolt-Down Cover - Electric	Gray/Gray	132	4.6	20PR
312BCBS	10" Round Box, Round Overlapping Bolt-Down Cover - Sewer	Green/Green	132	4.6	20PR
312BCRBLK	10" Round Overlapping Reclaimed Cover	Black/Black	132	4.7	20PR
312BCRG	10" Round Box, Round Overlapping Cover - Reclaimed Water	Green/Green	132	4.6	20PR
312BCS	10" Round Box, Round Overlapping Cover - Sewer	Green/Green	132	4.6	20PR
312BCSAND	10" Round Box, Round Overlapping Cover - ICV	Sand/Sand	132	4.4	20PR
312BCW	10" Round Box, Round Overlapping Cover - Water	Green/Green	132	4.6	20PR
312PBCBR	10" Round Box, Round Overlapping Bolt-Down Cover - Reclaimed Water	Purple/Purple	132	4.4	20PR
312PBCR	10" Round Box, Round Overlapping Cover - Reclaimed Water	Purple/Purple	132	4.4	20PR
Cover Only					
311C	10" Round Overlapping Cover - ICV	Green	200	1.5	20PR
311C BLK	10" Round Overlapping Cover - ICV	Black	200	1.5	20PR
311C ELEC	10" Round Overlapping Cover - Electric	Gray	200	1.5	20PR
311CR	10" Round Overlapping Cover - Reclaimed Water	Purple	200	1.4	20PR
311CRG	10" Round Overlapping Cover - Reclaimed Water	Green	200	1.5	20PR
311CS	10" Round Overlapping Cover - Sewer	Green	200	1.5	20PR
311CSAND	10" Round Overlapping Cover - ICV	Sand	200	1.4	20PR
311CW	10" Round Overlapping Cover - Water	Green	200	1.5	20PR
Box Only					
311B	10" Round Box	Black	132	3	20PR
312B	10" Round Box	Green	132	3	20PR
312PB	10" Round Box	Purple	132	3	20PR
113BB	3/8" x 2-3/4" SS Bolt	Steel	n/a	0.1	20NM

NDS Pro-Spec® 14 in. x 19 in. Rectangular Valve Boxes

Specifications: The NDS Pro-Spec® 14 in. x 19 in. body is tapered and has a minimum wall thickness of 0.187 in. The body has a double wall at the top cover seat area with a minimum thickness of 0.200 in. The cover seat area has 18 structural support ribs on the underside of the seat, each with a minimum thickness of 0.200 in. The bottom of the body has a 0.500 in. flange. The 14 in. x 19 in. cover has an average thickness of 0.200 in. The valve box has the patented Universal Locking Mechanism (ULM) that enables various sizes of bolts/screws to secure cover ranging in sizes from 3/8 to 1/2 in. diameter and minimum 2-1/2 in. length. Nut is no longer needed. A speed or clip nut slot also exists (clip nut not supplied).

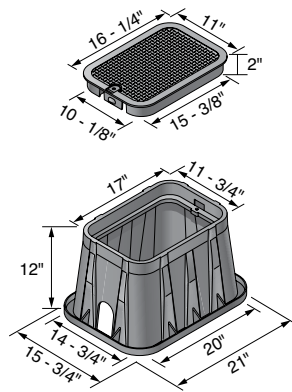

Part No.	Description	Color (Box/Cover)	Pallet Qty.	Weight Ea. (lbs.)	Product Class
Box & Cover					
313BC	14" x 19" Box, Overlapping Cover - ICV	Black/Green	72	8.4	20PR
313BCB	14" x 19" Box, Overlapping Bolt-Down Cover - ICV	Black/Green	72	8.5	20PR
313BCBBLK	14" x 19" Box, Overlapping Bolt-Down Cover - ICV	Black/Black	72	8.5	20PR
313BCBR	14" x 19" Box, Overlapping Bolt-Down Cover - Reclaimed Water	Black/Purple	72	8.5	20PR
313BCBRBLK	14" x 19" Box, Overlapping Bolt-Down Cover - Reclaimed Water	Black/Black	72	8.5	20PR
313BCBWBLK	14" x 19" Box, Overlapping Bolt-Down Cover - Water	Black/Black	72	8.5	20PR
314BC	14" x 19" Box, Overlapping Cover - ICV	Green/Green	72	8.5	20PR
314BCB	14" x 19" Box, Overlapping Bolt-Down Cover - ICV	Green/Green	72	8.5	20PR
314BCB ELEC	14" x 19" Box, Overlapping Bolt-Down Cover - Electric	Gray/Gray	72	8.5	20PR
314BCBRG	14" x 19" Box, Overlapping Bolt-Down Cover - Reclaimed Water	Green/Green	72	8.5	20PR
314BCBS	14" x 19" Box, Overlapping Bolt-Down Cover - Sewer	Green/Green	72	8.5	20PR
314BCBSAND	14" x 19" Box, Overlapping Bolt-Down Cover - ICV	Sand/Sand	72	8.5	20PR
314BCBW	14" x 19" Box, Overlapping Bolt-Down Cover - Water	Green/Green	72	8.5	20PR
314BCSAND	14" x 19" Box, Overlapping Cover - ICV	Sand/Sand	72	8.2	20PR
314PBCBR	14" x 19" Box, Overlapping Bolt-Down Cover - Reclaimed Water	Purple/Purple	72	8.4	20PR
314PBCR	14" x 19" Box, Overlapping Cover - Reclaimed Water	Purple/Purple	72	7.3	20PR
Cover Only					
313C	14" x 19" Overlapping Cover - ICV	Green	300	2.3	20PR
313C ELEC	14" x 19" Overlapping Cover - Electric	Gray	300	2.3	20PR
313CBLK	14" x 19" Overlapping Cover - ICV	Black	300	2.3	20PR
313CG ELEC	14" x 19" Overlapping Cover - Electric	Green	300	2.3	20PR
313CR	14" x 19" Overlapping Cover - Reclaimed Water	Purple	300	2.3	20PR
313CRBLK	14" x 19" Overlapping Cover - Reclaimed Water	Black	300	2.81	20PR
313CRG	14" x 19" Overlapping Cover - Reclaimed Water	Green	300	2.3	20PR
313CSAND	14" x 19" Overlapping Cover - ICV	Sand	300	2.3	20PR
313CW	14" x 19" Overlapping Cover - Water	Black	300	2.3	20PR
314CS	14" x 19" Overlapping Cover - Sewer	Green	300	2.3	20PR
314CW	14" x 19" Overlapping Cover - Water	Green	300	2.3	20PR
Box Only					
314B	14" x 19" Box	Green	72	5	20PR
314BBLK	14" x 19" Valve Box	Black	72	5.41	20PR
113BB	3/8" x 2-3/4" SS Bolt	Steel	n/a	0.1	20NM

NDS Pro-Spec® 13 in. x 20 in. Rectangular Valve Boxes

Specifications: The NDS Pro-Spec® 13 in. x 20 in. body is tapered and has a minimum wall thickness of 0.250 in. The body has a double wall at the top cover seat area with a minimum thickness of 0.250 in. The cover seat area has 22 structural support ribs on the underside of the seat, each with a minimum thickness of 0.13 in. The bottom of the body has a 0.500 in. flange. The 13 in. x 20 in. cover has an average thickness of 0.250 in. The valve box has a 3/8 in. brass nut for the bolt-down as a standard feature.

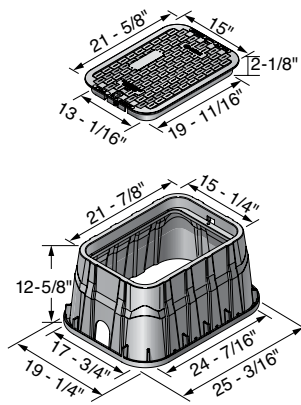

Part No.	Description	Color (Box/Cover)	Pallet Qty.	Weight Ea. (lbs.)	Product Class
Box & Cover					
317BCB	13" x 20" Jumbo Box, Overlapping Bolt-Down Cover - ICV	Black/Green	56	14.6	20PR
317BCBBLK	13" x 20" Jumbo Box, Overlapping Bolt-Down Cover - ICV	Black/Black	56	14.6	20PR
317BCBW	13" x 20" Jumbo Box, Overlapping Bolt-Down Cover - Water	Black/Black	56	14.6	20PR
318BC	13" x 20" Jumbo Box, Overlapping Cover - ICV	Green/Green	56	14.6	20PR
318BCB	13" x 20" Jumbo Box, Overlapping Bolt-Down Cover - ICV	Green/Green	56	14.6	20PR
318BCBRBLK	13" x 20" Jumbo Box, Overlapping Bolt-Down Cover - Reclaimed Water	Black/Black	56	14.6	20PR
318BCBRG	13" x 20" Jumbo Box, Overlapping Bolt-Down Cover - Reclaimed Water	Green/Green	56	14.6	20PR
318BCBS	13" x 20" Jumbo Box, Overlapping Bolt-Down Cover - Sewer	Green/Green	56	14.6	20PR
318BCBSAND	13" x 20" Jumbo Box, Overlapping Bolt-Down Cover - ICV	Sand/Sand	56	14.6	20PR
318PBCBR	13" x 20" Jumbo Box, Overlapping Bolt-Down Cover - Reclaimed Water	Purple/Purple	56	10.7	20PR
318PBCR	13" x 20" Jumbo Box, Overlapping Cover - Reclaimed Water	Purple/Purple	56	14.6	20PR
Cover Only					
317C	13" x 20" Overlapping Cover - ICV	Green	180	5.1	20PR
317C BLK	13" x 20" Overlapping Cover - ICV	Black	180	5.1	20PR
317CR	13" x 20" Overlapping Cover - Reclaimed Water	Purple	180	5	20PR
317CS	13" x 20" Overlapping Cover - Sewer	Green	180	5.1	20PR
317CSAND	13" x 20" Overlapping Cover - ICV	Sand	180	5	20PR
317CW	13" x 20" Overlapping Cover - Water	Black	180	5.1	20PR
318CW	13" x 20" Overlapping Cover - Water	Green	180	5.1	20PR
Box Only					
318B	13" x 20" Jumbo Box	Green	56	9.2	20PR
318B BLK	13" x 20" Jumbo Box	Black	56	9.2	20PR
318PB	13" x 20" Jumbo Box	Purple	56	9.55	20PR
113BB	3/8" x 2-3/4" SS Bolt	Steel	n/a	0.1	20NM

We put water in its place™

NDS Pro-Spec® 13 in. x 24 in. Rectangular Valve Boxes

Specifications: The NDS Pro-Spec® 13 in. x 24 in. body is tapered and has a minimum wall thickness of 0.270 in. The body has a double wall at the top cover seat area with a minimum thickness of 0.270 in. The cover seat area has 18 structural support ribs on the underside of the seat, each with a minimum thickness of 0.250 in. The bottom of the body has a 1.0 in. flange. The 13 in. x 24 in. cover has an average thickness of 0.320 in. The valve box has a 3/8 in. brass nut for the bolt-down as a standard feature.

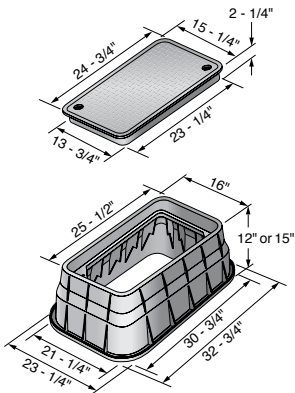

Part No.	Description	Color (Box/Cover)	Pallet Qty.	Weight Ea. (lbs.)	Product Class
Box & Cover					
321BCB	13" x 24" x 12" Box, Overlapping Bolt-Down Cover - ICV	Green/Green	12	24	20PR
321BCBS	13" x 24" x 12" Box, Overlapping Bolt-Down Cover - Sewer	Green/Green	12	24	20PR
321BCBW	13" x 24" x 12" Box, Overlapping Bolt-Down Cover - Water	Green/Green	12	24	20PR
322BCB	13" x 24" x 15" Box, Overlapping Bolt-Down Cover - ICV	Green/Green	12	24	20PR
322PBCBR	13" x 24" x 12" Box, Overlapping Bolt-Down Cover - Reclaimed Water	Purple/Purple	12	24	20PR
325BCB	13" x 24" x 15" Box, Overlapping Bolt-Down Cover - ICV	Black/Green	12	24	20PR
Cover Only					
322C	13" x 24" Overlapping Cover - ICV	Green	125	7	20PR
322CS	13" x 24" Overlapping Cover - Sewer	Green	125	7	20PR
Box Only					
321B	13" x 24" x 12" Box	Green	12	19	20PR
322B	13" x 24" x 15" Box	Green	12	19	20PR
325B	13" x 24" x 15" Box	Black	12	19	20PR
121BB	3/8" x 3" SS Bolt	Steel	n/a	0.1	20NM

NDS Pro-Spec® 17 in. x 30 in. Rectangular Valve Boxes

Specifications: The NDS Pro-Spec® 17 in. x 30 in. body is tapered and has a minimum wall thickness of 0.320 in. The body has a double wall at the top cover seat area with a minimum thickness of 0.320 in. The cover seat area has 20 structural support ribs on the underside of the seat, each with a minimum thickness of 0.250 in. The bottom of the body has a 1.000 in. flange. The 17 in. x 30 in. cover has an average thickness of 0.350 in. The valve box has a 3/8 in. brass nut for the bolt-down as a standard feature.

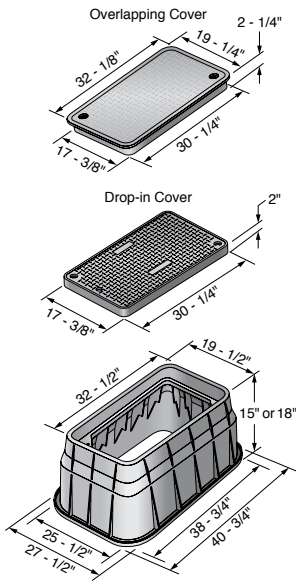

Part No.	Description	Color (Box/Cover)	Pallet Qty.	Weight Ea. (lbs.)	Product Class
Box & Cover					
324BCB	17" x 30" x 15" Box, Overlapping Bolt-Down Cover - ICV	Green/Green	6	28	20PR
324BCB-BG	17" x 30" x 15" Box, Overlapping Bolt-Down Cover - ICV	Black/Green	6	28	20PR
324BCBS	17" x 30" x 15" Box, Overlapping Bolt-Down Cover - Sewer	Green/Green	6	28	20PR
324BCDB	17" x 30" x 15" Box, Drop-in Bolt-Down Cover - ICV	Green/Green	6	28	20PR
326BCB	17" x 30" x 18" Box, Overlapping Bolt-Down Cover - ICV	Green/Green	6	39	20PR
326BCB-BG	17" x 30" x 18" Box, Overlapping Bolt-Down Cover - ICV	Black/Green	6	41	20PR
326BCDB	17" x 30" x 18" Box, Drop-in Bolt-Down Cover - ICV	Green/Green	6	37	20PR
326BCDB ELEC	17" x 30" x 18" Box, Drop-in Cover - Electric	Gray/Gray	6	37	20PR
326BCDB-BG	17" x 30" x 18" Box, Drop-in Bolt-Down Cover - ICV	Black/Green	6	37	20ND
326BCDBW	17" x 30" x 18" Box, Drop-in Bolt-Down Cover - Water	Black/Black	6	37	20ND
326PBCBR	17" x 30" x 18" Box, Overlapping Cover - Reclaimed Water	Purple/Purple	6	38	20PR
Cover Only					
323C	17" x 30" Overlapping Cover - ICV	Green	75	11	20PR
323CD	17" x 30" Drop-in Cover - ICV	Green	75	11	20PR
323CD ELEC	17" x 30" Drop-in Cover - Electric	Gray	75	11	20PR
323CDW	17" x 30" Drop-in Cover - Water	Black	75	11	20PR
323CR	17" x 30" Overlapping Cover - Reclaimed Water	Purple	75	11	20PR
323CS	17" x 30" Overlapping Cover - Sewer	Green	75	11	20PR
Box Only					
324B	17" x 30" x 15" Box	Green	6	20	20PR
324B BLK	17" x 30" x 15" Box	Black	6	20	20PR
326B	17" x 30" x 18" Box	Green	10	23	20PR
326B BLK	17" x 30" x 18" Box	Black	10	23	20PR

Standard Series Valve Boxes

Standard Series 6 in. Round Valve Boxes

Specifications: The NDS Standard Series 6 in. round body is tapered and has a minimum wall thickness of 0.200 in. The body has a double wall at the top cover seat area with a minimum thickness of 0.130 in. The bottom of the body has a 0.250 in. flange. The 6 in. round cover has an average thickness of 0.187 in.

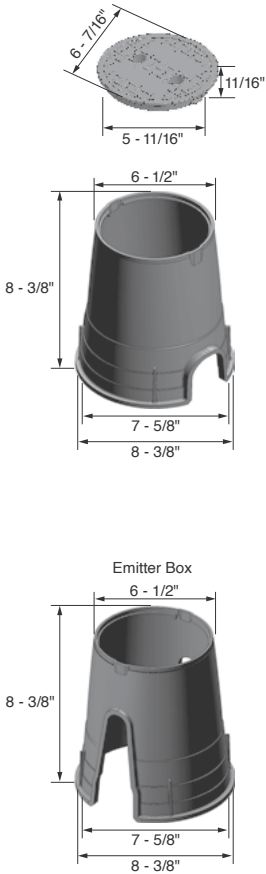

Part No.	Description	Color (Box/Cover)	Pallet Qty.	Weight Ea. (lbs.)	Product Class
Box & Cover					
107BC	6" Round Box, Round Overlapping Cover - ICV	Black/Green	250	1.5	20ND
107BC BLK	6" Round Box, Round Overlapping Cover - ICV	Black/Black	250	1.5	20ND
107BC SAND	6" Round Box, Round Overlapping Cover - ICV	Sand/Sand	250	1.5	20ND
107BC SLV	6" Round Box, Round Overlapping Cover - ICV - 20 per sleeve	Black/Green	400	1.5	20ND
107BCH	6" Round Snap-in Valve Box, Round Snap-in Overlapping Cover - ICV	Black/Green	250	1.5	20ND
107BCR	6" Round Box, Round Overlapping Cover - Reclaimed Water	Black/Purple	250	1.5	20ND
107BCR BLK	6" Round Box, Round Overlapping Cover - Reclaimed Water	Black/Black	250	1.5	20ND
107BCS	6" Round Box, Round Overlapping Cover - Sewer	Black/Green	250	1.5	20NM
107BCW	6" Round Box, Round Overlapping Solid Plastic Cover - Water	Black/Green	250	1.5	20NM
107EBC	6" Round Emitter Box, Round Overlapping Cover - Emitter Box	Black/Green	250	1.5	20ND
107PBCR	6" Round Box, Round Overlapping Cover - Reclaimed Water	Purple/Purple	250	1.5	20ND
108BC	6" Round Box, Round Overlapping Cover - ICV	Green/Green	250	1.5	20ND
108BCS	6" Round Box, Round Overlapping Cover - Sewer	Green/Green	250	1.5	20ND
108BCW	6" Round Box, Round Overlapping Cover - Water	Green/Green	250	1.5	20ND
Cover Only					
107C	6" Round Overlapping Cover - ICV	Green	800	0.36	20ND
107C BLK	6" Round Cover ICV	Black	250	1.5	20ND
107C BRN	6" Round Cover ICV	Brown	250	1.5	20ND
107C SAND	6" Round Overlapping Cover - ICV	Sand	800	0.4	20ND
107CH	6" Round Snap-in Overlapping Cover - ICV	Green	1200	0.35	20ND
107CR	6" Round Overlapping Cover - Reclaimed Water	Purple	800	0.4	20ND
107CS	6" Round Overlapping Cover - Sewer	Green	800	0.4	20NM
107CW	6" Round Overlapping Cover - Water	Green	800	0.4	20NM
Box Only					
106B	6" Round Snap-in Valve Box	Black	250	0.9	20ND
107B	6" Round Box	Black	250	1.23	20ND
108B	6" Round Box	Green	250	1.23	20ND

Standard Series 10 in. Round Valve Boxes

Specifications: The NDS Standard Series 10 in. round body is tapered and has a minimum wall thickness of 0.200 in. The cover seat area has 6 structural support ribs on the underside of the seat, each with a minimum thickness of 0.250 in. The bottom of the body has a 0.500 in. flange. The 10 in. round cover has an average thickness of 0.250 in. The valve box has the patented Universal Locking Mechanism (ULM) that enables various sizes of bolts/screws to secure cover ranging in sizes from 5/16 in. to 3/8 in. diameter and minimum 1-1/2 in. length. Nut is no longer needed. A speed or clip nut slot also exists (clip nut not supplied).

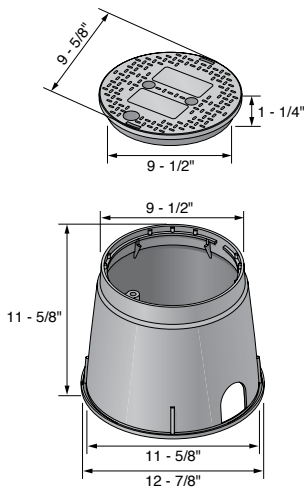

Part No.	Description	Color (Box/Cover)	Pallet Qty.	Weight Ea. (lbs.)	Product Class
Box & Cover					
111BC	10" Round Box, Round Overlapping Cover - ICV	Black/Green	180	3	20ND
111BC BLK	10" Round Box, Round Overlapping Cover - ICV	Black/Black	180	3	20ND
111BC CTN	10" Round Box, Round Overlapping Cover - ICV - 4 per carton	Black/Green	72	3.9	20ND
111BC SAND	10" Round Box, Round Overlapping Cover - ICV	Sand/Sand	180	3.2	20ND
111BCB	10" Round Box, Round Overlapping Bolt-Down Cover - ICV	Black/Green	180	3	20ND
111BCBW	10" Round Box, Round Overlapping Bolt-Down Cover - Water	Black/Black	180	3	20NM
111BCR	10" Round Box, Round Overlapping Cover - Reclaimed Water	Black/Purple	180	3	20ND
111BCR BLK	10" Round Box, Round Overlapping Cover - Reclaimed Water	Black/Black	180	3	20ND
111BCS	10" Round Box, Round Overlapping Cover - Sewer	Black/Green	180	3	20NM
111BCW	10" Round Box, Round Overlapping Cover - Water	Black/Green	180	3	20NM
111PBCR	10" Round Box, Round Overlapping Cover - Reclaimed Water	Purple/Purple	180	3	20ND
112BC	10" Round Box, Round Overlapping Cover - ICV	Green/Green	180	3	20ND
112BCB	10" Round Box, Round Overlapping Bolt-Down Cover - ICV	Green/Green	180	3	20ND
112BCRG	10" Round Box, Round Overlapping Cover - Reclaimed Water	Green/Green	180	3	20ND
112BCS	10" Round Box, Round Overlapping Cover - Sewer	Green/Green	180	3.9	20NM
Cover Only					
111C	10" Round Overlapping Cover - ICV	Green	300	0.95	20ND
111C BLK	10" Round Overlapping Cover - ICV	Black	300	0.95	20ND
111C BRN	10" Round Overlapping Cover - ICV	Brown	300	0.95	20ND
111C SAND	10" Round Overlapping Cover - ICV	Sand	300	0.95	20ND
111CR	10" Round Overlapping Cover - Reclaimed Water	Purple	300	1	20ND
111CS	10" Round Overlapping Cover - Sewer	Green	300	1	20NM
111CW BLK	10" Round Overlapping Cover - Water	Black	300	0.95	20ND
111CW	10" Round Overlapping Cover - Water	Green	300	1	20NM
Box Only					
111B	10" Round Box	Black	180	2	20ND
112B	10" Round Box	Green	300	2	20ND
111BB	5/16" x 1-3/4" SS Bolt	Steel	n/a	0.05	20ND

Standard Series 14 in. x 19 in. Rectangular Valve Boxes

Specifications: The NDS Standard Series 14 in. x 19 in. body is tapered and has a minimum wall thickness of 0.200 in. The body has a double wall at the top cover seat area with a minimum thickness of 0.250 in. The cover seat area has 16 structural support ribs on the underside of the seat, each with a minimum thickness of 0.250 in. The bottom of the body has a 0.500 in. flange. The 14 in. x 19 in. cover has an average thickness of 0.250 in. The valve box has the patented Universal Locking Mechanism (ULM) that enables various sizes of bolts/screws to secure cover ranging in sizes from 3/8 to 1/2 in. diameter and minimum 2-1/2 in. length. Nut is no longer needed. A speed or clip nut slot also exists (clip nut not supplied). The 6 in. straight wall extensions have a 3/8 in. brass nut for bolt-down as a standard feature.

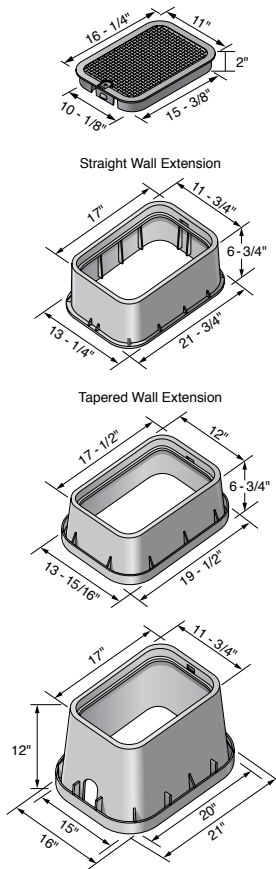

Part No.	Description	Color (Box/Cover)	Pallet Qty.	Weight Ea. (lbs.)	Product Class
Box & Cover					
115	14" x 19" x 6" Straight Wall Extension, Overlapping Cover - ICV	Black/Green	49	16.16	20ND
116	14" x 19" x 6" Straight Wall Extension, Overlapping Cover - ICV	Green/Green	49	6.16	20ND
113BC	14" x 19" Box, Overlapping Cover - ICV	Black/Green	78	9.1	20ND
113BC SAND	14" x 19" Box, Overlapping Cover - ICV	Sand/Sand	78	9.25	20ND
113BCBLK	14" x 19" Box, Overlapping Cover - ICV	Black/Black	78	9.1	20ND
113BCD	14" x 19" Box, Drop-in Cover - ICV	Black/Green	78	8	20ND
113BCE	14" x 19" Box, Overlapping Cover - Electrical	Black/Green	78	9.32	20NM
113BCR	14" x 19" Box, Overlapping Cover - Reclaimed Water	Black/Purple	78	9.1	20ND
113BCRBLK	14" x 19" Box, Overlapping Cover - Reclaimed Water	Black/Black	78	9.1	20NM
113BCS	14" x 19" Box, Overlapping Cover - Sewer	Black/Green	78	9.1	20ND
113BCW	14" x 19" Box, Overlapping Cover - Water	Black/Black	78	9.32	20NM
113BCWG	14" x 19" Box, Overlapping Cover - Water	Black/Green	78	9.1	20ND
113PBCR	14" x 19" Box, Overlapping Cover - Reclaimed Water	Purple/Purple	78	9.29	20ND
114BC	14" x 19" Box, Overlapping Cover - ICV	Green/Green	78	9.95	20ND
114BCS	14" x 19" Box, Overlapping Cover - Sewer	Green/Green	78	9.95	20NM
114BCW	14" x 19" Box, Overlapping Cover - Water	Green/Green	78	9.95	20NM
115BCR	14" x 19" x 6" Box, Overlapping Cover - ICV	Black/Purple	42	7.29	20ND
115TBC	14" x 19" x 6" Tapered Box, Overlapping Cover - ICV	Black/Green	96	6	20ND
115TBCR	14" x 19" x 6" Tapered Box, Overlapping Cover - Reclaimed Water	Black/Purple	96	5.7	20ND
116-SAND	14" x 19" x 6" Straight Wall Extension, Overlapping Cover - ICV	Sand/Sand	49	6	20ND
116TBC	14" x 19" x 6" Tapered Box, Overlapping Cover - ICV	Green/Green	96	5.55	20ND
116TBC SAND	14" x 19" x 6" Tapered Box, Overlapping Cover - ICV	Sand/Sand	96	6.16	20ND
Cover Only					
113C	14" x 19" Overlapping Cover - ICV	Green	300	2	20ND
113C BRN	14" x 19" Overlapping Cover - ICV	Brown	300	2	20ND
113C SAND	14" x 19" Overlapping Cover - ICV	Sand	300	2	20ND
113CB	14" x 19" Overlapping Cover - ICV	Black	300	2	20ND
113CE	14" x 19" Overlapping Cover - Electrical	Green	300	2.3	20NM
113CR	14" x 19" Overlapping Cover - Reclaimed Water	Purple	300	2.5	20ND
113CRG	14" x 19" Overlapping Cover - Reclaimed Water	Green	300	2	20ND
113CS	14" x 19" Overlapping Cover - Sewer	Green	300	2	20NM
113CW	14" x 19" Overlapping Cover - Water	Black	300	2	20NM
114CW	14" x 19" Overlapping Cover - Water	Green	300	2	20NM
Box Only					
113-6	14" x 19" x 6" Straight Wall Extension	Black	49	4.1	20ND
113B	14" x 19" Box	Black	78	6.03	20ND
114-6	14" x 19" x 6" Straight Wall Extension	Green	49	3.86	20ND
114B	14" x 19" Box	Green	78	6.1	20ND
113BB	3/8" x 2-3/4" SS Bolt	Steel	n/a	0.1	20ND

Standard Series 13 in. x 20 in. Rectangular Valve Boxes

Specifications: The NDS Standard Series 13 in. x 20 in. body is tapered and has a minimum wall thickness of 0.250 in. The body has a double wall at the top cover seat area with a minimum thickness of 0.250 in. The cover seat area has 16 structural support ribs on the underside of the seat, each with a minimum thickness of 0.250 in. The bottom of the body has a 0.500 in. flange. The 13 in. x 20 in. cover has an average thickness of 0.250 in. The valve box has a 3/8 in. brass nut for the bolt-down as a standard feature.

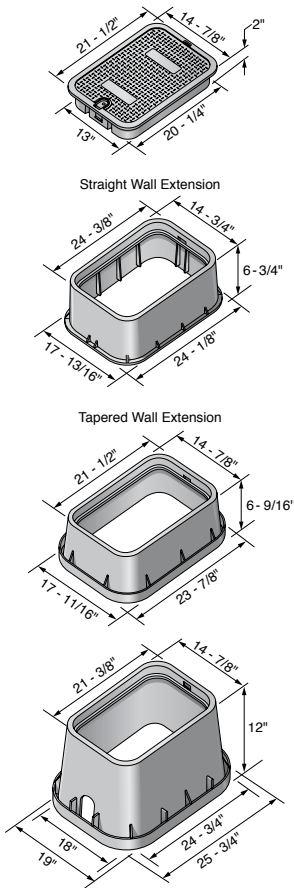

Part No.	Description	Color (Box/Cover)	Pallet Qty.	Weight Ea. (lbs.)	Product Class
Box & Cover					
119	13" x 20" x 6" Jumbo Straight Wall Extension, Overlapping Cover - ICV	Black/Green	32	12	20ND
120	13" x 20" x 6" Jumbo Straight Wall Extension, Overlapping Cover - ICV	Green/Green	32	12	20ND
117BC	13" x 20" Jumbo Box, Overlapping Cover - ICV	Black/Green	56	14	20ND
117BC BLK	13" x 20" Jumbo Box, Overlapping Cover - ICV	Black/Black	56	14	20ND
117BC SAND	13" x 20" Jumbo Box, Overlapping Cover - ICV	Sand/Sand	56	14	20ND
117BCD	13" x 20" Jumbo Box, Drop-in Cover - ICV	Black/Green	56	14	20ND
117BCR	13" x 20" Jumbo Box, Overlapping Cover - Reclaimed Water	Black/Purple	56	14	20ND
117BCS	13" x 20" Jumbo Box, Overlapping Cover - Sewer	Black/Green	56	14	20NM
117BCW	13" x 20" Jumbo Box, Overlapping Cover - Water	Black/Black	56	14	20NM
117PBCR	13" x 20" Jumbo Box, Overlapping Cover - Reclaimed Water	Purple/Purple	56	14	20ND
118BC	13" x 20" Jumbo Box, Overlapping Cover - ICV	Green/Green	56	14	20ND
118BCS	13" x 20" Jumbo Box, Overlapping Cover - Sewer	Green/Green	56	14	20ND
119 SAND	13" x 20" x 6" Jumbo Straight Wall Extension, Overlapping Cover - ICV	Sand/Sand	32	10.95	20ND
119TBC	13" x 20" x 6" Tapered Box, Overlapping Cover - ICV	Black/Green	56	11.15	20ND
119TBCR	13" x 20" x 6" Tapered Box, Overlapping Cover - Reclaimed Water	Black/Purple	56	11.15	20ND
Cover Only					
117C	13" x 20" Overlapping Cover - ICV	Green	180	5.3	20ND
117C BRN	13" x 20" Overlapping Cover - ICV	Brown	180	5.3	20ND
117C SAND	13" x 20" Overlapping Cover - ICV	Sand	180	5	20ND
117CB	13" x 20" Overlapping Cover - ICV	Black	180	5.3	20ND
117CR	13" x 20" Overlapping Cover - Reclaimed Water	Purple	180	5.3	20ND
117CS	13" x 20" Jumbo Overlapping Cover - Sewer	Green	180	5	20NM
117CW	13" x 20" Overlapping Cover - Water	Black	180	5.3	20NM
Box Only					
117-6	13" x 20" x 6" Jumbo Straight Wall Extension	Black	32	6.88	20NM
117B	13" x 20" Jumbo Box	Black	56	9.65	20ND
118-6	13" x 20" x 6" Jumbo Straight Wall Extension	Green	32	6.88	20ND
113BB	3/8" x 2-3/4" SS Bolt	Steel	n/a	0.1	20ND

6 in. Round Valve Boxes

Specifications: NDS 6 in. round body is tapered and has a minimum wall thickness of 0.130 in. The body has a double wall at the top cover seat area with a minimum thickness of 0.125 in. The bottom of the body has a 0.250 in. flange. The 6 in. round cover has an average thickness of 0.150 in.

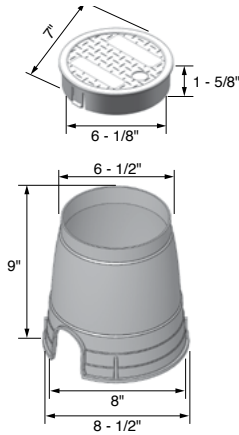

Part No.	Description	Color (Box/Cover)	Pallet Qty.	Weight Ea. (lbs.)	Product Class
Box & Cover					
D108-G	6" Valve Box and Overlapping Cover - ICV	Green/Green	600	1.2	20ND
D109-G	6" Round Box, 6" Round Cover - ICV	Black/Green	600	1.2	20ND
D109-P	6" Round Box, 6" Round Cover - Reclaimed Water	Black/Purple	600	1.21	20ND
D109-GBOX	6" Round Box, 6" Round Cover - ICV	Black/Green	36 Box/ 432 Pal.	1.2	20ND
Cover Only					
D109-GL	6" Round Cover - ICV	Green	600	0.4	20ND
D109-PL	6" Round Cover - Reclaimed Water	Purple	600	0.4	20ND

NDS SureFit™ Round Universal Lids

If you've ever had to find a replacement lid for a round valve box, you know it's not easy. Different brands design their boxes with different dimensions, so a lid that works for one brand may not fit another. NDS SureFit™ Universal Lids are engineered to fit valve round boxes from a variety of manufacturers. Now it is easier to replace broken, missing, or misshapen lids with a proper fit. The SureFit™ Universal Lid is available in two sizes: one size fits 6 in. and 7 in. round valve boxes and the other size fits 10 in. round valve boxes.

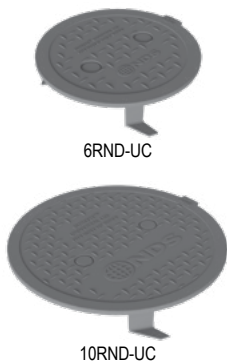

Part No.	Description	Color	Order Qty.	Weight Ea. (lbs.)	Product Class
6RND-UC	Universal Fit for 6" and 7" Round	Green	16	.4	20ND
10RND-UC	Universal Fit for 10" Round	Green	14	.9	20ND

8 in. x 12 in. Oval Valve Boxes

Specifications: NDS 8 in. x 12 in. body is tapered and has a minimum wall thickness of 0.187 in. The body has a double wall at the top cover seat area with a minimum thickness of 0.200 in. The cover seat area has 10 structural support ribs on the underside of the seat, each with a minimum thickness of 0.150 in. The bottom of the body has a 0.375 in. flange. The 8 in. x 12 in. cover shall have an average thickness of 0.150 in.

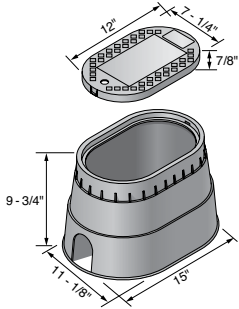

Part No.	Description	Color (Box/Cover)	Pallet Qty.	Weight Ea. (lbs.)	Product Class
Box & Cover					
M2-SG	8" x 12" Box, Drop-in Cover - Control Valve	Black/Green	132	4	20ND
Cover Only					
M2-SG-LID	8" x 12", Drop-in Cover	Green	132	0.719	20ND

8 in. x 14 in. Oval Valve Boxes

Specifications: NDS 8 in. x 14 in. body is tapered and has a minimum wall thickness of 0.187 in. The body has a double wall at the top cover seat area with a minimum thickness of 0.200 in. The cover seat area has 10 structural support ribs on the underside of the seat, each with a minimum thickness of 0.150 in. The bottom of the body has a 0.375 in. flange. The 8 in. x 14 in. cover has an average thickness of 0.150 in.

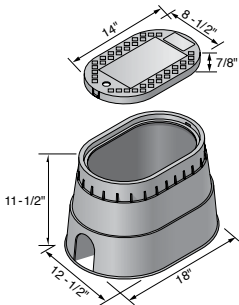

Part No.	Description	Color (Box/Cover)	Pallet Qty.	Weight Ea. (lbs.)	Product Class
Box & Cover					
M4-SG	8" x 14" Box, Drop-in Cover - Control Valve	Black/Green	96	4.6	20ND

We put water in its place™

10 in. x 15 in. Rectangular Valve Boxes

Specifications: NDS 10 in. x 15 in. x 10 in. body is tapered and has a minimum wall thickness of 0.130 in. The body has a double wall at the top cover seat area with a minimum thickness of 0.200 in. The cover seat area has 12 structural support ribs on the underside of the seat, each with a minimum thickness of 0.130 in. The bottom of the body has a 0.750 in. flange. The D1000 cover has an average thickness of 0.187 in. NDS D1000 valve boxes and covers are injection molded of structural foam recycled polyolefin material with a melt index between 10-12. Coloring and UV stabilizers are added, along with processing lubricants when needed.

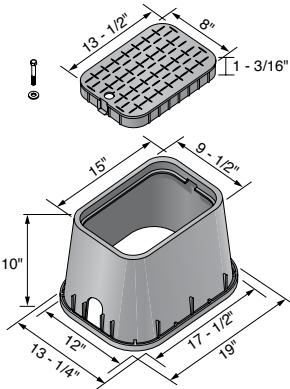

Part No.	Description	Color (Box/Cover)	Pallet Qty.	Weight Ea. (lbs.)	Product Class
Box & Cover					
D1000-SG	10" x 15" x 10" Box, Drop-in Cover - ICV	Black/Green	96	4.8	20ND
Cover Only					
D1000-SGL	10" x 15" Drop-in Cover - ICV	Green	360	1.4	20ND
Box Only					
D1000-B/O	10" x 15" x 10" Box	Black	96	3.4	20ME

Automatic Meter Reader (AMR) Boxes

14 in. x 19 in. AMR Meter Boxes & Covers, standard commercial grade

Specifications: NDS 14 in. x 19 in. x 12 in. body is tapered and has a minimum wall thickness of 0.250 in. The body has a double wall at the top cover seat area with a minimum thickness of 0.187 in. The cover seat area has 30 structural support ribs on the underside of the seat, each with a minimum thickness of 3/16 in. The bottom of the body has a 1 in. flange. The 14 in. x 19 in. cover has a minimum thickness of 0.250 in.

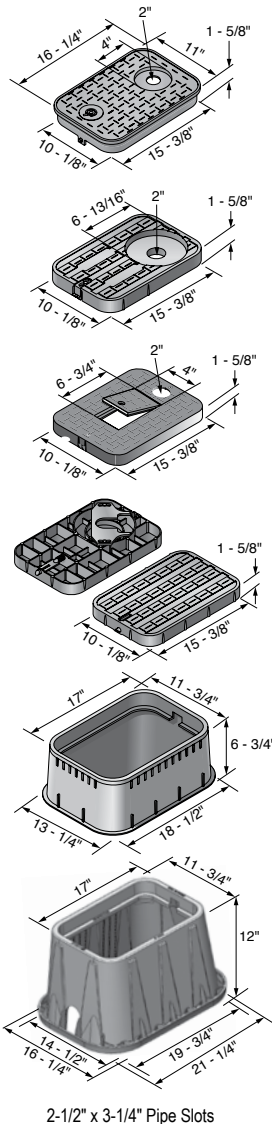

Part No.	Description - Marking	Color (Box/Cover)	Pallet Qty.	Weight Ea. (lbs.)	Product Class
Drop-in Box & Cover					
D12-BAMR	14" x 19" x 12" Box, Drop-in Locking Solid Plastic, Single Bottom Mount AMR Bracket Cover - Water Meter	Black/Black	72	8.90	20ME
D12-TAMR	14" x 19" x 12" Box, Drop-in Locking Solid Plastic, Single 2" AMR/TR Hole with 7" Top Recess Cover - Water Meter	Black/Black	72	9.22	20ME
D1200-DITR	14" x 19" x 12" Box, Drop-in Solid Plastic, Single 2" AMR/TR Hole Cover - Water Meter	Black/Black	72	9.00	20ME
Drop-in Cover Only					
D12-BAMRL	14" x 19" Drop-in Locking Solid Plastic, Single Bottom Mount AMR Bracket Cover - Water Meter	Black	100	2.10	20ME
D12-TAMRL	14" x 19" Drop-in Locking Solid Plastic, Single 2" AMR/TR Hole with 7" Top Recess Cover - Water Meter	Black	100	2.42	20ME
D1200-DICIRTRL	14" x 19" x 12" Drop-in Meter Reader with Cast Iron Reader Cover, Single 2" AMR/TR Hole - Water Meter	Black	216	3.56	20ME
D1200-DITRL	14" x 19" Drop-in Solid Plastic, Single 2" AMR/TR Hole Cover - Water Meter	Black	100	2.20	20ME
Overlapping Box & Cover					
D12AMR-OLLOCTRBLU	14" x 19" x 12" Box, Overlapping Locking Solid Plastic, Single 2" AMR/TR Hole with 4" Top Recess Cover - Water Meter	Black/Blue	72	7.79	20ME
Overlapping Cover Only					
D12AMR-OLLOCL	14" x 19" Overlapping Locking Solid Plastic, Single 4" Top Recess Cover - Water Meter	Black	100	2.80	20ME
D12AMR-OLLOCTRL	14" x 19" Overlapping Locking Solid Plastic, Single 2" AMR/TR Hole with 4" Top Recess Cover - Water Meter	Black	100	2.80	20ME
D12AMR-OLLOCTRBLUL	14" x 19" Blue Overlapping Locking Solid Plastic, Single 2" AMR/TR Hole with 4" Top Recess Cover - Water Meter	Blue	100	2.80	20ME
Box Only					
D1200-B/O	14" x 19" x 12" Box	Black	72	6.80	20ME
D600E-EXT	14" x 19" x 6" Extension	Black	42	4.20	20ME
D1800-B/O	14" x 19" x 18" Box	Black	48	10.00	20ME

13 in. x 20 in. AMR Boxes & Covers (Dual AMR Boxes for D1200 Lids), standard commercial grade

Specifications: The 13 in. x 20 in. body is tapered and has a minimum wall thickness of 0.250 in. The body has a double wall at the top cover seat area with a minimum thickness of 0.187 in. The cover seat area has 30 structural support ribs on the underside of the seat, each with a minimum thickness of 3/16 in. The bottom of the body has a 1 in. flange. The 14 in. x 19 in. cover has an average thickness of 0.250 in.

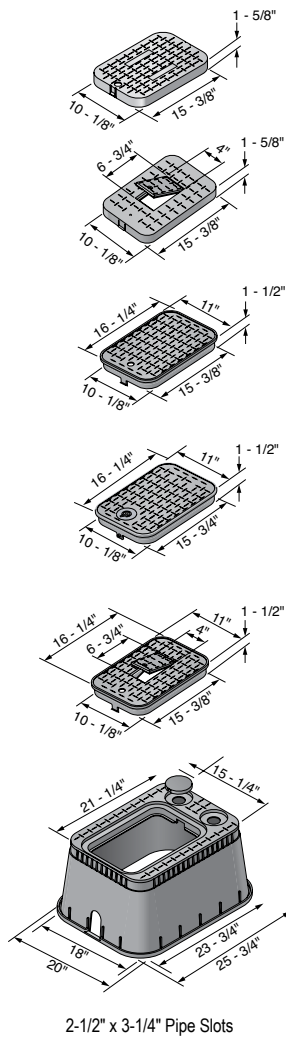

Part No.	Description - Marking	Color (Box/Cover)	Pallet Qty.	Weight Ea. (lbs.)	Product Class
Drop-in Box & Cover					
D15AMR2-DI	13" x 20" x 12" Jumbo AMR Box, Drop-in Solid Plastic Cover - Water Meter	Black/Black	48	16.20	20ME
D15AMR2-DOULSB	13" x 20" x 12" Jumbo AMR Box, Overlapping Cover with Dual Pipe Slots on Reader End - Water Meter	Black/Black	48	16.00	20ME
Drop-in Cover Only					
D1200-DISBL	14" x 19" Drop-in Solid Plastic Cover - Water Meter	Black	216	2.20	20ME
D1200-OLSPL	D1200-OLSPL 14" x 19" Overlapping Solid Plastic Cover - Reclaimed Water	Purple	216	2.14	20ME
D1200-DICIRLID	14" x 19" Drop-in Meter Reader Plastic with Cast Iron Reader Cover - Water Meter	Black	216	3.40	20ME
Overlapping Cover Only					
D1200-OLSBL	14" x 19" Overlapping Solid Plastic Cover - Water Meter	Black	216	2.40	20ME
D1200-OLSPL	14" x 19" Overlapping Solid Plastic Cover - Reclaimed Water	Purple	216	2.40	20ME
D1200-OLLOCBLD	14" x 19" Overlapping Locking Solid Plastic Cover - Water Meter	Black	100	2.60	20ME
Box Only					
D15AMR2-B/O	13" x 20" x 12" Jumbo AMR Box with No Pipe Slots	Black	48	12.09	20ME
D15AMR2-DU B/O	13" x 20" x 12" Jumbo AMR Box with Dual Pipe Slots Reader End	Black	48	10.20	20ME
D15AMR2-PS B/O	Jumbo AMR Box with Pipe Slot on Each End	Black	48	10.20	20ME

13 in. x 20 in. Jumbo Boxes & AMR Covers, standard commercial grade

Specifications: The 13 in. x 20 in. body is tapered and has a minimum wall thickness of 0.250 in. The body has a double wall at the top cover seat area with a minimum thickness of 0.187 in. The cover seat has 56 structural support ribs on the underside of the seat, each with a minimum thickness of 1/50 in. The bottom of the body has a 1 in. flange. The 13 in. x 20 in. cover has an average thickness of 0.25 in.

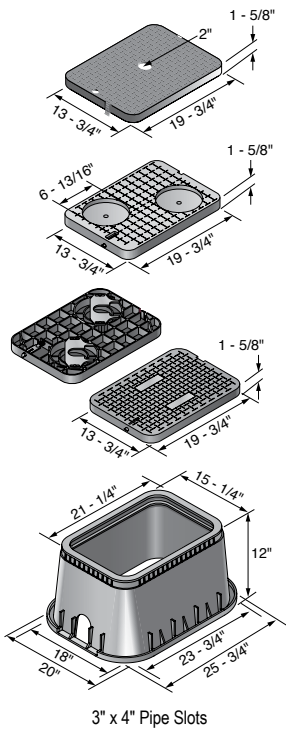

Part No.	Description - Marking	Color (Box/Cover)	Pallet Qty.	Weight Ea. (lbs.)	Product Class
Drop-in Box & Cover					
D15-BAMR	13" x 20" x 12" Jumbo Box, Drop-in Locking Solid Plastic with Double Bottom Mount AMR Brackets Cover - Water Meter	Black/Black	48	24.40	20ME
D15DU-BAMR	13" x 20" x 12" Dual Pipe Slot Box, Drop-in Locking Solid Plastic with Double Bottom Mount AMR Brackets Cover - Water Meter	Black/Black	48	23.91	20ME
D1500-DISBTR	13" x 20" x 12" Jumbo Box, Drop-in Solid Plastic with Single Custom AMR/TR Hole Cover - Water Meter	Black/Black	48	13.20	20ME
Drop-in Cover Only					
D15-BAMRL	13" x 20" Drop-in Locking Solid Plastic with Double Bottom Mount AMR Brackets Cover - Water Meter	Black	96	15.00	20ME
Box Only					
D1500-B/O	13" x 20" x 12" Jumbo Box with Pipe Slot at Each End	Black	48	9.40	20ME
D1500-DUB/O	13" x 20" x 12" Dual Pipe Slot Box (2 Slots at One End, 1 Slot at Opposite End)	Black	48	8.91	20ME
D750E-EXT	13" x 20" x 6" Extension	Black	36	5.60	20ME

Meter Boxes

D109 Meter Boxes, standard commercial grade

Specifications: The 6 in. round body is tapered and has a minimum wall thickness of 0.13 in. The body has a double wall at the top cover seat area with a minimum thickness of 0.125 in. The bottom of the body has a 0.250 in. flange. The 6 in. round cover has an average thickness of 0.15 in.

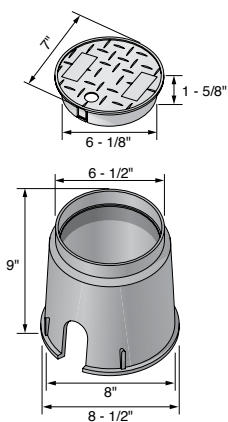

2-1/4" x 2-3/4" Pipe Slots

Part No.	Description - Marking	Color (Box/Cover)	Pallet Qty.	Weight Ea. (lbs.)	Product Class
Box & Cover					
D109-B	6" Round Box, Overlapping Solid Plastic Cover - Water Meter	Black/Black	36 Box/ 432 Pal.	1.21	20ME
D109-P	6" Round Box, Overlapping Solid Plastic Cover - Reclaimed Water	Purple/Purple	36 Box/ 432 Pal.	1.21	20ND
Cover Only					
D109-PL	6" Round Overlapping Solid Plastic Cover - Reclaimed Water	Purple	600	0.40	20ND

D1000, standard commercial grade

Specifications: NDS D1000 meter boxes have a 10" x 15" x 10" body that is tapered and has a minimum wall thickness of 0.13". The body has a double wall at the top cover seat area with a minimum thickness of 0.20". The cover seat area has 12 structural support ribs on the underside of the seat, each with a minimum thickness of 0.13". The bottom of the body has a 0.75" flange.

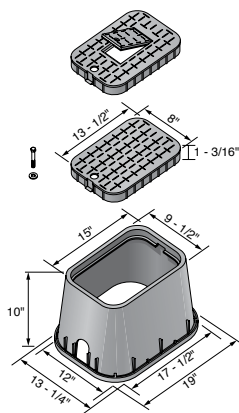

2" x 3" Pipe Slot

Part No.	Description - Marking	Color (Box/Cover)	Pallet Qty.	Weight Ea. (lbs.)	Product Class
Drop-in Box & Cover					
D1000-SB	10" x 15" x 10" Box, Drop-in Solid Plastic Cover - Water Meter	Black/Black	96	5	20ME
D1000-RB	10" x 15" x 10" Box, Drop-in Meter Reader Plastic with Plastic Reader Cover - Water Meter	Black/Black	96	5	20ME
Drop-in Cover Only					
D1000-SBL	10" x 15" Drop-in Meter Solid Plastic Cover - Water Meter	Black	300	1.4	20ME
D1000-RBL	10" x 15" Drop-in Meter Reader with Plastic Reader Cover - Water Meter	Black	300	1.6	20ME

D1200 Meter Boxes, standard commercial grade

Specifications: NDS D1200 meter boxes have a 14 in. x 19 in. x 12 in. body is tapered and has a minimum wall thickness of 0.25 in. The body has a double wall at the top cover seat area with a minimum thickness of 0.187 in. The cover seat area has 30 structural support ribs on the underside of the seat, each with a minimum thickness of 3/16 in. The bottom of the body has a 1 in. flange. The D1200 cover has a minimum thickness of 0.250 in.

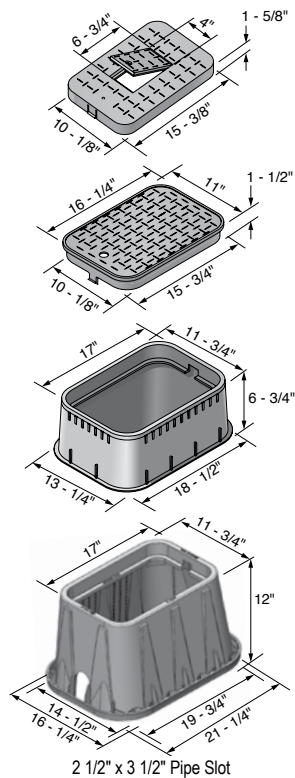

Part No.	Description - Marking	Color (Box/Cover)	Pallet Qty.	Weight Ea. (lbs.)	Product Class
Drop-in Box & Cover					
D1200-DISB	14" x 19" x 12" Box, Drop-in Solid Plastic Cover - Water Meter	Black/Black	72	9.00	20ME
D1200-DISBSWR	14" x 19" x 12" Box, Drop-in Solid Plastic Cover - Sewer	Black/Black	72	9.00	20ME
D1200-DISGSWR	14" x 19" x 12" Box, Drop-in Solid Plastic Cover - Sewer	Black/Green	72	9.00	20ME
D1200-DISBLU	14" x 19" x 12" Box, Drop-in Solid Plastic Cover - Water Meter	Black/Blue	72	9.00	20ME
D1200-DIRB	14" x 19" x 12" Box, Drop-in Plastic Cover with Plastic Meter Reader - Water Meter	Black/Black	72	9.00	20ME
D1200-DIBLRD	14" x 19" x 12" Box, Drop-in Plastic Cover with Plastic Meter Reader - Water Meter	Black/Blue	72	9.00	20ME
D1200-DIRG	14" x 19" x 12" Box, Drop-in Plastic Cover with Plastic Meter Reader - Water Meter	Black/Green	72	9.00	20ME
D1200-DICIR	14" x 19" x 12" Box, Drop-in Plastic Cover with Cast Iron Meter Reader - Water Meter	Black/Black	72	10.20	20ME
D1200-DICIRBLU	14" x 19" x 12" Box, Drop-in Plastic Cover with Cast Iron Meter Reader - Water Meter	Black/Blue	72	10.20	20ME
D1200P-DICIRP	14" x 19" x 12" Box, Drop-in Plastic Cover with Cast Iron Meter Reader - Reclaimed Water	Purple/Purple	72	10.20	20ME

D1200 Meter Boxes

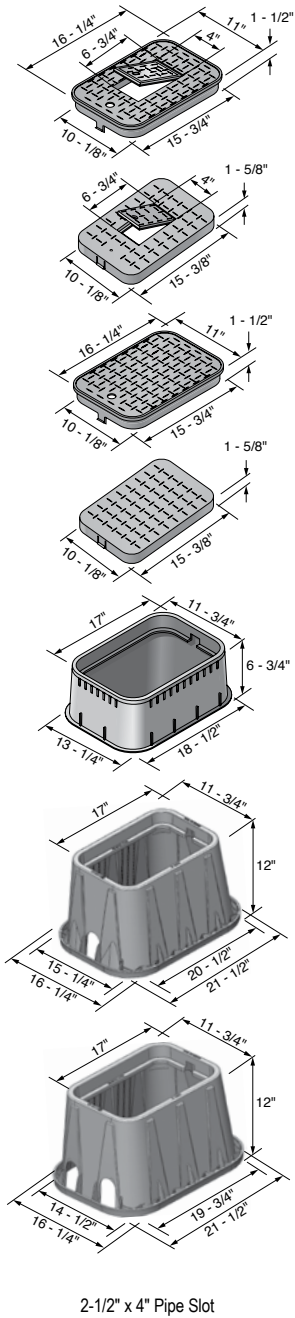

Part No.	Description - Marking	Color (Box/Cover)	Pallet Qty.	Weight Ea. (lbs.)	Product Class
Overlapping Box & Cover					
D1200-OLSB	14" x 19" x 12" Box, Overlapping Solid Plastic Cover - Water Meter	Black/Black	72	9.20	20ME
D1200-OLLOCB	14" x 19" x 12" Box, Overlapping Locking Solid Plastic Cover - Water Meter	Black/Black	72	9.40	20ME
D1200-OLRB	14" x 19" x 12" Box, Overlapping Plastic Cover with Plastic Meter Reader - Water Meter	Black/Black	72	9.20	20ME
D1200-CI	14" x 19" x 12" Box, Overlapping Solid Cast Iron Cover - Water Meter	Black/Black	72	19.00	20ME
D1200-OLCIR	14" x 19" x 12" Box, Overlapping Plastic Cover with Cast Iron Meter Reader - Water Meter	Black/Black	72	10.60	20ME
D1200-CICIR	14" x 19" x 12" Box, Overlapping Cast Iron Cover with Cast Iron Meter Reader - Water Meter	Black/Black	72	10.28	20ME
Drop-in Cover Only					
D1200-DISBL	14" x 19" Drop-in Solid Plastic Cover - Water Meter	Black	216	2.20	20ME
D1200-DISBLUL	14" x 19" Drop-in Solid Plastic Cover - Water Meter	Blue	216	2.20	20ME
D1200-DISBSWRL	14" x 19" Drop-in Solid Plastic Cover - Sewer	Black	216	2.20	20ME
D1200-DISGSWRL	14" x 19" Drop-in Solid Plastic Cover - Sewer	Green	216	2.20	20ME
D1200-DIRBL	14" x 19" Drop-in Plastic Cover with Plastic Meter Reader - Water Meter	Black	216	2.20	20ME
D1200-DICIRBLUL	14" x 19" Drop-in Plastic Cover with Cast Iron Meter Reader - Water Meter	Blue	216	2.40	20ME
D1200-DIBLRDL	14" x 19" Drop-in Plastic Cover with Plastic Meter Reader - Water Meter	Blue	216	2.20	20ME
D1200-DICIRLID	14" x 19" Drop-in Plastic Cover with Cast Iron Meter Reader - Water Meter	Black	216	3.40	20ME
Overlapping Cover Only					
D1200-OLSBL	14" x 19" Overlapping Solid Plastic Cover - Water Meter	Black	216	2.40	20ME
D1200-OLLOCBLD	14" x 19" Overlapping Locking Solid Plastic Cover - Water Meter	Black	100	2.60	20ME
D1200-OLBLL	14" x 19" Overlapping Solid Plastic Cover - Water Meter	Blue	216	2.40	20ME
D1200-CIL	14" x 19" Overlapping Solid Cast Iron Cover - Water Meter	Black	216	12.20	20ME
D1200-OLCIR LD	14" x 19" Overlapping Plastic Cover with Cast Iron Meter Reader - Water Meter	Black	216	3.80	20ME
Box Only					
D1200-B/O	14" x 19" x 12" Box	Black	72	6.80	20ME
D1200-DUB/O	14" x 19" x 12" Dual Pipe Slot Box	Black	72	6.80	20ME
D600E-EXT	14" x 19" x 6" Extension Only	Black	42	4.20	20ME

D1500 Meter Boxes, standard commercial grade

Specifications: NDS 1500 meter boxes have a body that has a double wall at the top cover seat area with a minimum thickness of 0.187 in. The cover seat area has 30 structural support ribs on the underside of the seat, each with a minimum thickness of 1/50 in. The bottom of the body has a 1 in. flange. The 13 in. x 20 in. cover has an average thickness of 0.250 in.

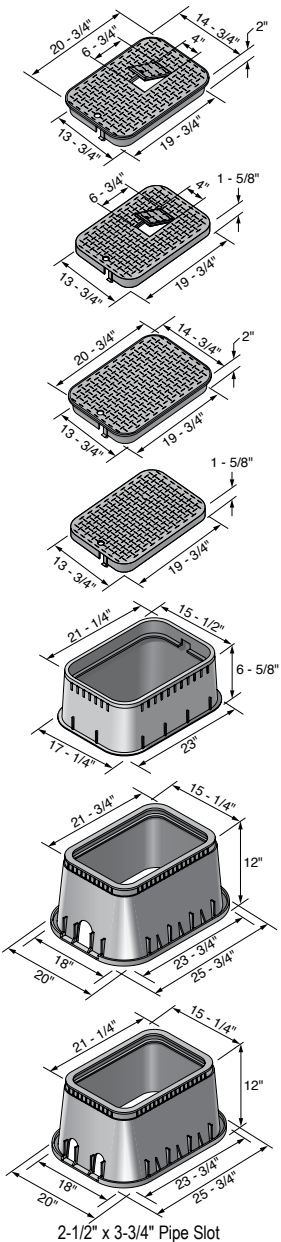

Part No.	Description - Marking	Color (Box/Cover)	Pallet Qty.	Weight Ea. (lbs.)	Product Class
Drop-in Box & Cover					
D1500-DISB	13" x 20" x 12" Jumbo Box, Drop-in Solid Plastic Cover - Water Meter	Black/Black	48	13.20	20ME
D1500-DUDISB	13" x 20" x 12" Dual Pipe Slot Jumbo Box, Drop-in Solid Plastic Cover - Water Meter	Black/Black	48	13.49	20ME
D1500-DIRB	13" x 20" x 12" Jumbo Box, Drop-in Plastic Cover with Plastic Meter Reader - Water Meter	Black/Black	48	13.20	20ME
D1500-DUDIRB	13" x 20" x 12" Dual Pipe Slot Jumbo Box, Drop-in Plastic Cover with Plastic Meter Reader - Water Meter	Black/Black	48	13.49	20ME
D1500-DICIR	13" x 20" x 12" Jumbo Box, Drop-in Plastic Cover with Cast Iron Meter Reader - Water Meter	Black/Black	48	14.40	20ME
D1500-DICIRBLU	13" x 20" Drop-in Meter Reader Cover, Drop-in Plastic Cover with Cast Iron Meter Reader - Water Meter	Black/Blue	96	5.00	20ME
D1500-DUDICIR	13" x 20" x 12" Dual Pipe Slot Jumbo Box, Drop-in Plastic Cover with Cast Iron Meter Reader - Water Meter	Black/Black	48	13.20	20ME
D1500-DIRBLU	13" x 20" Drop-in Plastic Cover with Plastic Meter Reader - Water Meter	Blue/Blue	48	11.60	20ME
Overlapping Box & Cover					
D1500-OLSB	13" x 20" x 12" Jumbo Box, Overlapping Solid Plastic Cover - Water Meter	Black/Black	48	13.20	20ME
Drop-in Cover Only					
D1500-DISBL	13" x 20" Drop-in Solid Plastic Cover - Water Meter	Black	96	3.80	20ME
D1500-DIRBL	13" x 20" Drop-in Plastic Cover with Plastic Meter Reader - Water Meter	Black	96	3.80	20ME
D1500-DICIR LD	13" x 20" Drop-in Plastic Cover with Cast Iron Meter Reader - Water Meter	Black	96	5.00	20ME
Overlapping Cover Only					
D1500-OLSBL	13" x 20" Jumbo Overlapping Solid Plastic Cover - Water Meter	Black	96	3.80	20ME
Box Only					
D1500-B/O	13" x 20" x 12" Jumbo Box	Black	48	9.40	20ME
D1500-DUB/O	13" x 20" x 12" Dual Pipe Slot Jumbo Box	Black	48	8.91	20ME
D750E-EXT	13" x 20" x 6" Extension Only	Black	36	5.60	20ME

D1800 Meter Boxes, standard commercial grade

D1800 Meter Boxes are to be used with D1200 covers, see page 178 and page 183.

Specifications: NDS meter boxes have a body that is tapered and has a minimum wall thickness of 0.250 in. The body has a double wall at the top cover seat area with a minimum thickness of 0.22 in. The cover seat area has 26 structural support ribs on the underside of the seat, each with a minimum thickness of 0.12 in. The bottom of the body has a 0.50 in. flange. The 14 in. x 19 in. cover has an average thickness of 0.20 in.

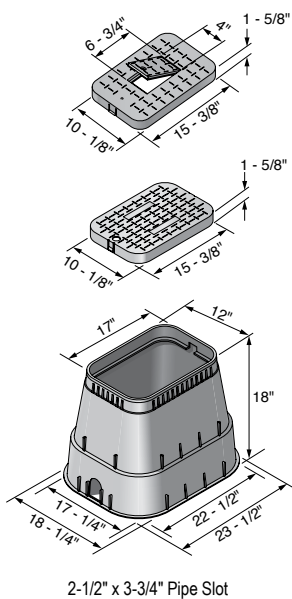

Part No.	Description - Marking	Color (Box/Cover)	Pallet Qty.	Weight Ea. (lbs.)	Product Class
Drop-in Box & Cover					
D1800-DISB	14" x 19" x 18" Box, Drop-in Solid Plastic Cover - Water Meter	Black/Black	48	12.20	20ME
D1800-DIRB	14" x 19" x 18" Box, Drop-in Plastic Cover with Plastic Meter Reader - Water Meter	Black/Black	48	12.20	20ME
D1800-DICIR	14" x 19" x 18" Box, Drop-in Plastic Cover with Cast Iron Meter Reader - Water Meter	Black/Black	48	13.40	20ME
Overlapping Box & Cover					
D1800-OLSG	14" x 19" Overlapping Cover - ICV	Black/Green	48	12.40	20ME
Drop-in Cover Only					
D1200-DISBL	14" x 19" Drop-in Box Solid Plastic Cover - Water Meter	Black	216	2.20	20ME
D1200-DIRBL	14" x 19" Drop-in Plastic Cover with Plastic Meter Reader - Water Meter	Black	216	2.20	20ME
D1200-DICIRLID	14" x 19" Drop-in Plastic Cover with Cast Iron Meter Reader - Water Meter	Black	216	3.40	20ME
D1200-DISBSWRL	14" x 19" Drop-in Solid Plastic Cover - Sewer	Black	216	2.20	20ME
Box Only					
D1800-B/O	14" x 19" x 18" Box	Black	48	10.00	20ME
D1800-B/O NH	14" x 19" x 18" Box, No Pipe Slots	Black	48	10.00	20ME
D1800-B/O WHT	14" x 19" Box	White	48	10.00	20ME

D2400 Meter Boxes, standard commercial grade

Specifications: NDS 16 in. round meter pits and covers are injection molded of structural foam recycled polyolefin material with a melt index between 10-12. Coloring and UV stabilizers are added, along with processing lubricants when needed. The 16 in. round meter pit body is tapered and has a minimum wall thickness of 0.2615 in. The body has a double wall at the top cover seat area with a minimum thickness of 0.2780 in. The cover seat area has 8 structural support ribs on the underside of the seat, each with a minimum thickness of 0.0995 in. The bottom of the body has a 1/2 in. flange which flares to 1-1/4 in. at bolt hole. The 12-3/8 in. cover has an average thickness of 0.375 in.

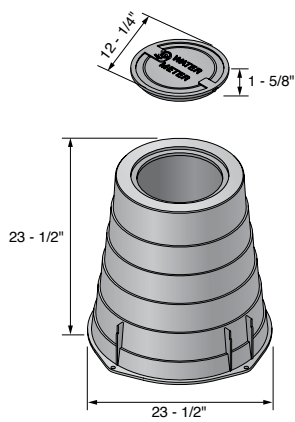

Part No.	Description - Marking	Color (Box/Cover)	Pallet Qty.	Weight Ea. (lbs.)	Product Class
Box & Cover					
D2400-18LOCSB	18" Meter Pit, Overlapping Locking Solid Plastic Cover - Water Meter	Black/Black	40	11.40	20ME
D2400-LOCSB	24" Meter Pit, Overlapping Locking Solid Plastic Cover - Water Meter	Black/Black	52	17.53	20ME
Cover Only					
D2400-LOCSWBL	Overlapping Locking Solid Plastic Cover - Water Meter	Black	52	1.60	20ME
Box Only					
D2400-18 B/O	18" Meter Pit	Black	40	9.80	20ME
D2400-B/O	24" Meter Box	Black	52	14.00	20ME

Meter Box Accessories



Part No.	Description	Color (Box/Cover)	Pallet Qty.	Weight Ea. (lbs.)	Product Class
DKEY	Brass Locking Key, Used with Locking Lids	Brass	1	0.50	20ME

NDS Pro Series Meter Boxes

6 in. Round Meter Boxes, premium commercial grade

Specifications: The NDS 6 in. round meter boxes and covers are injection molded of structural foam polyolefin material with a melt index between 10-12. Coloring and UV stabilizers are added, along with processing lubricants when needed. The 6 in. round body is tapered and has a minimum wall thickness of 0.20 in. The body has a double wall at the top cover seat area with a minimum thickness of 0.13 in. The bottom of the body has a 0.250 in. flange. The 6 in. round cover has an average thickness of 0.187 in.

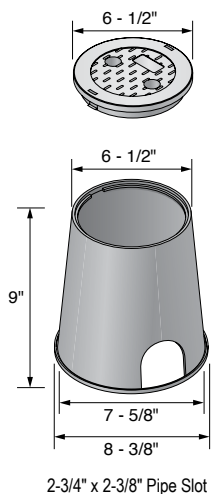

Part No.	Description - Marking	Color (Box/Cover)	Pallet Qty.	Weight Ea. (lbs.)	Product Class
Box & Cover					
107BCW	6" Round Box, Overlapping Solid Plastic Cover - Water	Black/Green	250	1.50	20NM
107BCR	6" Round Box, Overlapping Solid Plastic Cover - Reclaimed Water	Black/Purple	250	1.50	20ND
107PBCR	6" Round Box, Overlapping Solid Plastic Cover - Reclaimed Water	Purple/Purple	250	1.50	20ND
107BCS	6" Round Box, Overlapping Solid Plastic Cover - Sewer	Black/Green	250	1.50	20NM
Cover Only					
107CW	6" Overlapping Solid Plastic Cover - Water	Green	800	0.40	20NM
107CR	6" Overlapping Solid Plastic Cover - Reclaimed Water	Purple	800	0.40	20ND
107CS	6" Overlapping Solid Plastic Cover - Sewer	Green	800	0.40	20NM
Box Only					
107B	6" Round Box	Black	250	1.23	20ND

10 in. Round Meter Boxes, premium commercial grade

Specifications: The NDS 10 in. round meter boxes and covers are injection molded of structural foam polyolefin material with a melt index between 10-12. Coloring and UV stabilizers are added, along with processing lubricants when needed. The 10 in. round body is tapered and has a minimum wall thickness of 0.30 in. The cover seat area has 8 structural support ribs on the underside of the seat, each with a minimum thickness of 0.250 in. The bottom of the body has a 0.50 in. flange. The 10 in. round cover has an average thickness of 0.30 in. The meter box has the patented Universal Locking Mechanism (ULM) that enables various sizes of bolts/screws to secure cover ranging in sizes from 5/16 in. to 3/8 in. diameter and minimum 1-1/2 in. length. Nut is no longer needed. A speed or clip nut slot also exists (clip nut not supplied).

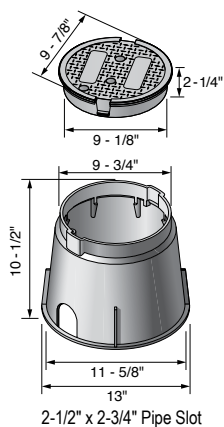

Part No.	Description	Color (Box/Cover)	Pallet Qty.	Weight Ea. (lbs.)	Product Class
Box & Cover					
111BCS	10" Round Box, Overlapping Solid Plastic Cover - Sewer	Black/Green	180	3.00	20NM
212BCS	10" Round Box, Round Overlapping Solid Plastic Cover - Sewer	Green/Green	120	4.50	20PR
Cover Only					
111CS	10" Round Overlapping Solid Plastic Cover - Sewer	Green	300	1.00	20NM

14 in. x 19 in. Meter Boxes, premium commercial grade

Specifications: The NDS 14 in. x 19 in. meter boxes and covers are injection molded of structural foam polyolefin material with a melt index between 10-12. Coloring and UV stabilizers are added, along with processing lubricants when needed. The 14 in. x 19 in. body is tapered and has a minimum wall thickness of 0.250 in. The body has a double wall at the top cover seat area with a minimum thickness of 0.250 in. The cover seat area has 16 structural support ribs on the underside of the seat, each with a minimum thickness of 0.250 in. The bottom of the body has a 0.50 in. flange. The 12 in. x 20 in. cover shall have an average thickness of 0.250 in. The meter box has the patented Universal Locking Mechanism (ULM) that enables various sizes of bolts/screws to secure cover ranging in sizes from 3/8 to 1/2 in. diameter and minimum 2-1/2 in. length. Nut is no longer needed. A speed or clip nut slot also exists (clip nut not supplied). The 6 in. straight wall extensions have a 3/8 in. brass nut for bolt-down as a standard feature.

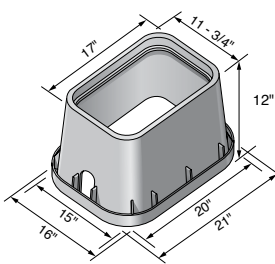
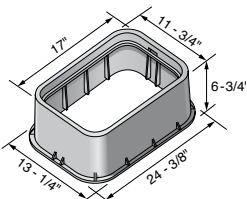
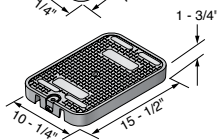
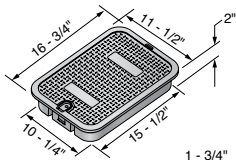
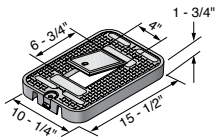
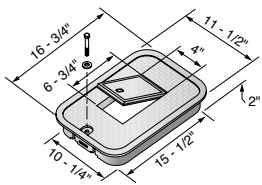

2-3/4" x 2-1/2" Pipe Slot

Part No.	Description - Marking	Color (Box/Cover)	Pallet Qty.	Weight Ea. (lbs.)	Product Class
Drop-in Box & Cover					
113BCDW	14" x 19" x 12" Box, Drop-in Solid Plastic Cover - Water	Black/Black	78	8.00	20NM
113BCDS	14" x 19" x 12" Box, Drop-in Solid Plastic Cover - Sewer	Black/Green	78	8.00	20NM
Overlapping Box & Cover					
113BCW	14" x 19" x 12" Box, Overlapping Solid Plastic Cover - Water	Black/Black	78	9.32	20NM
113BCS	14" x 19" x 12" Box, Overlapping Solid Plastic Cover - Sewer	Black/Green	78	9.32	20NM
113BCE	14" x 19" x 12" Box, Overlapping Solid Plastic Cover - Electrical	Green/Green	78	9.32	20NM
113BCR	14" x 19" x 12" Box, Overlapping Solid Plastic Cover - Reclaimed Water	Black/Purple	78	9.10	20ND
113PBCR	14" x 19" x 12" Box, Overlapping Solid Plastic Cover - Reclaimed Water	Purple/Purple	78	9.29	20ND
113BCM	14" x 19" x 12" Box, Overlapping Plastic Cover with Plastic Meter Reader - Water Meter	Black/Black	78	8.92	20NM
213PBCR	14" x 19" Box, Overlapping Solid Plastic Cover - Reclaimed Water	Purple/Purple	78	9.00	20PR
Overlapping Cover Only					
113CW	14" x 19" Overlapping Solid Plastic Cover - Water	Black	300	2.30	20NM
114CW	14" x 19" Overlapping Solid Plastic Cover - Water	Green	300	2.30	20NM
113CR	14" x 19" Overlapping Solid Plastic Cover - Reclaimed Water	Purple	300	2.50	20ND
113CE	14" x 19" Overlapping Solid Plastic Cover - Electric	Green	300	2.30	20NM
Box Only					
113B	14" x 19" x 12" Box	Black	78	6.00	20NM
113-6	14" x 19" x 6" Extension	Black	49	4.00	20ND
114-6	14" x 19" x 6" Extension	Green	49	3.86	20ND
113BB	3/8" x 2-3/4" SS Bolt	Steel	n/a	0.10	20NM

13 in. x 20 in. Meter Boxes, premium commercial grade

Specifications: The NDS 13 in. x 20 in. meter boxes and covers are injection molded of structural foam polyolefin material with a melt index between 10-12. Coloring and UV stabilizers are added, along with processing lubricants when needed. The 13 in. x 20 in. body is tapered and has a minimum wall thickness of 0.250 in. The body has a double wall at the top cover seat area with a minimum thickness of 0.250 in. The cover seat area has 16 structural support ribs on the underside of the seat, each with a minimum thickness of 0.250 in. The bottom of the body has a 0.50 in. flange. The 13 in. x 20 in. cover has an average thickness of 0.250 in. The meter box has a 3/8 in. brass nut for the bolt-down as a standard feature.

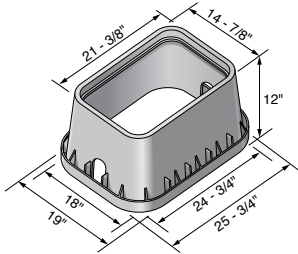
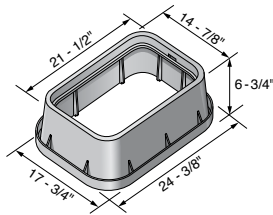
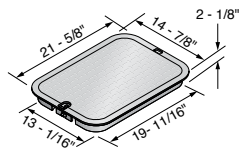

3" x 4" Pipe Slot

Part No.	Description - Marking	Color (Box/Cover)	Pallet Qty.	Weight Ea. (lbs.)	Product Class
Overlapping Box & Cover					
117BCS	13" x 20" x 12" Box, Overlapping Solid Plastic Cover - Sewer	Black/Green	56	14.00	20NM
117B12CW	13" x 20" x 12" Valve Box with Overlapping Cover - Water	Black/Black	56	14.00	20NM
Overlapping Cover Only					
117CW	13" x 20" Overlapping Solid Plastic Cover - Water Meter	Black	180	5.00	20NM
117CS	13" x 20" Overlapping Solid Plastic Cover - Sewer	Green	180	5.00	20NM
Box Only					
117B	13" x 20" x 12" Box, Single Inlet, Single Outlet	Black	56	8.14	20NM
117-6	13" x 20" x 6" Jumbo Extension	Black	32	6.88	20ND
113BB	3/8" x 2-3/4" SS Bolt	Steel	n/a	0.10	20ND

13 in. x 24 in. Meter Boxes, premium commercial grade

Specifications: The NDS 13 in. x 24 in. meter boxes and covers are injection molded of structural foam polyolefin material with a melt index between 10-12. Coloring and UV stabilizers are added, along with processing lubricants when needed. The 13 in. x 24 in. body is tapered and has a minimum wall thickness of 0.27 in. The body has a double wall at the top cover seat area with a minimum thickness of 0.27 in. The cover seat area has 18 structural support ribs on the underside of the seat, each with a minimum thickness of 0.250 in. The bottom of the body has a 1 in. flange. The 13 in. x 24 in. cover has an average thickness of 0.32 in. The meter box has a 3/8 in. Brass nut for the bolt-down as a standard feature.

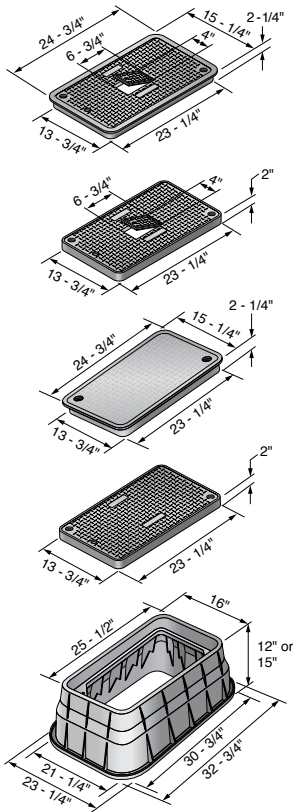

Part No.	Description - Marking	Color (Box/Cover)	Pallet Qty.	Weight Ea. (lbs.)	Product Class
Drop-in Box & Cover					
121BCDWB	13" x 24" x 12" Box, Bolt-Down Drop-in Solid Plastic Cover - Water	Black/Black	12	22.78	20NM
121BCDMCIFB	13" x 24" x 12" Box, Bolt-Down Drop-in Plastic Cover with Cast Iron Meter Reader - Water Meter	Black/Black	12	23.13	20NM
125BCDMCIFB	13" x 24" x 15" Box, Bolt-Down Drop-in Plastic Cover with Cast Iron Meter Reader - Water Meter	Black/Black	12	26.13	20NM
Overlapping Box & Cover					
125PBCRB	13" x 24" x 15" Box, Bolt-Down Overlapping Solid Plastic Cover - Reclaimed Water	Purple/Purple	12	26.44	20ND
Drop-in Cover Only					
121CDMCI	13" x 24" Drop-in Plastic Cover with Cast Iron Meter Reader - Water Meter	Black	125	7.13	20NM
Box Only					
325B	13" x 24" x 15" Box	Black	12	19.00	20NM

17 in. x 30 in. Meter Boxes, premium commercial grade

Specifications: The NDS 17 in. x 30 in. meter boxes and covers are injection molded of structural foam polyolefin material with a melt index between 10-12. Coloring and UV stabilizers are added, along with processing lubricants when needed. The 17 in. x 30 in. body is tapered and has a minimum wall thickness of 0.32 in. The body has a double wall at the top cover seat area with a minimum thickness of 0.32 in. The cover seat area has 20 structural support ribs on the underside of the seat, each with a minimum thickness of 0.250 in. The bottom of the body has a 1 in. flange. The 17 in. x 30 in. cover has an average thickness of 0.35 in. The meter box has a 3/8 in. SS Brass for the bolt-down as a standard feature.

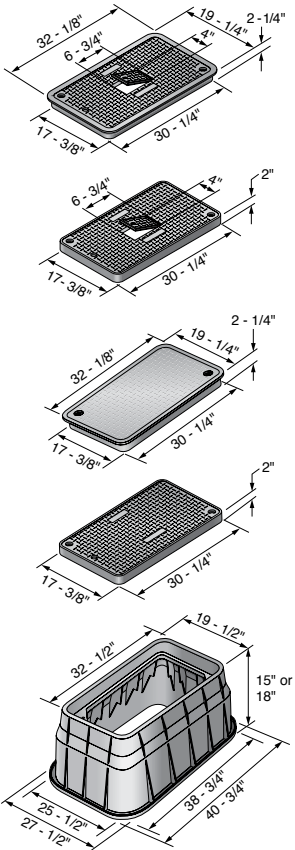

Part No.	Description - Marking	Color (Box/Cover)	Pallet Qty.	Weight Ea. (lbs.)	Product Class
Drop-in Box & Cover					
124BCDWB	17" x 30" x 15" Box, Drop-In Plastic Cover with Plastic Meter Reader – Water Meter	Black/Black	6	34.70	20NM
124BCDMB	17" x 30" x 15" Box, Bolt-Down Drop-in Solid Plastic Cover - Water Meter	Black/Black	6	36.75	20NM
126BCDWB	17" x 30" x 18" Box, Drop-In Solid Plastic Cover with Plastic Meter Reader – Water Meter	Black/Black	10	41.00	20NM
126BCDMCIFB	17" x 30" x 18" Box, Bolt-Down Drop-in Plastic with Cast Iron Reader Cover - Water Meter	Black/Black	10	37.65	20NM
Overlapping Cover Only					
323CR	17" x 30" Overlapping Solid Plastic Cover - Reclaimed Water	Purple	75	11.60	20ND
Drop-in Cover Only					
123CDMCIF	17" x 30" Drop-in Plastic Cover with Cast Iron Meter Reader - Water Meter	Black	75	10.30	20NM
Box Only					
324B BLK	17" x 30" x 15" Box	Black	6	20	20NM
326B BLK	17" x 30" x 18" Box	Black	10	23	20NM

Index, Access Boxes

Part No.	Page	Part No.	Page	Part No.	Page	Part No.	Page	Part No.	Page
6RND-UC	175	111BCR BLK	172	113C	173	117CB	174	311C BLK	166
10RND-UC	175	111BCS	172,187	113CB	173	117C BRN	174	311C ELEC	166
106B	171	111BC SAND	172	113C BRN	173	117CR	174	311CR	166
107B	171,187	111BCW	172	113CE	173,188	117CS	174,189	311CRG	166
107BC	171	111C	172	113CR	173,188	117C SAND	174	311CS	166
107BC BLK	171	111C BLK	172	113CRG	173	117CW	174,189	311CSAND	166
107BCH	171	111C BRN	172	113CS	173	117PBCR	174	311CW	166
107BCR	171,187	111CR	172	113C SAND	173	118-6	174	312B	166
107BCR BLK	171	111CS	172,187	113CW	173,188	118BC	174	312BC	166
107BCS	171,187	111C SAND	172	113PBCR	173,188	118BCS	174	312BCB	166
107BC SAND	171	111CW	172	114-6	173,188	119	174	312BCB ELEC	166
107BC SLV	171	111CW BLK	172	114B	173	119 SAND	174	312BCBS	166
107BCW	171,187	111PBCR	172	114BC	173	119TBC	174	312BC ELEC	166
107C	171	112B	172	114BCS	173	119TBCR	174	312BCRBLK	166
107C BLK	171	112BC	172	114BCW	173	120	174	312BCRG	166
107C BRN	171	112BCB	172	114CW	173,188	121BB	169	312BCS	166
107CH	171	112BCRG	172	115	173	121BCDMCIFB	190	312BCSAND	166
107CR	171,187	112BCS	172	115BCR	173	121BCDWB	190	312BCW	166
107CS	171,187	113	173	115TBC	173	121CDMIF	190	312PB	166
107C SAND	171	113-6	188	115TBCR	173	123CDMIF	191	312PBCBR	166
107CW	171,187	113B	173,188	116	173	124BCDMB	191	312PBCR	166
107EBC	171	113BB 167,168,173,174,188,189		116-SAND	173	124BCDWB	191	313C	167
107PBCR	171,187	113BC	173	116TBC	173	125BCDMCIFB	190	313CB	167
108B	171	113BCBLK	173	116TBC SAND	173	125PBCRB	190	313CBBLK	167
108BC	171	113BCD	173	117-6	174,189	126BCDMB	191	313CBR	167
108BCS	171	113BCDS	188	117B	174,189	126BCDMCIFB	191	313CBRBLK	167
108BCW	171	113BCDW	188	117B12CW	189	212BCS	187	313CBWBLK	167
111B	172	113BCE	173,188	117BC	174	213PBCR	188	313C	167
111BB	172	113BCM	188	117BC BLK	174	311B	166	313CBLK	167
111BC	172	113BCR	173,188	117BCD	174	311BC	166	313C ELEC	167
111BCB	172	113BCRBLK	173	117BCR	174	311BCB	166	313CG ELEC	167
111BC BLK	172	113BCS	173,188	117BCS	174,189	311BCBLK	166	313CR	167
111BCBW	172	113BC SAND	173	117BCSAND	174	311BCR	166	313CRBLK	167
111BC CTN	172	113BCW	173,188	117BCW	174	311BCS	166	313CRG	167
111BCR	172	113BCWG	173	117C	174	311C	166	313CSAND	167

Index, Access Boxes

Part No.	Page	Part No.	Page	Part No.	Page	Part No.	Page	Part No.	Page
313CW	167	318PBCR	168	D12AMR-OLLOCTRBLUL	178	D1200-DIBLRDL	183	D1500-DIRBL	184
314B	167	321B	169	D12AMR-OLLOCTRL	178	D1200-DICIR	182	D1500-DIRBLU	184
314BBLK	167	321BCB	169	D12-BAMR	178	D1200-DICIRBLU	182	D1500-DISB	184
314BC	167	321BCBS	169	D12-BAMRL	178	D1200-DICIRBLUL	183	D1500-DISBL	184
314BCB	167	321BCBW	169	D12-TAMR	178	D1200-DICIRLID	179,183,185	D1500-DISBTR	180
314BCB ELEC	167	322B	169	D12-TAMRL	178	D1200-DICIRTRL	178	D1500-DUB/O	180,184
314BCBRG	167	322BCB	169	D15AMR2-B/O	179	D1200-DIRB	182	D1500-DUDICIR	184
314BCBS	167	322C	169	D15AMR2-DI	179	D1200-DIRBL	183,185	D1500-DUDIRB	184
314BCBSAND	167	322CS	169	D15AMR2-DOULSB	179	D1200-DIRG	182	D1500-DUDISB	184
314BCBW	167	322PBCBR	169	D15AMR2-DU B/O	179	D1200-DISB	182	D1500-OLSB	184
314BCSAND	167	323C	170	D15AMR2-PS B/O	179	D1200-DISBL	179,183,185	D1500-OLSBL	184
314CS	167	323CD	170	D15-BAMR	180	D1200-DISBLU	182	D1800-B/O	178,185
314CW	167	323CD ELEC	170	D15-BAMRL	180	D1200-DISBLUL	183	D1800-B/O NH	185
314PBCBR	167	323CDW	170	D15DU-BAMR	180	D1200-DISBSWR	182	D1800-B/O WHT	185
314PBCR	167	323CR	170,191	D108-G	175	D1200-DISBSWRL	183,185	D1800-DICIR	185
317BCB	168	323CS	170	D109-B	181	D1200-DISGSWR	182	D1800-DIRB	185
317BCBBLK	168	324B	170	D109-G	175	D1200-DISGSWRL	183	D1800-DISB	185
317BCBW	168	324B BLK	170,191	D109-GBOX	175	D1200-DITR	178	D1800-OLSG	185
317C	168	324BCB	170	D109-GL	175	D1200-DITRL	178	D2400-18 B/O	186
317C BLK	168	324BCB-BG	170	D109-P	175,181	D1200-DUB/O	183	D2400-18LOCSB	186
317CR	168	324BCBS	170	D109-PL	175,181	D1200-OLBLL	183	D2400-B/O	186
317CS	168	324BCDB	170	D600E-EXT	178,183	D1200-OLCIR	183	D2400-LOCSB	186
317CSAND	168	325B	169,190	D750E-EXT	180,184	D1200-OLCIR LD	183	D2400-LOCSWBL	186
317CW	168	325BCB	169	D1000-B/O	177	D1200-OLLOCB	183	DKEY	186
318B	168	326B	170	D1000-RB	181	D1200-OLLOCBLD	179,183	M2-SG	176
318B BLK	168	326B BLK	170,191	D1000-RBL	181	D1200-OLRB	183	M2-SG-LID	176
318BC	168	326BCB	170	D1000-SB	181	D1200-OLSB	183	M4-SG	176
318BCB	168	326BCB-BG	170	D1000-SBL	181	D1200-OLSBL	179,183		
318BCBRBLK	168	326BCDB	170	D1000-SG	177	D1200-OLSPL	179		
318BCBRG	168	326BCDB-BG	170	D1000-SGL	177	D1200P-DICIRP	182		
318BCBS	168	326BCDB ELEC	170	D1200-B/O	178,183	D1500-B/O	180,184		
318BCBSAND	168	326BCDBW	170	D1200-CI	183	D1500-DICIR	184		
318CW	168	326PBCBR	170	D1200-CICIR	183	D1500-DICIRBLU	184		
318PB	168	D12AMR-OLLOCL	178	D1200-CIL	183	D1500-DICIR LD	184		
318PBCBR	168	D12AMR-OLLOCTRBLU	178	D1200-DIBLRD	182	D1500-DIRB	184		

For Access Box Technical Information, Refer to Technical Specification documents at ndspro.com/specifications

You Click. You Order. No Waiting.

Getting connected is easy... set up your account online, or call customer service. 800-726-1994.
Se Habla Español.

ndspro.net



The 24 hour online dealer tool that helps you manage your NDS Business

Instant Order Entry, No Wait
Check Discount Schedules
Check Order Status
Pricing Query

Manage Your Account
Invoice Printing
Inventory Query
News Updates



NEW! Shopping Cart
Easy to Use & Convenient

Terms and Conditions of Sale

Terms: Standard terms are NET 30 days. All invoices are to be paid in US Currency. Title and risk of loss pass to buyer upon shipment.

FREIGHT TERMS:

Continental US: Shipments that meet the \$2,000 prepaid freight minimum are DDP (Freight Prepaid). Shipments that do not meet the \$2,000 prepaid freight minimum are FCA NDS distribution center (Freight collect).

Canada: Shipments are CPT- Carriage Paid to customer's location in Canada. (Customer arranges customs clearance into Canada). No returns or refunds except for wrong or damaged product received.

All other international shipments: Shipments are FCA NDS distribution center. (Freight collect) All sales are final, no returns or refunds will be accepted/granted except for wrong product received.

International, Hawaii, Alaska, or Puerto Rico shipments delivered to a US intermediary (such as a freight forwarder or consolidator location in the continental US): Shipments are considered final upon receipt and checking at the US intermediary location

FREIGHT ALLOWANCE:

Prepaid levels are based on shipments to one location only. It is the responsibility of the customer to determine if your purchase order meets the minimum freight allowance required. NDS reserves the right to select the carrier and point of shipment.

Shipments within the Continental US:
Freight prepaid on orders of \$2,000 NET, or more.

Shipments to Canada, Alaska, Puerto Rico:
Freight prepaid on orders of \$2,500 NET, or more.

Shipments to Hawaii:
Freight prepaid on orders of \$3,500 NET, or more.

Shipments to Canada, Alaska, Hawaii, Puerto Rico orders that contain EZ Flow:
Freight prepaid on orders of \$4,000 NET, or more.

Errors & Claims: All claims for shortage in shipment or damaged material must be noted on the "Bill of Lading" and a written request for credit submitted to NDS within 15 days of shipment. NDS responsibility ceases upon delivery to the carrier.

Returned Goods: Returned goods will be accepted only after written approval and shipping instructions are received from NDS. A return goods authorization number is required and must be on all cartons, documents, and correspondence. All returns are subject to a 25% restocking charge, freight cost of returned goods (plus "out freight if applicable"). A higher restocking charge may be assessed against any return requiring extraordinary handling costs.

Minimum Order: \$100.00 minimum order net billing.

Broken Box Charge: A 25% broken box charge will be added for other than full box quantities. 21DI Drip Components, 25DS Dura Slope Channel and 25FC Filcoten Channel are excluded from this policy.

Limited One Year Warranty: The liabilities of NDS are limited solely and exclusively to replacement as set forth in our standard "Statement of Warranty", alone and do not include any liability for incidental, consequential or other damage of any kind whatsoever, whether any claim is based upon theories of contract, warranty, negligence or tort and without any limitations and do not include shipping charges, labor, installation or any other losses or expenses incurred in operation of any replacement specialty item or fitting. NDS drainage products are designed to be used for exterior surface drainage only.

All NDS products are guaranteed against defects resulting from faulty workmanship or materials. Claims for labor costs and other expenses required to replace defective products or repair of any damage resulting from the use thereof will not be allowed by NDS. Our liability is limited to replacement of products acknowledged by NDS to be defective.

Exclusive Warranties and Remedies: The foregoing remedies are exclusive and are given and accepted in lieu of (i) any and all other warranties, expressed or implied, including without limitation the implied warranties of merchantability and fitness for particular purpose; and (ii) any obligation, liability, right, claim or remedy in contract or tort, whether or not arising from NDS, Inc.'s negligence, actual or imputed. The remedies of customer shall be limited to those provided herein to the exclusion of any and all other remedies including, without limitation, incidental or consequential damages. No agreement varying or extending the foregoing warranties or these limitations will be binding on NDS, Inc., unless such is signed in writing by an authorized officer of NDS, Inc.

The liability of NDS, Inc., hereunder shall be limited to restoring to good working order, provided that NDS, Inc., is not required to restore the product to good working order when such failure is due to causes beyond NDS, Inc.'s control, including but not limited to, acts of God, acts of civil or military authority, priorities, strikes, floods, epidemics, war, riots, and other causes that are beyond the manufacturers control.

These provisions are complete and exclusive statements of all terms and conditions between NDS, Inc., and the consumer. These provisions may not be varied, supplemented, qualified or interpreted by any prior course of dealings, written or oral or by trade usage. No NDS, Inc. agent, officer or employee has authority to make any representation, promise or warranty concerning these provisions..

Visit ndspro.com for more information



Visit ndspro.com for:



Videos



Calculators



Quotes



Case Studies



Design Worx



Downloads

ndspro.com

NDS Customer Service
851 N. Harvard Ave., Lindsay, CA 93247
Phone: 800.726.1994 · 559.562.9888
Fax: 800.726.1998 · 559.562.4488
Se Habla Español

Download our
**Mobile App - Search
for NDS Drainage**



California Prop 65 Warning | To meet the requirements of California Proposition 65, it is our responsibility to inform you of the following:
Warning Some products sold contain chemicals known to the state of California to cause cancer, birth defects, or other reproductive harm.
For more information, please go to www.P65Warnings.ca.gov