



NDS[®]
We put water in its place

Your knowledgeable and
trusted partner for the best in
water management solutions

Product Catalog



Residential Stormwater Management
Commercial Stormwater Management
Professional Irrigation
Flow Management

2021

[ndspro.com](https://www.ndspro.com)

MADE IN
USA



Since 1972, NDS has been producing plastic drainage and landscape products. From the beginning, our commitment to leading the industry has been unwavering, leading to remarkable innovations and state-of-the-art products that fit every environment, every schedule, every need.

Today, our commitment to providing one-source solutions has led to the development of superior quality drainage products, landscape products, fittings, valve and meter boxes, and drip and micro irrigation products. No product is added to our line without meeting exhaustive testing and extensive research requirements. Plus, NDS is uniquely able to offer our complete inventory of products from regional warehouses in the US and Puerto Rico. Our goal: one-business-day delivery. Our track record: outstanding.

Take a moment to look through this catalog, noting the depth of our product offering. If you have any questions or to place an order, just call 1-800-726-1994 from 5 a.m. to 5 p.m. PST and let us offer the best solution to you.

THE NDS BRAND PROMISE

NDS is your knowledgeable and trusted partner for the best in water management solutions.

Our products are engineered and produced for performance, durability, ease of installation and the efficient use of resources.

We provide the service and support to ensure that you are successful.

TABLE OF CONTENTS

| | |
|-----|-------------------------|
| 18 | Drainage |
| 52 | Channel & Trench Drains |
| 90 | Permeable Pavers |
| 96 | Landscape |
| 102 | Professional Irrigation |
| 142 | Flow Management |
| 170 | Fittings & Clamps |
| 192 | Valve & Meter Boxes |





NDS products have been a reliable and trusted choice for use on over 500 projects. Never a problem, never a failure.

David Silver
AAA Landscape Specialists, Inc.
President and CEO

We put water in its place



RESIDENTIAL SOLUTIONS

Water Management at Any Scale

Water on Patio/Pool Deck

Channel Drains prevent water pooling on patio or pool deck, potentially causing moss or mildew growth, concrete staining, and dangerous slip hazards. (pp. 52-87)

Flow Management

Ball Valves and Check Valves are integral components of aquatic pump and filter assemblies. (pp. 148-157)

Downspout Runoff

Catch Basin and Grates remove water from downspouts and away from foundations. (pp. 26-35)

Landscape Irrigation

Drip and Micro Irrigation conserve water by delivering it efficiently to plants and turf. See *Professional Irrigation* (pp. 102-139)

Water on Driveway

Channel Drain and Grates collect sheets of water moving across driveways and sidewalks. (pp. 52-87)

Stormwater Detention & Infiltration

NDS® StormChambers® and Flo-Well® provide high-volume detention and infiltration capacity for managing stormwater runoff close to the source. (pp. 14-25)

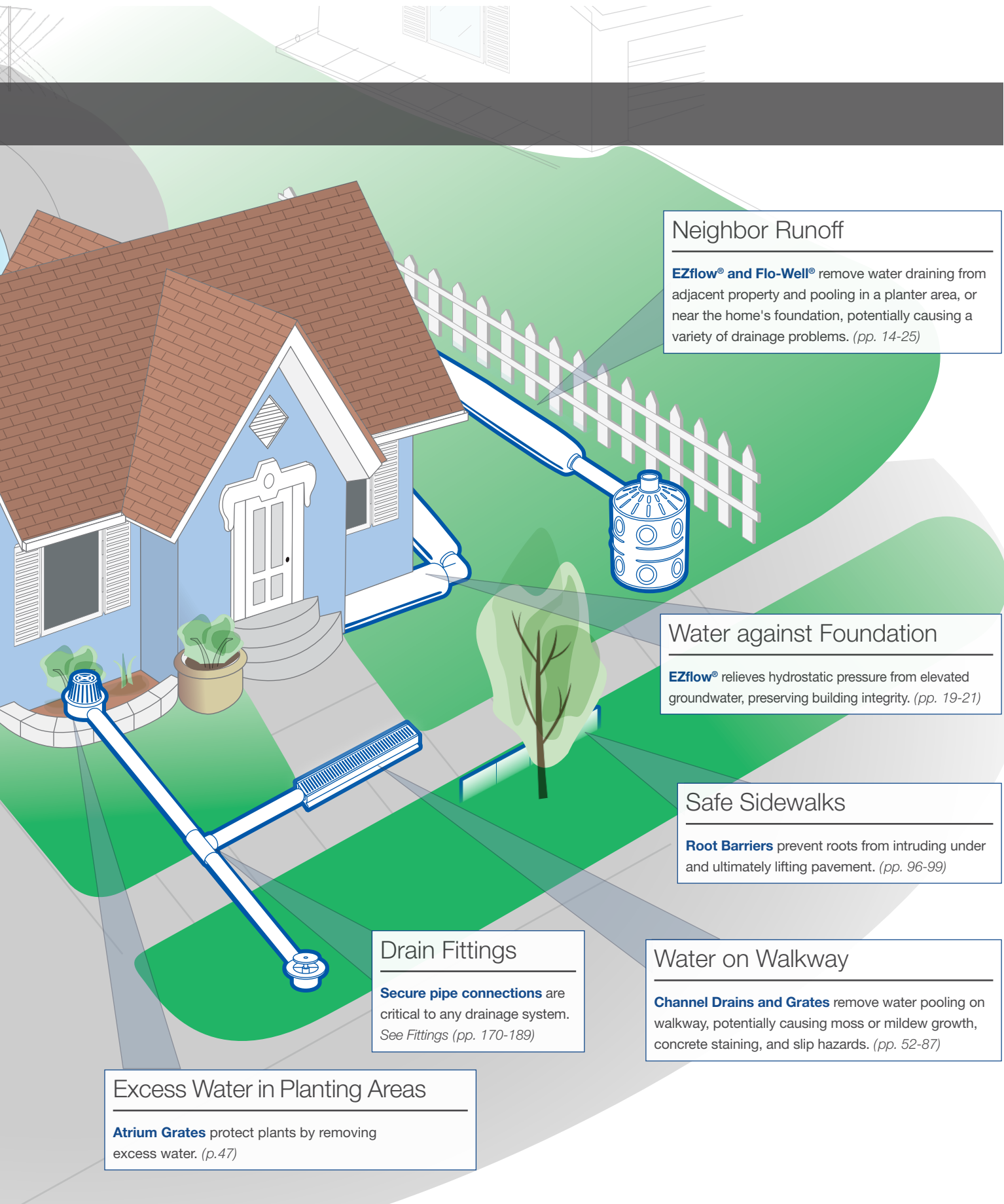

Neighbor Runoff
EZflow® and Flo-Well® remove water draining from adjacent property and pooling in a planter area, or near the home's foundation, potentially causing a variety of drainage problems. (pp. 14-25)

Water against Foundation
EZflow® relieves hydrostatic pressure from elevated groundwater, preserving building integrity. (pp. 19-21)

Safe Sidewalks
Root Barriers prevent roots from intruding under and ultimately lifting pavement. (pp. 96-99)

Drain Fittings
Secure pipe connections are critical to any drainage system. See *Fittings* (pp. 170-189)

Water on Walkway
Channel Drains and Grates remove water pooling on walkway, potentially causing moss or mildew growth, concrete staining, and slip hazards. (pp. 52-87)

Excess Water in Planting Areas
Atrium Grates protect plants by removing excess water. (p.47)

NEIGHBORHOOD SOLUTIONS

Water Management at Any Scale

Reinforced Turf & Gravel

Permeable Paver Systems used in firelanes, service vehicle access ways and overflow parking produce significantly less stormwater runoff than hard surfaces. (pp. 90-95)

Permeable Pavers

EZ Roll™ gravel patios and walkways maintain permeability and reduce runoff. (p. 94)

Stormwater Detention & Infiltration

Using **Dry Wells** and **Infiltration Trenches** is a best management practice for treating stormwater runoff close to its source. (pp. 18-25)

Stormwater Detention & Infiltration

NDS® StormChambers® offer a lower cost alternative to drainage pipes. (pp. 15, 19, 22-23)

Downspout Runoff

Catch Basins and Grates remove stormwater from downspouts and away from foundations and landscaped areas. (pp. 26-35)

Landscape Irrigation

Drip and Micro Irrigation conserve water by delivering it efficiently to plants and turf. See *Professional Irrigation* (pp. 102-139)

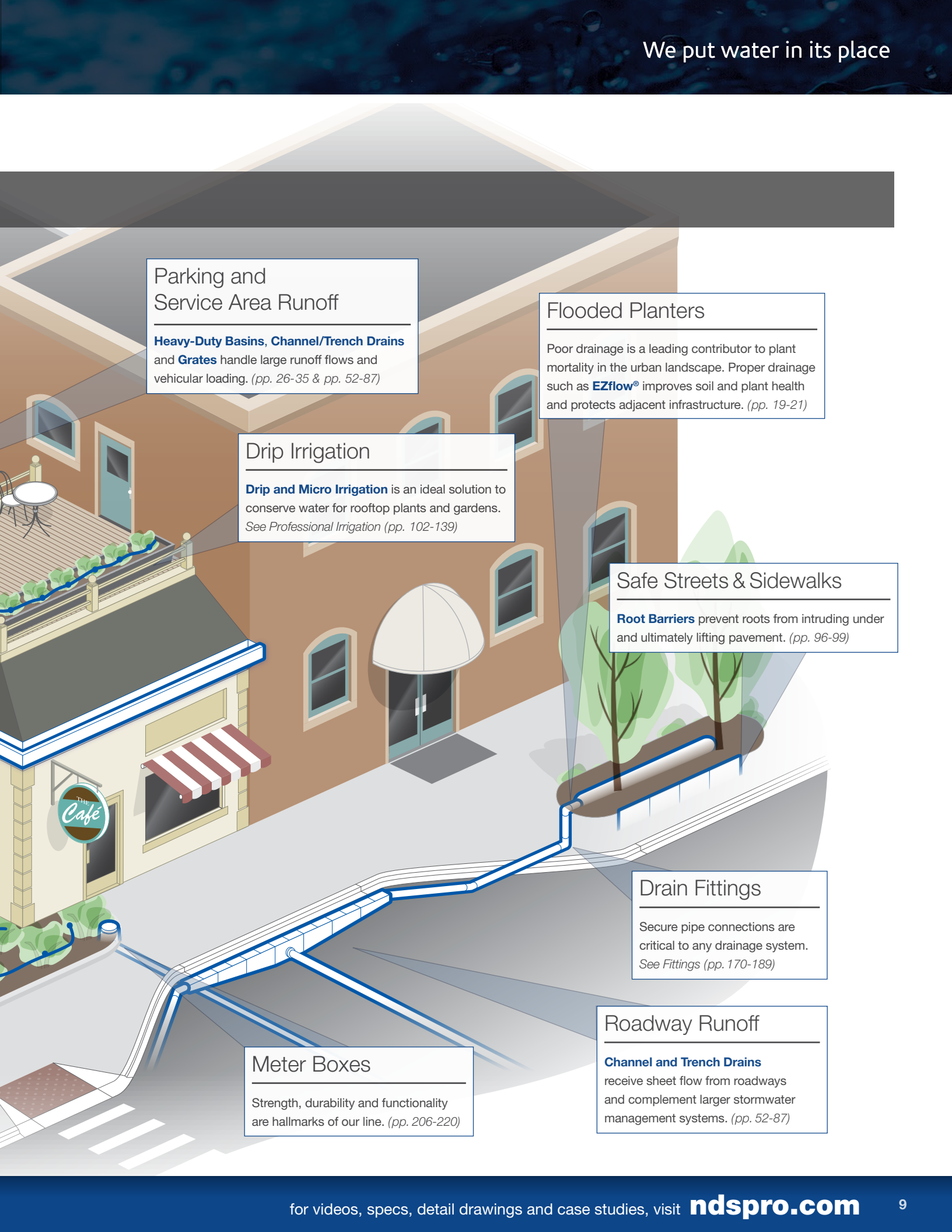

Parking and Service Area Runoff

Heavy-Duty Basins, Channel/Trench Drains and **Grates** handle large runoff flows and vehicular loading. (pp. 26-35 & pp. 52-87)

Flooded Planters

Poor drainage is a leading contributor to plant mortality in the urban landscape. Proper drainage such as **EZflow®** improves soil and plant health and protects adjacent infrastructure. (pp. 19-21)

Drip Irrigation

Drip and Micro Irrigation is an ideal solution to conserve water for rooftop plants and gardens. See *Professional Irrigation* (pp. 102-139)

Safe Streets & Sidewalks

Root Barriers prevent roots from intruding under and ultimately lifting pavement. (pp. 96-99)

Drain Fittings

Secure pipe connections are critical to any drainage system. See *Fittings* (pp. 170-189)

Meter Boxes

Strength, durability and functionality are hallmarks of our line. (pp. 206-220)

Roadway Runoff

Channel and Trench Drains receive sheet flow from roadways and complement larger stormwater management systems. (pp. 52-87)

COMMUNITY SOLUTIONS

Water Management at Any Scale

Large Roof Runoff

High-Capacity Subsurface Detention and Infiltration Systems including NDS® StormChambers® manage large roof runoff volumes in adjacent green areas or under parking lots. (pp. 18-25)

Athletic Field Drainage

Playability after rain events is critical in maintaining field integrity. **EZflow®** is an ideal drainage system for many field types. (pp. 19-21)

Reinforced Turf

Permeable Paver Systems used in grassed access ways produce significantly less stormwater runoff than hard surfaces. (pp. 90-95)

Subsurface Irrigation

Dura Flo™ CV Check Valve Drip Line is the efficient choice for healthy turf. (p. 108-109)

400M Track Runoff

Dura Slope™ EZ-Track™ System uses radius couplings to easily make the turn on running tracks, eliminating difficult miter cuts. (p. 77)

Landscape Irrigation

Drip and Micro Irrigation conserves water by delivering it efficiently to plants and turf. See *Professional Irrigation* (pp. 102-139)

Courtyard Runoff

Catch Basins (pp. 26-35) and **Channel Drains** (pp. 52-87) keep pedestrian areas well-drained.

Pool Deck Drainage

Channel and **Trench Drains** keep the pool deck dry and safe with many decorative and heel-proof grate options. (pp. 52-87)

Safe Pool Deck

Root Barriers preserve the integrity of adjacent paved areas by preventing root intrusion. (pp. 96-99)

Reinforced Gravel with Delineators

EZ Roll™ gravel parking areas maintain permeability and reduce runoff, while **EZ Marker™** clearly delineates parking stalls. (pp. 94-95)

Flow Management

Ball and Check Valves are integral components of aquatic pump and filter assemblies. (pp. 148-157)



DRAINAGE

From your backyard patio to the neighborhood aquatic center, from the factory floor to a professional sports facility, NDS offers the right drainage solutions.

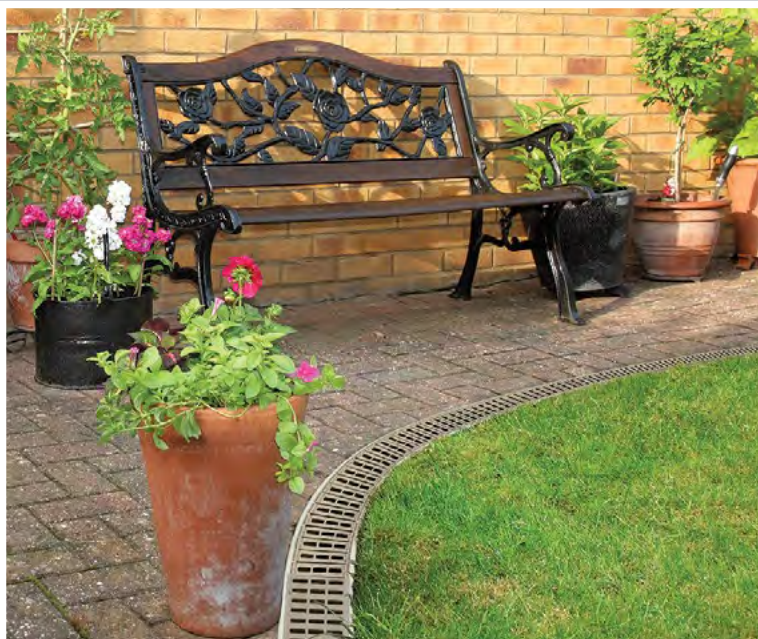
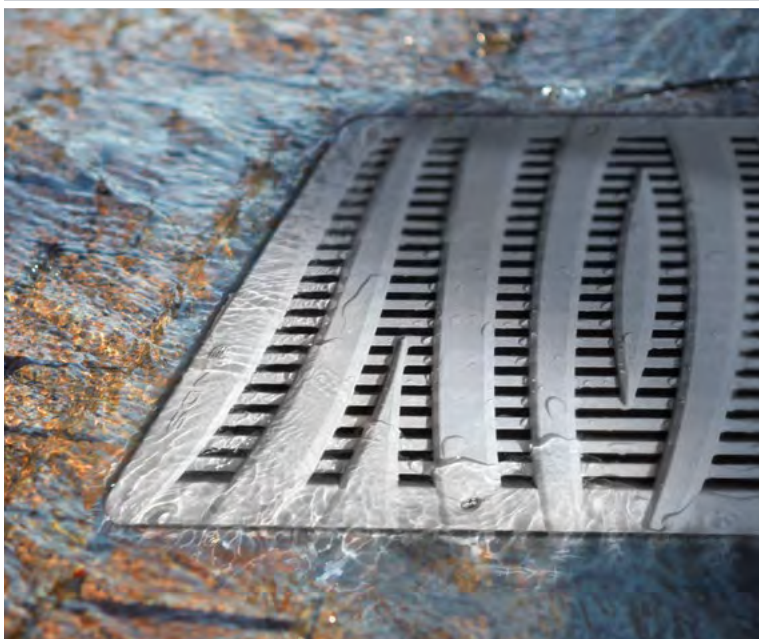





COMMERCIAL STORMWATER SOLUTIONS

NDS® offers comprehensive commercial stormwater solutions in line with Low Impact Development policies by managing stormwater as close to its source as possible through runoff reduction and quality enhancement at the site scale. Our solution is built around known and trusted components, providing solutions that offer 5 key benefits:

- Conservation of water resources to improve our well-being
- Management of stormwater at the source to reduce downstream impact
- Flexibility of system footprint allows for adaptive implementation
- Mitigation of pollution and erosion to protect water systems
- Replenishment of groundwater to help ensure future supply

A single-source solution, NDS is easy to specify, qualifies for LEED credits and offers up to 250% more detention volume than traditional gravel systems.

Design Your System

An effective onsite stormwater system can be designed in 5 easy steps:

- 1 Identify Sources** - Stormwater runoff may come from point sources like downspouts, as sheet flow from parking lots, irregularly through drainage ways in the landscape, or even as elevated groundwater.
- 2 Select Method of Capture** - Each runoff source has a practical method of capture for conveyance to the detention and infiltration area.
- 3 Determine Peak Flow and Detention Volume** - The quantity of runoff for a given rainfall event over a defined area is easily calculated when surface type and rainfall intensity are known by using the Rational Method formula $Q = CiA$. Applicable regulations generally provide guidance on the rainfall intensity to use for a given set of circumstances.
- 4 Size the System** - Detention and infiltration devices have measured holding capacities. Select the appropriate quantity and arrangement of devices to handle the predetermined runoff volume calculated above. Also consider the capacity of conveyance and overflow piping.
- 5 Determine Field Layout** - Site constraints including setbacks, landform, soil types, fixed objects and open space, among others, will inform the location and arrangement of system components. Each element of runoff capture, filtration, conveyance, detention, infiltration and overflow must be considered.

CAPTURE

Catch basins receive runoff from downspouts and landscaped areas. **Channel drains** accept sheet flows from paved walks and parking.

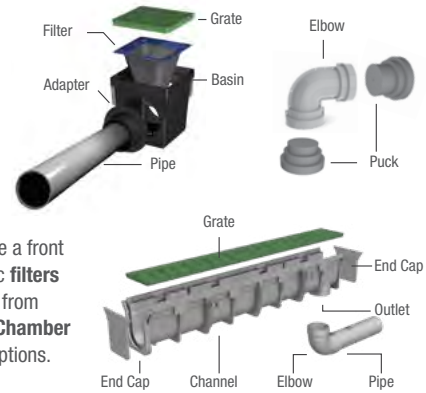

FILTRATION

Basins and channel grates provide a front line of debris filtration; adding fabric **filters** contributes further removal of fines from stormwater, extending system life. **Chamber systems** have advanced filtration options.

CONVEYANCE

Smooth-wall and corrugated pipe with compatible fittings and adapters convey stormwater from the point of capture to the detention and infiltration area. Select pipe type and set pipe slope to handle the anticipated runoff volumes based on established pipe-flow characteristics. Using EZflow for conveyance may reduce the footprint of downstream detention and infiltration areas.

DETENTION & INFILTRATION

Flo-Well® manufactured dry wells provide 50 gallons of detention volume. Each unit has multiple connection points including sidewall and top-cover knock outs to receive 3" to 8" pipe. Flo-Well's are stackable and can be arranged in multiple configurations.

EZflow® engineered French drains are 10' bundles of Poly-Rock aggregate with or without corrugated drain pipe. Bundles are available in 7", 10" and 15" diameters, with or without 3", 4" or 6" pipe, respectively. A standard infiltration trench consists of a 10" bundle with 4" pipe atop two 15" aggregate-only bundles, providing over 100 gallons of detention volume.

NDS® StormChamber® provides a lower cost alternative to drainage pipes for conveyance, with added benefits of groundwater recharge and water quality enhancement. Chambers eliminate the need for restrictive holding ponds and can be stacked in many applications to reduce footprint and save valuable land space.

OVERFLOW

Pop-up emitters allow excess runoff beyond system capacity to discharge in a safe location.

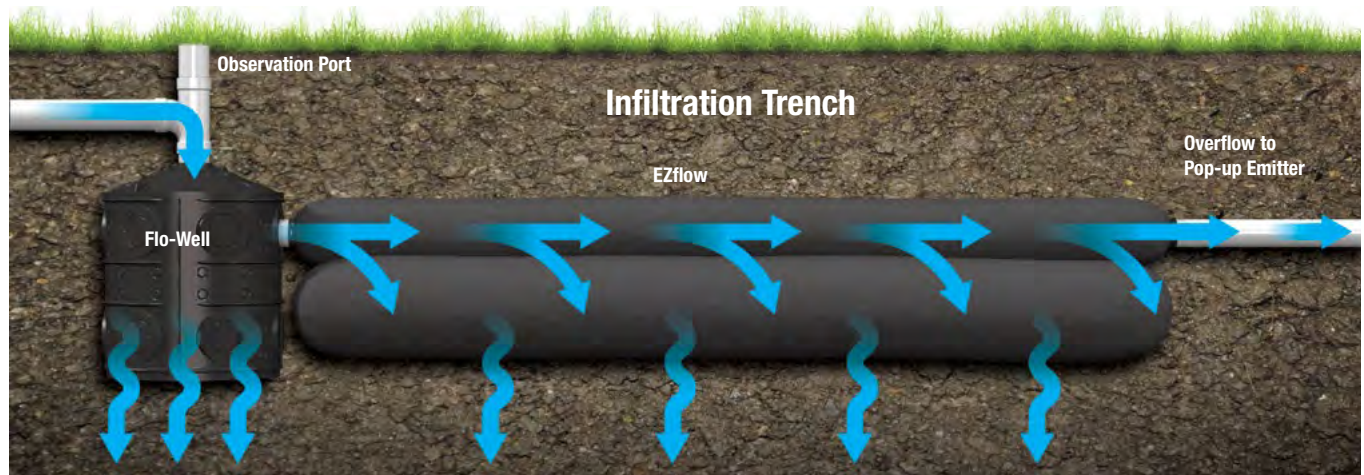

DRAINAGE

SUSTAINABLE STORMWATER SOLUTIONS

NDS components can be configured to meet a wide variety of residential and commercial applications.

CAPTURE

NDS offers several options to collect stormwater from various sources.

- Catch basins function effectively as area drains and for downspouts from roofs
- Channel drains intercept sheet flow from paved surfaces
- Permeable grass and gravel paver systems with underdrains collect stormwater from walkways and parking areas when used as alternatives to traditional impermeable solutions

FILTER

Prevent debris and other suspended solids in stormwater from impairing system function.

- Basin and channel grates provide a front line of mechanical filtration
- Fabric filters contribute further removal of fines from stormwater, extending system life
- Grass and gravel paver systems naturally filter and clean stormwater while flowing through the permeable paver solutions

CONVEY

Move stormwater from its sources to downstream detention, infiltration and overflow components.

- Smooth-wall and corrugated pipe with appropriate fittings and adapters have known flow characteristics to get the job done
- Using EZflow® for conveyance will also increase system detention and infiltration, effectively reducing the footprint of the downstream detention area

DETAIN

NDS detention components provide efficient volume to minimize runoff and maximize infiltration.

- Flo-Well® dry wells, NDS® StormChamber® and EZflow® infiltration-trench arrangements have defined volumes for this purpose.

INFILTRATE

Arrange Flo-Well® dry wells, NDS® StormChamber® and EZflow® infiltration trenches in customizable configurations and at depths suitable to existing site conditions, soil types and groundwater elevations.

- Flo-Well® has an open bottom and side knockouts to allow direct infiltration, and EZflow® maximizes soil-contact area for effective infiltration

OVERFLOW

Allow for excess stormwater beyond the design storm to overflow from the system in a safe, suitable downstream location.

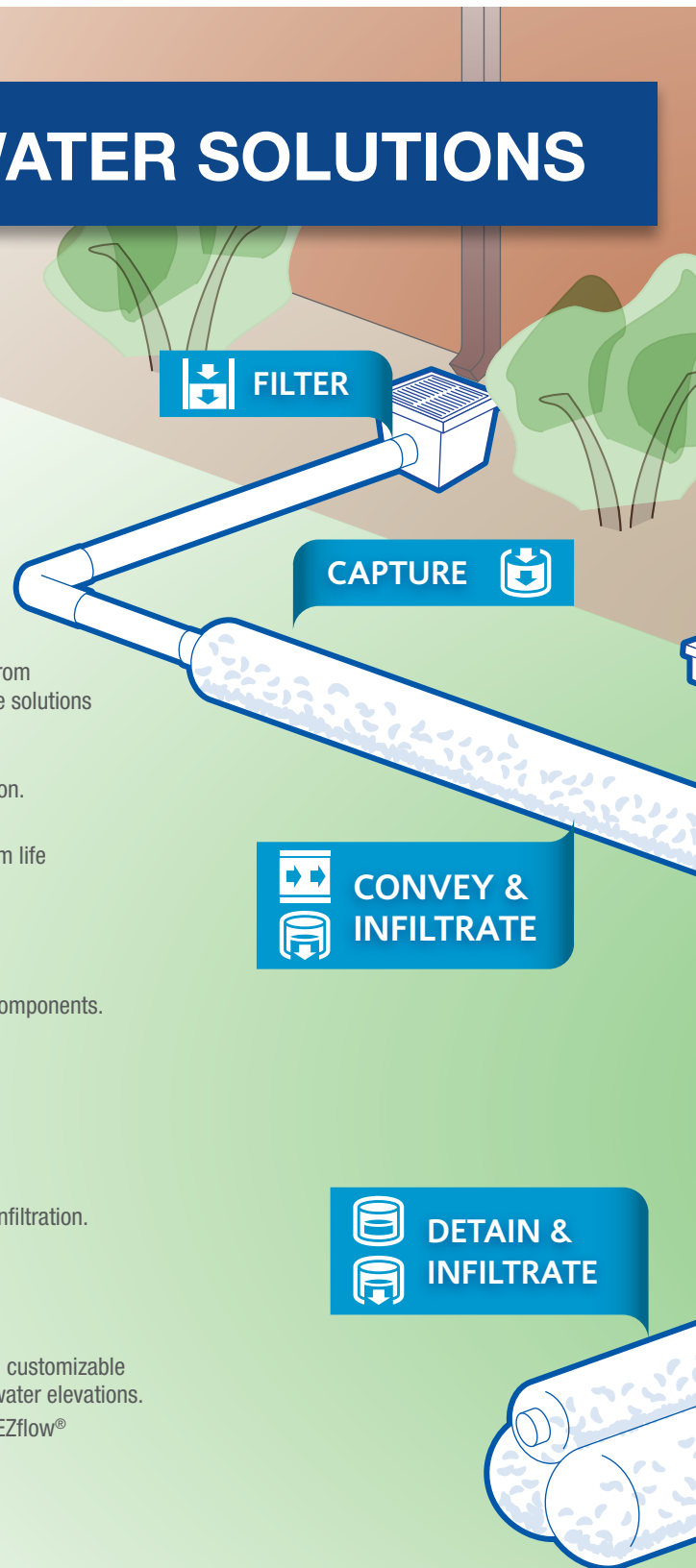

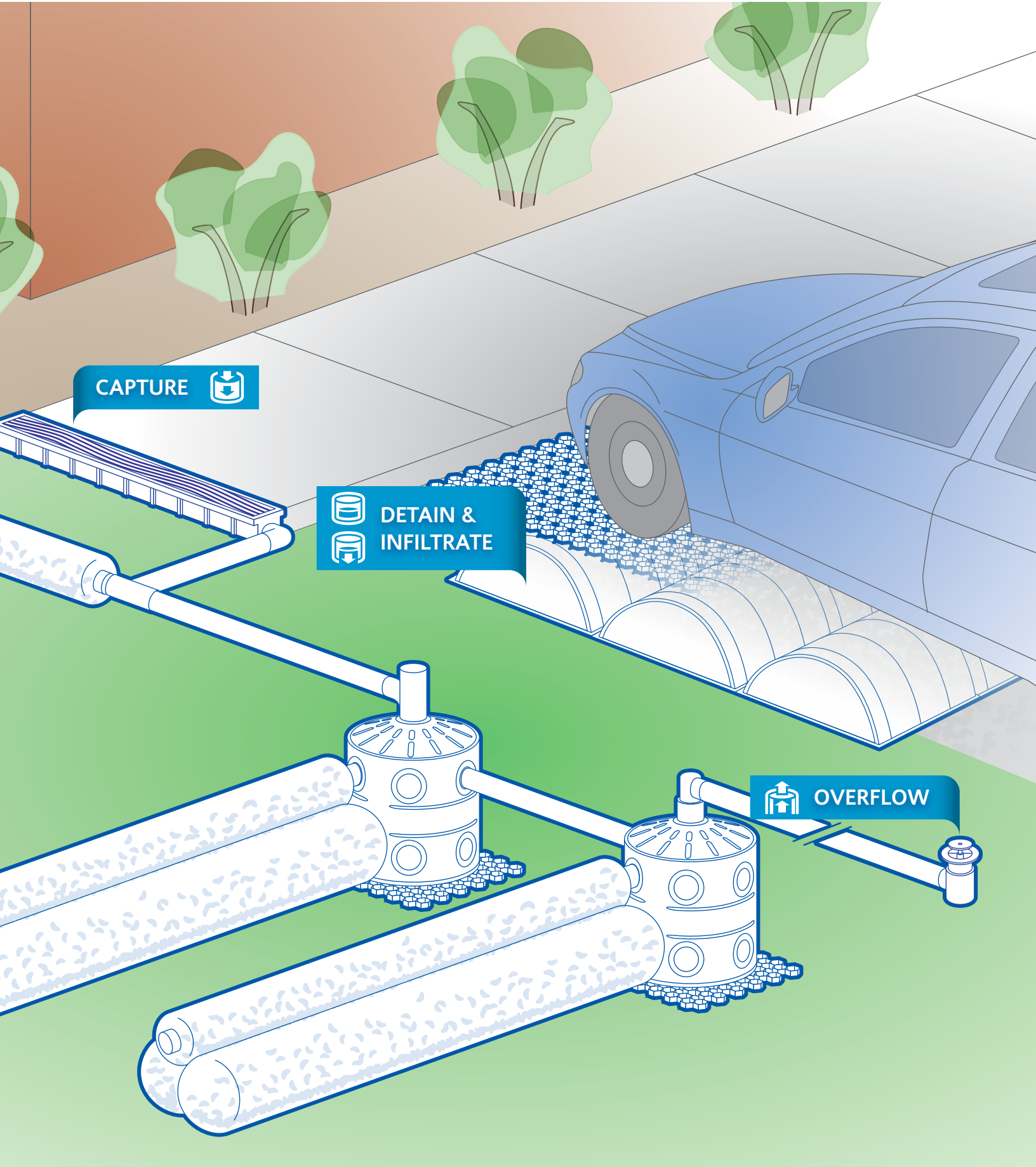



SUBSURFACE DRAINAGE & INFILTRATION



NDS®
StormChamber®

THE NDS SOLUTION

Whether you need a dry well, French drain or infiltration trench, NDS has you covered with innovative and proven subsurface drainage and stormwater infiltration products. EZflow® French drain system, NDS® StormChamber® and Flo-Well® dry well provide trusted performance for multiple applications and are lightweight and easy to install. These engineered solutions are proven time-and-labor savers that outperform traditional systems in flow through and storage capacity. When performance and sustainability matter, NDS solutions are the preferred choice of contractors, engineers and landscape architects. **EZflow®, NDS® StormChamber® and Flo-Well® are made in the USA and each contribute to project LEED credits when used as part of the stormwater management design and by contributing to the proportion of recycled materials.**



DRAINAGE

EZflow®

EZflow® offers an engineered and gravel-free alternative to a traditional French Drain system. EZflow® can be used to lower subsurface groundwater elevations; protecting property and improving the health of playing fields and planted areas. It can also be used as an infiltration trench for managing stormwater runoff. Available in multiple diameters with or without pipe, this versatile product is an effective component of subsurface drainage and infiltration systems.

- Installs in half the time of traditional gravel systems
- Better flow capacity than traditional stone-and-pipe systems
- Up to H-10 load rating with 12" of compacted soil cover
- Over 100 million linear feet installed

NDS® StormChamber®

Stormwater chambers provide a lower cost alternative to drainage pipes for conveyance, with added benefits of groundwater recharge and water quality enhancement. Stronger and easier to maintain, NDS® StormChamber® is the ideal solution for stormwater detention and/or infiltration, providing easy installation and design flexibility to meet target stormwater runoff rates, volume control and water quality requirements.

- Thermo-formed high density weight polyethylene HMWPE material won't crack
- 100-year life expectancy – Longest on the market
- Saves time and money – offers the lowest installed cost
- Proprietary SedimenTrap™ offers centralized sediment control, gathering sediment and pollutants in one place for quick removal by vacuum truck.

Flo-Well®

Flo-Well® engineered dry well presents an easy to install and sustainable solution for managing stormwater runoff. Flo-Well® is a gravel-free alternative to a traditional dry well with up to 250% more detention volume. Used independently or as part of a larger system, Flo-Well® units collect and detain stormwater allowing for groundwater recharge. Units are modular and can be connected in series or stacked to meet a variety of project needs.

- Up to 50 gallons of detention volume per unit
- Connect units in series for larger volumes or stack for reduced footprint
- Fast and easy installation with no heavy equipment or gravel needed
- Manufactured from 100% recycled materials

EZFLOW®: A BETTER FRENCH DRAIN



- Gravel-free installation provides up to 50% labor savings over traditional systems
- Better flow through and detention volume than traditional systems
- Durable with a 100-year materials lifespan when installed
- Projects qualify for LEED credits

EZflow® Drainage Bundles

EZflow® drainage bundles are 10 feet in length with a slotted pipe surrounded by expanded polystyrene aggregate and enclosed in geotextile mesh. Configurations are available in 7-inch bundles with or without a 3-inch pipe, 10-inch bundles with or without a 4-inch pipe, and 15-inch bundles with or without a 6-inch pipe. Accessories include 3-inch, 4-inch, and 6-inch internal couplers and end caps. EZflow® bundles can also be used with internal tees, and internal wyes. The 15-inch bundles are available with the pipe located in the center or bottom of the bundle for varying applications. Unless specifically required by code or other requirement, the pipe can be either centered or at the bottom of the bundle.

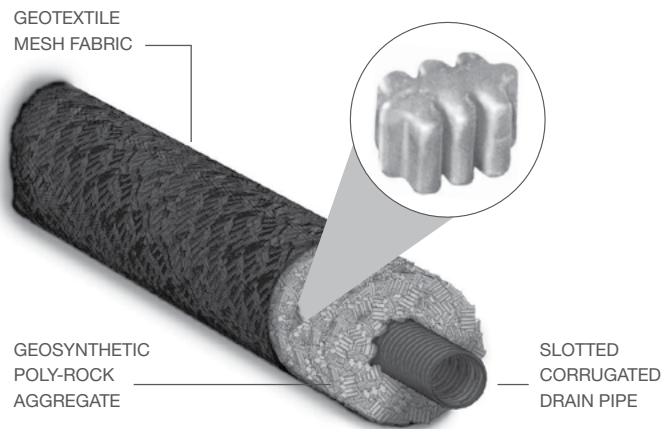

Applications

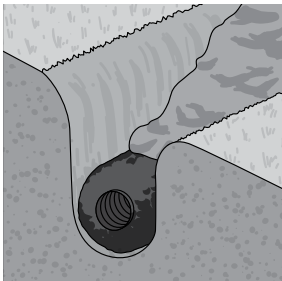

French/Interceptor Drains

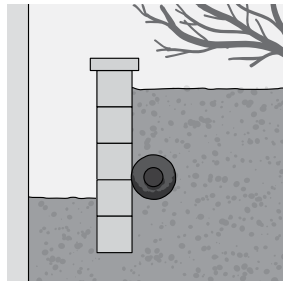

Planter/Retaining Walls

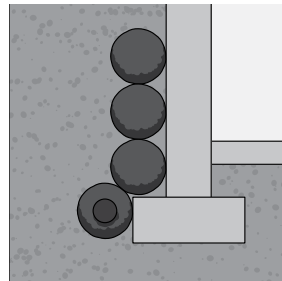

Foundation Drains

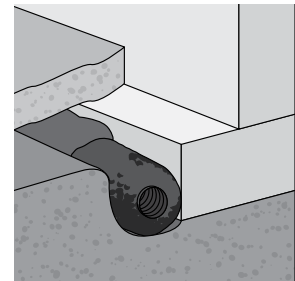

Basement/Crawlspace

EZflow® drainage systems are appropriate for a wide range of applications and are a convenient alternative to traditional stone and pipe drainage, storage and infiltration systems. EZflow® drainage systems can be used as a substitute for stone in most applications where the stone is not utilized for structural support. A professional engineer, landscape architect or other qualified design professional should be consulted for complex applications.

Product selection is relative to the desired application and benefits from establishing anticipated flow into, through and out of a proposed drainage system configuration. Selection considerations include: bundle sizing and storage volume, the presence or absence of pipe, pipe size and location within the bundle, and arrangement of bundles. Design factors may include: length of system, watershed area, soil type and permeability, groundwater levels and system discharge opportunities. EZflow® drainage storage volumes and pipe discharge rates are listed on the next page.

EZFLOW® ENGINEERED FRENCH DRAIN

EZflow® Gravel-Free French Drain

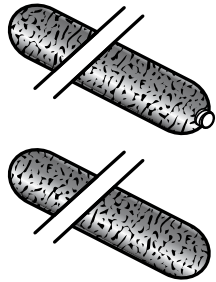

| Part No. | Description | Color | Bundle size/ Linear Feet | Wt. per Bundle (lbs.) | Product Class | Specifications |
|----------|--|-------|--------------------------|-----------------------|---------------|---|
| EZ-0701F | 7" mesh with 3" slotted pipe (center) | Black | 90 | 32.4 | 11RP | 10 ft. polyethylene slotted drain pipe surrounded by 100% recycled polystyrene aggregate and enclosed in 30-sieve polyethylene geotextile mesh. |
| EZ-1001F | 10" mesh with 4" slotted pipe (center) | Black | 50 | 29.5 | 11RP | |
| EZ-1501F | 15" mesh with 6" slotted pipe (center) | Black | 20 | 26.0 | 11RP | |
| EZ-0701A | 7" mesh without pipe – aggregate only | Black | 90 | 18.0 | 11RP | 10 ft. segment of 100% recycled polystyrene aggregate only, enclosed in 30-sieve polyethylene geotextile mesh. |
| EZ-1001A | 10" mesh without pipe – aggregate only | Black | 50 | 13.5 | 11RP | |
| EZ-1501A | 15" mesh without pipe – aggregate only | Black | 20 | 12.4 | 11RP | |

DRAINAGE

EZflow® Internal Couplings & End Caps



| Part No. | Description | Color | Pkg. Qty. | Wt. Ea. (lbs.) | Product Class |
|----------|---------------------------------|-------|-----------|----------------|---------------|
| 3C05 | 3" Corrugated Internal Coupling | Black | 60/box | 0.30 | 11RP |
| 4C07 | 4" Corrugated Internal Coupling | Black | 36/box | 0.30 | 11RP |
| 6C07 | 6" Corrugated Internal Coupling | Black | 12/box | 0.80 | 11RP |
| 3C06 | 3" Corrugated End Cap | Black | 33/box | 0.30 | 11RP |
| 4C06 | 4" Corrugated End Cap | Black | 21/box | 0.50 | 11RP |
| 6C06 | 6" Corrugated End Cap | Black | 15/box | 0.50 | 11RP |

Storage & Flow for EZflow® Drainage Bundles *(45% void space among consolidated EPS aggregate)*

| Pipe Bundles | | |
|--------------|--|--------------------------------|
| Product | Storage Volume (gallons/10 ft. bundle) | Flow Capacity (gpm @ 1% slope) |
| EZ-0701F | 11.4 | 80.8 |
| EZ-1001F | 21.5 | 130.9 |
| EZ-1501F | 45.8 | 345.0 |

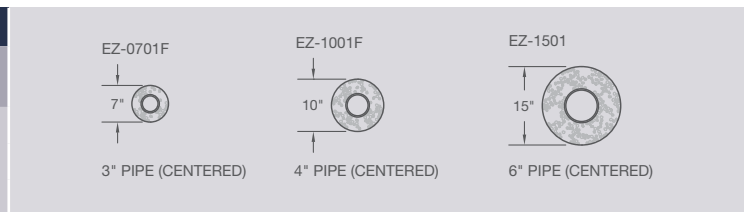

| Aggregate-Only Bundles | | |
|------------------------|--|--------------------------------|
| Product | Storage Volume (gallons/10 ft. bundle) | Flow Capacity (gpm @ 1% slope) |
| EZ-0701A | 8.8 | 37.1 |
| EZ-1001A | 17.2 | 75.7 |
| EZ-1501A | 36.5 | 170.3 |

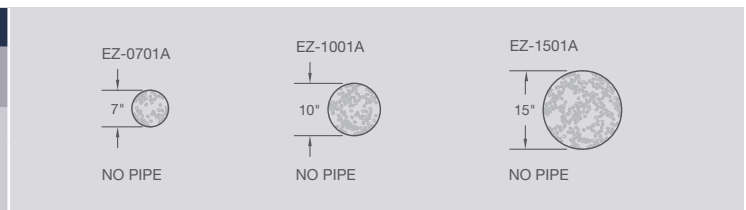

NDS® STORMCHAMBER®: THE MOST COST-EFFECTIVE CHAMBER SOLUTION

DRAINAGE



NDS® StormChambers® are subsurface structures that are used to collect, retain and discharge stormwater on commercial and residential sites. They provide a lower cost alternative to drainage pipes for conveyance, with the added benefits of groundwater recharge and water quality enhancement.

Stronger & Easier to Maintain – High Volume Stormwater Retention

NDS® StormChamber® is the most cost-effective chamber solution on the market. Thermo-formed from high density weight polyethylene HMWPE material, it offers superior strength that won't crack even under the most extreme environments. Designed for fast installation and simple maintenance, NDS® StormChamber® is ideal for roadways, parking lots and fields and can stack, allowing for deeper installation and a smaller footprint.

Key Benefits:



Strong, Flexible & Durable

- Meets H-20 standards
- Up to 16' cover when deep installs are required for the 34". Up to 12' for the 44"
- 100-Year Life Expectancy
- Withstands the most extreme environments
- Material bends instead of breaks, giving it a brittleness temperature of -107° F vs. industry average of -2° F

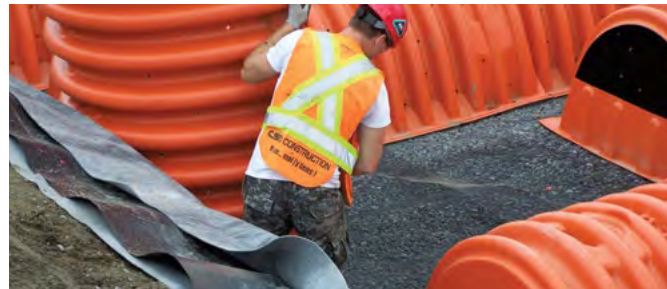

Fast Installation

- Built-in end walls
- No header pipe manifold system required
- Flexible design
- Lowest installed cost

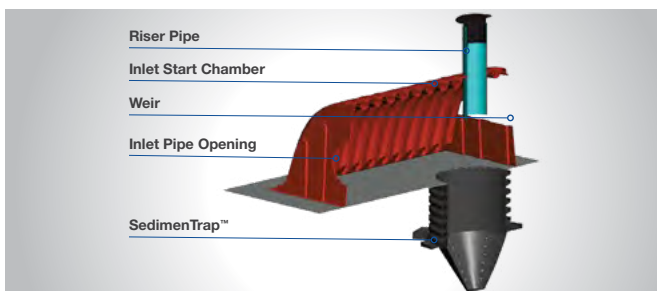

Simple Maintenance

- Differentiated and centralized sediment control
- SedimenTrap™ gathers sediments and other pollutants in one place for quick, easy and inexpensive removal by vacuum truck

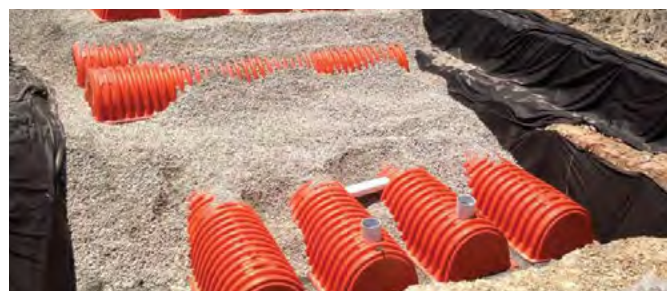

Stacks

- 34" Chambers: Capable of 3-layer stacking
- 44" Chambers: Contact NDS DesignWorx for any projects that may need stacking
- We offer expert site-specific design guidance based on 20 years of successful completion of projects

NDS® STORMCHAMBER®

NDS® StormChamber®



| Part No. | Description | Color | Length | Width | Height | Weight (lbs.) | Per Pallet | Product Class |
|--------------|-----------------------------------|--------|--------|-------|---------------|---------------|------------|---------------|
| SC-3475W-S-0 | 75CUFT START CHAMBER100X60X34 | Orange | 100" | 60" | 34" | 90 | 40 | 10SC |
| SC-3475W-E-0 | 75CUFT END CHAMBER100X60X34 | Orange | 100" | 60" | 34" | 90 | 40 | 10SC |
| SC-3475W-M-0 | 75CUFT MIDDLE CHAMBER100X60X34 | Orange | 100" | 60" | 34" | 90 | 40 | 10SC |
| SC-3475W-C-0 | 75CUFT CLOSED CHAMBER100X60X34 | Orange | 100" | 60" | 34" | 90 | 40 | 10SC |
| SC-3475-S-0 | 75CUFT START CHAMBER102X60X34 | Orange | 102" | 60" | 34" | 100 | 30 | 10SC |
| SC-3475-E-0 | 75CUFT END CHAMBER102X60X34 | Orange | 102" | 60" | 34" | 100 | 30 | 10SC |
| SC-3475-M-0 | 75CUFT MIDDLE CHAMBER102X60X34 | Orange | 102" | 60" | 34" | 100 | 30 | 10SC |
| SC-3475-C-0 | 75CUFT CLOSE CHAMBER102X60X34 | Orange | 102" | 60" | 34" | 100 | 30 | 10SC |
| SC-44105-S-0 | 105CUFT START CHAMBER90X78X44 | Orange | 90" | 78" | 44" | 120 | 20 | 10SC |
| SC-44105-E-0 | 105CUFT END CHAMBER90X78X44 | Orange | 90" | 78" | 44" | 120 | 20 | 10SC |
| SC-44105-M-0 | 105CUFT MID CHAMBER90X78X44 | Orange | 90" | 78" | 44" | 120 | 20 | 10SC |
| SC-44105-C-0 | 105CUFT CLOSE CHAMBER90X78X44 | Orange | 90" | 78" | 44" | 120 | 20 | 10SC |
| SC-1820-S-0 | 20CUFT START CHAMBER 18" | Orange | 100" | 37" | 18" | 53 | 45 | 10SC |
| SC-1820-E-0 | 20CUFT END CHAMBER 18" | Orange | 100" | 37" | 18" | 53 | 45 | 10SC |
| SC-1820-M-0 | 20CUFT MIDDLE CHAMBER 18" | Orange | 100" | 37" | 18" | 53 | 45 | 10SC |
| SC-1820-C-0 | 20CUFT CLOSED CHAMBER 18" | Orange | 100" | 37" | 18" | 53 | 45 | 10SC |
| SC-ST | SEDIMENT TRAP | Orange | 47" OD | - | 2' | 3 | 4 | 10SC |
| SC-2412P | 24" x 12" HDPE Pipe | Orange | 24" | - | 12" | 9.25 | 20 | 10SC |
| SC-NWFF-500 | FILTER FABRIC NON-WOVEN LIGHT | Orange | 360' | 12.5' | 1.5' OD roll | 220 | 3 | 10SC |
| SC-WFF-75 | STABILIZATION FABRIC WOVEN MEDIUM | Orange | 75' | 7.5' | 0.75' OD roll | 75 | 16 | 10SC |
| SC-FL-10 | 10" FRAME AND LID | Orange | 20" OD | - | 3" | 24 | - | 10SC |
| SC-3020P | 30" X 20" HDPE PIPE | Orange | 36" OD | - | 20" | 45 | 4 | 10SC |

DRAINAGE

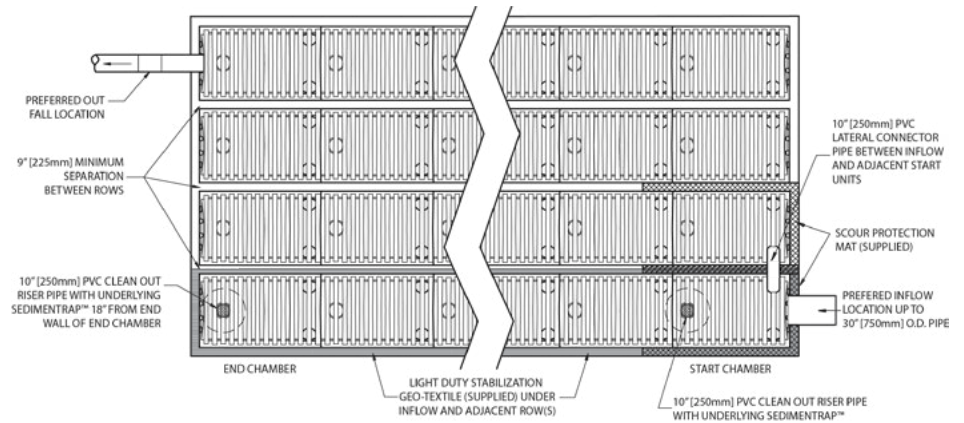

NDS® StormChamber® Elevated View

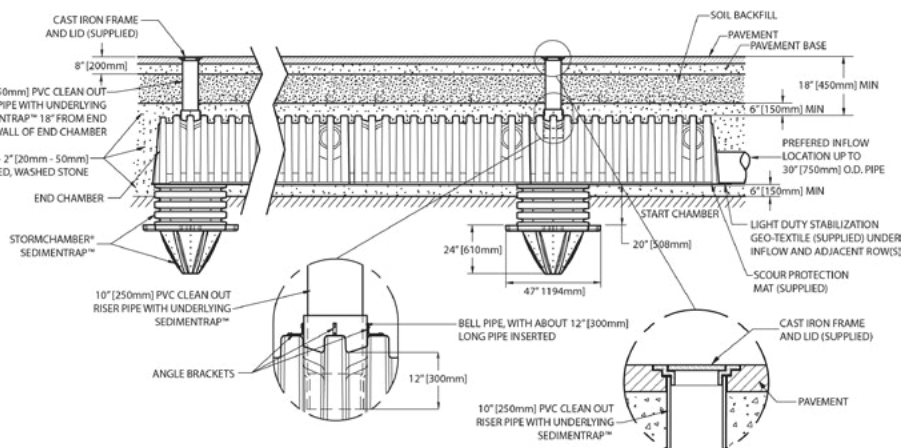

FLO-WELL®: A BETTER DRY WELL

DRAINAGE



With the Flo-Well®, water can now be infiltrated into the subsoil rapidly and easily. Unlike competitive systems, there is no need for piping systems to transport stormwater to a far-off discharge point, large heavy equipment, considerable excavation of current landscaped areas, nor large labor costs that those systems incur. With Flo-Well, water infiltration is now easier than ever.

Options

| Larger 9" or 12" grates can be added to Flo-Well to manage surface water. | Ideal as a stand-alone drain: | Ideal as a stand-alone reservoir: |
|---|---|---|
| This option is ideal for draining: | Disturbs only 4 square feet of turf to install | Collect and hold rainwater for lawn and garden irrigation (used with a pump connected to a garden hose) |
| Golf course areas prone to puddling | Requires less than 10 cubic feet of soil removed to bury | Connect Flo-Well to rain gutters using a catch basin & grate below each downspout (see drawing) |
| Playground areas under slides and swings | Measures only 24" in diameter by 28.75" high | Ideal solution for arid areas impacted by drought |
| Outdoor drinking fountain runoff | Weighs only 22 pounds | Reservoir for pond and waterfall recirculation pumps |
| Outdoor showers at beaches | Holds over 48 gallons. Or, connect to existing system for increased drainage capabilities | |
| Wash-down areas | | |



Stackable & Expandable

Flo-Well® can be used individually, connected in series or in any array, and can be stacked up to 4 units high (with center support pipe).

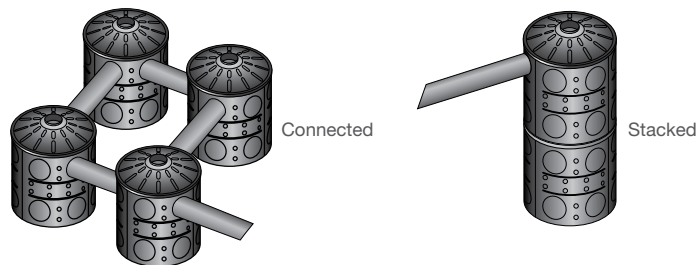

Applications

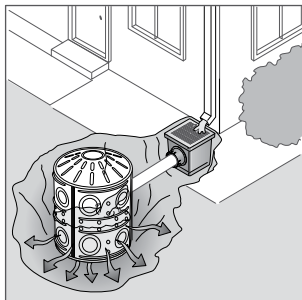

For gutters and downspouts

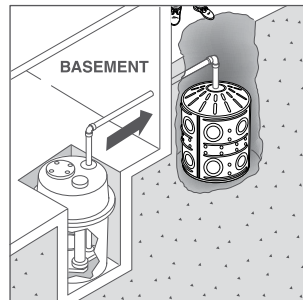

Install with sump pumps

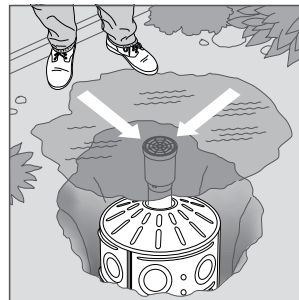

Eliminates puddles

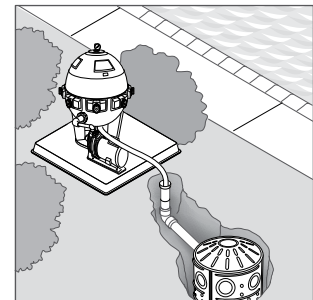

Backwash tank

FLO-WELL® ENGINEERED DRY WELL

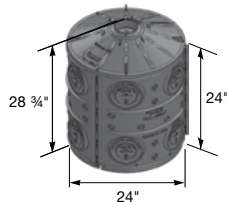

| Part No. | Description | Color | Pkg. Qty. | Wt. Ea. (lbs.) | Product Class | Specifications |
|--|--|-------|-----------|----------------|---------------|---|
| FWAS24WH | 24" diam. x 28.75"H Flo-Well® Stormwater Leaching System | Black | 1 | 18.96 | 10FW | NDS #FWAS24WH structural foam polyolefin round drywell system with UV inhibitors. 50 gal. storage capacity. |
| Includes 3 side panels, 1 top component. Fits 4" Sch. 40 Pipe and 4" DWV Pipe. | | | | | | |

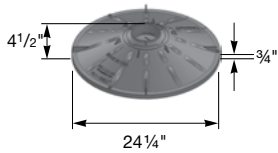

| Part No. | Description | Color | Pkg. Qty. | Wt. Ea. (lbs.) | Product Class | Specifications |
|-------------------|---------------------------|-------|-----------|----------------|---------------|---|
| FWAS24CWH | 24" diam. Flo-Well® Cover | Black | 2 | 5.92 | 10FW | Structural foam polyolefin round drywell system cover with UV inhibitors. 24-1/4" dia., 4-1/2" height, 3/4" outer lip, 4.5" center knockout fits NDS #FWSD69, std pipe and 4" Sch. 40 pipe. |
| Use with #FWAS24. | | | | | | |

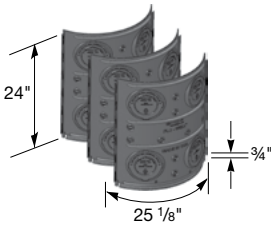

| Part No. | Description | Color | Pkg. Qty. | Wt. Ea. (lbs.) | Product Class | Specifications |
|--|--------------------------------------|-------|-----------|----------------|---------------|---|
| FWSPS3WH | Flo-Well® Side Panels/Extension Only | Black | 1 | 4.35 | 10FW | Structural foam polyolefin side panels with UV inhibitors with 22 1-1/2" knockout leaching ports and 4 4.5" knockout inlet/outlet ports per panel. 0.75" lip for firm stacking. |
| Includes 3 side panels; makes 1 round drywell. (May also be used as a durable compost bin) | | | | | | |

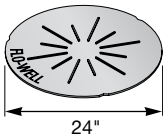

| Part No. | Description | Color | Pkg. Qty. | Wt. Ea. (lbs.) | Product Class | Specifications |
|--|----------------------------|-------|-----------|----------------|---------------|---|
| FWBP24 | 24" diam. Flo-Well® Bottom | Black | 5 | 3.41 | 10FW | Structural foam polyolefin round Flo-Well® bottom with UV inhibitors. 24" diameter with six 1-1/2" leaching ports. Collects debris for easy cleanout. |
| Fits #FWAS24. (Not included in #FWAS24 kit) | | | | | | |

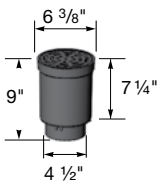

| Part No. | Description | Color | Pkg. Qty. | Wt. Ea. (lbs.) | Product Class | Specifications |
|--|---|-------|-----------|----------------|---------------|--|
| FWSD69 | 4" Sch. 40 Surface Drain Inlet with Grate | Black | 8 | 1.85 | 10FW | Structural foam polyolefin 6" grate with 4" inlet with UV inhibitors. 6" diameter at inlet. 9" high. 4.5" OD fits Sch. 40 PVC fittings. Open surface area 8.22 square inches. 25.15 GPM. |
| Fits #FWAS24 and #FWAS24C. ADA Compliant. | | | | | | |

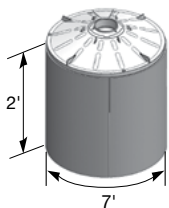

| Part No. | Description | Color | Pkg. Qty. | Wt. Ea. (lbs.) | Product Class | Specifications |
|-------------------|---|-------|-----------|----------------|---------------|--|
| FWFF67 | Porous Filter Fabric Wrap for Flo-Well® | Black | 1 | 0.35 | 10FW | 7' long x 2' wide to surround Flo-Well® Drywell System. Non-woven fabric. Weight 1 oz. Mullen burst 175 psi. 200 GPM flow-through. |
| Use with #FWAS24. | | | | | | |

CATCH BASINS



NDS catch basins and grates collect surface water while minimizing the amount of debris entering the system

Available in a range of sizes from 6" round to 24" square, and with various grating and filter options for commercial and residential systems.

DRAINAGE

NDS Drainage Solutions

NDS offers a complete line of catch basins and grates for residential and commercial stormwater management solutions. NDS catch basins have sump areas that collect debris and prevent clogging of the pipeline, and grates are available in a variety of patterns and colors to blend in with surrounding surfaces. Depending on the size of the round, square, or atrium grates, they may fit directly into a riser of pipe, sewer and drain fitting, or our catch basins.

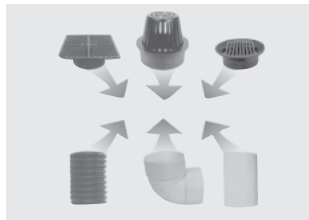

Small Grates

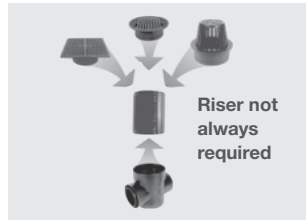

Spee-D® Basin

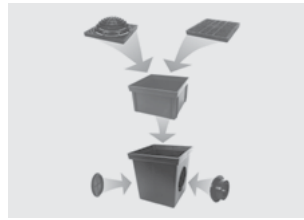

Large Catch Basin

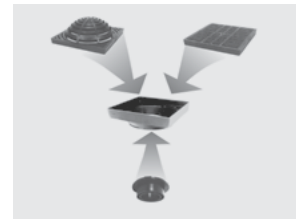

Adapter

Spee-D® Basins

Use our compact 6" round Spee-D Basins with grates to collect runoff water while its sump area collects debris and prevents clogging. Also use Spee-D Basins with 6" Pop-Up Emitters to provide a point of discharge or overflow in a drainage system.

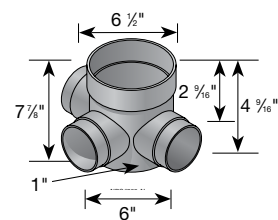
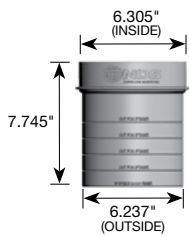
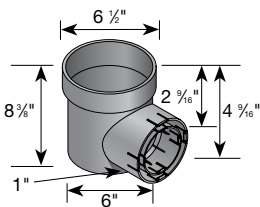

| Part No. | Description | Color | Pkg. Qty. | Wt. Ea. (lbs.) | Product Class | Specifications |
|--|--|-------------|-----------|----------------|---------------|---|
| 101 | 1 - 3" and 4" Locking Outlet | Black | 10 | 1.60 | 10ND | 6" styrene catch basin with locking outlet. 68 GPM per outlet capacity. |
| 101ATBLKIT | Spee-D Basin with 6" Black Atrium Grate | Black Grate | 8 | n/a | 10ND | |
| 101GRKIT | Spee-D Basin with 6" Green Round Grate | Green Grate | 6 | n/a | 10ND | |
| 101SQGRKIT | Spee-D Basin with 9" x 9" Green Square Grate | Green Grate | 8 | n/a | 10ND | |
| 201 | 3" and 4" Locking Outlets* | Black | 10 | 1.83 | 10ND | Kits contain 1-outlet Spee-D Basin & Grate as described. |
| Spee-D Basins and kits fit 3" or 4" Sewer & Drain Pipe, 3" or 4" Corrugated Pipe, 4" Sch. 40 and 3" & 4" Triple Wall Pipe. Use new Spee-D Riser or 6" Sewer and Drain Pipe as a riser for all 6" round catch basins. Use waterproof silicone to make water-tight connections. Locking Outlet snaps on to most 3" and 4" corrugated pipe. | | | | | | |

| Part No. | Description | Color | Pkg. Qty. | Wt. Ea. (lbs.) | Product Class | Specifications |
|---|--------------------|-------|-----------|----------------|---------------|-------------------------------------|
| 101R | Spee-D Basin Riser | Black | 12 | 1.07 | 10ND | 6" Riser for Spee-D Basin. Styrene. |
| Use with any Spee-D Basin to add from 2" to 6" to top of basin. Can be cut to size and has guidelines in 1" increments. Compatible with all grates that fit Spee-D Basin. | | | | | | |

| Part No. | Description | Color | Pkg. Qty. | Wt. Ea. (lbs.) | Product Class | Specifications |
|---|--------------------|-------|-----------|----------------|---------------|---|
| 250 | 2 - 4" 90° Outlets | Black | 12 | 1.64 | 10ND | 6" styrene catch basin with pipe outlets. 83 GPM per outlet capacity. |
| 300 | 3 - 4" Outlets | Black | 12 | 1.82 | 10ND | |
| 350 | 4 - 4" Outlets | Black | 12 | 2.00 | 10ND | |
| Fit 4" Sewer & Drain pipe and fittings, 4" SCH40 and Corrugated Pipes. Use Spee-D Basin Riser 101R or 6" Sewer & Drain pipe as riser extension. | | | | | | |

CATCH BASINS

9" Catch Basin Series

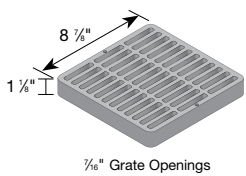
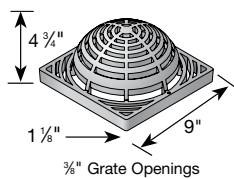
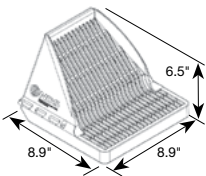
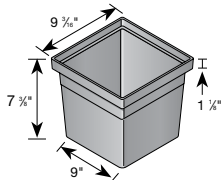
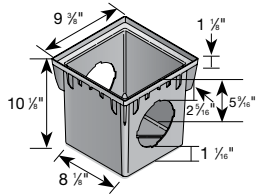

| Part No. | Description | Color | Pkg. Qty. | Wt. Ea. (lbs.) | Product Class | Specifications |
|--|-----------------------|--------------------------|-----------|----------------|---------------|---|
| 900FF | 9" Catch Basin Filter | Blue Frame/ Black Bag | 8 | 0.06 | 10ND | Polypropylene Frame Fabric is non-woven geotextile 956 PM/SF. |
| Compatible with these basins: 900, 900-4 and 916 NDS Catch Basins, Risers and Kits | | | | | | |

| Part No. | Description | Color | Pkg. Qty. | Wt. Ea. (lbs.) | Product Class | Specifications |
|--|---|----------------|-----------|----------------|---------------|--|
| 900BLKIT | 9" x 9" Catch Basin Kit | Black Grate | 4 | 4.90 | 10ND | 9" x 9" tapered Catch Basin. Polypropylene. |
| 900GRKIT | 9" x 9" Catch Basin Kit | Green Grate | 4 | 4.90 | 10ND | |
| 900KITDISP | 9" x 9" Catch Basin Kits in Display Box | Blk/Grn Grates | 8 | 39.2 | 10ND | Kits include 2-opening Catch Basin, Grate, Screws, 2 Outlets and 1 Plug. |
| 900 | 9" x 9" Catch Basin 2-opening | Black | 4 | 2.18 | 10ND | |
| 900-4 | 9" x 9" Catch Basin 4-opening | Black | 4 | 2.00 | 10ND | |
| DISP includes 4 kits with black grates and 4 green | | | | | | |
| Requires either #1206, #1242, #1243, #1245 or #1266 Universal Outlet to connect pipe to basin. (see page 35) | | | | | | |

| Part No. | Description | Color | Pkg. Qty. | Wt. Ea. (lbs.) | Product Class | Specifications |
|--|---------------------------|-------|-----------|----------------|---------------|--|
| 916 | 9" x 9" Catch Basin Riser | Black | 4 | 1.75 | 10ND | 6" Riser for 9" x 9" Catch Basin. Styrene. |
| Use with 9" x 9" Catch Basin Series. Stacks on top of 9" catch basins to add up to 6" to top of basin. Can be cut to size. | | | | | | |

| Part No. | Description | Color | Pkg. Qty. | Wt. Ea. (lbs.) | Product Class | Specifications |
|--|-----------------------------------|-------|-----------|----------------|---------------|---|
| 900DSG | 9" x 9" Downspout Defender Grate | Black | 4 | 0.8 | 10ND | 9" x 9" Downspout Grate, Structural Foam Polyolefin with UV inhibitors. 146 GPM. |
| Receives downspouts from 2" to 4" round or square. Fits all NDS 9" square Catch Basins, Risers and Low-Profile Adapters | | | | | | |
| 900DSGKIT | 9" x 9" Low-Profile Downspout Kit | Black | 4 | 2.25 | 10ND | Kit includes 9" Downspout Defender Grate, 930 low-profile adapter and 1243 outlet adapter. 146 GPM. |
| Receives downspouts from 2" to 4" round or square. Fits 3" & 4" Corrugated Pipe, 3" & 4" Sewer and Drain Pipe, 4" Sewer and Drain Fittings, 4" Schedule 40 Pipe, and 3" & 4" Triple Wall Pipe. | | | | | | |

| Part No. | Description | Color | Pkg. Qty. | Wt. Ea. (lbs.) | Product Class | Specifications |
|--------------------------------------|----------------------|-------|-----------|----------------|---------------|--|
| 981 | 9" x 9" Atrium Grate | Black | 6 | 0.87 | 10ND | 9" Structural Foam Polyolefin Dome Atrium Grate with UV inhibitor. |
| 991 | 9" x 9" Atrium Grate | Black | 6 | 0.87 | 10ND | Open surface area 31.50 square inches. 96.36 GPM. |
| Use with 9" x 9" Catch Basin Series. | | | | | | |

| Part No. | Description | Color | Pkg. Qty. | Wt. Ea. (lbs.) | Product Class | Specifications |
|---|-----------------|-------|-----------|----------------|---------------|--|
| 980 | 9" Square Grate | Black | 8 | 1.50 | 10ND | 9" Square Structural Foam Polyolefin Grate with UV inhibitor. Open surface area 37.49 square inches. 114.69 GPM. |
| 990 | 9" Square Grate | Green | 8 | 1.50 | 10ND | |
| 999 | 9" Square Grate | Gray | 8 | 1.50 | 10ND | |
| 999S | 9" Square Grate | Sand | 8 | 1.50 | 10ND | |
| Use with 9" x 9" Catch Basin Series. NDS #980, 990, 999, 999S: Class A Load Rated. ADA Compliant. NDS #930B: Class B Load Rated. (see page 79). ADA Compliant. | | | | | | |

DRAINAGE

CATCH BASINS

9" Catch Basin Series (continued)

DRAINAGE

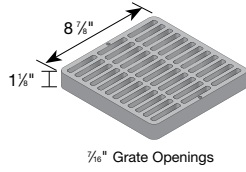

| Part No. | Description | Color | Pkg. Qty. | Wt. Ea. lbs. | Product Class | Specifications |
|---|-------------------------------|-------|-----------|--------------|---------------|--|
| 930B | 9" Square Brass Grate | Brass | 1 | 5.11 | 15BR | Open surface area 34.00 square inches. 104.01 GPM. Includes SS Screws. |
|  | (see page 79), ADA Compliant. | | | | | |

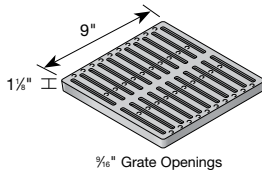

| Part No. | Description | Color | Pkg. Qty. | Wt. Ea. (lbs.) | Product Class | Specifications |
|---|---|--------|-----------|----------------|---------------|--|
| 913 | 9" Square Ductile Iron Grate | Black* | 4 | 7.89 | 10ND | 9" Square Heavy-Duty Ductile Iron Grate. Open surface area 21.70 square inches. 66.38 GPM. |
|  | Use with 9" x 9" Catch Basin Series. *Painted for shipping & display only; grate will form iron-oxide patina (see page 79) | | | | | |

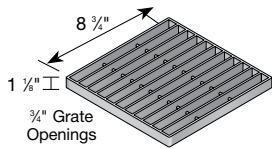

| Part No. | Description | Color | Pkg. Qty. | Wt. Ea. (lbs.) | Product Class | Specifications |
|---|---|------------------|-----------|----------------|---------------|---|
| 915 | 9" Square Galvanized Steel Grate | Galvanized Steel | 4 | 3.80 | 10ND | 9" Square Heavy-Duty Galvanized Steel Bar Grate. Open surface area 61.94 square inches. 189.48 GPM. |
|  | Use with 9" x 9" Catch Basin Series. (see page 79) | | | | | |

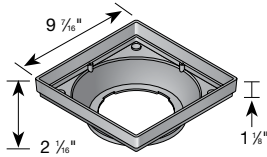

| Part No. | Description | Color | Pkg. Qty. | Wt. Ea. (lbs.) | Product Class | Specifications |
|---|--|-------------|-----------|----------------|---------------|--|
| 930 | 9" x 9" Low-Profile Adapter | Black | 8 | 0.75 | 10ND | 9" x 9" Low-Profile Adapter. Styrene. |
| 930GRKIT | 9" x 9" Low-Profile Adapter with Flat Green Grate and 3" & 4" Universal Locking Outlet | Green Grate | 8 | n/a | 10ND | Kits contain Low-Profile Adapter, 3" & 4" Universal Locking Outlet and Grate as described. |
| Adapter alone requires #1242, #1243, #1245, #1266 or #1889 Universal Outlets to connect to 3", 4", 6" or 8" Sewer and Drain or Corrugated Pipes (see page 35). Kits contain #1243 outlet. | | | | | | |

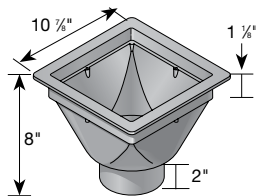

| Part No. | Description | Color | Pkg. Qty. | Wt. Ea. (lbs.) | Product Class | Specifications |
|---|-------------------------------------|-------|-----------|----------------|---------------|--|
| 931 | 9" x 9" Deep Housing Spigot Adapter | Black | 10 | 2.40 | 10ND | 9" x 9" Square Deep Housing Spigot Adapter. Styrene. |
| Fits 4" Corrugated Pipe. Use #933 to adapt to 4" Sewer and Drain Pipe. | | | | | | |

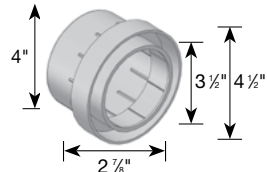

| Part No. | Description | Color | Pkg. Qty. | Wt. Ea. (lbs.) | Product Class | Specifications |
|--|-----------------|-------|-----------|----------------|---------------|----------------|
| 933 | Adapter Bushing | Black | 20 | 0.30 | 10ND | Styrene. |
| Bushing adapts #931 to fit 3" and 4" Sewer and Drain Pipes and 3" Corrugated Pipe. | | | | | | |

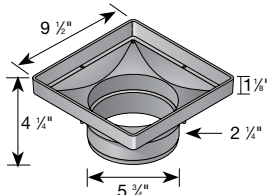

| Part No. | Description | Color | Pkg. Qty. | Wt. Ea. (lbs.) | Product Class | Specifications |
|---|-------------------------------------|-------|-----------|----------------|---------------|---|
| 932 | 9" x 9" Low-Profile Housing Adapter | Black | 8 | 1.13 | 10ND | NDS #932, 9" x 9" Square Low-Profile Housing Adapter with 6" Outlet. Styrene. |
| Fits 6" Spee-D® Basin and 6" Sewer and Drain Pipe & Fittings. | | | | | | |

CATCH BASINS

12" Catch Basin Series



| Part No. | Description | Color | Pkg. Qty. | Wt. Ea. (lbs.) | Product Class | Specifications |
|--|------------------------|--------------------------|-----------|----------------|---------------|---|
| 1200FF | 12" Catch Basin Filter | Blue Frame/ Black Bag | 8 | 0.10 | 10ND | Polypropylene Frame Fabric is non-woven geotextile 956 PM/SF. |
| Compatible with all NDS 12"x12" grates except plastic botanical 1218, 1218GR, 1218GY, 1218S. | | | | | | |

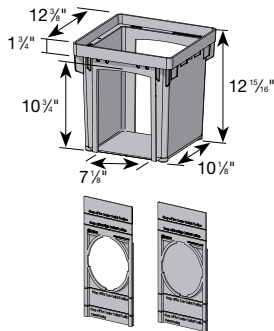

| Part No. | Description | Color | Pkg. Qty. | Wt. Ea. (lbs.) | Product Class | Specifications |
|--|--------------------------------------|-------|-----------|----------------|---------------|--|
| 1200NGBKIT | 12" x 12" Catch Basin, 2 Open Slides | Black | 4 | 4.65 | 10ND | Adjustable Outlet Catch Basin. Sides adjust to 3 different outlet elevations. Polypropylene basin and styrene sides. |
| 1200NGB | 12" x 12" Catch Basin | Black | 4 | 3.45 | 10ND | |
| 1207 | Open Slide for 1200NGB | Black | 8 | 0.60 | 10ND | |
| 1208 | Plug Slide for 1200NGB | Black | 8 | 0.76 | 10ND | |
| Compatible with 12" x 12" Catch Basin Risers and Grates. | | | | | | |

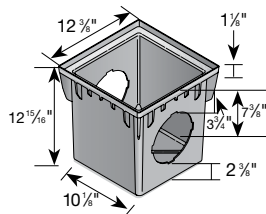

| Part No. | Description | Color | Pkg. Qty. | Wt. Ea. (lbs.) | Product Class | Specifications |
|---|---|----------------|-----------|----------------|---------------|---|
| 1200BLKIT | 12" x 12" Catch Basin Kit | Black Grate | 4 | 7.59 | 10ND | 12" x 12" Tapered Catch Basin. Polypropylene. |
| 1200GRKIT | 12" x 12" Catch Basin Kit | Green Grate | 4 | 7.59 | 10ND | |
| 1200KITDISP | 12" x 12" Catch Basin Kits in Display Box | Blk/Grn Grates | 8 | 7.59 | 10ND | Kits include 2-opening Catch Basin, Grate, Screws, 2 Outlets and 1 Plug. DISP includes 4 kits with black grates and 4 green |
| 1200 | 12" x 12" Catch Basin, 2 Openings | Black | 4 | 4.25 | 10ND | |
| 1203 | 12" x 12" Catch Basin, 3 Openings | Black | 4 | 3.75 | 10ND | |
| 1204 | 12" x 12" Catch Basin, 4 Openings | Black | 4 | 3.75 | 10ND | |
| Requires either #1206, #1242, #1243, #1245, #1266 or #1889 Universal Outlet to connect pipe to basin (see page 35). Bottom cutout can be removed. | | | | | | |

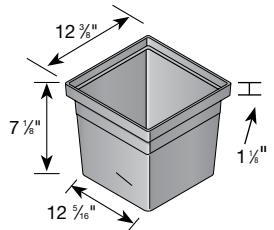

| Part No. | Description | Color | Pkg. Qty. | Wt. Ea. (lbs.) | Product Class | Specifications |
|--|-----------------------------|-------|-----------|----------------|---------------|--|
| 1216 | 12" x 12" Catch Basin Riser | Black | 8 | 2.75 | 10ND | 6" Riser for 12" Catch Basin. Styrene. |
| Use with 12" x 12" Catch Basin Series. Stacks on top of 12" catch basins to add up to 6" to top of basin. Can be cut to size. | | | | | | |

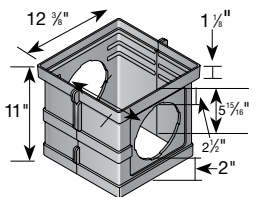

| Part No. | Description | Color | Pkg. Qty. | Wt. Ea. (lbs.) | Product Class | Specifications |
|---|---------------------------------|-------|-----------|----------------|---------------|---------------------------------------|
| 1217 | 12" x 12" Riser with 2 Openings | Black | 4 | 4.00 | 10ND | 12" Riser with Two Openings. Styrene. |
| Nests on top of 12" Catch Basin Series for shallow outlets and 12" Sump Box for more sump area. Requires either #1206, #1242, #1243, #1245, #1266 or #1889 Universal Outlet to connect pipe to riser. | | | | | | |

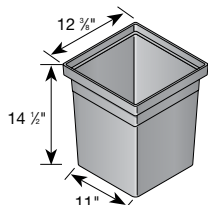

| Part No. | Description | Color | Pkg. Qty. | Wt. Ea. (lbs.) | Product Class | Specifications |
|---|--------------------|-------|-----------|----------------|---------------|----------------------------------|
| 1225 | 12" x 12" Sump Box | Black | 4 | 6.75 | 10ND | One-piece 12" Sump Box. Styrene. |
| Use with 12" x 12" Grate or #1220 Sump/Valve Box Cover. | | | | | | |

DRAINAGE

CATCH BASINS

12" Catch Basin Series (continued)

DRAINAGE

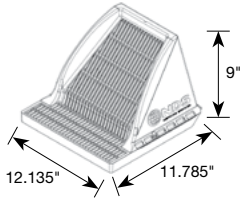

| Part No. | Description | Color | Pkg. Qty. | Wt. Ea. (lbs.) | Product Class | Specifications |
|--|------------------------------------|-------|-----------|----------------|---------------|---|
| 1200DSG | 12" x 12" Downspout Defender Grate | Black | 8 | n/a | 10ND | 12" x 12" Downspout Grate. Structural Foam Polyolefin with UV inhibitor. 247 GPM. |
| Receives downspouts from 2" to 6" round or square. Fits all NDS 12" square Catch Basins, Risers and Low-Profile adapters. | | | | | | |

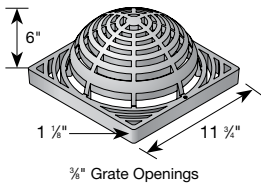

| Part No. | Description | Color | Pkg. Qty. | Wt. Ea. (lbs.) | Product Class | Specifications |
|--|------------------------|-------|-----------|----------------|---------------|--|
| 1280 | 12" x 12" Atrium Grate | Green | 8 | 1.74 | 10ND | 12" Structural Foam Polyolefin Dome Atrium Grate with UV inhibitor. Open surface area 50.60 square inches. 154.79 GPM. |
| 1290 | 12" x 12" Atrium Grate | Black | 8 | 1.74 | 10ND | |
| Use with 12" x 12" Catch Basin Series. | | | | | | |

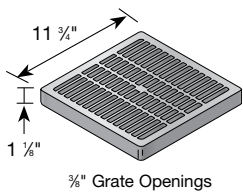

| Part No. | Description | Color | Pkg. Qty. | Wt. Ea. (lbs.) | Product Class | Specifications |
|---|------------------------|-------|-----------|----------------|---------------|---|
| 1210 | 12" x 12" Square Grate | Gray | 8 | 2.33 | 10ND | 12" Square Structural Foam Polyolefin Grate with UV inhibitor. Open surface area 50.76 square inches. 155.28 GPM. |
| 1211 | 12" x 12" Square Grate | Black | 8 | 2.33 | 10ND | |
| 1212 | 12" x 12" Square Grate | Green | 8 | 2.33 | 10ND | |
| 1212S | 12" x 12" Square Grate | Sand | 8 | 2.33 | 10ND | |
|  Use with 12" x 12" Catch Basin Series. (see page 79). ADA Compliant. | | | | | | |

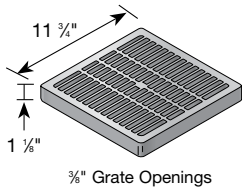

| Part No. | Description | Color | Pkg. Qty. | Wt. Ea. (lbs.) | Product Class | Specifications |
|-------------------------------|------------------------|-------|-----------|----------------|---------------|--|
| 1230B | 12" Square Brass Grate | Brass | 1 | 9.24 | 15BR | Open surface area 42.87 square inches. 131.14 GPM. Includes SS Screws. |
| (see page 79). ADA Compliant. | | | | | | |

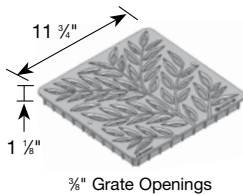

| Part No. | Description | Color | Pkg. Qty. | Wt. Ea. (lbs.) | Product Class | Specifications |
|--|--|-------|-----------|----------------|---------------|--|
| 1218S | 12" x 12" Square Botanical Grate | Sand | 8 | 3.27 | 10ND | 12" Square Structural Foam Polyolefin Botanical Grate with UV inhibitor. Open surface area 24.44 square inches. 74.77 GPM. Class B load rated. |
| 1218GR | 12" x 12" Square Botanical Grate | Green | 8 | 3.27 | 10ND | |
| 1218GY | 12" x 12" Square Botanical Grate | Gray | 8 | 3.27 | 10ND | |
| 1218 | 12" x 12" Square Botanical Grate | Black | 8 | 3.27 | 10ND | |
| 839 | Stainless Steel Screws, FH #6 x 1-3/4" | Metal | 40 | n/a | 10ND | |
|  (see page 79). ADA Compliant. Not compatible with 1200FF filter. | | | | | | |

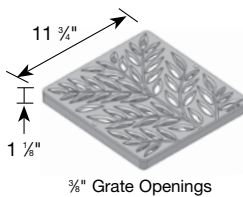

| Part No. | Description | Color | Pkg. Qty. | Wt. Ea. (lbs.) | Product Class | Specifications |
|--|--|--------|-----------|----------------|---------------|---|
| 1218CI | 12" x 12" Square Botanical Cast Iron Grate | Black* | 1 | 12.67 | 10ND | 12" Square Cast Iron Botanical Grate. Open surface area 24.44 square inches. 74.77 GPM. Class B load rated. |
| 629 | Stainless Steel Screws, FH #20 x 1-1/2" | Metal | 40 | n/a | 10ND | |
|  *Painted for shipping & display only; grate will form iron-oxide patina (see page 79). ADA Compliant. | | | | | | |

CATCH BASINS

12" Catch Basin Series (continued)

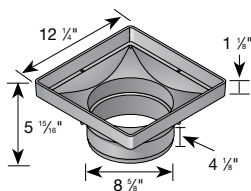
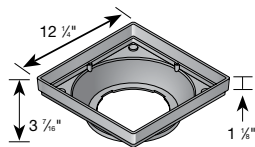
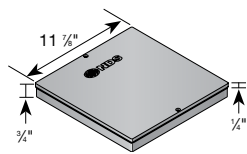
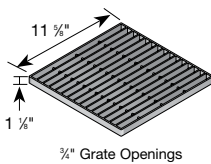
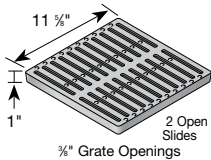
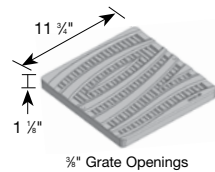
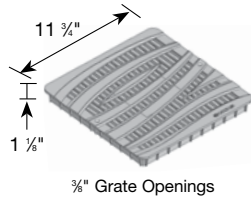

| Part No. | Description | Color | Pkg. Qty. | Wt. Ea. (lbs.) | Product Class | Specifications |
|----------|--|-------|-----------|----------------|---------------|---|
| 1224S | 12" x 12" Square Wave Grate | Sand | 8 | 2.68 | 10ND | 12" Square Structural Foam Polyolefin Wave Grate with UV inhibitor. Open surface area 25.67 square inches. 78.53 GPM. Class B load rated. |
| 1224GR | 12" x 12" Square Wave Grate | Green | 8 | 2.68 | 10ND | |
| 1224GY | 12" x 12" Square Wave Grate | Gray | 8 | 2.68 | 10ND | |
| 1224 | 12" x 12" Square Wave Grate | Black | 8 | 2.68 | 10ND | |
| 839 | Stainless Steel Screws, FH #6 x 1-3/4" | Metal | 40 | n/a | 10ND | |
| | (see page 79). ADA Compliant. | | | | | |

| Part No. | Description | Color | Pkg. Qty. | Wt. Ea. (lbs.) | Product Class | Specifications |
|----------|--|--------|-----------|----------------|---------------|--|
| 1224CI | 12" x 12" Square Wave Cast Iron Grate | Black* | 1 | 13.90 | 10ND | 12" Square Cast Iron Wave Grate. Open surface area 25.60 square inches. 78.31 GPM. Class B load rated. |
| 629 | Stainless Steel Screws, FH #20 x 1-1/2" | Metal | 40 | n/a | 10ND | |
| | *Painted for shipping & display only; grate will form iron-oxide patina (see page 79). ADA Compliant/Heel-proof. | | | | | |

| Part No. | Description | Color | Pkg. Qty. | Wt. Ea. (lbs.) | Product Class | Specifications |
|----------|--|--------|-----------|----------------|---------------|--|
| 1213 | 12" x 12" Square Ductile Iron Grate | Black* | 1 | 15.30 | 10ND | 12" Square Heavy-Duty Ductile Iron Grate. Open surface area 37.20 square inches. 113.80 GPM. |
| | Use with 12" x 12" Catch Basin Series. *Painted for shipping & display only; grate will form iron-oxide patina (see page 79). ADA Compliant. | | | | | |

| Part No. | Description | Color | Pkg. Qty. | Wt. Ea. (lbs.) | Product Class | Specifications |
|----------|--|------------------|-----------|----------------|---------------|---|
| 1215 | 12" x 12" Square Galvanized Steel Grate | Galvanized Steel | 1 | 5.85 | 10ND | 12" Square Heavy-Duty Galvanized Steel Bar Grate. Open surface area 113.78 square inches. 348.07 GPM. |
| | Use with 12" x 12" Catch Basin Series. (see page 79) | | | | | |

| Part No. | Description | Color | Pkg. Qty. | Wt. Ea. (lbs.) | Product Class | Specifications |
|----------|--|-------|-----------|----------------|---------------|---|
| 1220 | 12" x 12" Sump/Valve Box Cover | Black | 8 | 2.23 | 10ND | NDS #1220, 12" Square Structural Foam Polyolefin Solid Cover. |
| | Use with NDS 12" x 12" Catch Basin Series, #1225 Sump Box and #1219 Backwater Valve Box. | | | | | |

| Part No. | Description | Color | Pkg. Qty. | Wt. Ea. (lbs.) | Product Class | Specifications |
|-------------|---|-------------|-----------|----------------|---------------|--|
| 1230 | 12" x 12" Low-Profile Adapter | Black | 8 | 1.25 | 10ND | 12" x 12" Low-Profile Adapter. Styrene. |
| 1230ATBLKIT | 12" x 12" Low-Profile Adapter with Black Atrium Grate and 3" & 4" Universal Locking Outlet | Black Grate | 8 | n/a | 10ND | |
| 1230GRKIT | 12" x 12" Low-Profile Adapter with Flat Green Grate and 3" & 4" Universal Locking Outlet | Green Grate | 8 | n/a | 10ND | Kits contain Low-Profile Adapter, 3" & 4" Universal Locking Outlet and Grate as described. |
| | Adapter alone requires #1242, #1243, #1245, #1266 or #1889 Universal Outlets to connect to 3", 4", 6" or 8" Sewer and Drain or Corrugated Pipes (see page 35). Kits contain #1243 Outlet. | | | | | |

| Part No. | Description | Color | Pkg. Qty. | Wt. Ea. (lbs.) | Product Class | Specifications |
|----------|---|-------|-----------|----------------|---------------|---|
| 1221 | 12" x 12" Square, Low-Profile Adapter – Fits 8" Sewer & Drain Pipe | Black | 12 | 1.92 | 10ND | 12" x 12" Low-Profile Adapter. Styrene. |
| 1222 | 12" x 12" Square, Low-Profile Spigot Adapter – Fits 8" single-wall corrugated pipe, sewer and drain pipe and Schedule 40 pipe | Black | 12 | 1.92 | 10ND | |
| | Use with NDS 12" x 12" Grates | | | | | |

CATCH BASINS

18" Catch Basin Series

DRAINAGE

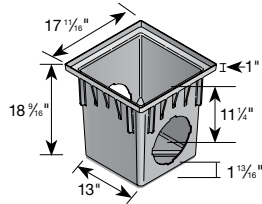

| Part No. | Description | Color | Pkg. Qty. | Wt. Ea. (lbs.) | Product Class | Specifications |
|---|--|-------------|-----------|----------------|---------------|---|
| 1882 | 18" One-Piece Catch Basin 2 Openings | Black | 1 | 10.00 | 10ND | 18"x18" One-Piece Tapered Catch Basin. Structural Foam Polyolefin. Kits include 2-opening Catch Basin, Grate, Screws, 6" Outlet, 8" Outlet, Reducer Rings and Plug |
| 1882BLKIT | 18" Catch Basin Kit with Black Plastic Grate | Black Grate | | 21.00 | 10ND | |
| 1882GRKIT | 18" Catch Basin Kit with Green Plastic Grate | Green Grate | 1 | 21.00 | 10ND | |
| 1884 | 18" One-Piece Catch Basin 4 Openings | Black | 1 | 9.65 | 10ND | |
| Requires either #1206, #1242, #1243, #1245, #1266, #1888 or #1889 Universal Outlet to connect pipe to basin. Includes 2 or 4 #1890 Reducer Rings. | | | | | | |

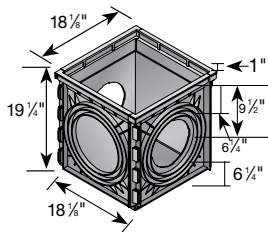

| Part No. | Description | Color | Pkg. Qty. | Wt. Ea. (lbs.) | Product Class | Specifications |
|---|--|-------|-----------|----------------|---------------|---|
| 1800 | 18" x 18" Expandable Catch Basin 2 Openings* | Black | 1 | 16.00 | 10ND | 18" x 18" Modular Catch Basin with Locking Tabs. Styrene. |
| 1804 | 18" x 18" Expandable Catch Basin 4 Openings* | Black | 1 | 16.00 | 10ND | |
| Assembly Required. #1800 includes: 2 #1822, 2 #1820, 1 #1828. #1804 includes: 4 #1822, 1 #1828. Use #1800 and #1804 with #1206, #1243, #1245, #1266 or #1888 Universal Outlets to connect pipes to basin. Includes 2 or 4 #1890 Reducer Rings. (Note: Use Silicone to seal joints.) | | | | | | |

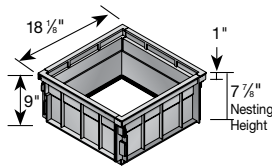

| Part No. | Description | Color | Pkg. Qty. | Wt. Ea. (lbs.) | Product Class | Specifications |
|--|------------------------------|-------|-----------|----------------|---------------|--|
| 1816 | 8" Riser for 18" Catch Basin | Black | 1 | 6.00 | 10ND | 8" Riser for 18" x 18" Catch Basin. Styrene. |
| Riser package includes 4 sides. Use with #1800, #1804, #1882 or #1884. | | | | | | |

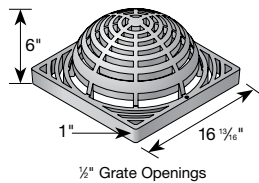

| Part No. | Description | Color | Pkg. Qty. | Wt. Ea. (lbs.) | Product Class | Specifications |
|--|------------------------|-------|-----------|----------------|---------------|--|
| 1881 | 18" x 18" Atrium Grate | Black | 2 | 6.51 | 10ND | 18" Structural Foam Polyolefin Dome Atrium Grate with UV inhibitor. Open surface area 89.40 square inches. 273.49 GPM. |
| 1891 | 18" x 18" Atrium Grate | Green | 2 | 6.51 | 10ND | |
| Use with 18" x 18" Catch Basin Series. | | | | | | |

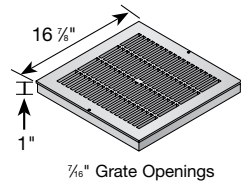

| Part No. | Description | Color | Pkg. Qty. | Wt. Ea. (lbs.) | Product Class | Specifications |
|--|------------------------|-------|-----------|----------------|---------------|---|
| 1810 | 18" x 18" Square Grate | Gray | 4 | 7.72 | 10ND | 18" Square Structural Foam Polyolefin Grate with UV inhibitor. Open surface area 86.31 square inches. 264.03 GPM. |
| 1811 | 18" x 18" Square Grate | Black | 4 | 7.72 | 10ND | |
| 1812 | 18" x 18" Square Grate | Green | 4 | 7.72 | 10ND | |
| Use with 18" x 18" Catch Basin Series. (see page 79). ADA Compliant. | | | | | | |

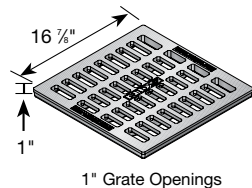

| Part No. | Description | Color | Pkg. Qty. | Wt. Ea. (lbs.) | Product Class | Specifications |
|--|----------------------------------|--------|-----------|----------------|---------------|--|
| 1813 | 18" x 18" Cast Iron Square Grate | Black* | 1 | 46.00 | 10ND | 18" Square Heavy-Duty Cast Iron Grate. Open surface area 110.70 square inches. 338.65 GPM. H-20 Load Rating. |
| Use with 18" x 18" Catch Basin Series. *Painted for shipping & display only; grate will form iron-oxide patina | | | | | | |

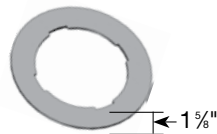

| Part No. | Description | Color | Pkg. Qty. | Wt. Ea. (lbs.) | Product Class | Specifications |
|---|-------------------------------|-------|-----------|----------------|---------------|----------------|
| 1890 | Universal Outlet Reducer Ring | Black | 8 | 0.33 | 10ND | Styrene. |
| Required on #1821 basin side when using 3", 4" or 6" pipe. Required on #1821 basin side when connecting to #1206, #1243, #1245, #1266 or #1889 Universal Outlets. | | | | | | |

CATCH BASINS

18" Catch Basin Series (continued)

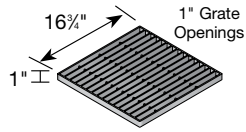

| Part No. | Description | Color | Pkg. Qty. | Wt. Ea. (lbs.) | Product Class | Specifications |
|----------|--|------------------|-----------|----------------|---------------|---|
| 1815 | 18" Square Galvanized Steel Grate | Galvanized Steel | 1 | 10.78 | 10ND | 18" Square Heavy-Duty Galvanized Steel Bar Grate. Open surface area 239.00 square inches. 731.13 GPM. |
| |  Use with 18" x 18" Catch Basin Series. (see page 79) | | | | | |

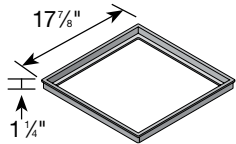

| Part No. | Description | Color | Pkg. Qty. | Wt. Ea. (lbs.) | Product Class | Specifications |
|----------|--|-------|-----------|----------------|---------------|---------------------------|
| 1840 | Frame to adapt 18" x 18" grate to concrete catch basin | Black | 4 | 2.00 | 10ND | 18" x 18" Frame. Styrene. |
| | Use with 18" x 18" Grates. | | | | | |

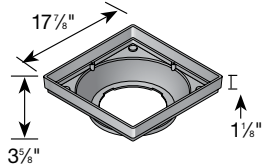

| Part No. | Description | Color | Pkg. Qty. | Wt. Ea. (lbs.) | Product Class | Specifications |
|----------|---|-------|-----------|----------------|---------------|---|
| 1830 | 18" x 18" Low-Profile Adapter | Black | 4 | 4.75 | 10ND | 18" x 18" Low-Profile Adapter. Styrene. |
| | Includes NDS #1890 Reducer Ring. Requires either an NDS #1243, #1245, #1266 or #1888 Universal Outlet to connect to pipe. | | | | | |

DRAINAGE

CATCH BASINS

24" Catch Basin Series

DRAINAGE

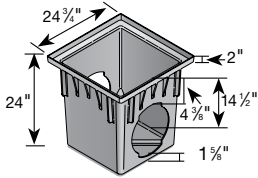

| Part No. | Description | Color | Pkg. Qty. | Wt. Ea. (lbs.) | Product Class | Specifications |
|---|--|-------------|-----------|----------------|---------------|---|
| 2400 | 24" x 24" Catch Basin, 2 Openings | Black | 1 | 18.00 | 10ND | 24" x 24" One-Piece Tapered Catch Basin. HDPE with Structural Foam. |
| 2400BLKIT | 24" Catch Basin Kit with Black Plastic Grate | Black Grate | | 50.00 | 10ND | |
| 2400GRKIT | 24" Catch Basin Kit with Green Plastic Grate | Green Grate | 1 | 50.00 | 10ND | |
| 2404 | 24" x 24" Catch Basin, 4 Openings | Black | 1 | 15.00 | 10ND | Kits include 2-opening Catch Basin, Grate, 12"/10" Outlets, 8" Outlet, Reducer Rings and Plug |
| #2400 & #2404 Require 2 or 4 #2410 Universal Outlets. | | | | | | |

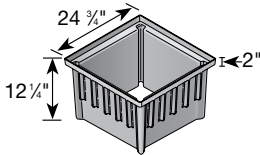

| Part No. | Description | Color | Pkg. Qty. | Wt. Ea. (lbs.) | Product Class | Specifications |
|--|---|-------|-----------|----------------|---------------|--|
| 2418 | 24" x 24" Catch Basin Extension (No Bottom) | Black | 1 | 14.60 | 10ND | 8" Extension for 24" x 24" Catch Basin. HDPE with Structural Foam. |
| Use with 24" x 24" Catch Basin Series. | | | | | | |

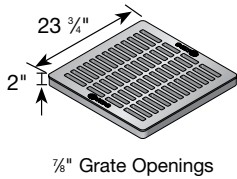

| Part No. | Description | Color | Pkg. Qty. | Wt. Ea. (lbs.) | Product Class | Specifications |
|--|------------------------|-------|-----------|----------------|---------------|---|
| 2411 | 24" x 24" Square Grate | Black | 1 | 19.75 | 10ND | 24" Square HDPE with Structural Foam Grate with UV inhibitor. Open surface area 231.69 square inches. 708.77 GPM. |
| 2412 | 24" x 24" Square Grate | Green | 1 | 19.75 | 10ND | |
| Use with 24" x 24" Catch Basin Series. (see page 79) | | | | | | |

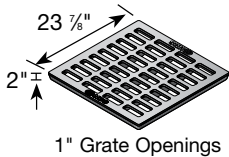

| Part No. | Description | Color | Pkg. Qty. | Wt. Ea. (lbs.) | Product Class | Specifications |
|--|----------------------------------|--------|-----------|----------------|---------------|---|
| 2413 | 24" x 24" Square Cast Iron Grate | Black* | 1 | 147.00 | 10ND | 24" Square Heavy-Duty Cast Iron Grate. Open surface area 197.00 square inches. 602.65 GPM. Structural Foam. |
| Use with 24" x 24" Catch Basin Series. *Painted for shipping & display only; grate will form iron-oxide patina (see page 79) | | | | | | |

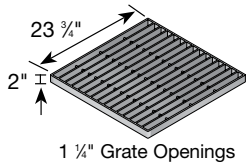

| Part No. | Description | Color | Pkg. Qty. | Wt. Ea. (lbs.) | Product Class | Specifications |
|--|---|------------------|-----------|----------------|---------------|---|
| 2415 | 24" x 24" Square Galvanized Steel Grate | Galvanized Steel | 1 | 62.88 | 10ND | 24" Square Heavy-Duty Galvanized Steel Bar Grate. Open surface area 422.45 square inches. 1292.33 GPM. Structural Foam. |
| Use with 24" x 24" Catch Basin Series. (see page 79) | | | | | | |

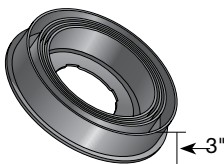

| Part No. | Description | Color | Pkg. Qty. | Wt. Ea. (lbs.) | Product Class | Specifications |
|--|-----------------------------|-------|-----------|----------------|---------------|----------------------------------|
| 2410 | 10" & 12" Universal Adapter | Black | 1 | 4.20 | 10ND | 10"/12" Universal Adapter. HDPE. |
| Includes #1890 (comes pre-inserted). Fits 10" and 12" Sewer and Drain Pipe; 10" and 12" Dual Wall Corrugated Pipe; 12" Single Wall Corrugated Pipe (does not fit 10" Single Wall Corrugated Pipe). Reduces opening to fit most 3" to 8" adapters above (all except #1889) for use with 3", 4", 6" and 8" Sewer and Drain Pipe; 3", 4", 6" and 8" Corrugated Pipe; and 4" Sch. 40 Pipe (select corresponding adapter above). Use with 24" Catch Basin Series. | | | | | | |

CATCH BASINS

Catch Basin Universal Outlets

Universal Outlets and Adapters allow you to quickly connect to 3"-12" drain pipes to accommodate the needs of any job. They offer greater flexibility during install saving time and money.

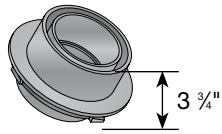

| Part No. | Description | Color | Pkg. Qty. | Wt. Ea. (lbs.) | Product Class | Specifications |
|--|---|-------|-----------|----------------|---------------|------------------------------------|
| 1242 | 3" & 4" Universal Outlet w/4" Internal Spigot | Black | 20 | 0.74 | 10ND | 3" & 4" Universal Outlet. Styrene. |
| Fits 3" & 4" Corrugated Pipe, 3" & 4" Sewer and Drain Pipe, 4" Sch. 40 Pipe, 4" Triple Wall Pipe. Allows for adjusting internal basin invert heights with Sewer and Drain fitting. Use with 9", 12", 18" and 24" Catch Basin Series. Internal spigot fits 4" Sewer and Drain Fittings. Use with 24" Catch Basin also requires #2410 Adapter. | | | | | | |

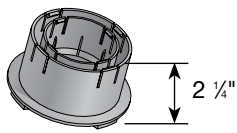

| Part No. | Description | Color | Pkg. Qty. | Wt. Ea. (lbs.) | Product Class | Specifications |
|---|-----------------------------------|-------|-----------|----------------|---------------|---|
| 1243 | 3" & 4" Universal Locking Outlet* | Black | 20 | 0.60 | 10ND | 3" & 4" Patented Universal Locking Outlet. Styrene. |
| Fits 3" & 4" Corrugated Pipe, 3" & 4" Sewer and Drain Pipe, 4" Sch. 40 Pipe and 3" & 4" Triple Wall Pipe. Use with 9", 12", 18" and 24" Catch Basin Series and #930, #1230, #1830 and #2410 Adapters. Use with 24" Catch Basin also requires #2410 Adapter. | | | | | | |
| *Locking Outlet snaps on to most 3" and 4" corrugated pipe. | | | | | | |

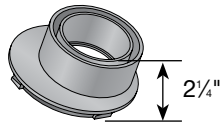

| Part No. | Description | Color | Pkg. Qty. | Wt. Ea. (lbs.) | Product Class | Specifications |
|--|---------------------------------|-------|-----------|----------------|---------------|---|
| 1245 | 3" & 4" Offset Universal Outlet | Black | 20 | 0.50 | 10ND | 3" & 4" Offset Universal Outlet. Styrene. |
| Fits 3" & 4" Corrugated Pipe, 3" & 4" Sewer and Drain Pipe, 4" Sch. 40 Pipe, 4" Triple Wall Pipe. Allows for adjusting inlet height. Use with 9", 12", 18" and 24" Catch Basin Series. Use with 24" Catch Basin also requires #2410 Adapter. | | | | | | |

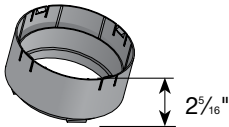

| Part No. | Description | Color | Pkg. Qty. | Wt. Ea. (lbs.) | Product Class | Specifications |
|--|------------------------------|-------|-----------|----------------|---------------|---------------------------------------|
| 1266 | 6" Universal Locking Outlet* | Black | 20 | 0.55 | 10ND | 6" Universal Locking Outlet. Styrene. |
| Fits 6" Sewer and Drain Pipe, 6" Corrugated Pipe. Use with 9", 12", 18" and 24" Catch Basin Series and #930, #1230 and #1830 Low-Profile Adapters. Use with 24" Catch Basin also requires #2410 Adapter. | | | | | | |
| *Locking Outlet snaps on to most 6" corrugated pipe. | | | | | | |

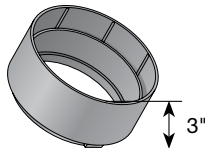

| Part No. | Description | Color | Pkg. Qty. | Wt. Ea. (lbs.) | Product Class | Specifications |
|--|---------------------|-------|-----------|----------------|---------------|-------------------------------|
| 1888 | 8" Universal Outlet | Black | 8 | 1.05 | 10ND | 8" Universal Outlet. Styrene. |
| Fits 8" Sewer and Drain Pipe, 8" Corrugated Pipe. Use with 18" and 24" Catch Basin Series. Use with 24" Catch Basin also requires #2410 Adapter. | | | | | | |

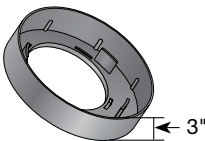

| Part No. | Description | Color | Pkg. Qty. | Wt. Ea. (lbs.) | Product Class | Specifications |
|--|-----------------------------|-------|-----------|----------------|---------------|---------------------------------------|
| 1889 | 8" Offset Universal Adapter | Black | 10 | 0.74 | 10ND | 8" Offset Universal Adapter. Styrene. |
| Fits 8" Sewer and Drain Pipe, 8" Corrugated Pipe. Use with 12" and most 18" Catch Basin Series (except 1800 and 1804). | | | | | | |

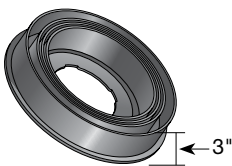

| Part No. | Description | Color | Pkg. Qty. | Wt. Ea. (lbs.) | Product Class | Specifications |
|--|-----------------------------|-------|-----------|----------------|---------------|----------------------------------|
| 2410 | 10" & 12" Universal Adapter | Black | 1 | 4.20 | 10ND | 10"/12" Universal Adapter. HDPE. |
| Includes #1890 (comes pre-inserted). Fits 10" and 12" Sewer and Drain Pipe; 10" and 12" Dual Wall Corrugated Pipe; 12" Single Wall Corrugated Pipe (does not fit 10" Single Wall Corrugated Pipe). Reduces opening to fit most 3" to 8" adapters above (all except #1889) for use with 3", 4", 6" and 8" Sewer and Drain Pipe; 3", 4", 6" and 8" Corrugated Pipe; and 4" Sch. 40 Pipe (select corresponding adapter above). Use with 24" Catch Basin Series. | | | | | | |

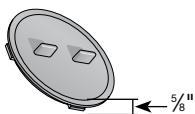

| Part No. | Description | Color | Pkg. Qty. | Wt. Ea. (lbs.) | Product Class | Specifications |
|----------|---------------------------|-------|-----------|----------------|---------------|--------------------------|
| 1206 | 6" Universal Adapter Plug | Black | 20 | 0.35 | 10ND | Universal Plug. Styrene. |

POP-UP DRAINAGE EMITTERS

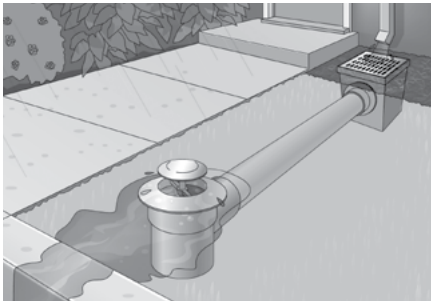

The Pop-up Drainage Emitter is an easy, safe and efficient solution that allows water to be diverted and released to water-safe areas away from structures, erosion-prone landscapes and poor drainage areas.

Pop-up Drainage Emitters allow water captured by grates, catch basins, channel drains, Flo-Well, EZflow, downspouts and roof gutter systems to flow through drainage pipe and away from structural foundations to safe or useful areas. For example, water can be routed from a low area next to a foundation to a water-safe area in the landscape, or a curbside drainage system where allowed. The emitter opens under minimal hydrostatic pressure from water through upstream drainage pipes; the emitter closes as flow diminishes. The special patented design allows the Emitter to open with even the smallest flows. Since the Emitter is closed during dry weather, debris and rodents cannot enter the drain pipes. Spring automatically retracts – closes and prevents damage from lawn mowers. It's flat profile blends discreetly into the surrounding landscapes.

3" & 4" Pop-up Drainage Emitter

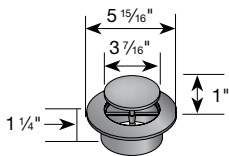

| Part No. | Description | Color | Pkg. Qty. | Wt. Ea. (lbs.) | Product Class | Specifications |
|----------|--|-------|-----------|----------------|---------------|---|
| 420 | 3" & 4" Pop-up Drainage Emitter Fits 3" and 4" Sewer and Drain Fittings. Ideal for discharging excess water from stormwater management system. Spring automatically retracts. | Green | 20 | 0.28 | 10ND | 3" and 4" polyolefin spring-loaded Pop-up Drainage Emitter with UV inhibitor. 40 GPM capacity. 0.04 psi or 1" of head to raise top. |

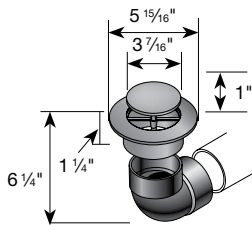

| Part No. | Description | Color | Pkg. Qty. | Wt. Ea. (lbs.) | Product Class | Specifications |
|----------|---|-------|-----------|----------------|---------------|--|
| 321 | Emitter with 3" Elbow Fits 3" Sewer and Drain Pipe. Ideal for discharging excess water from stormwater management system. Spring automatically retracts. | Green | 25 | 0.60 | 10ND | NDS #420 polyolefin spring-loaded Pop-up Drainage Emitter with UV inhibitor, 3" styrene 90 degree elbow with 1/4" drain hole. 40 GPM. 0.04 psi or 1" of head to raise top. |

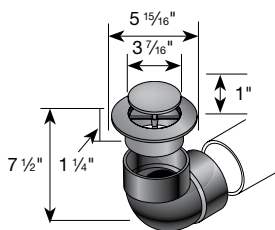

| Part No. | Description | Color | Pkg. Qty. | Wt. Ea. (lbs.) | Product Class | Specifications |
|----------|---|-------|-----------|----------------|---------------|--|
| 421 | Emitter with 4" Elbow Fits 4" Sewer and Drain Pipe. Ideal for discharging excess water from stormwater management system. Spring automatically retracts. | Green | 20 | 0.85 | 10ND | NDS #420 polyolefin spring-loaded Pop-up Drainage Emitter with UV inhibitor, 4" styrene 90 degree elbow with 1/4" drain hole. 40 GPM. 0.04 psi or 1" of head to raise top. |

POP-UP DRAINAGE EMITTERS

3" & 4" Pop-up Drainage Emitter (continued)

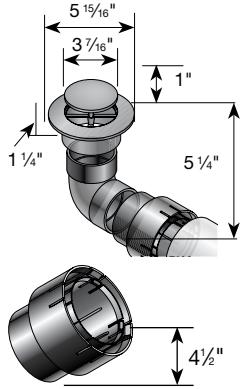

| Part No. | Description | Color | Pkg. Qty. | Wt. Ea. (lbs.) | Product Class | Specifications |
|----------|---|-------|-----------|----------------|---------------|---|
| 430 | Pop-up Drainage Emitter with 3" Elbow and Universal Adapter | Green | 20 | 1.00 | 10ND | NDS #420 polyolefin spring-loaded Pop-up Drainage Emitter with UV inhibitor, 3" styrene 90 degree elbow with 1/4" drain hole and universal pipe adapter. 40 GPM. 0.04 psi or 1" of head to raise top. |
| 1241 | 3" & 4" Universal Adapter w/4" Spigot | Black | 20 | 0.70 | 10ND | 3" & 4" Patented Universal Adapter. Styrene. Connects 3" & 4" Sewer and Drain Fittings with 3" & 4" Corrugated Pipe, 3" & 4" Sewer and Drain Pipe, 4" Sch. 40 Pipe and 3" & 4" Triple Wall Pipe. |

DRAINAGE

6" Pop-up Drainage Emitter

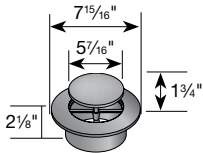

| Part No. | Description | Color | Pkg. Qty. | Wt. Ea. (lbs.) | Product Class | Specifications |
|----------|----------------------------|-------|-----------|----------------|---------------|--|
| 620 | 6" Pop-up Drainage Emitter | Green | 15 | 0.61 | 10ND | 6" polyolefin spring-loaded Pop-up Drainage Emitter with UV inhibitor. 88 GPM capacity. 0.04 psi or 1" of head to raise top. Can be used with Flo-Well to relieve overflow. |

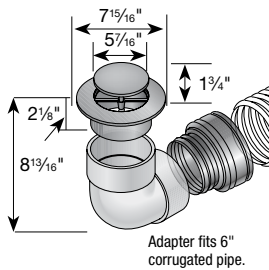

| Part No. | Description | Color | Pkg. Qty. | Wt. Ea. (lbs.) | Product Class | Specifications |
|----------|--|-------|-----------|----------------|---------------|--|
| 624 | 6" Pop-up Emitter with Elbow and Corrugated Pipe Adapter | Green | 10 | 3.45 | 10ND | NDS #620 polyolefin spring-loaded Pop-up Drainage Emitter with UV inhibitor, 6" styrene 90 degree elbow with 1/4" drain hole and corrugated pipe adapter. 88 GPM. 0.04 psi or 1" of head to raise top. |

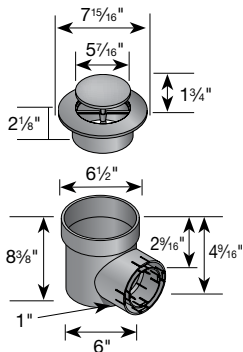

| Part No. | Description | Color | Pkg. Qty. | Wt. Ea. (lbs.) | Product Class | Specifications |
|----------|--------------------------------------|-------|-----------|----------------|---------------|--|
| 625 | 6" Pop-up Emitter with Spee-D® Basin | Green | 8 | 2.21 | 10ND | NDS #620 polyolefin spring-loaded Pop-up Drainage Emitter with UV inhibitor and Spee-D basin. 88 GPM. 0.04 psi or 1" of head to raise top. |

COMMON DRAINAGE FITTINGS

90 Degree PVC Elbow

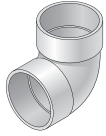

| Part No. | Description | Color | Pkg. Qty. | Wt. Ea. (lbs.) | Product Class |
|----------|------------------------------------|-------|-----------|----------------|---------------|
| 3P02 | 3" PVC 90 Degree Elbow (HUB x HUB) | White | 40 | 0.40 | 30PV |
| 4P02 | 4" PVC 90 Degree Elbow (HUB x HUB) | White | 25 | 0.68 | 30PV |
| 6P02 | 6" PVC 90 Degree Elbow (HUB x HUB) | White | 12 | 3.00 | 30PV |

Corrugated Adapter

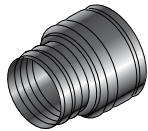

| Part No. | Description | Color | Pkg. Qty. | Wt. Ea. (lbs.) | Product Class |
|----------|--|-------|-----------|----------------|---------------|
| 351 | 3" Polyethylene Corrugated Adapter (CORR HUB x S&D SPT or HUB) | Black | 50 | 0.10 | 30ST |
| 451 | 4" Polyethylene Corrugated Adapter (CORR HUB x S&D SPT or HUB) | Black | 25 | 0.20 | 30ST |
| 651 | 6" Polyethylene Corrugated Adapter (CORR HUB x S&D SPT or HUB) | Black | 12 | 0.25 | 30ST |

Corrugated Internal Couplings

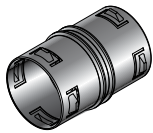

| Part No. | Description | Color | Pkg. Qty. | Wt. Ea. (lbs.) | Product Class |
|----------|------------------------|-------|-----------|----------------|---------------|
| 3C05 | 3" Corrugated Coupling | Black | 60 | 0.07 | 30PE |
| 4C07 | 4" Corrugated Coupling | Black | 36 | 0.08 | 30PE |
| 6C07 | 6" Corrugated Coupling | Black | 12 | 0.08 | 30PE |

Corrugated End Caps



| Part No. | Description | Color | Pkg. Qty. | Wt. Ea. (lbs.) | Product Class |
|----------|----------------------|-------|-----------|----------------|---------------|
| 3C06 | 3" Corrugated Endcap | Black | 33 | 0.05 | 30PE |
| 4C06 | 4" Corrugated Endcap | Black | 30 | 0.06 | 30PE |
| 6C06 | 6" Corrugated Endcap | Black | 15 | 0.50 | 30PE |

Note: See Fittings section (pages 170-189) for additional fitting options.

GRATES: STANDARD, DECORATIVE & METAL



NDS offers a variety of grates in sizes, patterns, colors and design options to fit all products and enhance any landscape.

DRAINAGE

Brass & Chrome Grates



Strong – Practical – Functional

Our solid cast brass grates are secured to a PVC collar with solid brass screws for aesthetics and reliability. The PVC collar can be solvent welded into sewer and drain fittings or pipe where permanent, anti-theft installation is desired. The grate can still be removed for easy cleanout.

- A unique mix of beauty and function
- Recommended for highly-visible entry areas in hotels, malls, office buildings, country clubs and estates
- Exceptional construction and fine finish also make these grates ideal for deck areas, walkways, swimming pools and spas

Materials & Standards

- Made with the highest-quality solid brass
- Brushed Satin and Polished Chrome finishes are protected by a clear plastic film that prevents damage to the finish during shipping and installation

GRATES: STANDARD, DECORATIVE & METAL

Brass & Chrome Grates

DRAINAGE

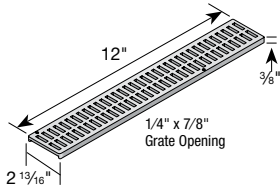

| Part No. | Description | Color | Pkg. Qty. | Wt. Ea. lbs. | Product Class | Specifications |
|---|---------------------------|----------------|-----------|--------------|---------------|---|
| 552B | 1 ft. Brass Channel Grate | Satin Brass | 12 | 1.21 | 25PF | 1 foot Mini Channel Solid Brass Grate with brass screws. Open surface area 9.20 square inches per foot. 28.14 GPM per foot. |
| 553PB | 1 ft. Brass Channel Grate | Polished Brass | 12 | 1.21 | 25PF | |
|  Fits #500 and #550 Mini Channels. (see pages 50). (see page 79). ADA Compliant/Heel-proof. | | | | | | |

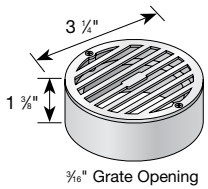

| Part No. | Description | Color | Pkg. Qty. | Wt. Ea. lbs. | Product Class | Specifications |
|--|-----------------------------------|----------------|-----------|--------------|---------------|--|
| 909B | 3" Round Brass Grate w/PVC Collar | Satin Brass | 20 | 0.40 | 15BR | 3" Round Solid Brass Grate and brass screws with PVC collar. Open surface area 2.68 square inches. 8.20 GPM. |
| 905PB | 3" Round Brass Grate w/PVC Collar | Polished Brass | 20 | 0.40 | 15BR | |
|  Fits 2" SCH-40 Pipe and 3" Sewer and Drain Fittings. (see page 79). ADA Compliant/Heel-proof. | | | | | | |

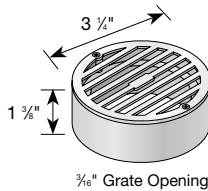

| Part No. | Description | Color | Pkg. Qty. | Wt. Ea. lbs. | Product Class | Specifications |
|--|------------------------------------|-----------------|-----------|--------------|---------------|---|
| 915SC | 3" Round Chrome Grate w/PVC Collar | Satin Chrome | 20 | 0.40 | 15BR | 3" Round Solid Chrome Grate and screws with PVC collar. Open surface area 2.68 square inches. 8.20 GPM. |
| 907PC | 3" Round Chrome Grate w/PVC Collar | Polished Chrome | 20 | 0.40 | 15BR | |
|  Fits 3" Sewer and Drain Fittings and 2" SCH-40 Pipe. (see page 79). ADA Compliant/Heel-proof. | | | | | | |

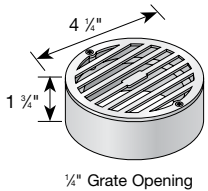

| Part No. | Description | Color | Pkg. Qty. | Wt. Ea. lbs. | Product Class | Specifications |
|--|-----------------------------------|----------------|-----------|--------------|---------------|---|
| 910B | 4" Round Brass Grate w/PVC Collar | Satin Brass | 20 | 0.64 | 15BR | 4" Round Solid Brass Grate and brass screws with PVC collar. Open surface area 5.25 square inches. 16.06 GPM. |
| 906PB | 4" Round Brass Grate w/PVC Collar | Polished Brass | 20 | 0.64 | 15BR | |
|  Fits 3" Sewer & Drain Pipe, 4" Sewer & Drain Fittings. (see page 79). ADA Compliant/Heel-proof. | | | | | | |

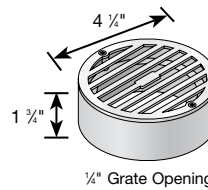

| Part No. | Description | Color | Pkg. Qty. | Wt. Ea. lbs. | Product Class | Specifications |
|--|------------------------------------|-----------------|-----------|--------------|---------------|--|
| 917SC | 4" Round Chrome Grate w/PVC Collar | Satin Chrome | 20 | 0.66 | 15BR | 4" Round Chrome Grate and screws with PVC collar. Open surface area 5.25 square inches. 16.06 GPM. |
| 908PC | 4" Round Chrome Grate w/PVC Collar | Polished Chrome | 20 | 0.66 | 15BR | |
|  Fits 3" Sewer & Drain Pipe, 4" Sewer & Drain Fittings. (see page 79). ADA Compliant/Heel-proof. | | | | | | |

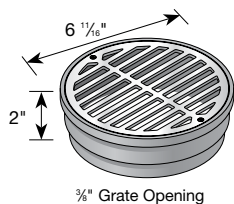

| Part No. | Description | Color | Pkg. Qty. | Wt. Ea. lbs. | Product Class | Specifications |
|---|---------------------------------------|----------------|-----------|--------------|---------------|--|
| 918B | 6" Round Brass Grate w/Styrene Collar | Satin Brass | 8 | 1.38 | 15BR | 6" Round Solid Brass Grate and brass screws with styrene collar. Open surface area 13.10 square inches. 40.07 GPM. |
| 919PB | 6" Round Brass Grate w/Styrene Collar | Polished Brass | 8 | 1.38 | 15BR | |
|  Fits Spee-D® Basin, 6" Sewer & Drain Fittings. (see page 79). ADA Compliant. | | | | | | |

GRATES: STANDARD, DECORATIVE & METAL

Brass & Chrome Grates (continued)

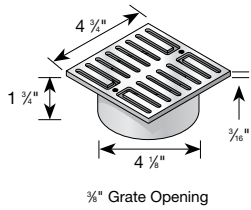

| Part No. | Description | Color | Pkg. Qty. | Wt. Ea. lbs. | Product Class | Specifications |
|--|------------------------------------|----------------|-----------|--------------|---------------|--|
| 913B | 5" Square Brass Grate w/PVC Collar | Satin Brass | 10 | 1.21 | 15BR | 5" Square Solid Brass Grate with brass screws and PVC collar. Open surface area 2.5 square inches. 7.65 GPM. |
| 914PB | 5" Square Brass Grate w/PVC Collar | Polished Brass | 10 | 1.21 | 15BR | |
|  Fits 4" Sewer and Drain Fittings, 3" Sewer and Drain Pipe, and 3" Triple Wall Pipe. (see page 79). ADA Compliant. | | | | | | |

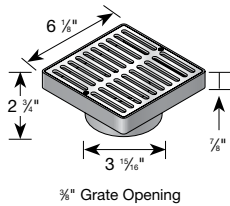

| Part No. | Description | Color | Pkg. Qty. | Wt. Ea. lbs. | Product Class | Specifications |
|---|---|----------------|-----------|--------------|---------------|--|
| 920B | 6" Square Brass Grate w/Styrene Adapter | Satin Brass | 8 | 1.65 | 15BR | 6" Square Solid Brass Grate with brass-colored styrene low-profile adapter and brass screws. Open surface area 11.60 square inches. 35.49 GPM. |
| 923PB | 6" Square Brass Grate w/Styrene Adapter | Polished Brass | 8 | 1.65 | 15BR | |
|  Fits 3" or 4" Sewer and Drain Pipe or Fittings, 3" or 4" Corrugated Pipe, and 3" or 4" Triple Wall Pipe. (see page 79). ADA Compliant. | | | | | | |

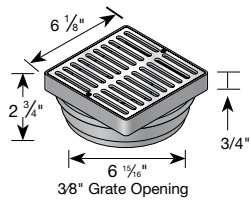

| Part No. | Description | Color | Pkg. Qty. | Wt. Ea. lbs. | Product Class | Specifications |
|--|---|----------------|-----------|--------------|---------------|--|
| 921B | 6" Square Brass Grate w/Styrene Adapter | Satin Brass | 8 | 1.71 | 15BR | 6" Square Solid Brass Grate with brass-colored styrene low-profile adapter and brass screws. Open surface area 11.60 square inches. 35.49 GPM. |
| 922PB | 6" Square Brass Grate w/Styrene Adapter | Polished Brass | 8 | 1.70 | 15BR | |
|  Fits Spee-D® Basin, 6" Sewer and Drain Pipe & Fittings. (see page 79). ADA Compliant. | | | | | | |

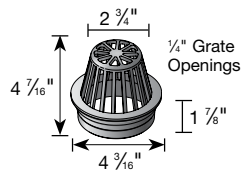

| Part No. | Description | Color | Pkg. Qty. | Wt. Ea. lbs. | Product Class | Specifications |
|--|-----------------------|-------|-----------|--------------|---------------|---|
| 78B | 4" Atrium Brass Grate | Brass | 1 | 2.00 | 15BR | Open surface area 10.20 square inches. 31.20 GPM. |
|  Fits 4" Sewer and Drain Pipe & Fittings. | | | | | | |

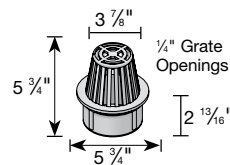

| Part No. | Description | Color | Pkg. Qty. | Wt. Ea. lbs. | Product Class | Specifications |
|--|-----------------------|-------|-----------|--------------|---------------|---|
| 90B | 6" Atrium Brass Grate | Brass | 1 | 5.30 | 15BR | Open surface area 22.50 square inches. 68.83 GPM. |
|  Fits 6" Sewer and Drain Pipe & Fittings. | | | | | | |

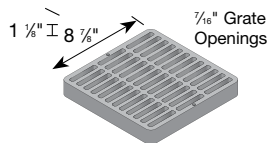

| Part No. | Description | Color | Pkg. Qty. | Wt. Ea. lbs. | Product Class | Specifications |
|---|-----------------------|-------|-----------|--------------|---------------|--|
| 930B | 9" Square Brass Grate | Brass | 1 | 5.11 | 15BR | Open surface area 34.00 square inches. 104.01 GPM. Includes SS Screws. |
|  (see page 79). ADA Compliant. | | | | | | |

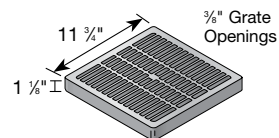

| Part No. | Description | Color | Pkg. Qty. | Wt. Ea. lbs. | Product Class | Specifications |
|---|------------------------|-------|-----------|--------------|---------------|--|
| 1230B | 12" Square Brass Grate | Brass | 1 | 9.24 | 15BR | Open surface area 42.87 square inches. 131.14 GPM. Includes SS Screws. |
|  (see page 79). ADA Compliant. | | | | | | |

GRATES: STANDARD, DECORATIVE & METAL

Decorative Grates

Designed to meet today's demand for products that are as beautiful as they are functional. NDS decorative grates feature consumer-tested designs and offer a range of colors and materials ideal for any application or setting.



DRAINAGE

Catch Basin Plastic & Metal Decorative Grates

Fits 12" Catch Basins. Available in Botanical and Wave designs, in multiple colors or in cast iron. Plastic grates are "T-top" and overlap basin edge. Iron grates sit flush.

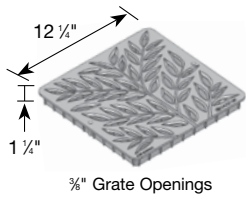

| Part No. | Description | Color | Pkg. Qty. | Wt. Ea. (lbs.) | Product Class | Specifications |
|---|----------------------------------|-------|-----------|----------------|---------------|--|
| 1218S | 12" x 12" Square Botanical Grate | Sand | 8 | 3.27 | 10ND | 12" Square Structural Foam Polyolefin Botanical Grate with UV inhibitor. Open surface area 24.44 square inches. 74.77 GPM. Class B load rated. |
| 1218GR | 12" x 12" Square Botanical Grate | Green | 8 | 3.27 | 10ND | |
| 1218GY | 12" x 12" Square Botanical Grate | Gray | 8 | 3.27 | 10ND | |
| 1218 | 12" x 12" Square Botanical Grate | Black | 8 | 3.27 | 10ND | |
| 839 | #6 x 1-3/4 FH Phillips Screw | Metal | 40 | n/a | 10ND | |
| Use Screw # 839, FH#6 x 1-3/4". (see page 79). ADA Compliant. | | | | | | |

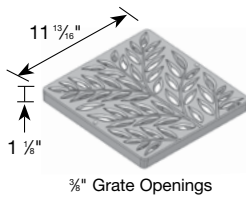

| Part No. | Description | Color | Pkg. Qty. | Wt. Ea. (lbs.) | Product Class | Specifications |
|--|--|--------|-----------|----------------|---------------|---|
| 1218CI | 12" x 12" Square Botanical Cast Iron Grate | Black* | 1 | 12.67 | 10ND | 12" Square Cast Iron Botanical Grate. Open surface area 24.44 square inches. 74.77 GPM. Class B load rated. |
| 629 | #20 x 1-1/2 FH Phillips Screw | Metal | 40 | n/a | 10ND | |
| Use Screw # 629, FH#20 x 1-1/2". *Painted for shipping & display only; grate will form iron-oxide patina (see page 79). ADA Compliant. | | | | | | |

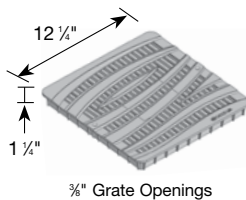

| Part No. | Description | Color | Pkg. Qty. | Wt. Ea. (lbs.) | Product Class | Specifications |
|---|------------------------------|-------|-----------|----------------|---------------|---|
| 1224S | 12" x 12" Square Wave Grate | Sand | 8 | 2.68 | 10ND | 12" Square Structural Foam Polyolefin Wave Grate with UV inhibitor. Open surface area 25.67 square inches. 78.53 GPM. Class B load rated. |
| 1224GR | 12" x 12" Square Wave Grate | Green | 8 | 2.68 | 10ND | |
| 1224GY | 12" x 12" Square Wave Grate | Gray | 8 | 2.68 | 10ND | |
| 1224 | 12" x 12" Square Wave Grate | Black | 8 | 2.68 | 10ND | |
| 839 | #6 x 1-3/4 FH Phillips Screw | Metal | 40 | n/a | 10ND | |
| Use Screw # 839, FH#6 x 1-3/4". (see page 79). ADA Compliant. | | | | | | |

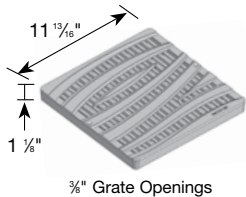

| Part No. | Description | Color | Pkg. Qty. | Wt. Ea. (lbs.) | Product Class | Specifications |
|--|---------------------------------------|--------|-----------|----------------|---------------|--|
| 1224CI | 12" x 12" Square Wave Cast Iron Grate | Black* | 1 | 13.90 | 10ND | 12" Square Cast Iron Wave Grate. Open surface area 25.60 square inches. 78.31 GPM. Class B load rated. |
| 629 | #20 x 1-1/2 FH Phillips Screw | Metal | 40 | n/a | 10ND | |
| Use Screw # 629, FH#20 x 1-1/2". *Painted for shipping & display only; grate will form iron-oxide patina (see page 79). ADA Compliant. | | | | | | |

GRATES: STANDARD, DECORATIVE & METAL

Slim Channel Plastic Decorative Grates

Excellent for light duty applications, including residential pools, concrete and paver patios, spas, walkways and paver landscapes.

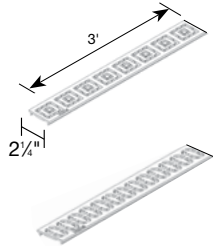

| Part No. | Description | Color | Pkg. Qty. | Wt. Ea. (lbs.) | Product Class | Specifications |
|---|---|-------|---------------|----------------|---------------|--|
| 9251 | 3 ft. Slim Channel Grate Square | White | 30 EA (90 LF) | 0.36 | 25PF | 3 ft Polypropylene Decorative Square Channel Grate with UV inhibitor. Open Surface Area 5.73 square inches per foot. 21.44 GPM per foot. |
| 9252 | 3 ft. Slim Channel Grate Square | Sand | 30 EA (90 LF) | 0.36 | 25PF | |
| 9253 | 3 ft. Slim Channel Grate Square | Gray | 30 EA (90 LF) | 0.36 | 25PF | |
| 9261 | 3 ft. Slim Channel Grate Chain | White | 30 EA (90 LF) | 0.36 | 25PF | 3 ft Polypropylene Decorative Chain Channel Grate with UV inhibitor. Open Surface Area 5.73 square inches per foot. 21.44 GPM per foot. |
| 9262 | 3 ft. Slim Channel Grate Chain | Sand | 30 EA (90 LF) | 0.36 | 25PF | |
| 9263 | 3 ft. Slim Channel Grate Chain | Gray | 30 EA (90 LF) | 0.36 | 25PF | |
|  | (see page 79). ADA Compliant/Heel-proof | | | | | |

DRAINAGE

Mini Channel Plastic & Metal Decorative Grates

Fits 500 Series Mini Channel. Available in Botanical and Wave designs, in multiple colors or in cast iron. Plastic grates are "T-top" and overlap basin edge. Iron grates sit flush.

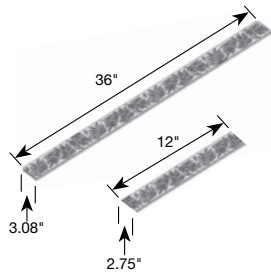

| Part No. | Description | Color | Pkg. Qty. | Wt. Ea. (lbs.) | Product Class | Specifications |
|----------|--------------------------------------|--------|-----------|----------------|--|--|
| 846 | Stainless Steel Screws, FH #4 x 5/8" | Steel | 64 | 0.10 | 25PF | 3 ft. Structural Foam Polyolefin botanical pattern Channel Grate with UV inhibitor. Open surface area 5.44 square inches per foot. 16.64 GPM per foot. |
| 554S | 3' Botanical Channel Grate | Sand | 16 | 0.89 | 1 ft. Mini Channel botanical Cast Iron Channel Grate. Open surface area 5.39 square inches per foot. 16.49 GPM per foot. Class B load rated. | |
| 554GR | 3' Botanical Channel Grate | Green | 16 | 0.89 | | |
| 554GY | 3' Botanical Channel Grate | Gray | 16 | 0.89 | | |
| 554 | 3' Botanical Channel Grate | Black | 16 | 0.89 | | |
| 554CI | 1' Botanical Cast Iron Channel Grate | Black* | 1 | 1.82 | 10ND | |
| 629 | #20 x 1-1/2 FH Phillips Screw | Metal | 40 | n/a | 10ND | *Painted for shipping & display only; grate will form iron-oxide patina (see page 79). ADA Compliant. |

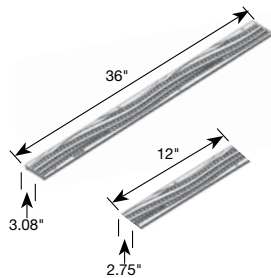

| Part No. | Description | Color | Pkg. Qty. | Wt. Ea. (lbs.) | Product Class | Specifications |
|----------|--------------------------------------|--------|-----------|----------------|---|---|
| 846 | Stainless Steel Screws, FH #4 x 5/8" | Steel | 64 | 0.10 | 25PF | 3 ft. Structural Foam Polyolefin wave pattern Channel Grate with UV inhibitor. Open surface area 5.73 square inches per foot. 17.54 GPM per foot. |
| 555S | 3' Wave Channel Grate | Sand | 16 | 0.88 | 1 ft. Mini Channel Wave Cast Iron Channel Grate. Open surface area 4.11 square inches per foot. 12.56 GPM per foot. Class B load rated. | |
| 555GR | 3' Wave Channel Grate | Green | 16 | 0.88 | | |
| 555GY | 3' Wave Channel Grate | Gray | 16 | 0.88 | | |
| 555 | 3' Wave Channel Grate | Black | 16 | 0.88 | | |
| 555CI | 1' Wave Cast Iron Channel Grate | Black* | 1 | 1.30 | 10ND | |
| 629 | #20 x 1-1/2 FH Phillips Screw | Metal | 40 | n/a | 10ND | *Painted for shipping & display only; grate will form iron-oxide patina (see page 79). ADA Compliant. |

GRATES: STANDARD, DECORATIVE & METAL

Spee-D® Channel Plastic & Metal Decorative Grates

Fits Spee-D® Channel. Available in Botanical and Wave designs, in multiple colors or in cast iron. Plastic grates are "T-top" and overlap basin edge. Iron grates sit flush.

DRAINAGE

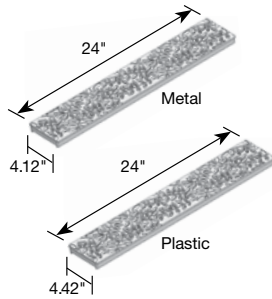

| Part No. | Description | Color | Pkg. Qty. | Wt. Ea. (lbs.) | Product Class | Specifications |
|---|--------------------------------------|--------|-----------|----------------|---------------|---|
| 829 | Stainless Steel Screws, FH #8 x 1" | Steel | 48 | 0.06 | 25PF | 2 ft. Structural Foam Polyolefin decorative botanical Channel Grate with UV inhibitor. Open surface area 7.78 square inches per foot. 23.80 GPM per foot. |
| 252S | 2' Channel Botanical Grate | Sand | 24 ft. | 1.74 | 25PF | |
| 252GR | 2' Channel Botanical Grate | Green | 24 ft. | 1.74 | 25PF | |
| 252GY | 2' Channel Botanical Grate | Gray | 24 ft. | 1.74 | 25PF | |
| 252 | 2' Channel Botanical Grate | Black | 24 ft. | 1.74 | 25PF | |
| 252CI | 2' Cast Iron Channel Botanical Grate | Black* | 1 ft. | 7.06 | 25PF | |
| 629 | #20 x 1-1/2 FH Phillips Screw | Metal | 40 | n/a | 10ND | |
| *Painted for shipping & display only; grate will form iron-oxide patina (see page 79). ADA Compliant. | | | | | | |

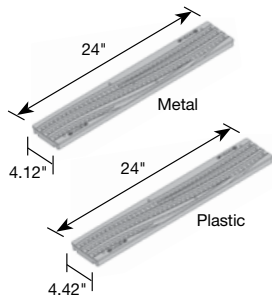

| Part No. | Description | Color | Pkg. Qty. | Wt. Ea. (lbs.) | Product Class | Specifications |
|---|------------------------------------|--------|-----------|----------------|---------------|--|
| 829 | Stainless Steel Screws, FH #8 x 1" | Steel | 48 | 0.06 | 25PF | 2 ft. Structural Foam Polyolefin decorative wave Channel Grate with UV inhibitor. Open surface area 7.78 square inches per foot. 23.80 GPM per foot. |
| 253S | 2' Channel Wave Grate | Sand | 24 ft. | 1.84 | 25PF | |
| 253GR | 2' Channel Wave Grate | Green | 24 ft. | 1.84 | 25PF | |
| 253GY | 2' Channel Wave Grate | Gray | 24 ft. | 1.84 | 25PF | |
| 253 | 2' Channel Wave Grate | Black | 24 ft. | 1.84 | 25PF | |
| 253CI | 2' Cast Iron Channel Wave Grate | Black* | 2 ft. | 7.52 | 25PF | |
| 629 | #20 x 1-1/2 FH Phillips Screw | Metal | 40 | n/a | 10ND | |
| *Painted for shipping & display only; grate will form iron-oxide patina (see page 79). ADA Compliant. | | | | | | |

Dura Slope Metal Decorative Grates

Fits all Dura Slope channels. Available in 8 designs: Weave, Tile, Brick, Diamond, Slot, Kiara, Via and Ville. Ductile iron material, rated Class D and ADA compliant.

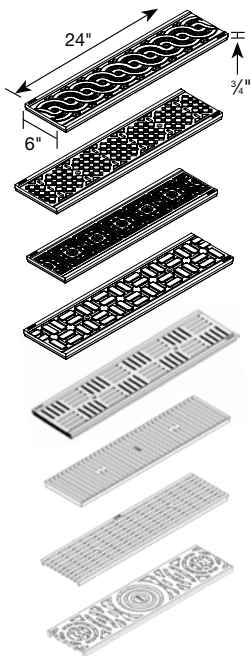

| Part No. | Description | Color | Pkg. Qty. | Wt. Ea. (lbs.) | Product Class | Specifications |
|--|-----------------|--------------|-----------|----------------|---------------|---|
| DS-601 | Weave Pattern | Raw Iron | 1 | 14.50 | 25DS | Decorative grates are made of ductile iron. Weave: open area 6.75 square inches per foot; 20.65 GPM. Diamond: open area 9.55 square inches per foot; 29.21 GPM. Tile: open area 7.95 square inches per foot; 24.32 GPM. Brick: open area 11.35 square inches per foot; 34.725 GPM. Deco slot: open area 16.75 square inches per foot; 51.24 GPM. |
| DS-602 | Diamond Pattern | Raw Iron | 1 | 14.30 | 25DS | |
| DS-603 | Tile Pattern | Raw Iron | 1 | 14.70 | 25DS | |
| DS-604 | Brick Pattern | Raw Iron | 1 | 14.30 | 25DS | |
| DS-609 | Deco Slot | Raw Iron | 1 | 14.50 | 25DS | |
| DS-610-KIARO | Kiara Slot | Ductile Iron | 120 | 14.99 | 25DS | |
| DS-611-VIA | Via Slot | Ductile Iron | 120 | 10.36 | 25DS | |
| DS-612-VILLE | Ville Pattern | Ductile Iron | 120 | 11.68 | 25DS | |
| Use with Dura Slope Drains (page 72), Dura Slope Catch Basins (page 74). Decorative grates are made of ductile iron. Uncoated raw iron will develop a rust patina over time. Additional powder-coat colors available: Black (K), White (W), Silver (S), Bronze (Z), Green (G), Blue (B), Orange (O), Gray (Y), Brown (N). MTO 6-7 week lead time. (see page 79). ADA Compliant/Heelproof. Must be used with DS-200H to achieve Class D Load Rating. | | | | | | |

GRATES: STANDARD, DECORATIVE & METAL

Round Grates

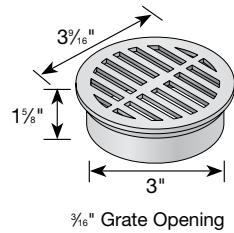

| Part No. | Description | Color | Pkg. Qty. | Wt. Ea. lbs. | Product Class | Specifications |
|----------|----------------|--|-----------|--------------|---------------|--|
| 14 | 3" Round Grate | Black | 40 | 0.13 | 10ND | 3" Round Structural Foam Polyolefin Grate with UV inhibitor. Open surface area 2.60 square inches. 7.95 GPM. |
| 15 | 3" Round Grate | Gray | 40 | 0.13 | 10ND | |
| 16 | 3" Round Grate | Green | 40 | 0.13 | 10ND | |
| 16P | 3" Round Grate | Purple | 40 | 0.13 | 10ND | |
| 16S | 3" Round Grate | Sand | 40 | 0.13 | 10ND | |
| | | Fits 3" Sewer and Drain Pipe & Fittings, 3" Corrugated Pipe, and 3" Triple Wall Pipe. (see page 79). ADA Compliant/Heel-proof. | | | | |

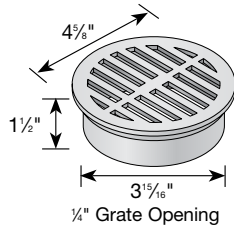

| Part No. | Description | Color | Pkg. Qty. | Wt. Ea. lbs. | Product Class | Specifications |
|----------|----------------|--|-----------|--------------|---------------|---|
| 11 | 4" Round Grate | Black | 25 | 0.17 | 10ND | 4" Round Structural Foam Polyolefin Grate with UV inhibitor. Open surface area 3.85 square inches. 11.78 GPM. |
| 12 | 4" Round Grate | Gray | 25 | 0.17 | 10ND | |
| 13 | 4" Round Grate | Green | 25 | 0.17 | 10ND | |
| 13P | 4" Round Grate | Purple | 25 | 0.17 | 10ND | |
| 13S | 4" Round Grate | Sand | 25 | 0.17 | 10ND | |
| | | Fits 4" Sewer and Drain Pipe & Fittings, 4" Corrugated Pipe, and 4" Triple Wall Pipe. (see page 79). ADA Compliant/Heel-proof. | | | | |

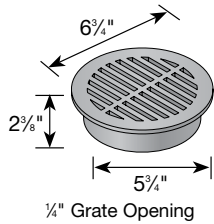

| Part No. | Description | Color | Pkg. Qty. | Wt. Ea. lbs. | Product Class | Specifications |
|----------|----------------|---|-----------|--------------|---------------|---|
| 40 | 6" Round Grate | Black | 10 | 0.49 | 10ND | 6" Round Structural Foam Polyolefin Grate with UV inhibitor. Open surface area 9.10 square inches. 27.84 GPM. |
| 50 | 6" Round Grate | Green | 10 | 0.49 | 10ND | |
| 60 | 6" Round Grate | Gray | 10 | 0.49 | 10ND | |
| 60S | 6" Round Grate | Sand | 10 | 0.49 | 10ND | |
| | | Fits Spee-D® Basin, 6" Sewer and Drain Pipe & Fittings and 6" Corrugated Pipe. (see page 79). ADA Compliant/Heel-proof. | | | | |

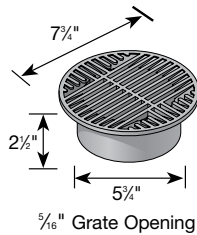



| Part No. | Description | Color | Pkg. Qty. | Wt. Ea. lbs. | Product Class | Specifications |
|----------|----------------|--|-----------|--------------|---------------|--|
| 10 | 8" Round Grate | Black | 10 | 0.60 | 10ND | 8" Round Structural Foam Polyolefin Grate with UV inhibitor. Open surface area 11.50 square inches. 35.18 GPM. |
| 20 | 8" Round Grate | Green | 10 | 0.60 | 10ND | |
| 30 | 8" Round Grate | Gray | 10 | 0.60 | 10ND | |
| 30S | 8" Round Grate | Sand | 10 | 0.60 | 10ND | |
| | | Fits Spee-D® Basin, 6" Sewer and Drain Pipe & Fittings and 6" Corrugated Pipe. (see page 79). ADA Compliant. | | | | |

GRATES: STANDARD, DECORATIVE & METAL

Round Grates (continued)

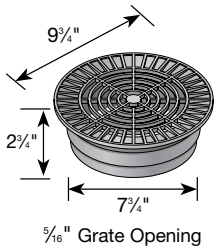
DRAINAGE



| Part No. | Description | Color | Pkg. Qty. | Wt. Ea. lbs. | Product Class | Specifications |
|---|---|-------|-----------|--------------|---------------|---|
| 1040 | 10" Round Grate | Black | 10 | 1.01 | 10ND | 10" Round Structural Foam Polyolefin Grate with UV inhibitor. Open surface area 21.57 square inches. 65.99 GPM. |
| 1050 | 10" Round Grate | Green | 10 | 1.01 | 10ND | |
| 1060 | 10" Round Grate | Gray | 10 | 1.01 | 10ND | |
| 1060S | 10" Round Grate | Sand | 10 | 1.01 | 10ND | |
|  | Fits 8" Sewer and Drain Pipe & Fittings, 8" Corrugated Pipe. (see page 79). ADA Compliant. | | | | | |

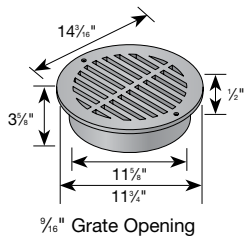

| Part No. | Description | Color | Pkg. Qty. | Wt. Ea. lbs. | Product Class | Specifications |
|---|--|-------|-----------|--------------|---------------|--|
| 1240 | 12" Round Grate | Black | 6 | 2.44 | 10ND | 12" Round Structural Foam Polyolefin Grate with UV inhibitor. Open surface area 46.00 square inches. 140.72 GPM. |
| 1250 | 12" Round Grate | Green | 6 | 2.44 | 10ND | |
| 1260 | 12" Round Grate | Gray | 6 | 2.44 | 10ND | |
|  | Fits 12" Sewer and Drain Pipe, 12" Corrugated Pipe. (see page 79) | | | | | |

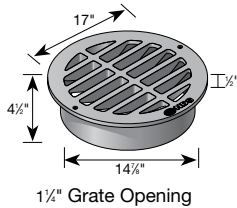

| Part No. | Description | Color | Pkg. Qty. | Wt. Ea. lbs. | Product Class | Specifications |
|---|--|-------|-----------|--------------|---------------|--|
| 1511 | 15" Round Grate | Black | 6 | 6.89 | 10ND | 15" Round Structural Foam Polyolefin Grate with UV inhibitor. Open surface area 85.60 square inches. 261.86 GPM. |
| 1512 | 15" Round Grate | Green | 6 | 6.89 | 10ND | |
|  | Fits 15" Sewer and Drain Fittings, 15" Corrugated Pipe. (see page 79) | | | | | |

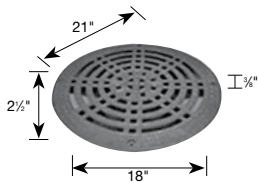

| Part No. | Description | Color | Pkg. Qty. | Wt. Ea. lbs. | Product Class | Specifications |
|---|--|-------|-----------|--------------|---------------|---|
| 1801SDG | 18" Round Grate | Green | 1 | 7.50 | 28ND | Round Polypropylene Grate. Open surface area 75.55 square inches. 231.12 GPM. Includes lag bolts. |
|  | Fits 18" Sewer and Drain Fittings, 18" Corrugated Pipe, includes Lag Bolts. (see page 79) | | | | | |

GRATES: STANDARD, DECORATIVE & METAL

Atrium Grates

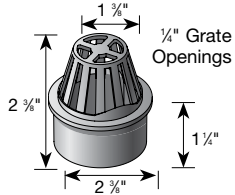

| Part No. | Description | Color | Pkg. Qty. | Wt. Ea. lbs. | Product Class | Specifications |
|-------------------------------|-----------------|-------|-----------|--------------|---------------|---|
| 270 | 2" Atrium Grate | Gray | 20 | 0.10 | 10ND | Flat-Top PVC Atrium Grate with UV inhibitor. Open surface area 4.00 square inches. 12.24 GPM. |
| Fits 2" Schedule 40 Fittings. | | | | | | |

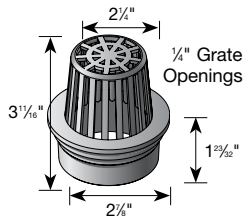

| Part No. | Description | Color | Pkg. Qty. | Wt. Ea. lbs. | Product Class | Specifications |
|---|-----------------|-------|-----------|--------------|---------------|--|
| 70 | 3" Atrium Grate | Green | 20 | 0.16 | 10ND | Flat-Top Structural Foam Polyolefin Atrium Grate with UV inhibitor. Open surface area 9.40 square inches. 28.76 GPM. |
| 72 | 3" Atrium Grate | Gray | 20 | 0.16 | 10ND | |
| 74 | 3" Atrium Grate | Black | 20 | 0.16 | 10ND | |
| 74S | 3" Atrium Grate | Sand | 20 | 0.16 | 10ND | |
| Fits 3" Sewer and Drain Pipe & Fittings, 3" Corrugated Pipe, and 3" Triple Wall Pipe. | | | | | | |

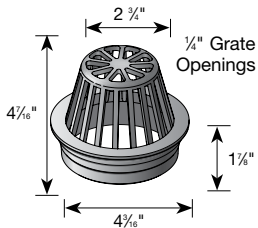

| Part No. | Description | Color | Pkg. Qty. | Wt. Ea. lbs. | Product Class | Specifications |
|---|-----------------|-------|-----------|--------------|---------------|---|
| 75 | 4" Atrium Grate | Green | 20 | 0.21 | 10ND | Flat-Top Structural Foam Polyolefin Atrium Grate with UV inhibitor. Open surface area 17.00 square inches. 52.01 GPM. |
| 76 | 4" Atrium Grate | Gray | 20 | 0.21 | 10ND | |
| 78 | 4" Atrium Grate | Black | 20 | 0.21 | 10ND | |
| 78S | 4" Atrium Grate | Sand | 20 | 0.21 | 10ND | |
| Fits 4" Sewer and Drain Pipe & Fittings, 4" Corrugated Pipe, and 4" Triple Wall Pipe. | | | | | | |

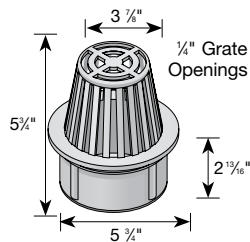



| Part No. | Description | Color | Pkg. Qty. | Wt. Ea. lbs. | Product Class | Specifications |
|---|-----------------|-------|-----------|--------------|---------------|---|
| 80 | 6" Atrium Grate | Green | 10 | 0.62 | 10ND | Flat-Top Structural Foam Polyolefin Atrium Grate with UV inhibitor. Open surface area 28.40 square inches. 86.88 GPM. |
| 81 | 6" Atrium Grate | Gray | 10 | 0.62 | 10ND | |
| 90 | 6" Atrium Grate | Black | 10 | 0.62 | 10ND | |
| 90S | 6" Atrium Grate | Sand | 10 | 0.62 | 10ND | |
| Fits Spee-D® Basin, 6" Sewer and Drain Pipe & Fittings, 6" Corrugated Pipe. | | | | | | |

GRATES: STANDARD, DECORATIVE & METAL

Square Grates

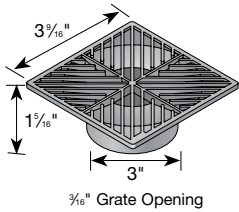
DRAINAGE



| Part No. | Description | Color | Pkg. Qty. | Wt. Ea. lbs. | Product Class | Specifications |
|--|-----------------|-------|-----------|--------------|---------------|---|
| 1 | 4" Square Grate | Green | 40 | 0.11 | 10ND | 4" Square Structural Foam Polyolefin Grate with diagonally converging pattern with UV inhibitor. Open surface area 3.45 square inches. 10.55 GPM. |
| 2 | 4" Square Grate | Black | 40 | 0.11 | 10ND | |
| 3 | 4" Square Grate | Gray | 40 | 0.11 | 10ND | |
|  Fits 3" Sewer and Drain Pipe & Fittings, 3" Corrugated Pipe, and 3" Triple Wall Pipe. (see page 79). ADA Compliant/Heel-proof. | | | | | | |

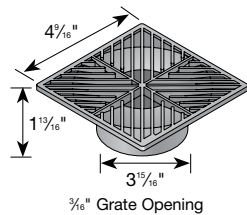

| Part No. | Description | Color | Pkg. Qty. | Wt. Ea. lbs. | Product Class | Specifications |
|--|-----------------|-------|-----------|--------------|---------------|---|
| 7 | 5" Square Grate | Green | 25 | 0.20 | 10ND | 5" Square Structural Foam Polyolefin Grate with diagonally converging pattern with UV inhibitor. Open surface area 4.25 square inches. 13.00 GPM. |
| 8 | 5" Square Grate | Black | 25 | 0.20 | 10ND | |
| 9 | 5" Square Grate | Gray | 25 | 0.20 | 10ND | |
|  Fits 4" Sewer and Drain Pipe & Fittings, 4" Corrugated Pipe, and 4" Triple Wall Pipe. (see page 79). ADA Compliant/Heel-proof. | | | | | | |

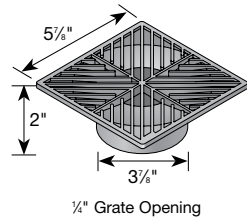

| Part No. | Description | Color | Pkg. Qty. | Wt. Ea. lbs. | Product Class | Specifications |
|--|-----------------|-------|-----------|--------------|---------------|--|
| 4 | 6" Square Grate | Black | 10 | 0.40 | 10ND | 6" Square Structural Foam Polyolefin Grate with diagonally converging pattern with UV inhibitor. Open surface area 10.40 square inches. 31.81 GPM. |
| 5 | 6" Square Grate | Green | 10 | 0.40 | 10ND | |
| 6 | 6" Square Grate | Gray | 10 | 0.40 | 10ND | |
| 06S | 6" Square Grate | Sand | 10 | 0.40 | 10ND | |
|  Fits 3" or 4" Sewer and Drain Pipe & Fittings, 3" or 4" Corrugated Pipe, and 3" or 4" Triple Wall Pipe. (see page 79). ADA Compliant/Heel-proof. | | | | | | |

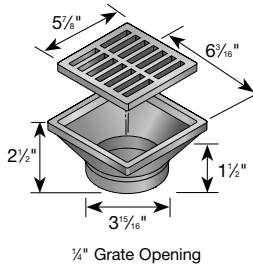

| Part No. | Description | Color | Pkg. Qty. | Wt. Ea. lbs. | Product Class | Specifications |
|--|-------------------------------------|-------|-----------|--------------|---------------|--|
| 640 | 6" x 6" x 4" Square Grate & Adapter | Black | 8 | 0.83 | 10ND | 6"x6" Low-Profile Adapter and Structural Foam Polyolefin Removable Grate with UV inhibitor and stainless steel screws. Open surface area 14.44 square inches. 44.17 GPM. |
| 641 | 6" x 6" x 4" Square Grate & Adapter | Green | 8 | 0.83 | 10ND | |
| 642 | 6" x 6" x 4" Square Grate & Adapter | Gray | 8 | 0.83 | 10ND | |
|  Fits 3" or 4" Sewer and Drain Pipe & Fittings, 3" or 4" Corrugated Pipe, and 3" or 4" Triple Wall Pipe. (see page 79). ADA Compliant/Heel-proof. | | | | | | |

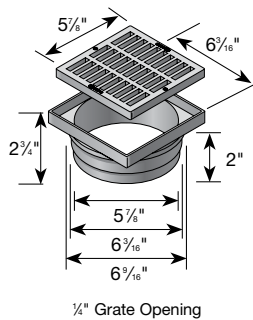

| Part No. | Description | Color | Pkg. Qty. | Wt. Ea. lbs. | Product Class | Specifications |
|--|-------------------------------------|-------|-----------|--------------|---------------|--|
| 637 | 6" x 6" x 6" Square Grate & Adapter | Black | 8 | 0.88 | 10ND | 6"x6" Low-Profile Adapter and Structural Foam Polyolefin Removable Grate with UV inhibitor and stainless steel screws. Open surface area 14.44 square inches. 44.17 GPM. |
|  Fits Spee-D® Basin, 6" Sewer and Drain Pipe & Fittings. (see page 79). ADA Compliant/Heel-proof. | | | | | | |

GRATES: STANDARD, DECORATIVE & METAL

Square Grates (continued)

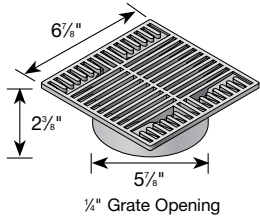

| Part No. | Description | Color | Pkg. Qty. | Wt. Ea. lbs. | Product Class | Specifications |
|---|-----------------|-------|-----------|--------------|---------------|---|
| 771 | 7" Square Grate | Black | 10 | 0.65 | 10ND | 7" Square Structural Foam Polyolefin Grate with UV inhibitor. Open surface area 13.60 square inches. 41.60 GPM. |
| 772 | 7" Square Grate | Green | 10 | 0.65 | 10ND | |
| 773 | 7" Square Grate | Gray | 10 | 0.65 | 10ND | |
| 773S | 7" Square Grate | Sand | 10 | 0.65 | 10ND | |
|  Fits Spee-D® Basin, 6" Sewer and Drain Pipe & Fittings, 6" Corrugated Pipe. (see page 79). ADA Compliant/Heel-proof. | | | | | | |

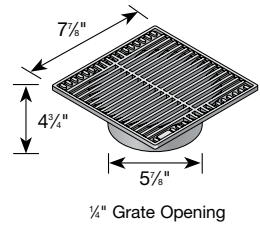

| Part No. | Description | Color | Pkg. Qty. | Wt. Ea. lbs. | Product Class | Specifications |
|--|-----------------|-------|-----------|--------------|---------------|---|
| 881 | 8" Square Grate | Black | 10 | 0.79 | 10ND | 8" Square Structural Foam Polyolefin Grate with UV inhibitor. Open surface area 17.16 square inches. 52.49 GPM. |
| 882 | 8" Square Grate | Green | 10 | 0.79 | 10ND | |
| 883 | 8" Square Grate | Gray | 10 | 0.79 | 10ND | |
| 883S | 8" Square Grate | Sand | 10 | 0.79 | 10ND | |
|  Fits Spee-D® Basin, 6" Sewer and Drain Pipe & Fittings, 6" Corrugated Pipe and DWV Pipe. (see page 79). ADA Compliant/Heel-proof. | | | | | | |

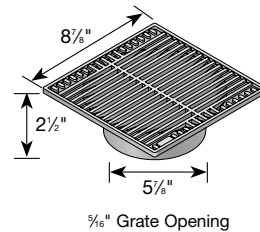

| Part No. | Description | Color | Pkg. Qty. | Wt. Ea. lbs. | Product Class | Specifications |
|--|-----------------|-------|-----------|--------------|---------------|---|
| 950 | 9" Square Grate | Green | 10 | 1.11 | 10ND | 9" Square Structural Foam Polyolefin Grate with UV inhibitor. Open surface area 28.40 square inches. 86.88 GPM. |
| 960 | 9" Square Grate | Gray | 10 | 1.11 | 10ND | |
| 970 | 9" Square Grate | Black | 10 | 1.11 | 10ND | |
| 970S | 9" Square Grate | Sand | 10 | 1.11 | 10ND | |
|  Fits Spee-D® Basin, 6" Sewer and Drain Pipe & Fittings, 6" Corrugated Pipe. (see page 79). ADA Compliant. | | | | | | |

GRATES: STANDARD, DECORATIVE & METAL

Duracast™ In-Line Grates

DRAINAGE

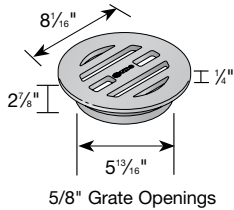

| Part No. | Description | Color | Pkg. Qty. | Wt. Ea. (lbs.) | Product Class | Specifications |
|---|----------------|--------|-----------|----------------|---------------|--|
| D6 | 6" Round Grate | Black* | 1 | 7.30 | 10ND | 6" Round Heavy-Duty Ductile Grate with Black Paint. Open surface area 7.05 square inches. 21.57 GPM. H-20 load rating. |
|  <p>Fits 6" Corrugated and Sewer and Drain Pipe. D6 is not a custom grate and qualifies for normal NDS freight terms. Fits SPEE-D® Basin. *Painted for shipping & display only; grate will form iron-oxide patina (see page 79).</p> | | | | | | |

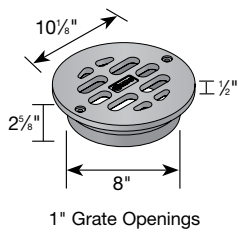

| Part No. | Description | Color | Pkg. Qty. | Wt. Ea. (lbs.) | Product Class | Specifications |
|---|----------------|--------|-----------|----------------|---------------|---|
| D8 | 8" Round Grate | Black* | 1 | 14.59 | 10ND | 8" Round Heavy-Duty Ductile Iron Grate with Black Paint. Open surface area 13.98 square inches. 42.77 GPM. Bolt holes for added security. H-20 load rating. |
|  <p>Fits 8" Corrugated and Sewer and Drain Pipe. D8 is not a custom grate and qualifies for normal NDS freight terms. *Painted for shipping & display only; grate will form iron-oxide patina (see page 79).</p> | | | | | | |

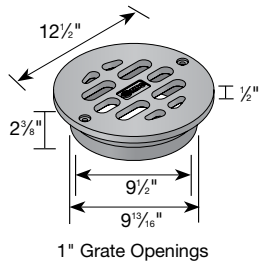

| Part No. | Description | Color | Pkg. Qty. | Wt. Ea. (lbs.) | Product Class | Specifications |
|---|-----------------|--------|-----------|----------------|---------------|--|
| D10 | 10" Round Grate | Black* | 1 | 20.60 | 10ND | 10" Round Heavy-Duty Ductile Iron Grate with Black Paint. Open surface area 26.82 square inches. 82.05 GPM. Bolt holes for added security. H-20 load rating. |
|  <p>Fits 10" Corrugated and Sewer and Drain Pipe. D10 is not a custom grate and qualifies for normal NDS freight terms. *Painted for shipping & display only; grate will form iron-oxide patina (see page 79).</p> | | | | | | |

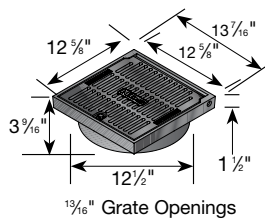

| Part No. | Description | Color | Pkg. Qty. | Wt. Ea. (lbs.) | Product Class | Specifications |
|---|---|--------|-----------|----------------|---------------|--|
| D12H-W0 | 12" Square Hinged Cast Iron Grate without Adapter | Black* | 1 | 48.00 | 10ND | H-20 load rating. Open surface area 48.30 square inches. 147.76 GPM. |
| D12 | 12" Round Grate | Black* | 1 | 16.00 | 10ND | H-20 load rating. Open surface area 55.16 square inches. 169.74 GPM. |
|  <p>Fits 12" Corrugated and Sewer and Drain Pipe. *Painted for shipping & display only; grate will form iron-oxide patina (see page 79).</p> | | | | | | |

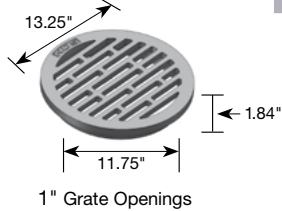

DRAINAGE PRODUCTS INDEX

| Part No. | Page | Part No. | Page | Part No. | Page | Part No. | Page | Part No. | Page |
|------------|--------|-----------|--------------------|-------------|--------|-------------|--------|--------------|--------|
| 1 | 48 | 250 | 26 | 900GRKIT | 27 | 1212S | 30 | 2404 | 34 |
| 2 | 48 | 252 | 44 | 900KITDISP | 27 | 1213 | 31 | 2410 | 34, 35 |
| 3 | 48 | 252CI | 44 | 905PB | 40 | 1215 | 31 | 2411 | 34 |
| 3C05 | 21, 38 | 252GR | 44 | 906PB | 40 | 1216 | 29 | 2412 | 34 |
| 3C06 | 21, 38 | 252GY | 44 | 907PC | 40 | 1217 | 29 | 2413 | 34 |
| 3P02 | 38 | 252S | 44 | 908PC | 40 | 1218 | 30, 42 | 2415 | 34 |
| 4 | 48 | 253 | 44 | 909B | 40 | 1218CI | 30, 42 | 2418 | 34 |
| 4C06 | 21, 38 | 253CI | 44 | 910B | 40 | 1218GR | 30, 42 | D6 | 50 |
| 4C07 | 21, 38 | 253GR | 44 | 913 | 28 | 1218GY | 30, 42 | D8 | 50 |
| 4P02 | 38 | 253GY | 44 | 913B | 41 | 1218S | 30, 42 | D10 | 50 |
| 5 | 48 | 253S | 44 | 914PB | 41 | 1220 | 31 | D12 | 50 |
| 6 | 48 | 270 | 47 | 915 | 28 | 1221 | 31 | D12H-WO | 50 |
| 6C06 | 21, 38 | 300 | 26 | 915SC | 40 | 1222 | 31 | DS-601 | 44 |
| 6C07 | 21, 38 | 321 | 36 | 916 | 27 | 1224 | 31, 42 | DS-602 | 44 |
| 6P02 | 38 | 350 | 26 | 917SC | 40 | 1224CI | 31, 42 | DS-603 | 44 |
| 06S | 48 | 351 | 38 | 918B | 40 | 1224GR | 31, 42 | DS-604 | 44 |
| 7 | 48 | 420 | 36 | 919PB | 40 | 1224GY | 31, 42 | DS-609 | 44 |
| 8 | 48 | 421 | 36 | 920B | 41 | 1224S | 31, 42 | DS-610-KIARO | 44 |
| 9 | 48 | 451 | 38 | 921B | 41 | 1225 | 29 | DS-611-VIA | 44 |
| 10 | 45 | 552B | 40 | 922PB | 41 | 1230 | 31 | DS-612-VILLE | 44 |
| 11 | 45 | 553PB | 40 | 923PB | 41 | 1230ATBLKIT | 31 | EZ-0701A | 21 |
| 12 | 45 | 554 | 43 | 930 | 28 | 1230B | 30, 41 | EZ-0701F | 21 |
| 13 | 45 | 554CI | 43 | 930B | 28, 41 | 1230GRKIT | 31 | EZ-1001A | 21 |
| 13P | 45 | 554GR | 43 | 930GRKIT | 28 | 1240 | 46 | EZ-1001F | 21 |
| 13S | 45 | 554GY | 43 | 931 | 28 | 1242 | 35 | EZ-1501A | 21 |
| 14 | 45 | 554S | 43 | 932 | 28 | 1243 | 35 | EZ-1501F | 21 |
| 15 | 45 | 555 | 43 | 933 | 28 | 1245 | 35 | FWAS24CWH | 25 |
| 16 | 45 | 555CI | 43 | 950 | 49 | 1250 | 46 | FWAS24WH | 25 |
| 16P | 45 | 555GR | 43 | 960 | 49 | 1260 | 46 | FWBP24 | 25 |
| 16S | 45 | 555GY | 43 | 970 | 49 | 1266 | 35 | FWFF67 | 25 |
| 20 | 45 | 555S | 43 | 970S | 49 | 1280 | 30 | FWSD69 | 25 |
| 30 | 45 | 620 | 37 | 980 | 27 | 1290 | 30 | FWSPS3WH | 25 |
| 30S | 45 | 624 | 37 | 981 | 27 | 1511 | 46 | SC-1820-C-0 | 23 |
| 40 | 45 | 625 | 37 | 990 | 27 | 1512 | 46 | SC-1820-E-0 | 23 |
| 50 | 45 | 629 | 30, 31, 42, 43, 44 | 991 | 27 | 1800 | 32 | SC-1820-M-0 | 23 |
| 60 | 45 | 637 | 48 | 999 | 27 | 1801SDG | 46 | SC-1820-S-0 | 23 |
| 60S | 45 | 640 | 48 | 999S | 27 | 1804 | 32 | SC-2412P | 23 |
| 70 | 47 | 641 | 48 | 1040 | 46 | 1810 | 32 | SC-3020P | 23 |
| 72 | 47 | 642 | 48 | 1050 | 46 | 1811 | 32 | SC-3475-C-0 | 23 |
| 74 | 47 | 651 | 38 | 1060 | 46 | 1812 | 32 | SC-3475-E-0 | 23 |
| 74S | 47 | 771 | 49 | 1060S | 46 | 1813 | 32 | SC-3475-M-0 | 23 |
| 75 | 47 | 772 | 49 | 1200 | 29 | 1815 | 33 | SC-3475-S-0 | 23 |
| 76 | 47 | 773 | 49 | 1200BLKIT | 29 | 1816 | 32 | SC-3475W-C-0 | 23 |
| 78 | 47 | 773S | 49 | 1200DSG | 30 | 1830 | 33 | SC-3475W-E-0 | 23 |
| 78B | 41 | 829 | 44 | 1200FF | 29 | 1840 | 33 | SC-3475W-M-0 | 23 |
| 78S | 47 | 839 | 30, 31, 42 | 1200GRKIT | 29 | 1881 | 32 | SC-3475W-S-0 | 23 |
| 80 | 47 | 846 | 43 | 1200KITDISP | 29 | 1882 | 32 | SC-44105-C-0 | 23 |
| 81 | 47 | 881 | 49 | 1200NGB | 29 | 1882BLKIT | 32 | SC-44105-E-0 | 23 |
| 90 | 47 | 882 | 49 | 1200NGBKIT | 29 | 1882GRKIT | 32 | SC-44105-M-0 | 23 |
| 90B | 41 | 883 | 49 | 1203 | 29 | 1884 | 32 | SC-44105-S-0 | 23 |
| 90S | 47 | 883S | 49 | 1204 | 29 | 1888 | 35 | SC-FL-10 | 23 |
| 101 | 26 | 900 | 27 | 1206 | 35 | 1889 | 35 | SC-NWFF-500 | 23 |
| 101ATBLKIT | 26 | 900-4 | 27 | 1207 | 29 | 1890 | 32 | SC-ST | 23 |
| 101GRKIT | 26 | 900BLKIT | 27 | 1208 | 29 | 1891 | 32 | SC-WFF-75 | 23 |
| 101R | 26 | 900DSG | 27 | 1210 | 30 | 2400 | 34 | | |
| 101SQGRKIT | 26 | 900DSGKIT | 27 | 1211 | 30 | 2400BLKIT | 34 | | |
| 201 | 26 | 900FF | 27 | 1212 | 30 | 2400GRKIT | 34 | | |









CHANNEL & TRENCH DRAINS

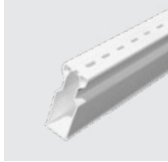

CHANNEL AND TRENCH DRAINS

Channel & Trench Drain Product Line-up

NDS Channel and Trench Drain Systems provide durable and proven solutions for sheet-flow drainage in applications ranging from light foot traffic to heavy vehicular traffic.

| PROFILE SERIES | | | | | | |
|---|---|---|---|--|---|---|
| Micro Channel™ | Slim Channel | Mini Channel™ | Spee-D® Channel | Pro Series Channel™ | Dura Slope™ | FILCOTEN® by NDS® |
|  |  |  |  |  |  |  |
| Pools, Spas, Patios | Patios, Pools, Spas, Walkways & Paver Landscapes | Pools, Patios, Tennis Courts | Pools, Pool Decks, Driveways | 3", 5", 8" and 12", Patios, Driveways, Sports Fields | Driveways, Parking Lots, Courtyards | 4", 8" and 12", Fiber-reinforced Concrete |

CHANNEL & TRENCH DRAINS

Durable

Designed for maximum durability, drainage, and performance NDS Channel and Trench Drains are a proven alternative to traditional concrete drains. UV inhibitors in the plastic grate, channel and component parts prevent fading and cracking from the sun. All plastic grate and channel components are **chemically resistant, rustproof, and maintenance-free**.

Simple

NDS Plastic Channel and Trench Drains are light weight and easy to install. Grates are removable for easy clean out and replacement. Grates may be held in place with screws or hold-down clips. A complete line of accessories is available for each Channel and Trench Drain System. Our "Profile Series" of channel drains connect like PVC pipe. Our modular "Pro Series" injection-molded channel has mechanical interlocking joints. Our "Dura Slope" Trench Drain System is injection-molded, modular, has mechanical interlocking joints and a built-in slope. All NDS Channel and Trench Drain Systems easily connect to sewer and drain pipes and fittings or Sch. 40 pipes and fittings.

Versatile

To blend with surrounding surfaces, our plastic Channel Grates are available in six colors, some with decoartive options, as well as solid brass for the Mini Channel. Cast iron and rolled steel grates are available for the Dura Slope and Pro Series Channel. A ductile iron frame is also available. NDS Channel and Trench Drains also offer a choice of outletting locations; bottom, end and side options available.

Efficient

Channel and Trench Drains eliminate the need for grading a deck surface to a low area. Instead, the deck is gradually sloped in one direction or plane, and the channel drain acts as a perimeter drain at the edge of the slope to receive sheet-flow runoff. Channel and Trench Drain Systems provide more overall open surface area than conventional area grates.

Recommended Applications











- Driveways
- Warehouses
- Washdown Areas
- Loading Docks
- Tennis Courts
- Patios
- Nurseries & Greenhouses
- Plazas
- Parking Lots
- Swimming Pools & Spas
- Running Tracks
- Courtyards
- Sidewalks
- Sports Facilities
- Manufacturing Facilities
- Landings

See capacity recommendations for channel & trench drains, pages 79 & 87.

CHANNEL AND TRENCH DRAINS

Application Matrix – Choosing the Right Product

CHANNEL & TRENCH DRAINS

| Top Applications | | Micro Channel™ | Slim Channel | Mini Channel™ | Spee-D® Channel | 3" Pro Series Channel™ | 5" Pro Series Channel™ | 8" Pro Series Channel™ | 12" Pro Series Channel™ | Dura Slope™ | FILCOTEN® by NDS® |
|---|------------------------------------|----------------|--------------|---------------|-----------------|------------------------|------------------------|------------------------|-------------------------|-------------|-------------------|
|  | Pool Decks & Patios | ● | ● | ● | ● | ● | ● | ● | ● | ● | ● |
|  | Sidewalks/Walkways | ● | ● | ● | ● | ● | ● | ● | ● | ● | ● |
|  | Plaza / Courtyard | | ● | ● | ● | ● | ● | ● | ● | ● | ● |
|  | Residential Driveway | | | ● | ● | ● | ● | ● | ● | ● | ● |
|  | Sports Facilities | | | | | | ● | ● | ● | ● | ● |
|  | Loading Dock | | | | | | ● | ● | ● | ● | ● |
|  | MFG Facilities | | | | | | ● | ● | ● | ● | ● |
|  | Washdown Areas | | | | | | ● | ● | ● | ● | ● |
|  | Parking Lots | | | | | | ● | ● | ● | ● | ● |
|  | Warehouse (hard-tire forklifts) | | | | | | | | | ● | ● |

PROFILE CHANNEL DRAINS

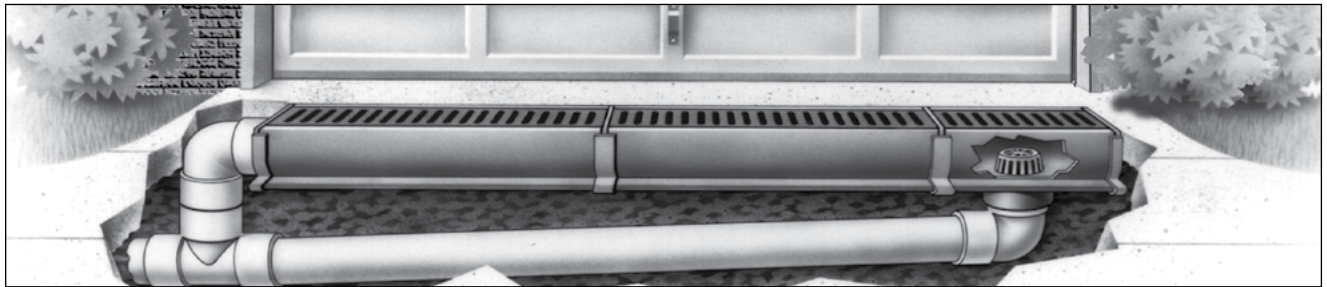

CHANNEL & TRENCH DRAINS

Details

Unique patented flying buttress design provides load-bearing support from both sides as well as underneath.

Available in three sizes: Spee-D® for driveways, large decks and commercial areas; Mini for landscapes, pools or decks; and Micro for residential pools and spas.

Unique flanges on the bottom of the channel provide an anchoring lip for straight installation and prevents floating.

Materials and Standards

- Only channels made of PVC can be cut to any length and solvent-welded like PVC pipe.
- rates available in six colors with decorative options – see individual products for details.
- Mini Channel Grate also available in solid brass.
- Channel system offers choice of bottom, end or side outlets.
- Concrete is not required under some channels for light vehicular applications. Standards vary per product.

Mini and Spee-D® Channel System Components

1. Channel
2. Grate
3. Coupling
4. End Cap or End Outlet
5. Channel Bottom Outlet
6. Sewer and Drain Fitting
7. Drain Pipe

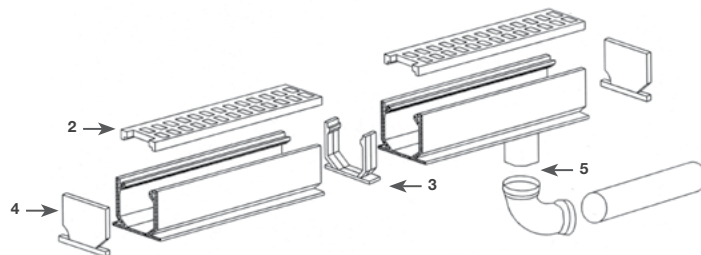

Slim Channel System Components

1. Robust extruded PVC channel available in 6-ft and 9-ft lengths
2. Anchor clips help secure the channel to a prepared base or suspend it with rebar
3. Attractive grate designs enhance any landscape and have high flow capacity for superior drainage
4. Couplers provide a secure channel-to-channel connection
5. End caps have a convenient KNOCKOUT for outletting to 1.5-in SCH 40 pipe
6. Convenient bottom outlets can be installed anywhere along the channel for 1.5-in SCH 40 pipe connections

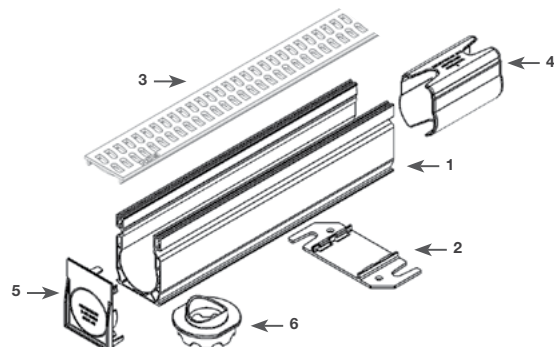

PROFILE CHANNEL DRAINS

Micro Channel™ Drains

Excellent performance at lowest possible cost. Designed for residential applications including swimming pools, spas and patios. Unique design features grate openings parallel to channel length and recessed grate for strength and effective runoff capture.

CHANNEL & TRENCH DRAINS

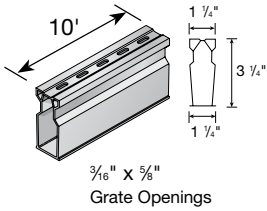

| Part No. | Description | Color | Pkg. Qty. | Wt. Ea. (lbs.) | Product Class | Specifications |
|---|--|-------|-----------|----------------|---------------|---|
| 8001 | 10' Long Micro Channel | White | 100 ft. | 5.00 | 25PF | 10 ft. Micro Channel with Recessed Reinforced Grate Area, Parallel Drain Slots with UV inhibitor. Open surface area 1.00 square inch per linear foot. 3.06 GPM per foot. PVC. |
| 8002 | 10' Long Micro Channel | Sand | 100 ft. | 5.00 | 25PF | |
| 8003 | 10' Long Micro Channel | Gray | 100 ft. | 5.00 | 25PF | |
|  | Includes 1 coupling. (see page 79). ADA Compliant/Heel-proof. | | | | | |

Micro Accessories

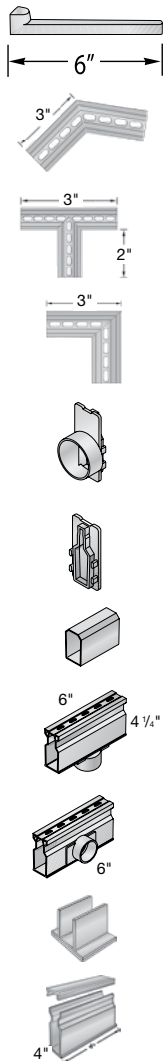

| Part No. | Description | Color | Pkg. Qty. | Wt. Ea. (lbs.) | Product Class |
|----------|---|-------|-----------|----------------|---------------|
| 230 | 6" Channel Installation Stake | Gray | 24 | 0.04 | 25PF |
| 8301 | Micro Channel 45° Elbow | White | 5 | 0.30 | 25PF |
| 8302 | Micro Channel 45° Elbow | Sand | 5 | 0.30 | 25PF |
| 8303 | Micro Channel 45° Elbow | Gray | 5 | 0.30 | 25PF |
| 8371 | Micro Channel Tee | White | 5 | 0.40 | 25PF |
| 8372 | Micro Channel Tee | Sand | 5 | 0.40 | 25PF |
| 8373 | Micro Channel Tee | Gray | 5 | 0.40 | 25PF |
| 8381 | Micro Channel 90° Elbow | White | 5 | 0.40 | 25PF |
| 8382 | Micro Channel 90° Elbow | Sand | 5 | 0.40 | 25PF |
| 8383 | Micro Channel 90° Elbow | Gray | 5 | 0.40 | 25PF |
| 8461 | Micro 1 1/2" Sch. 40 Spigot End Outlet | White | 10 | 0.10 | 25PF |
| 8462 | Micro 1 1/2" Sch. 40 Spigot End Outlet | Sand | 10 | 0.10 | 25PF |
| 8463 | Micro 1 1/2" Sch. 40 Spigot End Outlet | Gray | 10 | 0.10 | 25PF |
| 8471 | Micro End Plug | White | 20 | 0.05 | 25PF |
| 8472 | Micro End Plug | Sand | 20 | 0.05 | 25PF |
| 8473 | Micro End Plug | Gray | 20 | 0.05 | 25PF |
| 8481 | Micro Channel Couplings only Fits inside channel | White | 20 | 0.10 | 25PF |
| 8501 | Micro 1 1/2" Sch. 40 Spigot Bottom Outlet | White | 10 | 0.35 | 25PF |
| 8502 | Micro 1 1/2" Sch. 40 Spigot Bottom Outlet | Sand | 10 | 0.35 | 25PF |
| 8503 | Micro 1 1/2" Sch. 40 Spigot Bottom Outlet | Gray | 10 | 0.35 | 25PF |
| 8511 | Micro 1 1/2" Sch. 40 Spigot Side Outlet | White | 10 | 0.35 | 25PF |
| 8512 | Micro 1 1/2" Sch. 40 Spigot Side Outlet | Sand | 10 | 0.35 | 25PF |
| 8513 | Micro 1 1/2" Sch. 40 Spigot Side Outlet | Gray | 10 | 0.35 | 25PF |
| 8601 | Micro Hold-Down Clips Use with Channel Stakes to hold channel in place | White | 20 | 0.10 | 25PF |
| 8651 | Micro Channel Cleanout | White | 10 | 0.30 | 25PF |
| 8652 | Micro Channel Cleanout | Sand | 10 | 0.30 | 25PF |
| 8653 | Micro Channel Cleanout | Gray | 10 | 0.30 | 25PF |

PROFILE CHANNEL DRAINS

Slim Channel Drains

Excellent for light duty applications, including residential pools, concrete and paver patios, spas, walkways and paver landscapes.

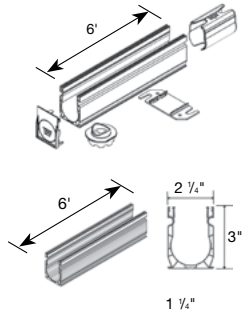

| Part No. | Description | Color | Pkg. Qty. | Wt. Ea. (lbs.) | Product Class | Specifications | |
|---|--|-------|---------------|----------------|---------------|--|--|
| 9206SKIT | 6 ft. Slim Channel Kits with sand plastic grates | Sand | 15 EA (90 LF) | 4.2 | 25PF | 2.25" wide Channel Drain Kits & Assemblies End & bottom outlets fit 1-1/2" Schedule 40 pipe PVC Channel with UV inhibitor See related specifications for 9241, 9242 & 9243 plastic slotted grates | |
| 9206GKIT | 6 ft. Slim Channel Kits with gray plastic grates | Gray | 15 EA (90 LF) | 4.2 | 25PF | | |
| 9209WHITE | 9 ft. Slim Channel & Grate Assembly | White | 10 EA (90 LF) | 5.58 | 25PF | | |
| 9209SAND | 9 ft. Slim Channel & Grate Assembly | Sand | 10 EA (90 LF) | 5.58 | 25PF | | |
| 9209GRAY | 9 ft. Slim Channel & Grate Assembly | Gray | 10 EA (90 LF) | 5.58 | 25PF | | |
| Assemblies include 9 ft. channel and 3 slotted grates | | | | | | | |
| 9206 | 6 ft. Slim Channel | Black | 15 EA (90 LF) | 3.00 | 25PF | | |
| 9209 | 9 ft. Slim Channel | Black | 10 EA (90 LF) | 4.5 | 25PF | | |
|  | (see page 79). | | | | | | |

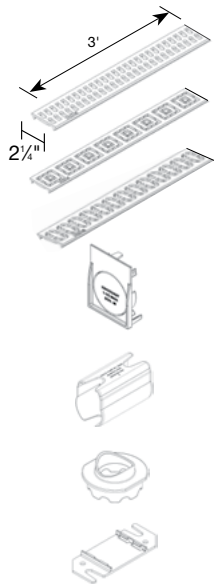

| Part No. | Description | Color | Pkg. Qty. | Wt. Ea. (lbs.) | Product Class | Specifications |
|---|---------------------------------|-------|---------------|----------------|---------------|--|
| 9241 | 3 ft. Slim Channel Grate | White | 30 EA (90 LF) | 0.36 | 25PF | 3 ft polypropylene channel grate with UV inhibitor. Open Surface Area 7.01 square inches per foot. 21.44 GPM per foot. |
| 9242 | 3 ft. Slim Channel Grate | Sand | 30 EA (90 LF) | 0.36 | 25PF | |
| 9243 | 3 ft. Slim Channel Grate | Gray | 30 EA (90 LF) | 0.36 | 25PF | |
| 9251 | 3 ft. Slim Channel Grate Square | White | 30 EA (90 LF) | 0.36 | 25PF | 3 ft Polypropylene Decorative Square Channel Grate with UV inhibitor. Open Surface Area 5.73 square inches per foot. 21.44 GPM per foot. |
| 9252 | 3 ft. Slim Channel Grate Square | Sand | 30 EA (90 LF) | 0.36 | 25PF | |
| 9253 | 3 ft. Slim Channel Grate Square | Gray | 30 EA (90 LF) | 0.36 | 25PF | |
| 9261 | 3 ft. Slim Channel Grate Chain | White | 30 EA (90 LF) | 0.36 | 25PF | 3 ft Polypropylene Decorative Chain Channel Grate with UV inhibitor. Open Surface Area 5.73 square inches per foot. 21.44 GPM per foot. |
| 9262 | 3 ft. Slim Channel Grate Chain | Sand | 30 EA (90 LF) | 0.36 | 25PF | |
| 9263 | 3 ft. Slim Channel Grate Chain | Gray | 30 EA (90 LF) | 0.36 | 25PF | |
|  | (see page 79). | | | | | |

| Part No. | Description | Color | Pkg. Qty. | Wt. Ea. (lbs.) | Product Class | Specifications |
|----------|-----------------------------|-------|-----------|----------------|---------------|--|
| 9247 | Slim Channel End Cap/Outlet | Black | 20 EA | 0.04 | 25PF | End & bottom outlets fit 1-1/2" Schedule 40 pipe |
| 9248 | Slim Channel Coupling | Black | 20 EA | 0.08 | 25PF | |
| 9250 | Slim Channel Bottom Outlet | Black | 10 EA | 0.04 | 25PF | |
| 9270 | Slim Channel Anchor Clip | Black | 20 EA | 0.04 | 25PF | |
| 9301 | Slim Channel Fab 45 | White | 1 EA | 0.29 | 25PF | |
| 9302 | Slim Channel Fab 45 | Sand | 1 EA | 0.29 | 25PF | |
| 9303 | Slim Channel Fab 45 | Gray | 1 EA | 0.29 | 25PF | |
| 9371 | Slim Channel Fab Tee | White | 1 EA | 0.41 | 25PF | |
| 9372 | Slim Channel Fab Tee | Sand | 1 EA | 0.41 | 25PF | |
| 9373 | Slim Channel Fab Tee | Gray | 1 EA | 0.41 | 25PF | |
| 9381 | Slim Channel Fab 90 | White | 1 EA | 0.35 | 25PF | |
| 9382 | Slim Channel Fab 90 | Sand | 1 EA | 0.35 | 25PF | |
| 9383 | Slim Channel Fab 90 | Gray | 1 EA | 0.35 | 25PF | |

CHANNEL & TRENCH DRAINS

PROFILE CHANNEL DRAINS

Mini Channel™ Drains

Excellent for light-duty applications including residential pools, concrete and paver patios, spas and tennis courts.

CHANNEL & TRENCH DRAINS

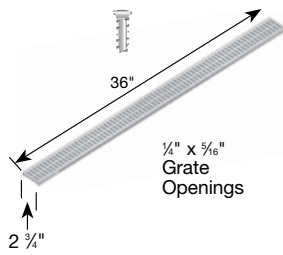

| Part No. | Description | Color | Pkg. Qty. | Wt. Ea. (lbs.) | Product Class | Specifications |
|---|--------------------------------------|-----------|-----------|----------------|---------------|--|
| 529 | Stainless Steel Screws, FH #4 x 5/8" | Steel | 64 | 0.10 | 25PF | 3 ft. Structural Foam Polyolefin Channel Grate with UV inhibitor. Open surface area 9.90 square inches per foot. 30.29 GPM per foot. |
| 540 | 3' Channel Grate | White | 48 ft. | 0.66 | 25PF | |
| 541 | 3' Channel Grate | Gray | 48 ft. | 0.66 | 25PF | |
| 542 | 3' Channel Grate | Green | 48 ft. | 0.66 | 25PF | |
| 543 | 3' Channel Grate | Black | 48 ft. | 0.66 | 25PF | |
| 544 | 3' Channel Grate | Sand | 48 ft. | 0.66 | 25PF | |
| 551 | 3' Channel Grate | Brick Red | 48 ft. | 0.66 | 25PF | |
| Requires 4 screws per Grate. (see page 79). ADA Compliant/Heel-proof. | | | | | | |

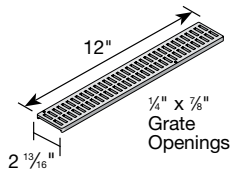

| Part No. | Description | Color | Pkg. Qty. | Wt. Ea. (lbs.) | Product Class | Specifications |
|--|------------------------|----------------|-----------|----------------|---------------|--|
| 552B | 1' Brass Channel Grate | Satin Brass | 12 | 1.25 | 25PF | 1 ft. Mini Channel Solid Brass Grate with brass screws. Open surface area 9.20 square inches per foot. 28.14 GPM per foot. |
| 553PB | 1' Brass Channel Grate | Polished Brass | 12 | 1.25 | 25PF | |
| Fits #500 Mini Channel. (see page 79). ADA Compliant/Heel-proof. | | | | | | |

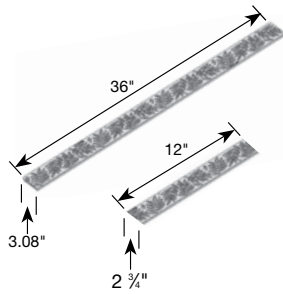

| Part No. | Description | Color | Pkg. Qty. | Wt. Ea. (lbs.) | Product Class | Specifications |
|---|--------------------------------------|--------|-----------|----------------|---------------|--|
| 846 | Stainless Steel Screws, FH #4 x 1" | Steel | 64 | 0.10 | 25PF | 3 ft. Structural Foam Polyolefin botanical pattern Channel Grate with UV inhibitor. Open surface area 5.44 square inches per foot. 16.64 GPM per foot. |
| 554S | 3' Botanical Channel Grate | Sand | 16 | 0.89 | 25PF | |
| 554GR | 3' Botanical Channel Grate | Green | 16 | 0.89 | 25PF | |
| 554GY | 3' Botanical Channel Grate | Gray | 16 | 0.89 | 25PF | |
| 554 | 3' Botanical Channel Grate | Black | 16 | 0.89 | 25PF | |
| 554CI | 1' Botanical Cast Iron Channel Grate | Black* | 1 | 1.82 | 25PF | 1 ft. Mini Channel botanical Cast Iron Channel Grate. Open surface area 5.39 square inches per foot. 16.49 GPM per foot. Class B load rated. |
| Fits #500 Mini Channel. (see page 79). ADA Compliant. *Painted for shipping & display only; grate will form iron-oxide patina | | | | | | |

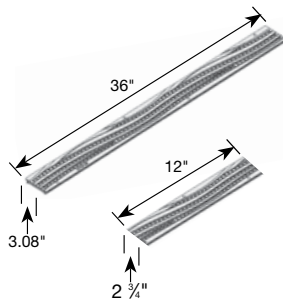

| Part No. | Description | Color | Pkg. Qty. | Wt. Ea. (lbs.) | Product Class | Specifications |
|---|------------------------------------|--------|-----------|----------------|---------------|---|
| 846 | Stainless Steel Screws, FH #4 x 1" | Steel | 64 | 0.10 | 25PF | 3 ft. Structural Foam Polyolefin wave pattern Channel Grate with UV inhibitor. Open surface area 5.73 square inches per foot. 17.54 GPM per foot. |
| 555S | 3' Wave Channel Grate | Sand | 16 | 0.88 | 25PF | |
| 555GR | 3' Wave Channel Grate | Green | 16 | 0.88 | 25PF | |
| 555GY | 3' Wave Channel Grate | Gray | 16 | 0.88 | 25PF | |
| 555 | 3' Wave Channel Grate | Black | 16 | 0.88 | 25PF | |
| 555CI | 1' Wave Cast Iron Channel Grate | Black* | 1 | 1.30 | 25PF | 1 ft. Mini Channel Wave Cast Iron Channel Grate. Open surface area 4.11 square inches per foot. 12.56 GPM per foot. Class B load rated. |
| Fits #500 Mini Channel. (see page 79). ADA Compliant. *Painted for shipping & display only; grate will form iron-oxide patina | | | | | | |

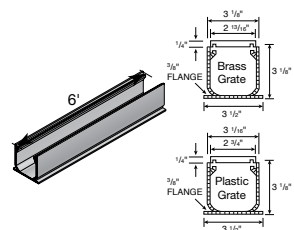

| Part No. | Description | Color | Pkg. Qty. | Wt. Ea. (lbs.) | Product Class | Specifications |
|--|-----------------------|-------|-----------|----------------|---------------|--|
| 500 | 6' Mini Channel Drain | Gray | 48 ft. | 3.26 | 25PF | 6 ft. PVC Mini Channel Drain with inverse flying-buttress design, bottom flange, patented honeycomb reinforced walls and UV inhibitor. |
| 500S | 6' Mini Channel Drain | Sand | 48 ft. | 3.26 | 25PF | |
| Grate should be recessed 1/8" below finish grade in non-traffic applications. Grate should be recessed 1/4" in traffic applications. | | | | | | |

PROFILE CHANNEL DRAINS

Mini Channel Accessories

Excellent for light duty applications, including residential pools, concrete and paver patios, spas and tennis courts.

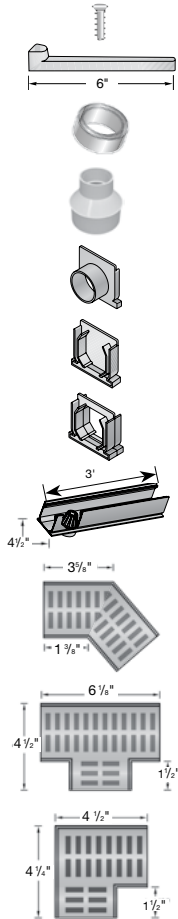

| Part No. | Description | Color | Pkg. Qty. | Wt. Ea. (lbs.) | Product Class |
|----------|--|-------|-----------|----------------|---------------|
| 529 | Stainless Steel Screws, FH #4 x 5/8" | Steel | 64 | 0.10 | 25PF |
| 230 | 6" Channel Installation Stake | Gray | 24 | 0.04 | 25PF |
| 532 | Adapter Bushing for Mini Channel 2" Bottom & End Outlet to 3" S&D Fittings | White | 20 | 0.14 | 30PV |
| 533 | Adapter for Mini Channel 2" Bottom & End Outlet to 4" S&D Fittings | White | 20 | 0.34 | 30PV |
| 546 | Mini Channel End Outlet to 2" Sch. 40 Pipe Fittings | Gray | 10 | 0.15 | 25PF |
| 546S | Mini Channel End Outlet to 2" Sch. 40 Pipe Fittings | Sand | 10 | 0.15 | 25PF |
| 547 | Mini Channel End Cap | Gray | 20 | 0.12 | 25PF |
| 547S | Mini Channel End Cap | Sand | 20 | 0.12 | 25PF |
| 548 | Mini Channel Coupling | Gray | 20 | 0.12 | 25PF |
| 548S | Mini Channel Coupling | Sand | 20 | 0.12 | 25PF |
| 550 | 3' Mini Channel Drain with Atrium Strainer and Bottom Outlet to 2" Sch. 40 Pipe Fittings | Gray | 6 | 2.17 | 25PF |
| 5300 | Fabricated 45° Elbow with Grate | Gray | 1 | 0.40 | 25PF |
| 5303 | Fabricated 45° Elbow with Grate | Sand | 1 | 0.40 | 25PF |
| 5370 | Fabricated Tee with Grate | Gray | 1 | 0.50 | 25PF |
| 5372 | Fabricated Tee with Grate | Black | 1 | 0.50 | 25PF |
| 5380 | Fabricated 90° Elbow with Grate | Gray | 1 | 0.40 | 25PF |
| 5383 | Fabricated 90° Elbow with Grate | Sand | 1 | 0.40 | 25PF |

CHANNEL & TRENCH DRAINS

Profile Channel Paver Installation

NDS Profile Channel Systems and grates are dimensionally compatible with standard 2-3/8" clay and concrete paving systems. Both decorative and standard grate options make Profile Channel an ideal choice for drainage on paver pool decks, patios, plazas, courtyards and parking courts.



PROFILE CHANNEL DRAINS

Spee-D® Channel Drains

Ideal for commercial as well as residential applications. Effective in everything from patios to light vehicular traffic areas.

CHANNEL & TRENCH DRAINS

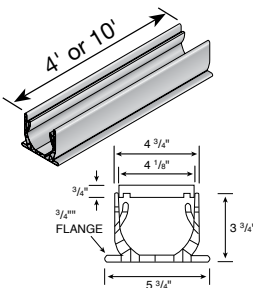
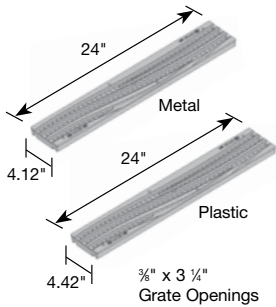
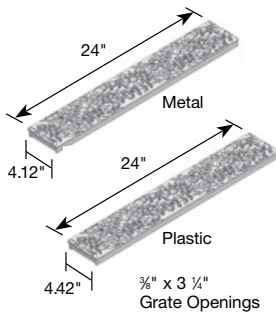
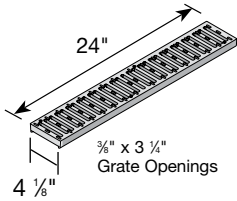

| Part No. | Description | Color | Pkg. Qty. | Wt. Ea. (lbs.) | Product Class | Specifications | |
|-------------------------------|--|------------------|-----------|----------------|---------------|---|--|
| 229 | Stainless Steel Screws, FH #8 X 1" for Spee-D Channel Plastic Slotted Grates | Steel | 48 | 0.06 | 25PF | 2 ft. Structural Foam Polyolefin Secured Channel Grate with UV inhibitor. Open surface area 16.76 square inches per foot. 51.27 GPM per foot. | |
| 240 | 2' Channel Slotted Grate | White | 24 ft. | 1.33 | 25PF | | |
| 241 | 2' Channel Slotted Grate | Gray | 24 ft. | 1.33 | 25PF | | |
| 242 | 2' Channel Slotted Grate | Green | 24 ft. | 1.33 | 25PF | | |
| 243 | 2' Channel Slotted Grate | Black | 24 ft. | 1.33 | 25PF | | |
| 244 | 2' Channel Slotted Grate | Sand | 24 ft. | 1.33 | 25PF | | |
| 251 | 2' Channel Slotted Grate | Brick Red | 24 ft. | 1.42 | 25PF | | |
| 254 | 2' Galvanized Steel Channel Grate | Galvanized Steel | 24 ft. | 1.90 | 25PF | | |
| (see page 79). ADA Compliant. | | | | | | | |

| Part No. | Description | Color | Pkg. Qty. | Wt. Ea. (lbs.) | Product Class | Specifications |
|--|---|--------|-----------|----------------|---------------|---|
| 829 | Stainless Steel Screws, FH #8 X 1-1/4" for Spee-D Channel Decorative Plastic Grates | Steel | 40 | 0.15 | 25PF | 2 ft. Structural Foam Polyolefin decorative botanical Channel Grate with UV inhibitor. Open surface area 7.78 square inches per foot. 23.80 GPM per foot. |
| 252S | 2' Channel Botanical Grate | Sand | 24 ft. | 1.74 | 25PF | |
| 252GR | 2' Channel Botanical Grate | Green | 24 ft. | 1.74 | 25PF | |
| 252GY | 2' Channel Botanical Grate | Gray | 24 ft. | 1.74 | 25PF | |
| 252 | 2' Channel Botanical Grate | Black | 24 ft. | 1.74 | 25PF | |
| 252CI | 2' Cast Iron Channel Botanical Grate | Black* | 2 ft. | 7.06 | 25PF | 2 ft. Cast Iron decorative botanical Channel Grate. Open surface area 8.99 square inches per foot. 27.50 GPM per foot. Class B load rated. |
| 229 | Stainless Steel Screws, FH #8 X 1" for Spee-D Channel Decorative Iron Grates | Steel | 48 | 0.06 | 25PF | |
| (see page 79). ADA Compliant. *Painted for shipping & display only; grate will form iron-oxide patina | | | | | | |

| Part No. | Description | Color | Pkg. Qty. | Wt. Ea. (lbs.) | Product Class | Specifications |
|--|---|--------|-----------|----------------|---------------|--|
| 829 | Stainless Steel Screws, FH #8 X 1-1/4" for Spee-D Channel Decorative Plastic Grates | Steel | 40 | 0.15 | 25PF | 2 ft. Structural Foam Polyolefin decorative wave Channel Grate with UV inhibitor. Open surface area 7.78 square inches per foot. 23.80 GPM per foot. |
| 253S | 2' Channel Wave Grate | Sand | 24 ft. | 1.84 | 25PF | |
| 253GR | 2' Channel Wave Grate | Green | 24 ft. | 1.84 | 25PF | |
| 253GY | 2' Channel Wave Grate | Gray | 24 ft. | 1.84 | 25PF | |
| 253 | 2' Channel Wave Grate | Black | 24 ft. | 1.84 | 25PF | |
| 253CI | 2' Cast Iron Channel Wave Grate | Black* | 2 ft. | 7.52 | 25PF | 2 ft. Cast Iron decorative wave Channel Grate. Open surface area 7.41 square inches per foot. 22.67 GPM per foot. Class B load rated. |
| 229 | Stainless Steel Screws, FH #8 X 1" for Spee-D Channel Decorative Iron Grates | Steel | 48 | 0.06 | 25PF | |
| (see page 79). ADA Compliant. *Painted for shipping & display only; grate will form iron-oxide patina | | | | | | |

| Part No. | Description | Color | Pkg. Qty. | Wt. Ea. (lbs.) | Product Class | Specifications |
|--|---|------------------|-----------|----------------|---------------|---|
| 400 | 4' Spee-D Channel Drain | Gray | 24 ft. | 4.83 | 25PF | PVC Channel Drain with Inverse Flying Buttress design, bottom flange, patented honeycomb reinforced walls and UV inhibitor. |
| 400-10 | 10' Spee-D Channel Drain | Gray | 60 ft. | 11.00 | 25PF | |
| 400-10WH | 10' Spee-D Channel Drain Assembly with pre-fastened Gray Plastic Grates | Gray | 60 ft. | 17.5 | 25PF | |
| 400-10MTL | 10' Spee-D Channel Drain Assembly with pre-fastened Galvanized Steel Grates | Galvanized Steel | 40 ft. | 20.5 | 25PF | |
| Grate should be recessed 1/8" below finish grade in non-traffic applications. Grate should be recessed 1/4" below finished grade in traffic applications. | | | | | | |

PROFILE CHANNEL DRAINS

Spee-D® Accessories

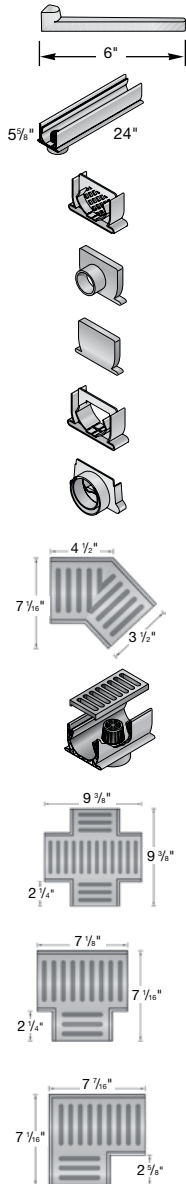

| Part No. | Description | Color | Pkg. Qty. | Wt. Ea. (lbs.) | Product Class |
|----------|--|-------|-----------|----------------|---------------|
| 230 | 6" Channel Installation Stake | Gray | 24 | 0.04 | 25PF |
| 234 | 2' Spee-D Channel Drain with Atrium Strainer and Bottom Outlet to 3" and 4" Sewer and Drain Fittings | Gray | 12 | 2.67 | 25PF |
| 245 | Spee-D Channel Strainer Coupling | Gray | 20 | 0.35 | 25PF |
| 246 | Spee-D Channel End Outlet to 2" Sch. 40 Pipe Fittings | Gray | 10 | 0.40 | 25PF |
| 247 | Spee-D Channel End Cap | Gray | 10 | 0.40 | 25PF |
| 248 | Spee-D Channel Coupling | Gray | 20 | 0.40 | 25PF |
| 249 | Spee-D Channel Offset End Outlet to 3" Sewer and Drain Pipe and 4" Sewer and Drain Fittings | Gray | 10 | 0.50 | 25PF |
| 2301 | Fabricated 45° Elbow with Grate | Gray | 1 | 2.00 | 25PF |
| 2351 | 7" Fabricated Grate 4" Bottom Outlet with Grate | Gray | 1 | 1.70 | 25PF |
| 2361 | Fabricated Cross and Grate | Gray | 1 | 3.00 | 25PF |
| 2371 | Fabricated Tee with Grate | Gray | 1 | 3.00 | 25PF |
| 2381 | Fabricated 90° Elbow with Grate | Gray | 1 | 3.00 | 25PF |

CHANNEL & TRENCH DRAINS

PRO SERIES CHANNEL DRAINS



NDS Pro Series is a lightweight channel drain system with interlocking joints and a modular design, so systems are flexible and connections are made quickly and easily.

Load Rated: Up to NDS Class C with appropriate grate.
For Residential and Commercial applications.

The NDS Pro Series modular design offers flexibility as each section of channel can be snapped together for longer runs or divided down to lengths as short as 4" for smaller, interlocking sections.

Lightweight parts connect easily to sewer and drain pipe and fittings or Sch 40 pipe and fittings, and side and bottom outlets can be connected anywhere along the channel run.

- Channel-to-channel clips for reduced motion during installation
- Rebar clips instead of lower mount clips for an easier install
- Side ribs for increased strength
- Lay-flat design stabilizes channel during installation
- Thicker channel walls for additional strength

All this, and the channel still fits easily with all grates and end connectors.

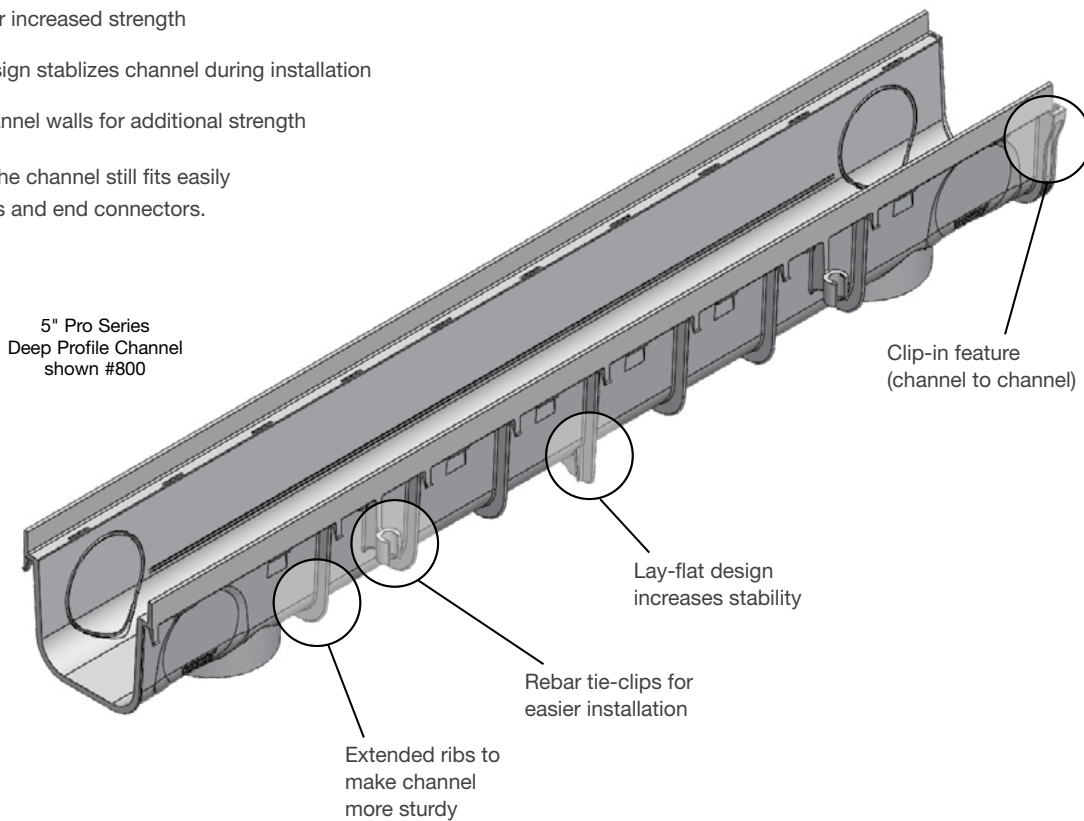

PRO SERIES CHANNEL DRAINS

Details

- Create a channel as long as you need, or reduce to lengths as short as 4" for smaller, interlocking sections.
- End cap/Knockout end and outlet fitting simplify assembly and installation.
- Flexible and easy: side and bottom outlets can be inserted at any location along the channel run.
- Available in four widths: 3", 5", 8" and 12"
- Available in two depths: deep for heavy flows, shallow for slabs or where little fall depth is available.
- Modular design comes in 1/2 meter (19 11/16") and 1 meter (39 3/8") pieces with interlocking end joints.
- Joints eliminate couplings and are specially designed to withstand concrete expansion and contraction.

Materials & Standards

- Polypropylene (3" & 5" channels) and polyvinyl chloride (8" & 12" channels) create a structurally-compact, water-tight channel.
- All parts contain UV inhibitors to prevent fading and cracking.

Load Recommendations

- Pedestrian Grates offer heel-proof pattern.
- Polyolefin Light Vehicular Grate for use in areas with passenger vehicles and light trucks with speeds less than 20 MPH.
- Load Star or Ductile Channel Grates for heavy-duty traffic.
- See individual products for details.

Pre-Assembled Channel Drain Systems

Our Modular Pro Series channel drains also come in pre-assembled kits to decrease installation time. They act as perimeter drains, quickly removing water from hardscapes and directing it away from building structures.

The 3" and 5" wide pre-assembled channel drain kits include a one-meter (39-3/8") channel drain and grate, end outlet, and end cap. A bottom outlet is built into each channel section. This allows for easy ordering and less inventorying, as everything is included under one part number.

Our unique Pro Series interlocking channel design allows each channel to securely lock to the next for a secure, tight fit, with no couplings required. The pre-assembled Pro Series channel drains are a great solution for your drainage needs.

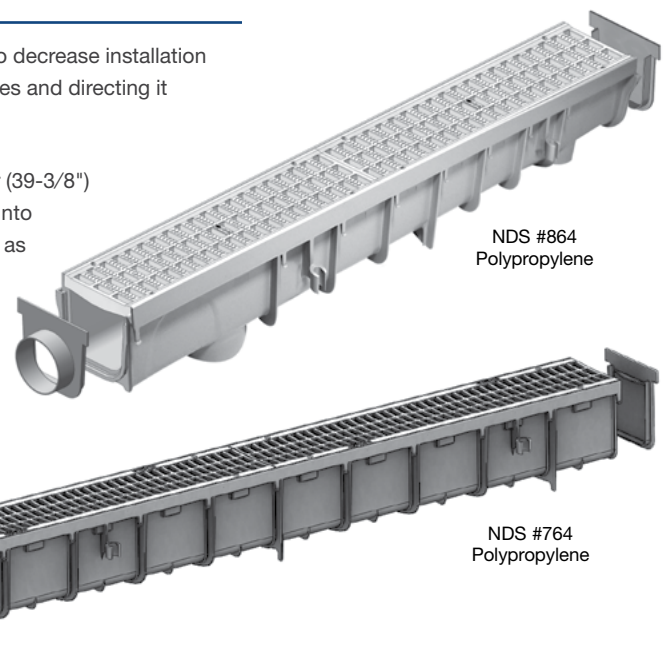
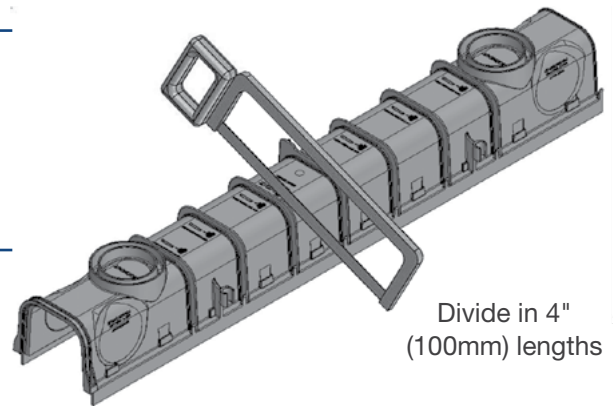

PRO SERIES CHANNEL DRAINS

CHANNEL & TRENCH DRAINS

3" Pro Series Channel™ Drains

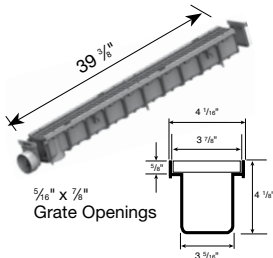

| Part No. | Description | Color | Pkg. Qty. | Wt. Ea. (lbs.) | Product Class | Specifications |
|----------|--|------------|-----------|----------------|---------------|--|
| 764 | 3" x 1 Meter Light Traffic Channel Grate & Channel Drain Kit | Light Gray | 10 | 3.50 | 25IN | 3" wide Light Traffic Channel Grate and Channel Drain with mechanical interlocking joints and UV inhibitors. Open surface area 23.63 square inches per foot. 76.85 GPM per foot. |
| | Includes 1 end outlet (#713) and 1 end cap (#712). Bottom and end outlets fit 3" S&D fittings. Grate should be recessed 1/8" below finish grade in non-traffic applications. Grate should be recessed 1/4" in traffic applications. (see page 79). ADA Compliant. | | | | | |

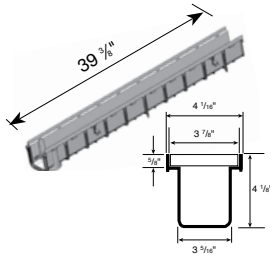

| Part No. | Description | Color | Pkg. Qty. | Wt. Ea. (lbs.) | Product Class | Specifications |
|----------|--|------------|-----------|----------------|---------------|---|
| 710 | 3" x 1 Meter Channel Drain* | Light Gray | 12 | 1.90 | 25IN | 3" wide Light Traffic Channel with mechanical interlocking joints and UV inhibitors. Polypropylene. |
| | Bottom outlet fits 3" S&D fittings. Grate should be recessed 1/8" below finish grade in non-traffic applications. Grate should be recessed 1/4" in traffic applications. *Produced under license of First Plast S.R.L.- Italy. (see page 79). ADA Compliant. | | | | | |

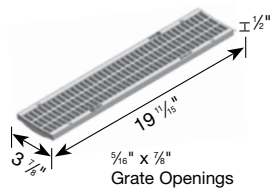

| Part No. | Description | Color | Pkg. Qty. | Wt. Ea. (lbs.) | Product Class | Specifications |
|----------|---|------------|-----------|----------------|---------------|---|
| 714 | 3" x 20" Light Traffic Channel Grate* | Light Gray | 24 | 0.70 | 25IN | 3" wide Light Traffic Channel Grate. Open surface area 23.63 square inches per foot. 72.29 GPM per foot. Polypropylene. |
| | Requires 4 #229 screws. *Produced under license of First Plast S.R.L.- Italy. (see page 79). ADA Compliant. | | | | | |



| Part No. | Description | Color | Pkg. Qty. | Wt. Ea. (lbs.) | Product Class | Specifications |
|----------|-----------------------|------------|-----------|----------------|---------------|---|
| 713 | 3" End Cap/End Outlet | Light Gray | 12 | 0.10 | 25IN | 3" Channel End Cap/End Outlet. Polypropylene. |
| | Fits 3" Fittings. | | | | | |

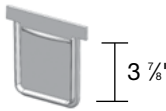

| Part No. | Description | Color | Pkg. Qty. | Wt. Ea. (lbs.) | Product Class | Specifications |
|----------|-------------|------------|-----------|----------------|---------------|------------------------------------|
| 712 | 3" End Cap | Light Gray | 20 | 0.05 | 25IN | 3" Channel End Cap. Polypropylene. |





| Part No. | Description | Color | Pkg. Qty. | Wt. Ea. (lbs.) | Product Class | Specifications |
|----------|-----------------------------------|-------|-----------|----------------|---------------|----------------|
| 229 | Stainless Steel Screws FH H8 x 1" | Steel | 48 | 0.06 | 25PF | |

PRO SERIES CHANNEL DRAINS

5" Pro Series Channel™ Drains

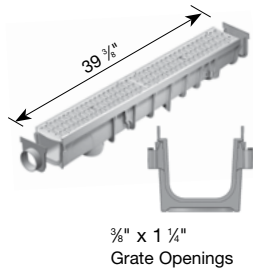
CHANNEL & TRENCH DRAINS



| Part No. | Description | Color | Pkg. Qty. | Wt. Ea. (lbs.) | Product Class | Specifications |
|---|---|------------------|----------------|----------------|---------------|---|
| 864 | 5" x 1 Meter Light Traffic Channel Kit with Light Gray Plastic Grates. Includes 1 End Outlet & 1 Cap | Light Gray | 9 | 5.67 | 25IN | 5" wide Light Traffic Channel Drain Kits and Displays. |
| 864DISPLAY | 5" Pro Series Channel Kit with Plastic Grate Display (9 kits) | Light Gray | 1 box = 9 kits | 51.03 | 25IN | See related specifications for 800 Channel and 814 & 824 Grates. |
| 864GRTL | 5" x 1 Meter Light Traffic Channel Kit with Galvanized Steel Grates. Includes 1 End Outlet & 1 Cap | Galvanized Steel | 9 | 6.15 | 25IN | Includes channel, grates, screws, end cap and end cap/outlet. |
| 864GRTLDISP | 5" Pro Series Channel Kit with Steel Grate Display (9 kits) | Galvanized Steel | 1 box = 9 kits | 55.35 | 25IN | DISP includes 9 kits either light gray plastic or galvanized steel grates |
|  | Grate should be recessed 1/8" below finish grade in non-traffic applications. Grate should be recessed 1/4" below finish grade in traffic applications. (see page 79). ADA Compliant. | | | | | |

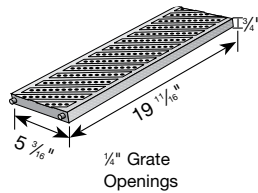

| Part No. | Description | Color | Pkg. Qty. | Wt. Ea. (lbs.) | Product Class | Specifications |
|---|---|------------|-----------|----------------|---------------|--|
| 826 | 5" x 20" Pedestrian Traffic Channel Grate | Light Gray | 10 | 1.00 | 25IN | 5" wide UV-protected Structural Foam Polyolefin Pedestrian Traffic Channel Grate. Open surface area 4.86 square inches per foot. 24.26 GPM per foot. |
|  | Requires #829 screws. (see page 79). ADA Compliant/Heelproof. | | | | | |

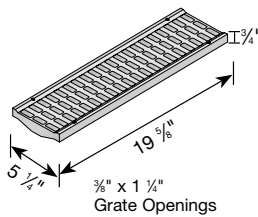

| Part No. | Description | Color | Pkg. Qty. | Wt. Ea. (lbs.) | Product Class | Specifications |
|---|---|------------------|-----------|----------------|---------------|--|
| 814 | 5" x 20" Light Traffic Channel Grate | Light Gray | 10 | 1.16 | 25IN | 5" wide Structural Foam Polyolefin Light Traffic Channel Grate with UV inhibitors. Open surface area 23.52 square inches per foot. 71.95 GPM per foot. |
| 815 | 5" x 20" Light Traffic Channel Grate | Green | 10 | 1.16 | 25IN | |
| 816 | 5" x 20" Light Traffic Channel Grate | Black | 10 | 1.16 | 25IN | |
| 817 | 5" x 20" Light Traffic Channel Grate | Sand | 10 | 1.16 | 25IN | |
| 818 | 5" x 20" Light Traffic Channel Grate | Brick Red | 10 | 1.16 | 25IN | |
| 819 | 5" x 20" Light Traffic Channel Grate | White | 10 | 1.16 | 25IN | |
| 824 | 5" x 20" Galvanized Steel Light Traffic Channel Grate | Galvanized Steel | 10 | 1.14 | 25IN | |
|  | Requires #829 screws. (see page 79). ADA Compliant. | | | | | |

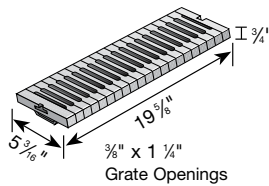

| Part No. | Description | Color | Pkg. Qty. | Wt. Ea. (lbs.) | Product Class | Specifications |
|---|--|-------|-----------|----------------|---------------|--|
| 828 | 5" x 20" Load Star Heavy Traffic Channel Grate | Gray | 10 | 2.35 | 25IN | 5" wide UV-protected high-impact glass-reinforced nylon Heavy Traffic Channel Grate. Open surface area 15.92 square inches per foot. 48.70 GPM per foot. |
|  | Requires 4 screws per grate. Requires #829 screws. (see page 79) | | | | | |

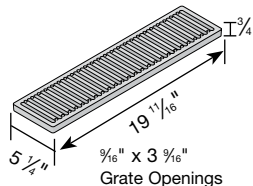

| Part No. | Description | Color | Pkg. Qty. | Wt. Ea. (lbs.) | Product Class | Specifications |
|---|---|--------|-----------|----------------|---------------|---|
| 823 | 5" x 20" Ductile Channel Grate | Black* | 1 | 12.30 | 25IN | 5" wide heavy-duty Ductile Heavy Traffic Channel Grate. Open surface area 22.90 square inches per foot. 70.05 GPM per foot. |
|  | Requires #829 screws. (see page 79). ADA Compliant. *Painted for shipping & display only; grate will form iron-oxide patina | | | | | |



| Part No. | Description | Color | Pkg. Qty. | Wt. Ea. (lbs.) | Product Class | Specifications |
|----------|---------------------------------------|-------|-----------|----------------|---------------|----------------|
| 829 | Stainless Steel Screws FH #6 x 1 1/4" | Steel | 40 | 0.15 | 25PF | |

PRO SERIES CHANNEL DRAINS

CHANNEL & TRENCH DRAINS

5" Pro Series Channel™ Drains (continued)

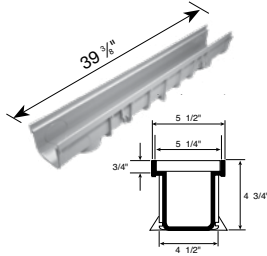

| Part No. | Description | Color | Pkg. Qty. | Wt. Ea. (lbs.) | Product Class | Specifications |
|----------|---|------------|-----------|----------------|---------------|--|
| 800 | 5" x 1 Meter Deep Profile Channel Drain | Light Gray | 10 | 4.00 | 25IN | 5" wide Deep Profile Channel Drain with interlocking joints, side rebar clips, integrated side and bottom outlet Knockouts. Polypropylene. |
| | New Integrated side outlet Knockouts fit 3" S&D pipe Integrated Knockout bottom outlet fits 3" and 4" S&D fittings. Grate should be recessed 1/8" below finish grade in non-traffic applications. Grate should be recessed 1/4" in traffic applications. | | | | | |

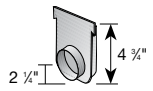

| Part No. | Description | Color | Pkg. Qty. | Wt. Ea. (lbs.) | Product Class | Specifications |
|----------|---|------------|-----------|----------------|---------------|---|
| 813 | 5" Deep Profile End Cap/3" S&D Hub & 4" S&D SPT Knockout End Outlet | Light Gray | 10 | 0.40 | 25IN | 5" wide Deep Profile End Cap/End Outlet. PVC. |

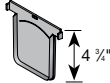

| | | | | | | |
|-----|-------------------------|------------|----|------|------|------------------------------------|
| 812 | 5" Deep Profile End Cap | Light Gray | 10 | 0.13 | 25IN | 5" wide Deep Profile End Cap. PVC. |
|-----|-------------------------|------------|----|------|------|------------------------------------|

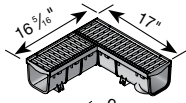

| | | | | | | |
|-----|---|------------|---|------|------|--|
| 861 | 5" Deep Profile Grate & Channel Drain 90° Elbow | Light Gray | 1 | 3.44 | 25IN | |
|-----|---|------------|---|------|------|--|

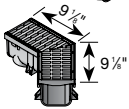

| | | | | | | |
|-----|---|------------|---|------|------|--|
| 862 | 5" Deep Profile Grate & Channel Drain 45° Elbow | Light Gray | 1 | 3.44 | 25IN | |
|-----|---|------------|---|------|------|--|



| | | | | | | |
|----------|---|------------|---|------|------|--|
| PSRC-864 | Quik-Turn™ 5" Deep Radius Coupling Provides a 6 degree bend left or right | Light Gray | 9 | 0.30 | 25IN | |
|----------|---|------------|---|------|------|--|

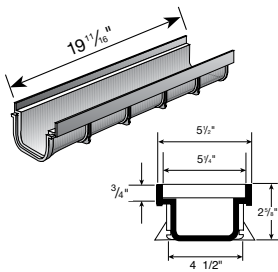

| Part No. | Description | Color | Pkg. Qty. | Wt. Ea. (lbs.) | Product Class | Specifications |
|----------|---|------------|-----------|----------------|---------------|--|
| 820 | 5" x 20" Shallow Profile Channel Drain* | Light Gray | 10 | 1.35 | 25IN | 5" wide Shallow Profile UV-protected high-impact PVC Channel Drain with mechanical interlocking joint. |
| | Grate should be recessed 1/8" below finish grade in non-traffic applications. Grate should be recessed 1/4" in traffic applications. *Produced under license of First Plast S.R.L. - Italy. | | | | | |

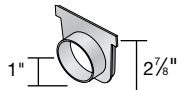

| Part No. | Description | Color | Pkg. Qty. | Wt. Ea. (lbs.) | Product Class | Specifications |
|----------|--|------------|-----------|----------------|---------------|---|
| 821 | 5" Shallow Profile End Cap/1-1/2" Sch. 40 SPT Knockout End Outlet* | Light Gray | 10 | 0.15 | 25IN | 5" wide Shallow Profile high-impact PVC End Cap/End Outlet. |
| | End Outlet fits 1-1/2" Schedule 40 fittings. *Produced under license of First Plast S.R.L. - Italy. | | | | | |

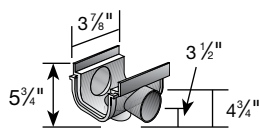

| Part No. | Description | Color | Pkg. Qty. | Wt. Ea. (lbs.) | Product Class | Specifications |
|----------|--|------------|-----------|----------------|---------------|---|
| 822 | 5" Shallow Profile 3" S&D SPT Bottom Outlet/1 1/2" Sch. 40 Hub Side Outlet | Light Gray | 10 | 0.60 | 25IN | 5" wide Shallow Profile high-impact PVC Bottom/Side Outlet. |
| | Side Outlets fit 1-1/2" Schedule 40 pipe Bottom Outlet fits 3" S&D fittings | | | | | |

PRO SERIES CHANNEL DRAINS

8" Pro Series Channel™ Drains

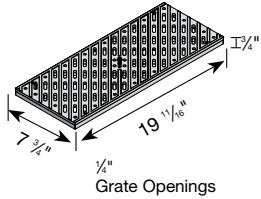

| Part No. | Description | Color | Pkg. Qty. | Wt. Ea. (lbs.) | Product Class | Specifications |
|---|---|------------|-----------|----------------|---------------|---|
| 836 | 8" x 20" Pedestrian Traffic Channel Grate | Light Gray | 1 | 1.55 | 25IN | 8" wide UV-protected Structural Foam Polyolefin Pedestrian Traffic Channel Grate. Open surface area 13.82 square inches per foot. 42.28 GPM per foot. |
|  | Requires #829 screws. 4 screws per grate. (see page 79). ADA Compliant/Heelproof. | | | | | |

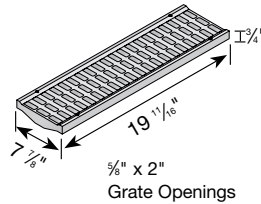

| Part No. | Description | Color | Pkg. Qty. | Wt. Ea. (lbs.) | Product Class | Specifications |
|---|---|------------|-----------|----------------|---------------|--|
| 837 | 8" x 20" Light Traffic Channel Grate | Light Gray | 1 | 3.00 | 25IN | 8" wide UV-protected Structural Foam Polyolefin Light Traffic Channel Grate. Open surface area 30.28 square inches per foot. 92.63 GPM per foot. |
|  | Requires #829 screws. 4 screws per grate. (see page 79) | | | | | |

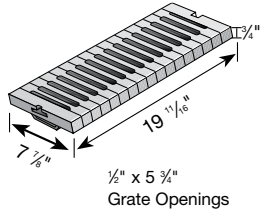

| Part No. | Description | Color | Pkg. Qty. | Wt. Ea. (lbs.) | Product Class | Specifications |
|---|--|------------|-----------|----------------|---------------|--|
| 838 | 8" x 20" Load Star Heavy Traffic Channel Grate* | Light Gray | 1 | 3.59 | 25IN | 8" wide UV-protected high-impact glass-reinforced nylon Heavy Traffic Channel Grate. Open surface area 30.85 square inches per foot. 94.37 GPM per foot. |
|  | Requires #829 screws. 4 screws per grate. *Produced under license of First Plast S.R.L. - Italy. (see page 79). ADA Compliant. | | | | | |

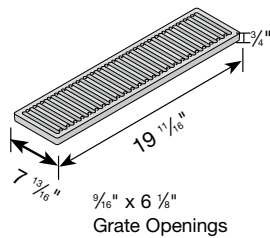

| Part No. | Description | Color | Pkg. Qty. | Wt. Ea. (lbs.) | Product Class | Specifications |
|---|--|--------|-----------|----------------|---------------|---|
| 888 | 8" x 20" Ductile Channel Grate | Black* | 1 | 22.24 | 25IN | 8" wide heavy-duty Ductile Heavy Traffic Channel Grate. Open surface area 23.80 square inches per foot. 71.28 GPM per foot. |
|  | *Painted for shipping & display only; grate will form iron-oxide patina #829 screws may be used. 4 screws per grate. (see page 79) | | | | | |



| Part No. | Description | Color | Pkg. Qty. | Wt. Ea. (lbs.) | Product Class | Specifications |
|----------|---------------------------------------|-------|-----------|----------------|---------------|----------------|
| 829 | Stainless Steel Screws FH #6 x 1 1/4" | Steel | 40 | 0.15 | 25PF | |

PRO SERIES CHANNEL DRAINS

8" Pro Series Channel™ Drains (continued)

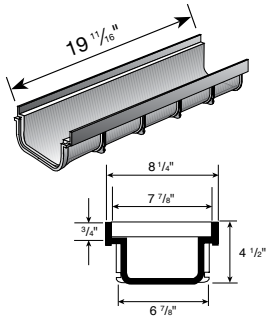

| Part No. | Description | Color | Pkg. Qty. | Wt. Ea. (lbs.) | Product Class | Specifications |
|---|---|------------|-----------|----------------|---------------|--|
| 830 | 8" x 20" Shallow Profile Channel Drain* | Light Gray | 1 | 2.00 | 25IN | 8" wide Shallow Profile high-impact PVC Channel Drain with mechanical interlocking joints and UV inhibitors. |
| Grate should be recessed 1/8" below finish grade in non-traffic applications. Grate should be recessed 1/4" in traffic applications. *Produced under license of First Plast S.R.L. - Italy. | | | | | | |

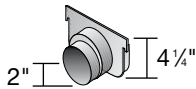

| Part No. | Description | Color | Pkg. Qty. | Wt. Ea. (lbs.) | Product Class | Specifications |
|---|---|------------|-----------|----------------|---------------|--|
| 831 | 8" Shallow Profile End Cap/ 3" S&D SPT Knockout End Outlet* | Light Gray | 1 | 0.49 | 25IN | 8" wide Shallow Profile high-impact PVC End Cap/ End Outlet. |
| End Outlet fits 3" Sewer and Drain fittings *Produced under license of First Plast S.R.L. - Italy. | | | | | | |

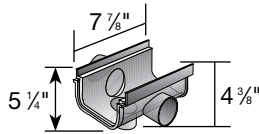

| Part No. | Description | Color | Pkg. Qty. | Wt. Ea. (lbs.) | Product Class | Specifications |
|---|--|------------|-----------|----------------|---------------|--|
| 832 | 8" Shallow Profile 3" S&D SPT Side Outlet* | Light Gray | 1 | 1.38 | 25IN | 8" wide Shallow Profile high-impact PVC Bottom/Side Outlets with bottom adapter. |
| Bottom outlet fits 4" S&D pipe, side outlets fit 3" Sewer and Drain fittings. *Produced under license of First Plast S.R.L. - Italy. | | | | | | |

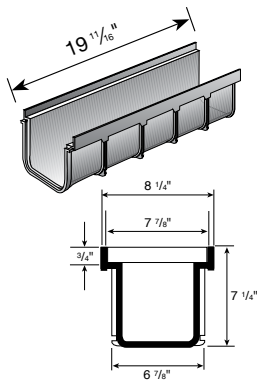

| Part No. | Description | Color | Pkg. Qty. | Wt. Ea. (lbs.) | Product Class | Specifications |
|---|-------------------------------------|------------|-----------|----------------|---------------|---|
| 833 | 8" x 20" Deep Profile Channel Drain | Light Gray | 1 | 2.80 | 25IN | 8" wide Deep Profile high-impact PVC Channel Drain with mechanical interlocking joints and UV inhibitors. |
| Grate should be recessed 1/8" below finish grade in non-traffic applications. Grate should be recessed 1/4" in traffic applications. | | | | | | |

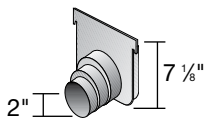

| Part No. | Description | Color | Pkg. Qty. | Wt. Ea. (lbs.) | Product Class | Specifications |
|--|--|------------|-----------|----------------|---------------|--|
| 834 | 8" Deep Profile End Cap/3"& 4" S&D SPT Knockout End Outlet | Light Gray | 10 | 0.51 | 25IN | 8" wide Deep Profile high-impact PVC End Cap/End Outlet. |
| End Outlet fits 3" and 4" Sewer and Drain fittings *Produced under license of First Plast S.R.L. - Italy. | | | | | | |

PRO SERIES CHANNEL DRAINS

12" Pro Series Channel™ Drains

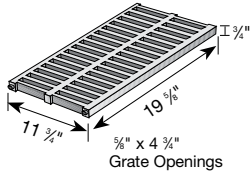

| Part No. | Description | Color | Pkg. Qty. | Wt. Ea. (lbs.) | Product Class | Specifications |
|----------|---|-------|-----------|----------------|---------------|---|
| 847 | 12" x 20" Light Traffic Channel Grate* | Gray | 1 | 4.64 | 25IN | 12" wide UV-protected high-impact PVC Light Traffic Channel Grate. Open surface area 48.77 square inches/foot. 149.19 GPM per foot. |
| | *Produced under license of First Plast S.R.L.- Italy. (see page 79) | | | | | |

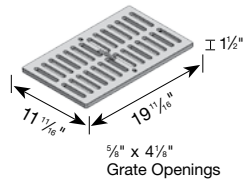

| Part No. | Description | Color | Pkg. Qty. | Wt. Ea. (lbs.) | Product Class | Specifications |
|----------|---|--------|-----------|----------------|---------------|--|
| 885 | 12" x 20" Ductile Iron Heavy Traffic Channel Grate | Black* | 1 | 29.30 | 25IN | 12" Wide Cast Iron Heavy Traffic Channel Grate. Open surface area 46.70 square inches per foot. 142.86 GPM per foot. |
| | *Painted for shipping & display only; grate will form iron-oxide patina (see page 79) | | | | | |

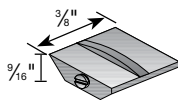

| Part No. | Description | Color | Pkg. Qty. | Wt. Ea. (lbs.) | Product Class | Specifications |
|----------|--|-------|-----------|----------------|---------------|----------------|
| 849 | Grate Security Clip* | Gray | 10 | 0.40 | 25IN | |
| | For use with 847 and 885 grates and 840 or 843 channels only (2 per grate). Mounts inside channel drain and secures grate. Screw and nut included. *Produced under license of First Plast S.R.L.- Italy. | | | | | |

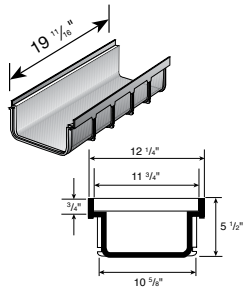

| Part No. | Description | Color | Pkg. Qty. | Wt. Ea. (lbs.) | Product Class | Specifications |
|----------|--|------------|-----------|----------------|---------------|--|
| 840 | 12" x 20" Shallow Profile Channel Drain | Light Gray | 1 | 4.00 | 25IN | 12" wide Shallow Profile UV-protected high-impact PVC Channel Drain with mechanical interlocking joints. |
| | Grate should be recessed 1/8" below finish grade in non-traffic applications. Grate should be recessed 1/4" in traffic applications. | | | | | |

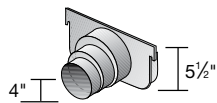

| Part No. | Description | Color | Pkg. Qty. | Wt. Ea. (lbs.) | Product Class | Specifications |
|----------|---|------------|-----------|----------------|---------------|---|
| 841 | 12" Shallow Profile End Cap/End Outlet Knockout with 4" S&D Hub* Fits 4" Sewer and Drain pipe | Light Gray | 1 | 1.00 | 25IN | 12" wide Shallow Profile high-impact PVC End Cap/Outlet with adapter. |
| | *Produced under license of First Plast S.R.L.- Italy. | | | | | |

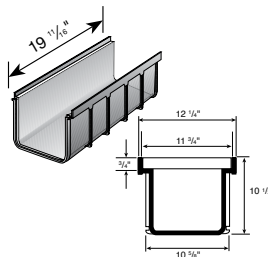

| Part No. | Description | Color | Pkg. Qty. | Wt. Ea. (lbs.) | Product Class | Specifications |
|----------|--|------------|-----------|----------------|---------------|---|
| 843 | 12" x 20" Deep Profile Channel Drain* | Light Gray | 1 | 6.00 | 25IN | 12" wide Deep Profile UV-protected high-impact PVC Channel Drain with mechanical interlocking joints. |
| | Grate should be recessed 1/8" below finish grade in non-traffic applications. Grate should be recessed 1/4" in traffic applications. *Produced under license of First Plast S.R.L.- Italy. | | | | | |

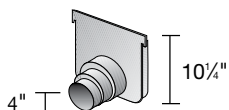

| Part No. | Description | Color | Pkg. Qty. | Wt. Ea. (lbs.) | Product Class | Specifications |
|----------|--|------------|-----------|----------------|---------------|--|
| 844 | 12" Deep Profile End Cap/End Outlet Knockout with 4" S&D Hub* Fits 4" Sewer and Drain pipe | Light Gray | 1 | 1.60 | 25IN | 12" wide Deep Profile high-impact PVC End Cap/Outlet with adapter. |
| | *Produced under license of First Plast S.R.L.- Italy. | | | | | |

DURA SLOPE™ TRENCH DRAIN – PRE-SLOPED (PATENTED)



NDS Dura Slope™ is a high-quality quality, dependable, best-in-class trench drain system ideal for a variety of drainage solutions, including driveways, parking areas, warehouses, loading docks, pools, wash down areas and other areas for the interception and collection of surface runoff. Dura Slope™ pre-sloped and neutral trench drain system provides a solution for residential, commercial, industrial and municipal drainage needs.

The NDS Dura Slope™ trench drain system consists of 33 channel sections; 24 pre-sloped sections with 0.7% built in slope and 9 neutral sections. The system also has a catch basin assembly. All Dura Slope™ channel sections are 48" long, grip #3 and #4 rebar and support 6" wide grates. Dura Slope™ channel sections are also available in depths from 4" to 12".

The sloped channel sections enable the Dura Slope™ system to extend to a length of 96 feet with continuous slope. The neutral channel sections can be used for non-sloped system runs or can be used in conjunction with the pre-sloped channel sections for an extended system run of 132 feet. By incorporating central collection using the catch basin assembly, the Dura Slope™ trench drain system can be extended up to 266 feet. The ProFit™ locking system maintains structural integrity during installation, and is a locking device and support for the grates. Each channel section ships with ProFit™, Blank Grate Inserts and grate screws installed.

Details

- Lightweight 4 ft. modular sections
- Easier handling and installation
- Lower freight costs
- 2" radius bottom minimizes debris build-up
- Polyethylene material
- Durable and inexpensive
- Less breakage versus concrete
- High chemical resistance
- Bottom outlet on each channel section
- System versatility
- Requires fewer accessories
- 0.7% built-in slope
- Maintains optimum flow rates throughout system

DURA SLOPE™ TRENCH DRAIN – PRE-SLOPED (PATENTED)

Product Features & Benefits

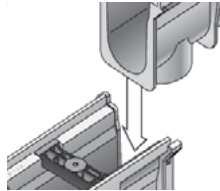

Interlocking tongue and groove joints

- Secures alignment
- Ensures straight channel runs
- Easy assembly and installation

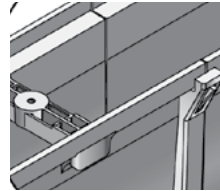

DuraLoc™ integral joint lock

- Prevents joint movement during installation
- No extra clamps or screws needed

Various grating options

- ADA compliant, Heel-Proof options
- Plastic grates
 - Array of colors
 - Pedestrian and light traffic rated
- Galvanized & stainless steel
 - Pedestrian & heavy traffic rated
- Cast & ductile iron
 - Class D heavy traffic rated (with frame)
- Decorative grates (ductile iron)
 - Standard black electrostatic coating
 - or raw iron Class C traffic rated

Lightweight 4 ft. modular sections

- Easier handling and installation
- Lower freight costs

Blank grate insert

- Eliminates use of plywood
- Slides for overlapping of channel sections
- Includes grates screws

Smooth HDPE interior

Virtually no water absorption

HDPE material

- Durable
- Inexpensive
- Less breakage versus concrete
- Chemical resistance

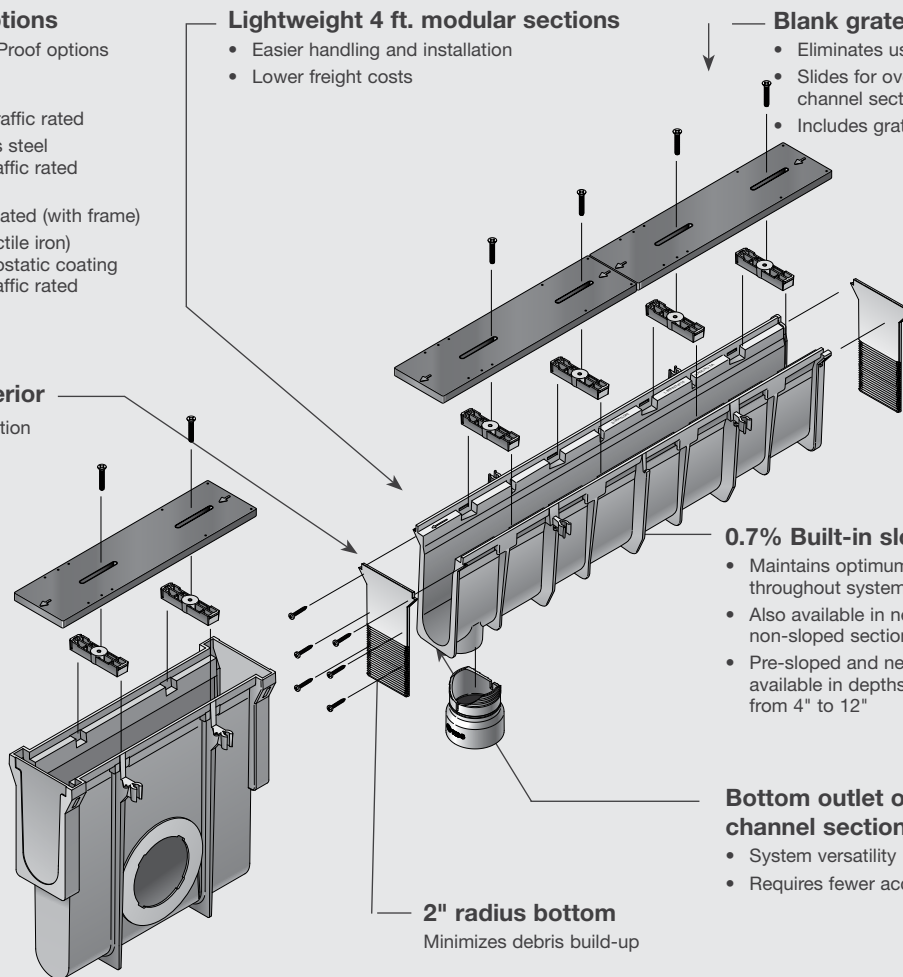

0.7% Built-in slope

- Maintains optimum flow rates throughout system
- Also available in neutrals; non-sloped sections
- Pre-sloped and neutrals available in depths from 4" to 12"

Bottom outlet on each channel section

- System versatility
- Requires fewer accessories

2" radius bottom

Minimizes debris build-up

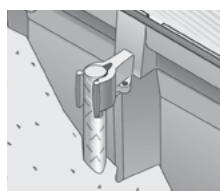

LevelLoc™ re-bar supports with integral protruding knob

- Levels channel and grips re-bar
- Requires fewer accessories

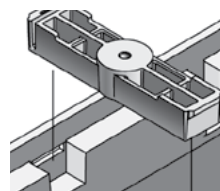

ProFit™ locking system

- Locks grate to integral frame
- Supports product in shipping and installation (included)

DURA SLOPE™ TRENCH DRAIN – PRE-SLOPED

Dura Slope™ Channel Drain Sections

CHANNEL & TRENCH DRAINS

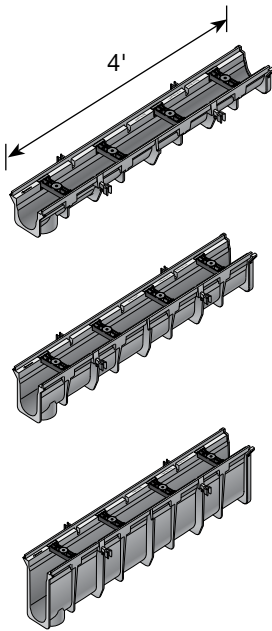

| Part No. | Description | Color | Pkg. Qty. | Wt. Ea. (lbs.) | Product Class |
|----------|--|------------|-----------|----------------|---------------|
| DS-090N | 3.99" Deep Neutral Dura Slope Channel | Light Gray | 1 | 7.45 | 25DS |
| DS-091 | 3.99" to 4.34" Deep Dura Slope Channel | Light Gray | 1 | 7.52 | 25DS |
| DS-091N | 4.34" Deep Neutral Dura Slope Channel | Light Gray | 1 | 7.81 | 25DS |
| DS-092 | 4.34" to 4.67" Deep Dura Slope Channel | Light Gray | 1 | 7.92 | 25DS |
| DS-093 | 4.67" to 5.00" Deep Dura Slope Channel | Light Gray | 1 | 8.27 | 25DS |
| DS-094 | 5.00" to 5.34" Deep Dura Slope Channel | Light Gray | 1 | 8.64 | 25DS |
| DS-094N | 5.34" Deep Dura Slope Channel | Light Gray | 1 | 8.93 | 25DS |
| DS-095 | 5.34" to 5.68" Deep Dura Slope Channel | Light Gray | 1 | 8.99 | 25DS |
| DS-096 | 5.68" to 6.01" Deep Dura Slope Channel | Light Gray | 1 | 9.36 | 25DS |
| DS-097 | 6.01" to 6.35" Deep Dura Slope Channel | Light Gray | 1 | 9.74 | 25DS |
| DS-097N | 6.35" Deep Neutral Dura Slope Channel | Light Gray | 1 | 10.04 | 25DS |
| DS-098 | 6.35" to 6.69" Deep Dura Slope Channel | Light Gray | 1 | 10.11 | 25DS |
| DS-099 | 6.69" to 7.02" Deep Dura Slope Channel | Light Gray | 1 | 10.48 | 25DS |
| DS-100 | 7.02" to 7.36" Deep Dura Slope Channel | Light Gray | 1 | 10.86 | 25DS |
| DS-100N | 7.36" Deep Neutral Dura Slope Channel | Light Gray | 1 | 11.16 | 25DS |
| DS-101 | 7.36" to 7.69" Deep Dura Slope Channel | Light Gray | 1 | 11.23 | 25DS |
| DS-102 | 7.69" to 8.03" Deep Dura Slope Channel | Light Gray | 1 | 11.60 | 25DS |
| DS-103 | 8.03" to 8.37" Deep Dura Slope Channel | Light Gray | 1 | 11.98 | 25DS |
| DS-103N | 8.37" Deep Neutral Dura Slope Channel | Light Gray | 1 | 12.27 | 25DS |
| DS-104 | 8.37" to 8.70" Deep Dura Slope Channel | Light Gray | 1 | 12.34 | 25DS |
| DS-105 | 8.70" to 9.04" Deep Dura Slope Channel | Light Gray | 1 | 12.71 | 25DS |
| DS-106 | 9.04" to 9.37" Deep Dura Slope Channel | Light Gray | 1 | 13.07 | 25DS |
| DS-106N | 9.37" Deep Neutral Dura Slope Channel | Light Gray | 1 | 13.39 | 25DS |
| DS-107 | 9.37" to 9.70" Deep Dura Slope Channel | Light Gray | 1 | 13.40 | 25DS |
| DS-108 | 9.70" to 10.05" Deep Dura Slope Channel | Light Gray | 1 | 13.83 | 25DS |
| DS-109 | 10.05" to 10.38" Deep Dura Slope Channel | Light Gray | 1 | 14.20 | 25DS |
| DS-109N | 10.38" Deep Neutral Dura Slope Channel | Light Gray | 1 | 14.50 | 25DS |
| DS-110 | 10.38" to 10.71" Deep Dura Slope Channel | Light Gray | 1 | 14.57 | 25DS |
| DS-111 | 10.71" to 11.05" Deep Dura Slope Channel | Light Gray | 1 | 14.95 | 25DS |
| DS-112 | 11.05" to 11.39" Deep Dura Slope Channel | Light Gray | 1 | 15.32 | 25DS |
| DS-112N | 11.39" Deep Neutral Dura Slope Channel | Light Gray | 1 | 15.60 | 25DS |
| DS-113 | 11.39" to 11.72" Deep Dura Slope Channel | Light Gray | 1 | 15.69 | 25DS |
| DS-114 | 11.72" to 12.06" Deep Dura Slope Channel | Light Gray | 1 | 16.06 | 25DS |

DURA SLOPE™ TRENCH DRAIN – PRE-SLOPED

Standard Grates

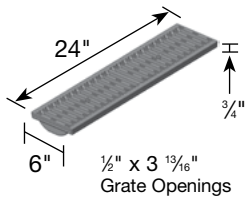

| Part No. | Description | Color | Pkg. Qty. | Wt. Ea. (lbs.) | Product Class | Specifications |
|---|---------------------|------------|-----------|----------------|---------------|--|
| 660 | 2 ft. Channel Grate | White | 24 ft. | 2.82 | 25DS | 2 ft. Structural Foam Polyolefin, secured Channel Grate with UV inhibitor. Open surface area 25.40 square inches per foot. 77.70 GPM per foot. |
| 661 | 2 ft. Channel Grate | Dark Gray | 24 ft. | 2.82 | 25DS | |
| 661LG | 2 ft. Channel Grate | Light Gray | 24 ft. | 2.82 | 25DS | |
| 662 | 2 ft. Channel Grate | Green | 24 ft. | 2.82 | 25DS | |
| 663 | 2 ft. Channel Grate | Black | 24 ft. | 2.82 | 25DS | |
| 664 | 2 ft. Channel Grate | Sand | 24 ft. | 2.82 | 25DS | |
| 665 | 2 ft. Channel Grate | Brick Red | 24 ft. | 2.82 | 25DS | |
|  Use with Dura Slope Drains (page 72), Dura Slope Catch Basins (page 74). (see page 79). ADA Compliant. | | | | | | |

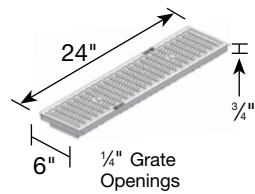

| Part No. | Description | Color | Pkg. Qty. | Wt. Ea. (lbs.) | Product Class | Specifications |
|---|--|------------|-----------|----------------|---------------|--|
| DS-670 | 2 ft. Plastic Perforated Channel Grate | Light Gray | 24 ft. | 2.81 | 25DS | 2 ft. Structural Foam Polyolefin, secured Channel Grate with UV inhibitor, light traffic rated, heelproof, ADA compliant. Open surface area 8.75 square inches per foot. 26.77 GPM per foot. |
| DS-671 | 2 ft. Plastic Perforated Channel Grate | White | 24 ft. | 2.81 | 25DS | |
|  Use with Dura Slope Drains (page 72), Dura Slope Catch Basins (page 74). (see page 79). ADA Compliant/Heelproof. | | | | | | |

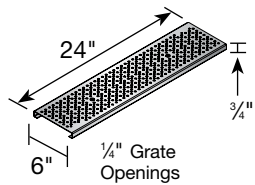

| Part No. | Description | Color | Pkg. Qty. | Wt. Ea. (lbs.) | Product Class | Specifications |
|---|---|-------|-----------|----------------|---------------|--|
| DS-226 | 2 ft. Stainless Steel Perforated Channel Grate | Steel | 24 ft. | 3.16 | 25DS | Perforated Metal Grate, pedestrian traffic rated, heelproof, ADA compliant. Open surface area 7.63 square inches per foot. 23.34 GPM per foot. |
| DS-228 | 2 ft. Galvanized Steel Perforated Channel Grate | Steel | 24 ft. | 3.83 | 25DS | |
|  Use with Dura Slope Drains (page 72), Dura Slope Catch Basins (page 74). (see page 79). ADA Compliant/Heelproof. | | | | | | |

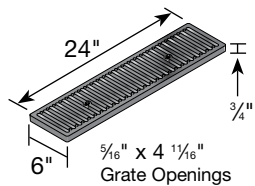

| Part No. | Description | Color | Pkg. Qty. | Wt. Ea. (lbs.) | Product Class | Specifications |
|---|-------------------------------|-------|-----------|----------------|---------------|--|
| DS-231 | 2 ft. Cast Iron Channel Grate | Black | 1 | 18.90 | 25DS | 2 ft. heavy-duty Iron Channel Grate. Open surface area 20.85 square inches per foot. 63.78 GPM per foot. H-20 load rating. |
| DS-232 | 2 ft. Ductile Iron | Black | 1 | 15.20 | 25DS | |
|  Use with Dura Slope Drains (page 72), Dura Slope Catch Basins (page 74). (see page 79). ADA Compliant. Must be used with DS-200H to achieve Class D Load Rating. | | | | | | |

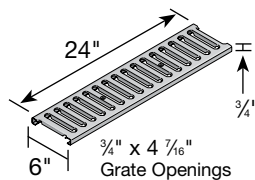

| Part No. | Description | Color | Pkg. Qty. | Wt. Ea. (lbs.) | Product Class | Specifications |
|--|--------------------------------------|-------|-----------|----------------|---------------|--|
| DS-221 | 2 ft. Galvanized Steel Channel Grate | Steel | 24 ft. | 6.64 | 25DS | 2 ft. Galvanized Rolled Steel Grate. Open surface area 23.09 square inches per foot. 70.64 GPM per foot. |
|  Use with Dura Slope Drains (page 72), Dura Slope Catch Basins (page 74). Includes bracket to attach grate to channel and screws. (see page 79) | | | | | | |

DURA SLOPE™ TRENCH DRAIN – PRE-SLOPED

Slot Top

CHANNEL & TRENCH DRAINS



| Part No. | Description | Color | Pkg. Qty. | Wt. Ea. (lbs.) | Product Class |
|---------------|---|------------------|-----------|----------------|---------------|
| DS-ST2 | 4 ft. Slot Top with Galvanized Steel Grate | Galvanized Steel | 1 | 17.53 | 25DS |
| DS-ST4 | 2 ft. Slot Top with Galvanized Steel Grate | Galvanized Steel | 1 | 8.86 | 25DS |
| DS-STMAINT | 2 ft. Slot Top Maintenance Unit | | 1 | 14.86 | 25DS |
| 17111201 | 48 in. Slot Top, Asymmetric, Galvanized Steel, NW 113, C 250KN, SW 15, 1218/151/133, SH 110 | Galvanized Steel | 40 | 17.53 | 25DS |
| 17111202 | 24 in. Slot Top, Asymmetric, Galvanized Steel, NW 113, C 250KN, SW 15, 609/151/133, SH 110 | Galvanized Steel | 40 | 8.86 | 25DS |
| 17111281 | 24 in. Maintenance Unit Galvanized Steel, NW 113, Asymmetric, SW 15 cl. C 250 KN | Galvanized Steel | 40 | 14.86 | 25DS |
| DS-SS-ST1000 | 48 in. Slot Top, Asymmetric, Stainless Steel, NW 113, C 250KN, SW 15, 1218/151/133, SH 110 | Stainless Steel | 40 | 17.13 | 25DS |
| DS-SS-ST500 | 24 in. Slot Top, Asymmetric, Stainless Steel, NW 113, C 250KN, SW 15, 609/151/133, SH 110 | Stainless Steel | 40 | 8.86 | 25DS |
| DS-SS-STMAINT | 24 in. Maintenance Unit Stainless Steel, NW 113, Asymmetric, SW 15 cl. C 250 KN | Stainless Steel | 40 | 14.86 | 25DS |
| 13399 | Opening Tool for Maintenance Unit (order 2) | N/A | 1 | 0.02 | 25FC |

Decorative Grates

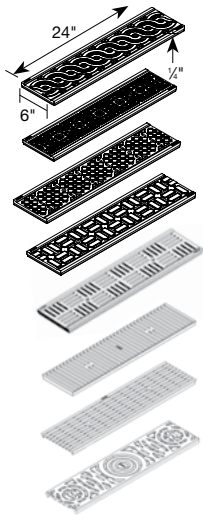

| Part No. | Description | Color | Pkg. Qty. | Wt. Ea. (lbs.) | Product Class | Specifications |
|---|-----------------|--------------|-----------|----------------|---------------|---|
| DS-601 | Weave Pattern | Raw Iron | 1 | 14.50 | 25DS | Decorative grates are made of ductile iron. Weave: open area 6.75 square inches per foot; 20.65 GPM. Diamond: open area 9.55 square inches per foot; 29.21 GPM. Tile: open area 7.95 square inches per foot; 24.32 GPM. Brick: open area 11.35 square inches per foot; 34.725 GPM. Deco slot: open area 16.75 square inches per foot; 51.24 GPM. |
| DS-602 | Diamond Pattern | Raw Iron | 1 | 14.30 | 25DS | |
| DS-603 | Tile Pattern | Raw Iron | 1 | 14.70 | 25DS | |
| DS-604 | Brick Pattern | Raw Iron | 1 | 14.30 | 25DS | |
| DS-609 | Deco Slot | Raw Iron | 1 | 14.50 | 25DS | |
| DS-610-KIARO | Kiaro Slot | Ductile Iron | 120 | 14.99 | 25DS | |
| DS-611-VIA | Via Slot | Ductile Iron | 120 | 10.36 | 25DS | |
| DS-612-VILLE | Ville Pattern | Ductile Iron | 120 | 11.68 | 25DS | |
| Use with Dura Slope Drains (page 72), Dura Slope Catch Basins (see below). Decorative grates are made of ductile iron. Uncoated raw iron will develop a rust patina over time. Additional powder-coat colors available: Black (K), White (W), Silver (S), Bronze (Z), Green (G), Blue (B), Orange (O), Gray (Y), Brown (N) (see page 79). ADA Compliant/Heel-proof. Must be used with DS-200H to achieve Class D Load Rating. | | | | | | |

In-Line Catch Basin

The NDS Dura Slope™ in-line catch basin is designed to fit all depth ranges of the Dura Slope™ trench drain sections. Catch basin inlets are designed to be sized as required to accept the Dura Slope™ trench drain section. The Dura Slope™ catch basin is 2 feet long and 2 feet deep with an outlet on both sides of the basin. One Universal Adapter Plug, one blank grate insert and two grate screws are included with each Dura Slope™ in-line catch basin. The NDS universal basin outlets are used to adapt the catch basin to 3", 4", 6" and 8" pipe.

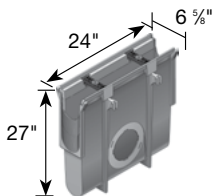

| Part No. | Description | Color | Pkg. Qty. | Wt. Ea. (lbs.) | Product Class |
|---|----------------------------------|------------|-----------|----------------|---------------|
| DS-340 | Dura Slope™ In-Line Catch Basins | Light Gray | 1 | 12.00 | 25DS |
| Available for use of one or two outlets. Use #1242, #1243, #1245, #1266, #1206 or #1888 Universal Outlets (see page 35). | | | | | |

DURA SLOPE™ TRENCH DRAIN – PRE-SLOPED

Trash Bucket

Dura Slope™ Trash Bucket is made to fit inside the Dura Slope™ Catch Basin (part number DS-340). It has a handle for easy removal to clean leaves and debris; it requires removal of the grate. Made of zinc plated steel, it is durable to climatic conditions. The Trash Bucket is not intended for use with any of the Dura Slope™ Channels. *Note: DS-240 Trash Bucket is not for use with the DS-200H Ductile Iron Frame.*

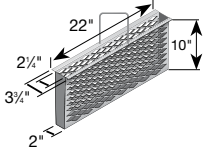

| Part No. | Description | Color | Pkg. Qty. | Wt. Ea. (lbs.) | Product Class |
|----------|--------------------------|-------------------------|-----------|----------------|---------------|
| DS-240 | Dura Slope™ Trash Bucket | Steel Zinc-Plated Steel | 1 | 5.00 | 25DS |

Accessories

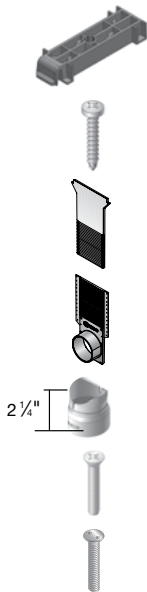

| Part No. | Description | Color | Pkg. Qty. | Wt. Ea. (lbs.) | Product Class |
|----------|--|-----------------|-----------|----------------|---------------|
| DS-122 | ProFit™ Grate Lock | Black | 8 | 0.80 | 25DS |
| DS-123 | Dura Slope Frame & End Cap Screws PH. #6 Use on DS-229 Universal End Cap & DS-227 x 3/4". Universal End Outlet downstream for (male) end. Use to attach DS-200 DI Frame to Channel. | Steel | 12 | | 25DS |
| DS-224 | Universal End Cap Replaces DS-124, which will not work with DS-113 or deeper channels. Slides into upstream (female) end. Requires DS-123 screws on downstream (male) end. | Gray | 8 | 0.63 | 25DS |
| DS-227 | Universal End Outlet Replaces DS-127, which will not work with DS-113 or deeper channels. Requires DS-123 screws for use on downstream (male) end. Fits to 4" S&D Pipe. | Gray | 6 | 0.75 | 25DS |
| DS-126 | Bottom Outlet Adapter Fits to 4" S&D Pipe. DS-126 not required for Sch. 40 connection. | Gray | 6 | 0.53 | 25DS |
| 629 | Grate Screws FH # 1/4 – 20 x 1-1/2" 2 Needed per Grate. Use with Grate # DS-231, DS-232, DS-670, DS-226 and 660-665. Use to secure grates in applications without DS-200 DI Frame | Stainless Steel | 40 | 0.70 | 25PF |
| DS-225 | Dura Slope™ Ductile Iron Frame Screws FH #1/4-20 x 2-1/2" Only Needed with DS-200H Frame. 2 Needed per Grate. | Steel | 12 | 0.05 | 25DS |
| DS-650 | Flat Drilled Spanner End Cap Screws #6, 3/4" Drill bit included with each package. | Steel | 12 | 1 | 25DS |

Ductile Iron Frame

Dura Slope Ductile Iron Frame provides a Class D load rating of 326-575 psi and is suitable for heavy-duty hard tire equipment at speeds less than 20 mph. The DS-200H Ductile Iron Frame is recommended for use with pneumatic tire traffic such as fork lifts. The ductile iron frame can be used with the cast and ductile iron grates. *Note: DS-123 screws must be ordered to secure frame to the channel.*

| Part No. | Description | Color | Pkg. Qty. | Wt. Ea. (lbs.) | Product Class |
|---|---|-------|-----------|----------------|---------------|
| DS-200H | Dura Slope™ Ductile Iron Frame | Black | 2 ft. | 7.50 | 25DS |
|  | Use with Dura Slope Drains (page 72), Dura Slope Catch Basins (page 74). To be used with DS-231 or DS-232 grates. New Feature: 1/4" Brass Nuts to secure channel inserted. (see page 79). ADA Compliant/Heel-proof when used with DS-231 or DS-232 grates. | | | | |

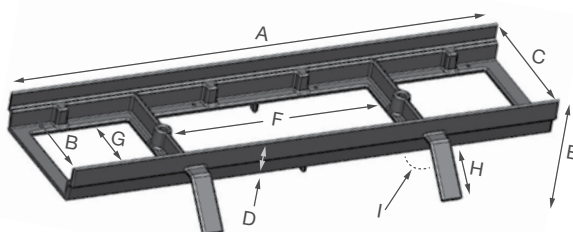

| Dimension Key | | |
|---------------|------------------|-----------|
| A | Length | 24" |
| B | Inner Width | 6" |
| C | Outer Width | 6-3/8" |
| D | Added Profile | 1" Height |
| E | Total Height | 2-3/4" |
| F | Opening Length | 10-3/4" |
| G | Opening Width | 4-1/2" |
| H | Length of Anchor | 2-5/8" |
| I | Angle of Anchor | 30° |

DURA SLOPE™ TRENCH DRAIN – PRE-SLOPED

Radius Coupling & Grates

Patent Pending

CHANNEL & TRENCH DRAINS

Designed specifically for draining 400-meter running tracks, Dura Slope™ Radius Couplings allow 3 degrees of deflection between trench drain sections, making an adjustable radius easily achievable for standard tracks and other curving applications.



Details

- 80'-120' radius
- Heavy-duty HDPE trench drain
- No Special tools required components snap into place
- Four depths available
- Grate options: standard & slotted
- Flexible radius coupling (patent pending)

Radius Coupling

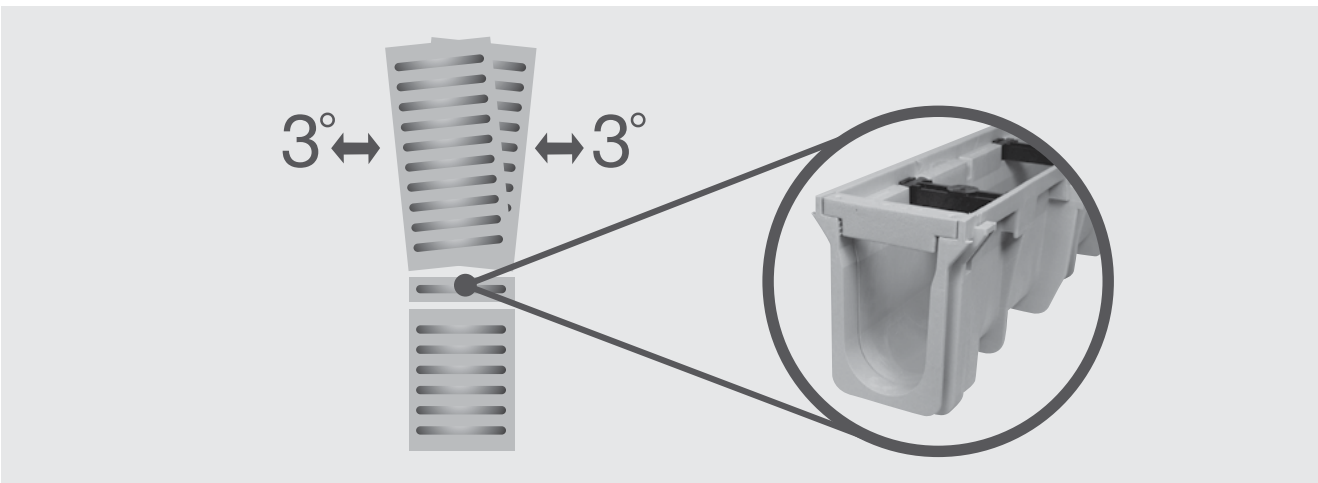

DURA SLOPE™ TRENCH DRAIN – PRE-SLOPED

EZ-Track™ Radius Coupling & Grates



| Part No. | Description | Color | Pkg. Qty. | Wt. Ea. (lbs.) | Product Class | Specifications |
|----------|--|------------|-----------|----------------|---------------|--|
| DSRC-097 | 6.35" Deep Neutral Dura Slope™ Radius Coupling | Light Gray | 6 | 0.81 | 25DS | 3 degree max. deflection per coupling. Minimum inside radius of 26". |
| DSRC-100 | 7.36" Deep Neutral Dura Slope™ Radius Coupling | Light Gray | 6 | 0.82 | 25DS | |
| DSRC-103 | 8.37" Deep Neutral Dura Slope™ Radius Coupling | Light Gray | 6 | 0.83 | 25DS | |
| DSRC-106 | 9.37" Deep Neutral Dura Slope™ Radius Coupling | Light Gray | 6 | 0.84 | 25DS | |
| DSRC | Dura Slope™ Radius Coupling | Light Gray | | | 25DS | |



| Part No. | Description | Color | Pkg. Qty. | Wt. Ea. (lbs.) | Product Class | Specifications |
|------------|---|------------|-----------|----------------|---------------|---|
| DS-660MG | 1.25" Plastic Slotted Radius Coupling Grate | White | 6 | 0.15 | 25DS | Structural Foam Polyolefin Radius Coupling Channel Grate with UV inhibitor. Open surface area 1.88 square inches per grate. 5.75 GPM per grate. |
| DS-661MG | 1.25" Plastic Slotted Radius Coupling Grate | Dark Gray | 6 | 0.15 | 25DS | |
| DS-661LGMG | 1.25" Plastic Slotted Radius Coupling Grate | Light Gray | 6 | 0.15 | 25DS | |
| DS-662MG | 1.25" Plastic Slotted Radius Coupling Grate | Green | 6 | 0.15 | 25DS | |
| DS-663MG | 1.25" Plastic Slotted Radius Coupling Grate | Black | 6 | 0.15 | 25DS | |
| DS-664MG | 1.25" Plastic Slotted Radius Coupling Grate | Sand | 6 | 0.15 | 25DS | |
| DS-665MG | 1.25" Plastic Slotted Radius Coupling Grate | Brick Red | 6 | 0.15 | 25DS | |



| Part No. | Description | Color | Pkg. Qty. | Wt. Ea. (lbs.) | Product Class | Specifications |
|------------|--|------------|-----------|----------------|---------------|---|
| DS-681LGMG | 1.25" Plastic Standard Radius Coupling Grate (no slot) | Light Gray | 6 | 0.16 | 25DS | Solid Structural Foam Polyolefin Radius Coupling Channel Grate with UV inhibitor. |

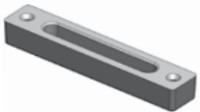

| Part No. | Description | Color | Pkg. Qty. | Wt. Ea. (lbs.) | Product Class | Specifications |
|----------|--|-------|-----------|----------------|---------------|---|
| DS-232MG | 1.25" Ductile Iron Radius Coupling Grate | Black | 6 | 0.93 | 25DS | Ductile Iron Radius Coupling Channel Grate. Open surface area 1.88 square inches per grate. 5.75 GPM per grate. |



| Part No. | Description | Color | Pkg. Qty. | Wt. Ea. (lbs.) | Product Class | Specifications |
|----------|--|-------|-----------|----------------|---------------|--|
| DS-226MG | 1.25" Perforated Stainless Steel Radius Coupling Grate | Steel | 6 | 0.25 | 25DS | Stainless Steel Radius Coupling Channel Grate. Open surface area 0.86 square inches per grate. 2.63 GPM per grate. |



| Part No. | Description | Color | Pkg. Qty. | Wt. Ea. (lbs.) | Product Class | Specifications |
|----------|--|-------|-----------|----------------|---------------|--|
| DS-221MG | 1.25" Galvanized Steel Radius Coupling Grate | Steel | 6 | 0.33 | 25DS | Galvanized Steel Coupling Channel Grate. Open surface area 1.31 square inches per grate. 4.01 GPM per grate. |

DURA SLOPE™ TRENCH DRAIN – PRE-SLOPED

Dura Slope™ System Profiles

CHANNEL & TRENCH DRAINS

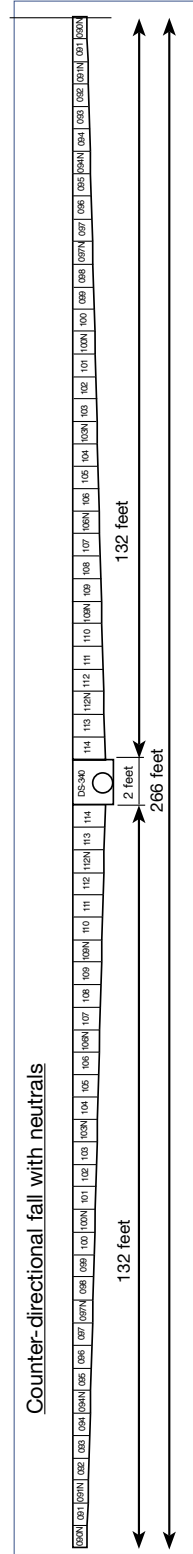
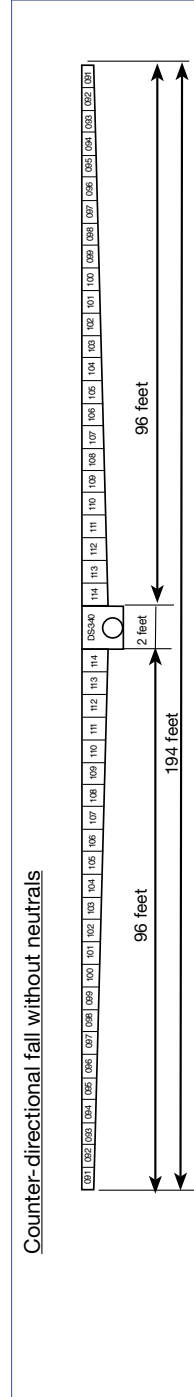
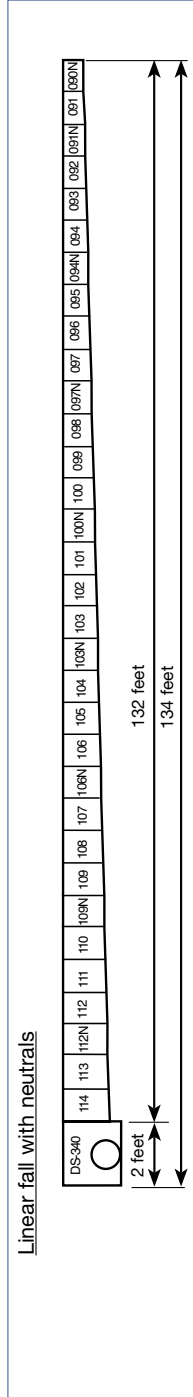
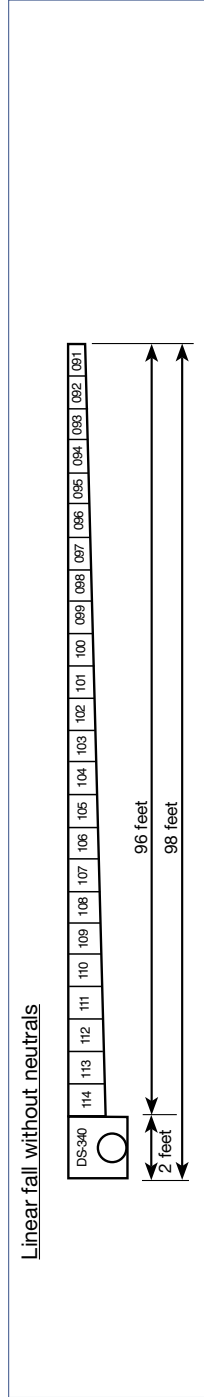
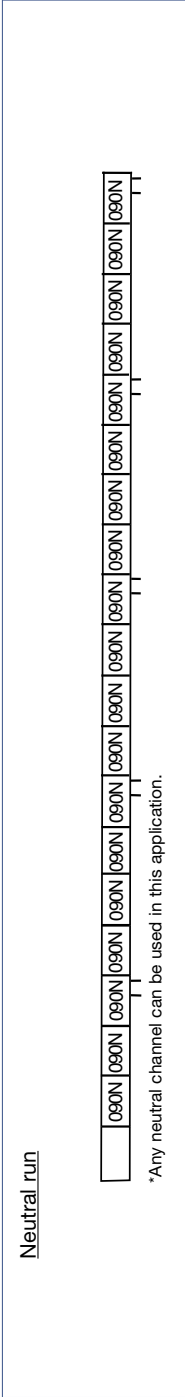

Note: Drawings are not to scale. See previous pages for actual product dimensions.

LOAD RECOMMENDATION GUIDE

NDS Class A

- Loads of 1-60 psi.
- Recommended for pedestrians, bicycles and wheelchair traffic.



NDS Class B

- Loads of 61-175 psi.
- Recommended for medium-duty pneumatic tire traffic, autos and light trucks at speeds less than 20 m.p.h.



NDS Class C

- Loads of 176-325 psi.
- Recommended for heavy-duty pneumatic tire forklifts and tractor-trailers at speeds less than 20 m.p.h., H-20 rated.



NDS Class D

- Loads of 326-575 psi.
- Recommended for heavy-duty hard tire forklifts at speeds less than 20 m.p.h., H-20 rated.



Notes: Some installations may require a concrete collar to meet load rating. Load ratings are based on encasing product in concrete. Product must be installed using NDS instructions.

Cast iron grates will oxidize over time and rust, forming an iron-oxide patina. The iron-oxide layer begins red-orange in color and ages to a deep, rich brown. This patina is tightly adhered and protects the iron beneath it from further oxidation. Iron grates with a rust patina are structurally sound and will last for decades.

Visit [ndspro.com](https://www.ndspro.com) for complete installation specifications, guidelines & details.

FILCOTEN® by NDS®

A Heavyweight When it Comes to Features

FILCOTEN® by NDS® combines smart engineering and smart materials to provide a superior trench drain suitable for handling a high load capacity. Combining the features of a stable concrete channel with the strength, durability and environmental-friendliness of fiber-reinforced concrete, FILCOTEN® by NDS® is the ideal choice for a wide variety of sites and applications.

Applications

Because FILCOTEN® by NDS® can handle a high load capacity, it is especially suitable for installation in industrial areas such as factories, garages and parking lots. With its sleek design it can easily be used in public places like railway stations, and pedestrian or residential areas. reinforced concrete, FILCOTEN® by NDS® is the ideal choice for a wide variety of sites and applications.

Product Features & Benefits

- Temperature, frost and UV resistant. Less contraction and expansion and longer product life.
- Product impact stability. Less susceptible to cracking and breaking during transport and installation.
- 100% recyclable/0% harmful substances. Sustainable solution without VOCs or heavy-metal residue that can leach into the ground. Qualifies for LEED credits.
- Non-flammable. Manufactured without resins, FILCOTEN® is rated A1, non-combustible.
- Monolithic adhesion. Free from de-molding agents, FILCOTEN® bonds securely with the surrounding concrete.

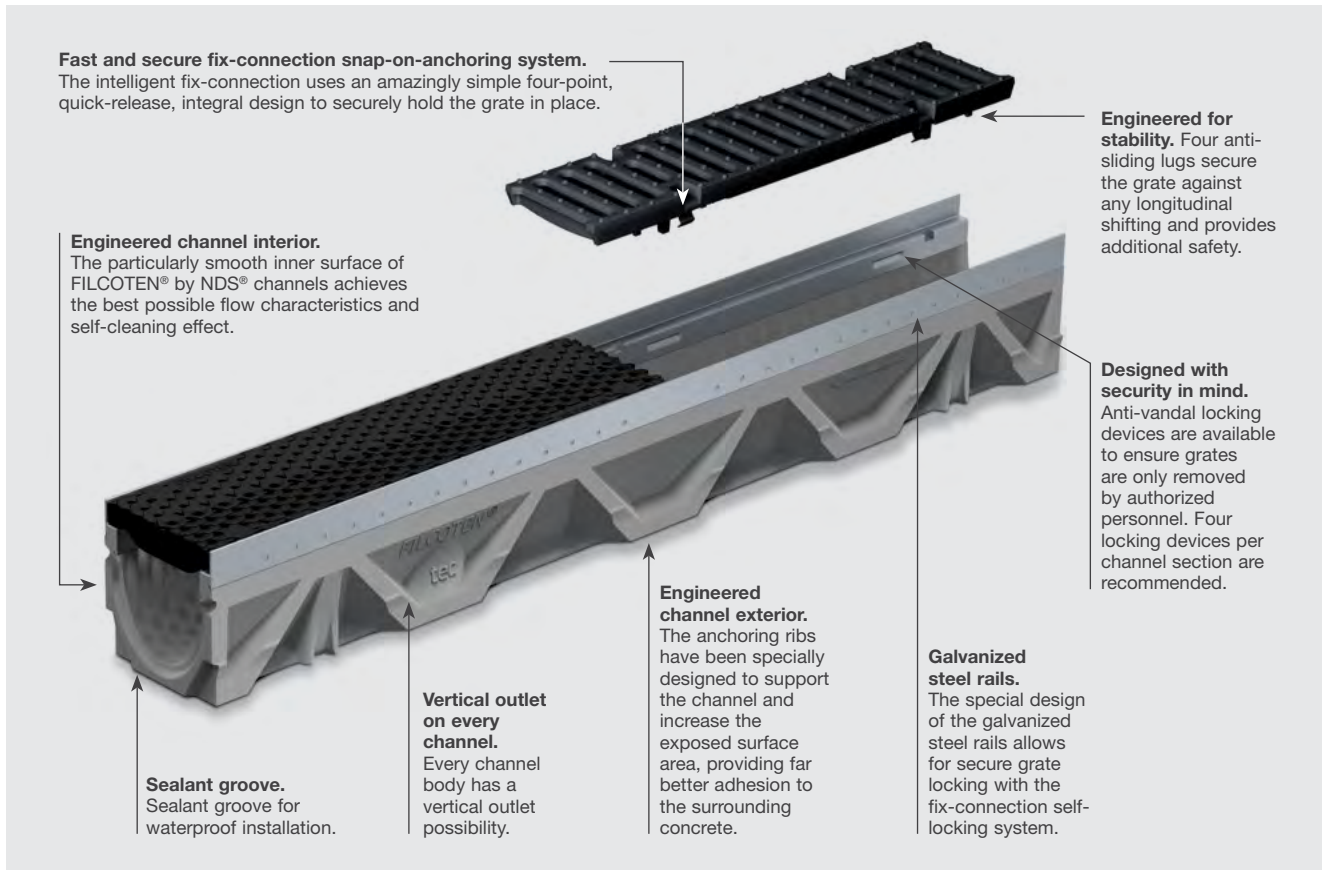

FILCOTEN® by NDS®

4" FILCOTEN® TEC V 100 Trench Drain

Tech V 100 Galvanized Steel Trench Drain

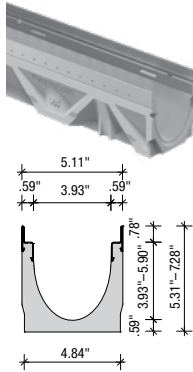

| Part No. | Description | Material | Carton Qty. | Weight Ea. (lbs.) | Length Ea. (in.) | Product Class |
|----------|---|-----------------|-------------|-------------------|------------------|---------------|
| 10410200 | FILCOTEN Tec V 100 Channel 0 without slope | Galvanized Rail | 30 | 28.88 | 39.37 | 25FC |
| 10410201 | FILCOTEN Tec V 100 Channel 1 with .5% slope | Galvanized Rail | 24 | 29.32 | 39.37 | 25FC |
| 10410202 | FILCOTEN Tec V 100 Channel 2 with .5% slope | Galvanized Rail | 24 | 30.20 | 39.37 | 25FC |
| 10410203 | FILCOTEN Tec V 100 Channel 3 with .5% slope | Galvanized Rail | 24 | 30.86 | 39.37 | 25FC |
| 10410204 | FILCOTEN Tec V 100 Channel 4 with .5% slope | Galvanized Rail | 24 | 31.75 | 39.37 | 25FC |
| 10410205 | FILCOTEN Tec V 100 Channel 5 with .5% slope | Galvanized Rail | 24 | 32.63 | 39.37 | 25FC |
| 10410206 | FILCOTEN Tec V 100 Channel 6 with .5% slope | Galvanized Rail | 24 | 33.51 | 39.37 | 25FC |
| 10410207 | FILCOTEN Tec V 100 Channel 7 with .5% slope | Galvanized Rail | 24 | 34.29 | 39.37 | 25FC |
| 10410208 | FILCOTEN Tec V 100 Channel 8 with .5% slope | Galvanized Rail | 24 | 35.05 | 39.37 | 25FC |
| 10410209 | FILCOTEN Tec V 100 Channel 9 with .5% slope | Galvanized Rail | 24 | 35.94 | 39.37 | 25FC |
| 10410210 | FILCOTEN Tec V 100 Channel 10 with .5% slope | Galvanized Rail | 24 | 36.82 | 39.37 | 25FC |
| 10410261 | FILCOTEN Tec V 100 Channel 5-0 without slope | Galvanized Rail | 24 | 33.07 | 39.37 | 25FC |
| 10410262 | FILCOTEN Tec V 100 Channel 10-0 without slope | Galvanized Rail | 24 | 37.26 | 39.37 | 25FC |
| 10410211 | FILCOTEN Tec V NW 100 No. 11, with Galvanized Steel Edge, 0,5% slope | Galvanized Rail | 15 | 29.54 | 39.37 | 25FC |
| 10410212 | FILCOTEN Tec V NW 100 No. 12, with Galvanized Steel Edge, 0,5% slope | Galvanized Rail | 15 | 31.09 | 39.37 | 25FC |
| 10410213 | FILCOTEN Tec V NW 100 No. 13, with Galvanized Steel Edge, 0,5% slope | Galvanized Rail | 15 | 32.63 | 39.37 | 25FC |
| 10410214 | FILCOTEN Tec V NW 100 No. 14, with Galvanized Steel Edge, 0,5% slope | Galvanized Rail | 15 | 33.95 | 39.37 | 25FC |
| 10410215 | FILCOTEN Tec V NW 100 No. 15, with Galvanized Steel Edge, 0,5% slope | Galvanized Rail | 15 | 35.05 | 39.37 | 25FC |
| 10410216 | FILCOTEN Tec V NW 100 No. 16, with Galvanized Steel Edge, 0,5% slope | Galvanized Rail | 15 | 36.16 | 39.37 | 25FC |
| 10410217 | FILCOTEN Tec V NW 100 No. 17, with Galvanized Steel Edge, 0,5% slope | Galvanized Rail | 15 | 37.04 | 39.37 | 25FC |
| 10410218 | FILCOTEN Tec V NW 100 No. 18, with Galvanized Steel Edge, 0,5% slope | Galvanized Rail | 15 | 38.36 | 39.37 | 25FC |
| 10410219 | FILCOTEN Tec V NW 100 No. 19, with Galvanized Steel Edge, 0,5% slope | Galvanized Rail | 15 | 39.68 | 39.37 | 25FC |
| 10410220 | FILCOTEN Tec V NW 100 No. 20, with Galvanized Steel Edge, 0,5% slope | Galvanized Rail | 15 | 40.79 | 39.37 | 25FC |
| 10410264 | FILCOTEN Tec V NW 100 No. 20-0, with Galvanized Steel Edge, without slope | Galvanized Rail | 15 | 41.23 | 39.37 | 25FC |

MTO: 6-7 week lead time

CHANNEL & TRENCH DRAINS

FILCOTEN® by NDS®

8" FILCOTEN® PRO V 200 Trench Drain

Pro 200 Galvanized Steel Trench Drain

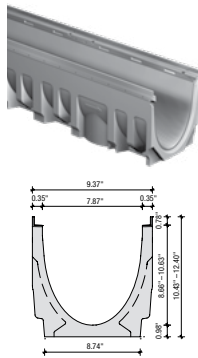

| Part No. | Description | Material | Carton Qty. | Weight Ea. (lbs.) | Length Ea. (in.) | Product Class |
|----------|--|-----------------|-------------|-------------------|------------------|---------------|
| 10620200 | FILCOTEN Pro V 200 Channel 0 without slope | Galvanized Rail | 9 | 97.00 | 39.37 | 25FC |
| 10620201 | FILCOTEN Pro V 200 Channel 1 with .5% slope | Galvanized Rail | 6 | 98.11 | 39.37 | 25FC |
| 10620202 | FILCOTEN Pro V 200 Channel 2 with .5% slope | Galvanized Rail | 6 | 100.31 | 39.37 | 25FC |
| 10620203 | FILCOTEN Pro V 200 Channel 3 with .5% slope | Galvanized Rail | 6 | 102.51 | 39.37 | 25FC |
| 10620204 | FILCOTEN Pro V 200 Channel 4 with .5% slope | Galvanized Rail | 6 | 104.72 | 39.37 | 25FC |
| 10620205 | FILCOTEN Pro V 200 Channel 5 with .5% slope | Galvanized Rail | 6 | 106.92 | 39.37 | 25FC |
| 10620206 | FILCOTEN Pro V 200 Channel 6 with .5% slope | Galvanized Rail | 6 | 109.13 | 39.37 | 25FC |
| 10620207 | FILCOTEN Pro V 200 Channel 7 with .5% slope | Galvanized Rail | 6 | 111.33 | 39.37 | 25FC |
| 10620208 | FILCOTEN Pro V 200 Channel 8 with .5% slope | Galvanized Rail | 6 | 113.54 | 39.37 | 25FC |
| 10620209 | FILCOTEN Pro V 200 Channel 9 with .5% slope | Galvanized Rail | 6 | 115.74 | 39.37 | 25FC |
| 10620210 | FILCOTEN Pro V 200 Channel 10 with .5% slope | Galvanized Rail | 6 | 117.95 | 39.37 | 25FC |
| 10620261 | FILCOTEN Pro V 200 Channel 5-0 without slope | Galvanized Rail | 6 | 108.30 | 39.37 | 25FC |
| 10620262 | FILCOTEN Pro V 200 Channel 10-0 without slope | Galvanized Rail | 6 | 118.83 | 39.37 | 25FC |
| 10620264 | FILCOTEN Pro V 200 Channel 20-0 without slope | Galvanized Rail | 6 | 138.23 | 39.37 | 25FC |
| 10620290 | FILCOTEN Pro V 200 Sump | Galvanized Rail | 6 | 105.82 | 19.69 | 25FC |
| 10620211 | FILCOTEN Pro V NW 200 No. 11, with Galvanized Steel Edge, 0,5% slope | Galvanized Rail | 6 | 199.42 | 39.37 | 25FC |
| 10620212 | FILCOTEN Pro V NW 200 No. 12, with Galvanized Steel Edge, 0,5% slope | Galvanized Rail | 6 | 203.51 | 39.37 | 25FC |
| 10620213 | FILCOTEN Pro V NW 200 No. 13, with Galvanized Steel Edge, 0,5% slope | Galvanized Rail | 6 | 207.59 | 39.37 | 25FC |
| 10620214 | FILCOTEN Pro V NW 200 No. 14, with Galvanized Steel Edge, 0,5% slope | Galvanized Rail | 6 | 211.68 | 39.37 | 25FC |
| 10620215 | FILCOTEN Pro V NW 200 No. 15, with Galvanized Steel Edge, 0,5% slope | Galvanized Rail | 6 | 215.77 | 39.37 | 25FC |
| 10620216 | FILCOTEN Pro V NW 200 No. 16, with Galvanized Steel Edge, 0,5% slope | Galvanized Rail | 6 | 219.86 | 39.37 | 25FC |
| 10620217 | FILCOTEN Pro V NW 200 No. 17, with Galvanized Steel Edge, 0,5% slope | Galvanized Rail | 6 | 223.95 | 39.37 | 25FC |
| 10620218 | FILCOTEN Pro V NW 200 No. 18, with Galvanized Steel Edge, 0,5% slope | Galvanized Rail | 6 | 228.03 | 39.37 | 25FC |
| 10620219 | FILCOTEN Pro V NW 200 No. 19, with Galvanized Steel Edge, 0,5% slope | Galvanized Rail | 6 | 232.12 | 39.37 | 25FC |
| 10620220 | FILCOTEN Pro V NW 200 No. 20, with Galvanized Steel Edge, 0,5% slope | Galvanized Rail | 6 | 236.21 | 39.37 | 25FC |

12" FILCOTEN® PRO V 300 Trench Drain

Pro V 300 Galvanized Steel Trench Drain

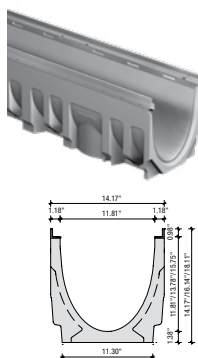

| Part No. | Description | Material | Carton Qty. | Weight Ea. (lbs.) | Length Ea. (in.) | Product Class |
|----------|---|-----------------|-------------|-------------------|------------------|---------------|
| 10630201 | FILCOTEN Pro V 300 Channel 1 with .5" slope | Galvanized Rail | 6 | 168.21 | 39.37 | 25FC |
| 10630202 | FILCOTEN Pro V 300 Channel 2 with .5" slope | Galvanized Rail | 6 | 171.08 | 39.37 | 25FC |
| 10630203 | FILCOTEN Pro V 300 Channel 3 with .5" slope | Galvanized Rail | 6 | 173.94 | 39.37 | 25FC |
| 10630204 | FILCOTEN Pro V 300 Channel 4 with .5" slope | Galvanized Rail | 6 | 176.81 | 39.37 | 25FC |
| 10630205 | FILCOTEN Pro V 300 Channel 5 with .5" slope | Galvanized Rail | 6 | 179.67 | 39.37 | 25FC |
| 10630206 | FILCOTEN Pro V 300 Channel 6 with .5" slope | Galvanized Rail | 6 | 182.54 | 39.37 | 25FC |
| 10630207 | FILCOTEN Pro V 300 Channel 7 with .5" slope | Galvanized Rail | 6 | 185.41 | 39.37 | 25FC |
| 10630208 | FILCOTEN Pro V 300 Channel 8 with .5" slope | Galvanized Rail | 6 | 188.27 | 39.37 | 25FC |
| 10630209 | FILCOTEN Pro V 300 Channel 9 with .5" slope | Galvanized Rail | 6 | 191.14 | 39.37 | 25FC |
| 10630210 | FILCOTEN Pro V 300 Channel 10 with .5" slope | Galvanized Rail | 6 | 194.00 | 39.37 | 25FC |
| 10630200 | FILCOTEN Pro V 300 Channel 0 without slope | Galvanized Rail | 6 | 166.67 | 39.37 | 25FC |
| 10630261 | FILCOTEN Pro V 300 Channel 5-0 without slope | Galvanized Rail | 6 | 181.00 | 39.37 | 25FC |
| 10630262 | FILCOTEN Pro V 300 Channel 10-0 without slope | Galvanized Rail | 6 | 195.33 | 39.37 | 25FC |
| 10630264 | FILCOTEN Pro V 300 Channel 20-0 without slope | Galvanized Rail | 6 | 240.30 | 39.37 | 25FC |
| 10630290 | FILCOTEN Crate Basin | Galvanized Rail | 2 | 273.37 | 25FC | 25FC |
| 10630211 | FILCOTEN Pro V NW 300 No. 11, with Galvanized Steel Edge, with 0,5% slope | Galvanized Rail | 6 | 199.42 | 39.37 | 25FC |
| 10630212 | FILCOTEN Pro V NW 300 No. 12, with Galvanized Steel Edge, with 0,5% slope | Galvanized Rail | 6 | 203.51 | 39.37 | 25FC |
| 10630213 | FILCOTEN Pro V NW 300 No. 13, with Galvanized Steel Edge, with 0,5% slope | Galvanized Rail | 6 | 207.59 | 39.37 | 25FC |
| 10630214 | FILCOTEN Pro V NW 300 No. 14, with Galvanized Steel Edge, with 0,5% slope | Galvanized Rail | 6 | 211.68 | 39.37 | 25FC |
| 10630215 | FILCOTEN Pro V NW 300 No. 15, with Galvanized Steel Edge, with 0,5% slope | Galvanized Rail | 6 | 215.77 | 39.37 | 25FC |
| 10630216 | FILCOTEN Pro V NW 300 No. 16, with Galvanized Steel Edge, with 0,5% slope | Galvanized Rail | 6 | 219.86 | 39.37 | 25FC |
| 10630217 | FILCOTEN Pro V NW 300 No. 17, with Galvanized Steel Edge, with 0,5% slope | Galvanized Rail | 6 | 223.95 | 39.37 | 25FC |
| 10630218 | FILCOTEN Pro V NW 300 No. 18, with Galvanized Steel Edge, with 0,5% slope | Galvanized Rail | 6 | 228.03 | 39.37 | 25FC |
| 10630219 | FILCOTEN Pro V NW 300 No. 19, with Galvanized Steel Edge, with 0,5% slope | Galvanized Rail | 6 | 232.12 | 39.37 | 25FC |
| 10630220 | FILCOTEN Pro V NW 300 No. 20, with Galvanized Steel Edge, with 0,5% slope | Galvanized Rail | 6 | 236.21 | 39.37 | 25FC |

FILCOTEN® by NDS®

FILCOTEN® TEC V 100 Grates

CHANNEL & TRENCH DRAINS

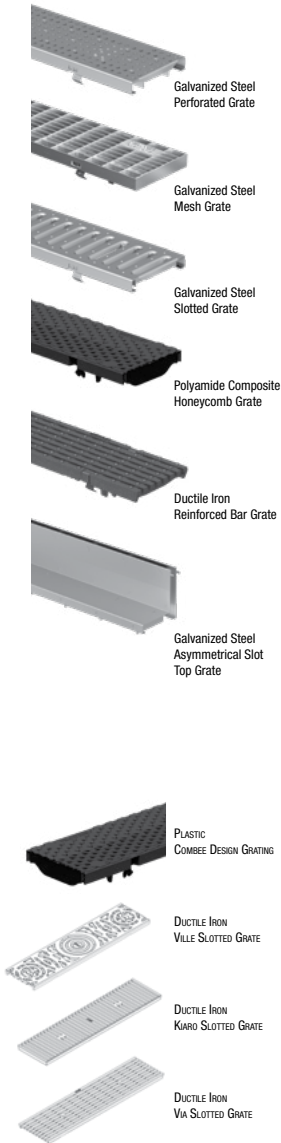

| Part No. | Description | Material | Carton Qty. | Weight Ea. (lbs.) | Length Ea. (in.) | Product Class |
|----------|--|------------------|-------------|-------------------|------------------|---------------|
| 17010105 | FILCOTEN 100 DI Slotted Grate Class E 19.69 in | Ductile Iron | 160 | 8.38 | 19.69 | 25FC |
| 17010106 | FILCOTEN 100 DI Bar Grate ADA/Heelproof Class C 19.69 in | Ductile Iron | 240 | 7.94 | 19.69 | 25FC |
| 17010110 | FILCOTEN 100 DI Bar Grate Class D 19.69 in | Ductile Iron | 240 | 7.50 | 19.69 | 25FC |
| 17010202 | FILCOTEN 100 G Slotted Grate Class A 39.37 in | Galvanized Steel | 240 | 3.31 | 39.37 | 25FC |
| 17010203 | FILCOTEN 100 G Slotted Grate Class A 19.69 in | Galvanized Steel | 120 | 1.76 | 19.69 | 25FC |
| 17010204 | FILCOTEN 100 G Perforated Grate Class A 39.37 in | Galvanized Steel | 120 | 4.19 | 39.37 | 25FC |
| 17010205 | FILCOTEN 100 G Perforated Grate Class A 19.69 in | Galvanized Steel | 120 | 2.20 | 19.69 | 25FC |
| 17010206 | FILCOTEN 100 G Slotted Grate Class C 39.37 in | Galvanized Steel | 240 | 9.92 | 39.37 | 25FC |
| 17010207 | FILCOTEN 100 G Slotted Grate Class C 19.69 in | Galvanized Steel | 120 | 4.85 | 19.69 | 25FC |
| 17010220 | FILCOTEN 100 G Mesh Grate Class B 39.37 in | Galvanized Steel | 120 | 6.17 | 39.37 | 25FC |
| 17010221 | FILCOTEN 100 G Mesh Grate Class B 19.69 in | Galvanized Steel | 80 | 3.09 | 19.69 | 25FC |
| 17010222 | FILCOTEN Tec Mesh Grating 1000/122/20, MW 30/10 | Galvanized Steel | 120 | 7.28 | 30.40 | 25FC |
| 17010223 | FILCOTEN Tec Mesh Grating 500/122/20, MW 30/10 | Galvanized Steel | 48 | 3.52 | 19.70 | 25FC |
| 17010228 | FILCOTEN 100 G Perforated Grate Class C 39.37 in | Galvanized Steel | 120 | 7.28 | 39.37 | 25FC |
| 17010229 | FILCOTEN 100 G Perforated Grate Class C 19.69 in | Galvanized Steel | 120 | 3.75 | 19.69 | 25FC |
| 17010402 | FILCOTEN 100 P Honeycomb Grate Class C 19.69 in | Plastic | 160 | 2.43 | 19.69 | 25FC |
| 17010401 | Combee Design Grating (Plastic) NW 100, 500/123/20, Class B 125 KN, With Fix-Locking-System | Plastic | 160 | 2.43 | 19.69 | 25DS |
| 17010180 | Ductile Iron Design Grate "Ville" NW 100, 500/122/25, Class E 600 KN (Tec, Pro)", Slot Width Maximum 8Mm | Ductile Iron | 240 | 11.46 | 19.69 | 25DS |
| 17010183 | Ductile Iron Design Grate "Kiaro" NW 100, 500/122/20, Class D 400 KN (Tec, Pro), Slot/Mesh Width 100X5.7mm | Ductile Iron | 240 | 9.48 | 19.69 | 25DS |
| 17010184 | Ductile Iron Design Grate "Via" NW 100, 500/122/20, Class D 400 KN (Tec, Pro), Slot/Mesh Width 29X6mm | Ductile Iron | 240 | 9.25 | 19.69 | 25DS |
| 17111204 | Slot Top Galvanized Steel NW100, asymmetric, SW 2 X 6 Mm, Class C 250 KN, 1000/123/133 Sh 110 | Galvanized Steel | 36 | 11.8 | 19.69 | 25FC |
| 17111205 | Slot Top Galvanized Steel NW100, asymmetric, SW 2 x 6 mm, Class C 250 KN, 500/123/133 SH 110 | Galvanized Steel | 24 | 5.98 | 19.69 | 25FC |
| 17111304 | Slot Top Stainless Steel NW100, asymmetric, SW 2 x 6 mm, Class C 250 KN, 1000/123/133 SH 110 | Stainless Steel | 36 | 11.8 | 19.69 | 25FC |
| 17111305 | Slot Top Stainless Steel NW100, asymmetric, SW 2 x 6 mm, Class C 250 KN, 500/123/133 SH 110 | Stainless Steel | 24 | 5.98 | 19.69 | 25FC |
| 17111206 | Maintenance unit Slot Top Galvanized Steel NW100, asymmetric, SW 2 x 6 mm, cl. C 250 KN | Galvanized Steel | | 11.02 | | 25FC |
| 17111306 | Maintenance unit Slot Top Stainless Steel NW100, asymmetric, SW 2 x 6 mm, cl. C 250 KN | Stainless Steel | | 11.02 | | 25FC |

See load recommendation guide page 87

FILCOTEN® by NDS®

FILCOTEN® PRO V 200 GRATES

CHANNEL & TRENCH DRAINS

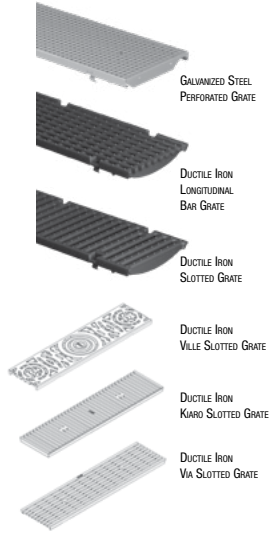

| Part No. | Description | Material | Carton Qty. | Weight Ea. (lbs.) | Length Ea. (in.) | Product Class |
|----------|---|------------------|-------------|-------------------|------------------|---------------|
| 17020104 | FILCOTEN 200 DI Bar Grate Class D 19.69 in | Ductile Iron | 98 | 16.53 | 19.69 | 25FC |
| 17020105 | FILCOTEN 200DI Bar Grate Class E 19.69 in | Ductile Iron | 98 | 18.96 | 19.69 | 25FC |
| 17020228 | FILCOTEN 200 G Perforated Grate Class C 39.27 in | Galvanized Steel | 60 | 29.76 | 39.37 | 25FC |
| 17020229 | FILCOTEN 200 G Perforated Grate Class C 19.69 in | Galvanized Steel | 28 | 14.77 | 19.69 | 25FC |
| 17020180 | Ductile Iron Design Grate "Ville" NW 200, 500/222/25, Class E 600 KN (Tec, Pro)", Slot Width Maximum 8mm | Ductile Iron | 98 | 23.81 | 19.69 | 25DS |
| 17020183 | Ductile Iron Design Grate "Kiaro" NW 200, 500/222/20, Class D 400 KN, (Tec, Pro), Slot/Mesh Width 200X5.7mm | Ductile Iron | 98 | 20.72 | 19.69 | 25DS |
| 17020184 | Ductile Iron Design Grate "Via" NW 200, 500/222/20, Class D 400 KN, (Pro), Slot/Mesh Width 29X6mm | Ductile Iron | 98 | 18.52 | 19.69 | 25DS |

See load recommendation guide page 87

FILCOTEN® PRO V 300 GRATES

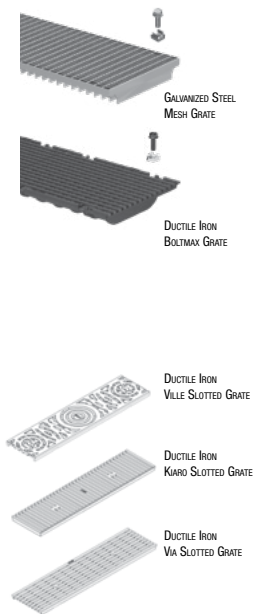

| Part No. | Description | Material | Carton Qty. | Weight Ea. (lbs.) | Length Ea. (in.) | Product Class |
|----------|--|------------------|-------------|-------------------|------------------|---------------|
| 17030103 | FILCOTEN 300 DI Bar Grate Class E 19.69 in | Ductile Iron | 30 | 39.46 | 19.69 | 25FC |
| | 32110 Bolt for Ductile Grate (Order 4 Per 1/2 meter Grate) | | | | | |
| 17030222 | FILCOTEN 300 G Mesh Grate Class C 39.37 in | Galvanized Steel | 30 | 50.93 | 39.37 | 25FC |
| | 32112 Bolt for Galvanized Mesh Grate (Order 4 Per Grate) | | | | | |
| 17030223 | Filcote 300 G Mesh Grate Class C 19.69 In | Galvanized Steel | 30 | 25.57 | 19.69 | 25FC |
| 17030180 | Ductile Iron Design Grate "Ville" NW 300, 500/347/25, Class E 600 KN (Pro) 4 Point Bolting-Device, ", Slot Width Maximum 8mm, Order Bolting Material Separately | Ductile Iron | 30 | 44.09 | 19.69 | 25DS |
| 17030183 | Ductile Iron Design Grate "Kiaro" NW 300, 500/347/25, Class D 400 KN, (Pro) 4 Point Bolting-Device, Slot/Mesh Width 300X5.7mm, Order Bolting Material Separately | Ductile Iron | 30 | 44.09 | 19.69 | 25DS |
| 17030184 | Ductile Iron Design Grate "Via" NW 300, 500/347/25, Class D 400 KN, (Pro) 4 Point Bolting-Device, Slot/Mesh Width 29X6mm, Order Bolting Material Separately | Ductile Iron | 30 | 38.58 | 19.69 | 25DS |

See load recommendation guide page 87

FILCOTEN® by NDS®

FILCOTEN® TEC V 100 Accessories

FILCOTEN Tec
Sump Unit 100

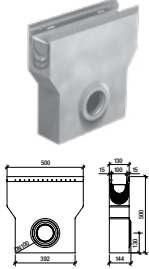

| Part No. | Description | Material | Weight Ea. (lbs.) | Product Class |
|-----------------|--|------------------|-------------------|---------------|
| 19011204 | FILCOTEN No Hub Bottom Outlet | Galvanized Steel | 0.66 | 25FC |
| 22515 | FILCOTEN 100 Silt Bucket for Sump | Plastic | 0.44 | 25FC |
| 32087 | FILCOTEN 100 Anti-Vandalism Locking Device | Stainless Steel | 0.22 | 25FC |
| 19011204 | FILCOTEN 100 Bottom Outlet | Galvanized Steel | 0.66 | 25FC |
| 19010230 | FILCOTEN 100 Closed End Cap | Galvanized Steel | 0.66 | 25FC |
| 19010231 | FILCOTEN 100 Open End Cap | Galvanized Steel | 0.66 | 25FC |
| 1901092 | FILCOTEN 100 Rebar Support | Galvanized Steel | 2.7 | 25FC |

FILCOTEN® PRO V 200 Accessories

FILCOTEN Pro
Sump Unit 200

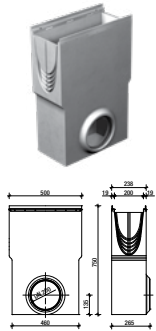

| Part No. | Description | Material | Weight Ea. (lbs.) | Product Class |
|----------|--|------------------|-------------------|---------------|
| 22512 | FILCOTEN 200 Silt Bucket for Sump | Plastic | 1.54 | 25FC |
| 32089 | FILCOTEN 200 Grate Vandal-Proof Device | Stainless Steel | 0.22 | 25FC |
| 70154 | FILCOTEN 8" Pipe Connector for Catch Basin | Plastic | 2.43 | 25FC |
| 19020216 | FILCOTEN 200 End Cap with Outlet | Galvanized Steel | 1.10 | 25FC |
| 19020230 | FILCOTEN Closed End Cap | Galvanized Steel | 0.88 | 25FC |
| 19020295 | FILCOTEN Step Connector Plate | Galvanized Steel | 0.44 | 25FC |
| 19020215 | FILCOTEN 200 Closed End Cap | Galvanized Steel | 0.88 | 25FC |
| 19020902 | FILCOTEN No Hub Bottom Outlet | Galvanized Steel | 2.20 | 25FC |
| 1902092 | FILCOTEN Rebar Support | Galvanized Steel | 1.8 | 25FC |

FILCOTEN® PRO V 300 Accessories

FILCOTEN Pro 300
Sump Kit with Silt Bucket

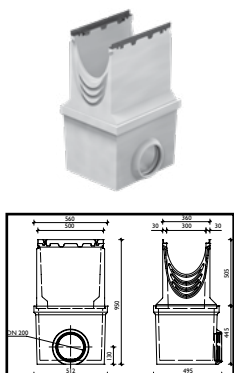

| Part No. | Description | Material | Weight Ea. (lbs.) | Product Class |
|----------|--|------------------|-------------------|---------------|
| 22213 | FILCOTEN 300 Silt Bucket for Sump | Galvanized Steel | 7.05 | 25FC |
| 32110 | FILCOTEN 300 Bolt and Nut for Locking | Galvanized Steel | 0.22 | 25FC |
| 19030213 | FILCOTEN 300 Closed End Cap | Galvanized Steel | 3.75 | 25FC |
| 19030214 | FILCOTEN 300 End Cap with Outlet | Galvanized Steel | 3.53 | 25FC |
| 19030290 | FILCOTEN 300 Catch Basin End Cap Connector | Galvanized Steel | 0.66 | 25FC |
| 19030295 | FILCOTEN 300 Step Connector Plate | Galvanized Steel | 0.88 | 25FC |
| 10630290 | FILCOTEN Catch Basin | Galvanized Rail | 273.37 | 25FC |
| 1903092 | FILCOTEN Rebar Support | Galvanized Steel | 2.4 | 25FC |

FILCOTEN® by NDS®

FILCOTEN® by NDS® System Profiles

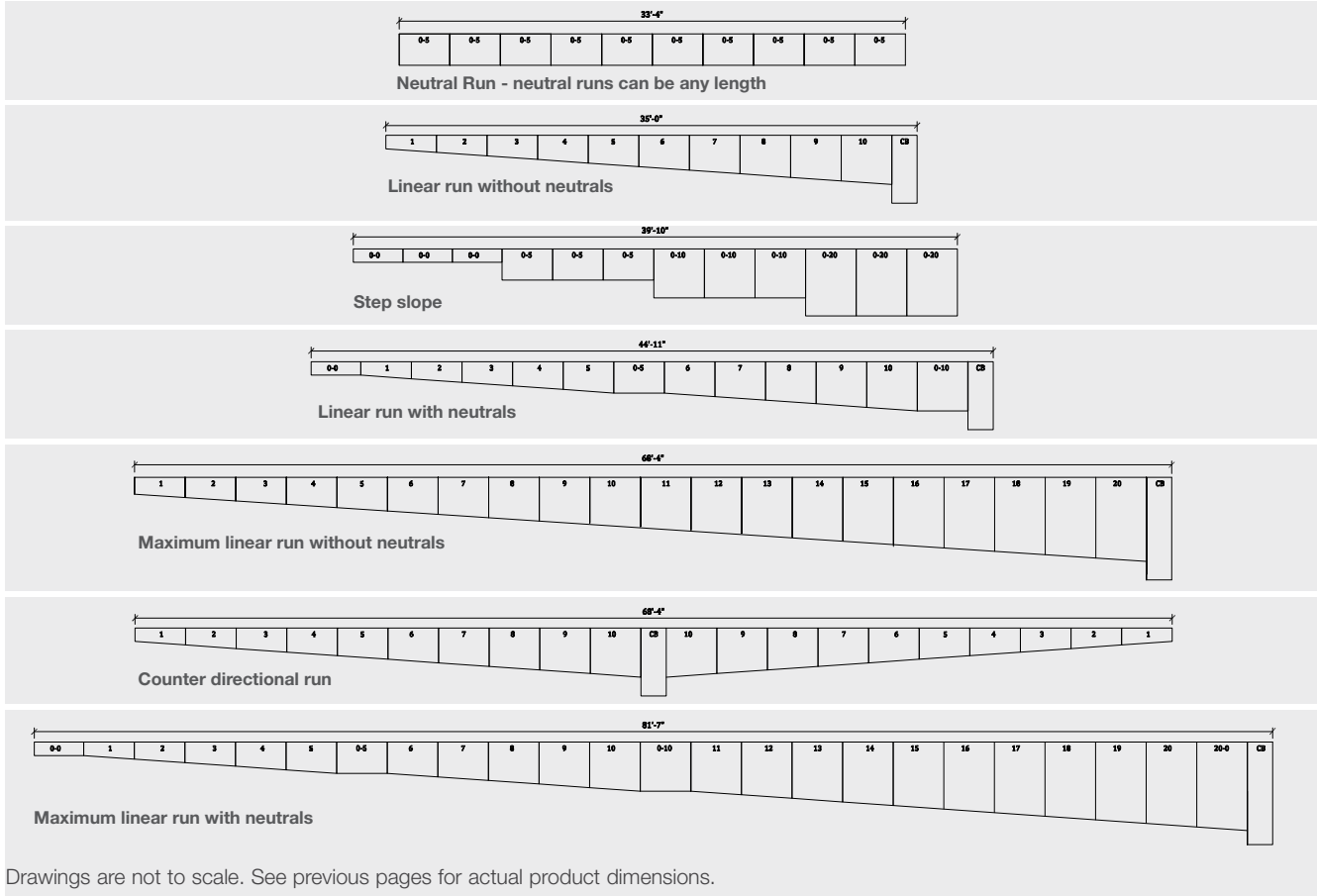

Drawings are not to scale. See previous pages for actual product dimensions.

The maximum run length using only sloped channels with a catch basin in the middle is 135'. The maximum run length with all slopes with 1 each of the neutrals and a catch basin in the middle would be 162'.

FILCOTEN® by NDS®

LOAD RECOMMENDATION GUIDE – According to EN1433 Standards

Class A

- Max Design Load: 3,372 lbs.
- Pedestrians
- Bicyclists
- Planted Areas



Class B

- Max Design Load: 28,100 lbs.
- Pedestrians
- Parking Lots
- Delivery Vehicles



Class C

- Max Design Load: 56,200 lbs.
- Curbs
- Road Shoulders
- Parking Lots



Class D

- Max Design Load: 89,920 lbs.
- Roadways
- Pedestrian Zones
- Parking Lots



Class E

- Max Design Load: 134,800 lbs.
- Industry
- Military
- High Wheel Loads

Notes: Some installations may require a concrete collar to meet load rating. Load ratings are based on encasing product in concrete. Product must be installed using NDS instructions.

Cast iron grates will oxidize over time and rust, forming an iron-oxide patina. The iron-oxide layer begins red-orange in color and ages to a deep, rich brown. This patina is tightly adhered and protects the iron beneath it from further oxidation. Iron grates with a rust patina are structurally sound and will last for decades.

Visit [ndspro.com](https://www.ndspro.com) for complete installation specifications, guidelines & details.

CHANNEL & TRENCH DRAINS PRODUCTS INDEX

CHANNEL & TRENCH DRAINS

| Part No. | Page | Part No. | Page | Part No. | Page | Part No. | Page | Part No. | Page |
|-----------|------------|-------------|------------|-----------|------|----------|------|----------|--------|
| 229 | 60, 64 | 661LG | 73 | 8002 | 56 | 32089 | 85 | 10630208 | 82 |
| 230 | 56, 59, 61 | 662 | 73 | 8003 | 56 | 32110 | 85 | 10630209 | 82 |
| 234 | 61 | 663 | 73 | 8301 | 56 | 70154 | 85 | 10630210 | 82 |
| 240 | 60 | 664 | 73 | 8302 | 56 | 1901092 | 85 | 10630211 | 82 |
| 241 | 60 | 665 | 73 | 8303 | 56 | 1902092 | 85 | 10630212 | 82 |
| 242 | 60 | 710 | 64 | 8371 | 56 | 1903092 | 85 | 10630213 | 82 |
| 243 | 60 | 712 | 64 | 8372 | 56 | 10410200 | 81 | 10630214 | 82 |
| 244 | 60 | 713 | 64 | 8373 | 56 | 10410201 | 81 | 10630215 | 82 |
| 245 | 61 | 714 | 64 | 8381 | 56 | 10410202 | 81 | 10630216 | 82 |
| 246 | 61 | 764 | 64 | 8382 | 56 | 10410203 | 81 | 10630217 | 82 |
| 247 | 61 | 800 | 66 | 8383 | 56 | 10410204 | 81 | 10630218 | 82 |
| 248 | 61 | 812 | 66 | 8461 | 56 | 10410205 | 81 | 10630219 | 82 |
| 249 | 61 | 813 | 66 | 8462 | 56 | 10410206 | 81 | 10630220 | 82 |
| 251 | 60 | 814 | 65 | 8463 | 56 | 10410207 | 81 | 10630261 | 82 |
| 252 | 60 | 815 | 65 | 8471 | 56 | 10410208 | 81 | 10630262 | 82 |
| 252CI | 60 | 816 | 65 | 8472 | 56 | 10410209 | 81 | 10630264 | 82 |
| 252GR | 60 | 817 | 65 | 8473 | 56 | 10410210 | 81 | 10630290 | 82, 85 |
| 252GY | 60 | 818 | 65 | 8481 | 56 | 10410211 | 81 | 17010105 | 83 |
| 252S | 60 | 819 | 65 | 8501 | 56 | 10410212 | 81 | 17010106 | 83 |
| 253 | 60 | 820 | 66 | 8502 | 56 | 10410213 | 81 | 17010110 | 83 |
| 253CI | 60 | 821 | 66 | 8503 | 56 | 10410214 | 81 | 17010180 | 83 |
| 253GR | 60 | 822 | 66 | 8511 | 56 | 10410215 | 81 | 17010183 | 83 |
| 253GY | 60 | 823 | 65 | 8512 | 56 | 10410216 | 81 | 17010184 | 83 |
| 253S | 60 | 824 | 65 | 8513 | 56 | 10410217 | 81 | 17010202 | 83 |
| 254 | 60 | 826 | 65 | 8601 | 56 | 10410218 | 81 | 17010203 | 83 |
| 400 | 60 | 828 | 65 | 8651 | 56 | 10410219 | 81 | 17010204 | 83 |
| 400-10 | 60 | 829 | 60, 65, 67 | 8652 | 56 | 10410220 | 81 | 17010205 | 83 |
| 400-10MTL | 60 | 830 | 68 | 8653 | 56 | 10410261 | 81 | 17010206 | 83 |
| 400-10WH | 60 | 831 | 68 | 9206 | 57 | 10410262 | 81 | 17010207 | 83 |
| 500 | 58 | 832 | 68 | 9206GKIT | 57 | 10410264 | 81 | 17010220 | 83 |
| 500S | 58 | 833 | 68 | 9206SKIT | 57 | 10620200 | 82 | 17010221 | 83 |
| 529 | 58, 59 | 834 | 68 | 9209 | 57 | 10620201 | 82 | 17010222 | 83 |
| 532 | 59 | 836 | 67 | 9209GRAY | 57 | 10620202 | 82 | 17010223 | 83 |
| 533 | 59 | 837 | 67 | 9209SAND | 57 | 10620203 | 82 | 17010228 | 83 |
| 540 | 58 | 838 | 67 | 9209WHITE | 57 | 10620204 | 82 | 17010229 | 83 |
| 541 | 58 | 840 | 69 | 9241 | 57 | 10620205 | 82 | 17010401 | 83 |
| 542 | 58 | 841 | 69 | 9242 | 57 | 10620206 | 82 | 17010402 | 83 |
| 543 | 58 | 843 | 69 | 9243 | 57 | 10620207 | 82 | 17020104 | 84 |
| 544 | 58 | 844 | 69 | 9247 | 57 | 10620208 | 82 | 17020105 | 84 |
| 546 | 59 | 846 | 58 | 9248 | 57 | 10620209 | 82 | 17020180 | 84 |
| 546S | 59 | 847 | 69 | 9250 | 57 | 10620210 | 82 | 17020183 | 84 |
| 547 | 59 | 849 | 69 | 9251 | 57 | 10620211 | 82 | 17020184 | 84 |
| 547S | 59 | 861 | 66 | 9252 | 57 | 10620212 | 82 | 17020228 | 84 |
| 548 | 59 | 862 | 66 | 9253 | 57 | 10620213 | 82 | 17020229 | 84 |
| 548S | 59 | 864 | 65 | 9261 | 57 | 10620214 | 82 | 17030103 | 84 |
| 550 | 59 | 864DISPLAY | 65 | 9262 | 57 | 10620215 | 82 | 17030180 | 84 |
| 551 | 58 | 864GRTL | 65 | 9263 | 57 | 10620216 | 82 | 17030183 | 84 |
| 552B | 58 | 864GRTLDISP | 65 | 9270 | 57 | 10620217 | 82 | 17030184 | 84 |
| 553PB | 58 | 885 | 69 | 9301 | 57 | 10620218 | 82 | 17030222 | 84 |
| 554 | 58 | 888 | 67 | 9302 | 57 | 10620219 | 82 | 17030223 | 84 |
| 554CI | 58 | 2301 | 61 | 9303 | 57 | 10620261 | 82 | 17111201 | 74 |
| 554GR | 58 | 2351 | 61 | 9371 | 57 | 10620262 | 82 | 17111202 | 74 |
| 554GY | 58 | 2361 | 61 | 9372 | 57 | 10620264 | 82 | 17111204 | 83 |
| 554S | 58 | 2371 | 61 | 9373 | 57 | 10620290 | 82 | 17111205 | 83 |
| 555 | 58 | 2381 | 61 | 9381 | 57 | 10630200 | 82 | 17111206 | 83 |
| 555CI | 58 | 5300 | 59 | 9382 | 57 | 10630201 | 82 | 17111281 | 74 |
| 555GR | 58 | 5303 | 59 | 9383 | 57 | 10630202 | 82 | 17111304 | 83 |
| 555GY | 58 | 5370 | 59 | 13399 | 74 | 10630203 | 82 | 17111305 | 83 |
| 555S | 58 | 5372 | 59 | 22213 | 85 | 10630204 | 82 | 17111306 | 83 |
| 629 | 75 | 5380 | 59 | 22512 | 85 | 10630205 | 82 | 19010230 | 85 |
| 660 | 73 | 5383 | 59 | 22515 | 85 | 10630206 | 82 | 19010231 | 85 |
| 661 | 73 | 8001 | 56 | 32087 | 85 | 10630207 | 82 | 19011204 | 85 |

PERMEABLE PAVERS

PERMEABLE PAVERS

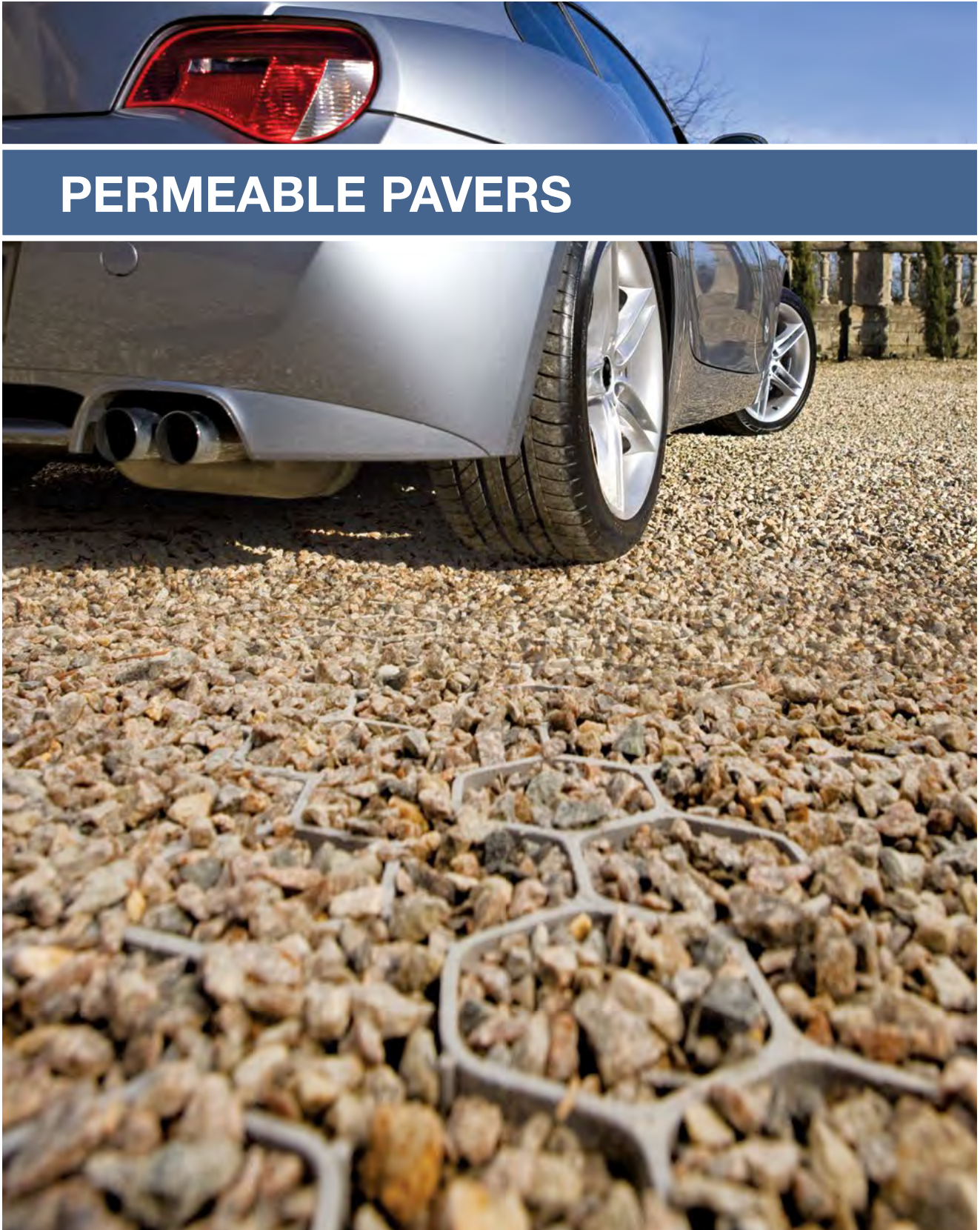

NDS Permeable Pavers provide an alternative solution to traditional paving methods. Creating a strong grass or gravel surface that can support heavy vehicles, they maintain permeable surface areas, eliminating or reducing stormwater runoff.

Benefits

Greatest Compressive Strength*. Offering a high load-bearing capacity, NDS Permeable Pavers feature hexagonal cells that connect together to form a flexible grid system capable of handling significant structural loads.

Easy Installation. EZ Roll™ products come in large rolls that are easily placed and clipped together. Tufftrack™ features an integrated easy to assemble clip, that greatly reduces installation time.

Reduced Maintenance. Less expensive to maintain over time than traditional hardscaping and reduces demands put on landscape drainage systems.

Environmentally Friendly. NDS Permeable Pavers contribute to LEED credits and are made of up to 100% recycled plastic.

*Compare the strength of NDS Permeable Pavers to the competition.



TUFFTRACK™ GRASS PAVER

PERMEABLE PAVERS



Tufftrack™ Grass Pavers are the strongest paver on the market that works for both grass and gravel applications. Manufactured in rigid 24" square panels it offers maximum strength and stabilization for support of heavy vehicles like fire trucks.

Tufftrack™ Grass Pavers are 24" x 24" rigid panels featuring a clip fastener designed for fast installation that easily connects without extra pieces or tools. The Tufftrack Grass Paver has a combined series of 120 nested hexagonal cells per paver cell with 12 connecting clips. This unique combination provides superior stability and durability.

Ideal Applications

- Fire lanes
- Truck & cart wash-down areas
- Parking lots
- Emergency vehicle access roads
- RV & boat access and parking
- Overflow parking lots
- Truck maintenance and equipment yards
- Residential driveways



Specifications

Tufftrack™ is available in:
24" x 24" panels, 1.5" thick

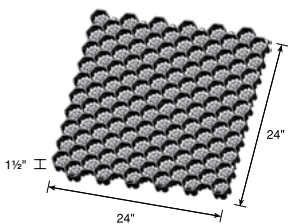

Empty cells have a compressive strength of **86,563 psf**

Cells filled with wet soil have a compressive strength of 400,000 psf

Product ships in 24 in. squares for easy layout

Unique tongue & groove clips are easier to install

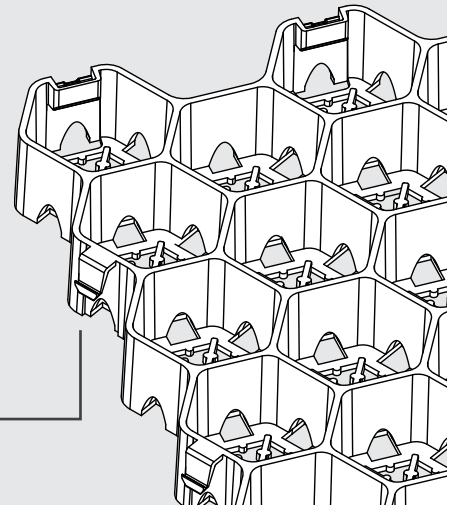

| Part No. | Description | Color | Pkg. Qty./ Pallet Qty. | Wt. Ea. Lbs. | Product Class |
|----------|-----------------------------------|-------|------------------------|--------------|---------------|
| TT-24 | 24" x 24" Tufftrack® Grass Pavers | Black | 1/132 | 4.35 | 55GP |

EZ ROLL™ & HONOR ROLL™ GRASS PAVERS



EZ Roll™ Grass Pavers feature hexagonal cells that protect the root zone and prevent soil compaction, allowing healthy grass to thrive in areas that would traditionally have impervious hardscaping installed.

EZ Roll™ Grass Pavers are honeycombed rolled grass pavers that are comprised of 24" x 24" x 1" panels. The product is made of up to 100% recycled HDPE material with UV inhibitors. Panels are available in pre-assembled rolls, and multiple panels and rolls easily connect together with a series of locking joints. EZ Roll Grass Pavers have an ultimate compression load rating of 53,683 psf "empty."

Ideal Applications

- Golf cart paths
- Residential driveways
- Parking lots
- Roadway shoulders
- Emergency vehicle or service access roads – Also an effective solution for erosion control on slopes and in swales

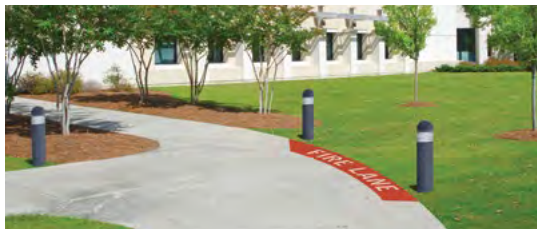

Honor Roll™ Pavers are ideal for long, linear applications next to curbs, medians.

Specifications

EZ Roll™ Grass Paver

3.96 ft. x 24 ft. rolls – 95.01 square feet total

3.96 ft. x 152 ft. rolls – 601.6 square feet total

(150 ft. +/- 2 ft. on the length and 3.96 ft. +/- 1/2 in. for width using 76 panel pairs total)



Honor Roll™

13 in. x 150 ft. rolls – 158.3 square feet total

18 in. x 150 ft. rolls – 226.5 square feet total

Empty cells have a compressive strength of **53,683 psf**

Cells filled with wet soil have a compressive strength of **400,000 psf**

Product ships in large rolls for easy rollout

Easy to connect locking tabs on sides and ends

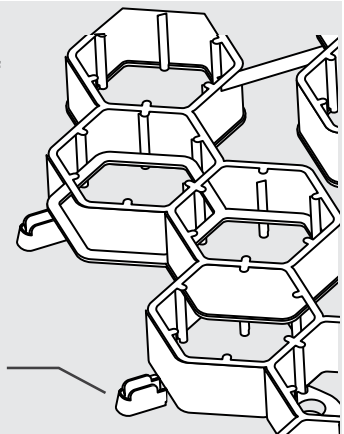

| Part No. | Description | Color | Pallet Qty. | Wt. Ea. Lbs. | Product Class |
|-----------|--|-------|-------------|--------------|---------------|
| EZ4X24 | EZ Roll™ Grass Pavers, 3.96 ft. x 24 ft. roll, 95.01 sf total | Black | 6 | 55.44 | 55GP |
| EZ4X150 | EZ Roll™ Grass Pavers, 3.96 ft. x 152 ft. roll, 601.6 sf total | Black | 1 | 360.00 | 55GP |
| EZ13X150 | Honor Roll™ Pavers, 13 in. wide roll* | Black | 1 | 172.49 | 55GP |
| EZ1.5X150 | Honor Roll™ Pavers, 18 in. wide roll* | Black | 1 | 172.49 | 55GP |

*MTO 3-4 weeks

EZ ROLL™ GRAVEL PAVERS



EZ Roll™ Gravel Pavers preserve permeability and help maintain the look and functionality of a gravel road. Made with 100% recycled materials, they also minimize surface water runoff and present an attractive and sustainable alternative to traditional concrete or asphalt.

PERMEABLE PAVERS

NDS EZ Roll™ Gravel Pavers are a high quality injection molded, plastic rolled gravel paver structure of linked and nested honeycomb cells. The product is made from up to 100% recycled HPDE plastic with UV inhibitors. Pavers come in pre-assembled rolls, and a lateral snap lock latching system securely connects paver panels together to create an integral paver mat. Pavers must have an ultimate compression load rating of 53,683 psf (empty).

Ideal Applications

- Golf cart paths
- Service roads
- Jogging tracks
- Bike paths
- RV & boat access & parking
- Residential driveways
- Parking lots
- Roadway shoulders
- Firelanes
- Emergency vehicle access roads
- Truck maintenance and equipment yards
- Effective solution for erosion control on slopes & in swales

Specifications

A continuous piece of geotextile fabric prevents migration of base and infill materials yet is porous to allow for the filtration of stormwater runoff.

Available in four colors for design flexibility. Crushed or decomposed granite, limestone and pea gravel are just some of the fill material options that work well with EZ Roll™ Gravel.



EZ Roll™ Gravel Paver

3.87 ft. x 149 ft. rolls – 577 square feet total

(149 ft. +/- 2 ft. on the length and 3.87 ft. +/- 1/2 in. for width using 76 panel pairs total)

Gravel Paver Stake (GPSTAKE)

Ships with EZ Roll™



Empty cells have a compressive strength of **53,683 psf**

Cells filled with 3/8" Gravel have a compressive strength of **500,000 psf**

Product ships in large rolls for easy rollout

Easy to connect locking tabs on sides and ends

| Part No. | Description | Color | Pkg. Qty. | Wt. Ea. Lbs. | Product Class |
|----------|--|-----------|-----------|--------------|---------------|
| GP4X150 | EZ Roll™ Gravel Pavers, 3.87 ft. x 149 ft. roll, 577 sf total | Black | 1 | 360.00 | 55GP |
| GP4X150G | EZ Roll™ Gravel Pavers, 3.87 ft. x 149 ft. roll, 577 sf total* | Gray | 1 | 360.00 | 55GP |
| GP4X150R | EZ Roll™ Gravel Pavers, 3.87 ft. x 149 ft. roll, 577 sf total* | Brick Red | 1 | 360.00 | 55GP |
| GP4X150T | EZ Roll™ Gravel Pavers, 3.87 ft. x 149 ft. roll, 577 sf total* | Tan | 1 | 360.00 | 55GP |
| GPSTAKE | EZ Roll™ Gravel Paver Stake | Raw Steel | 40 | 23.40 | 55GP |

*MTO 3-4 weeks

EZ MARKER™ PARKING DELINEATORS



Used with EZ Roll™ Grass and Gravel Pavers, NDS **EZ Marker™** is a modular solution to outlining driving lanes, parking stalls, and fire lanes. After the pavers have been unrolled, pinned, and secured, EZ Marker™ snaps into the appropriate empty cells to outline whatever pattern necessary to properly direct vehicular traffic.

EZ Marker™ Parking Delineators increase safety and organization by strategically directing parking lot traffic. Delineators are a great way to guide motorists around hazards and to their final parking destination. Used in conjunction with EZ Roll™ Grass and Gravel Permeable Pavers they provide a simple and effective solution for managing parking lot traffic. EZ Marker™ is durable, tamper-resistant and built to last. Available in various colors to suit any traffic need including grass or gravel parking and fire line access.

Specifications

- 2.7" hexagonal shape
- 0.40" profile above paver grade
- Molded polypropylene, impact copolymer
- 300 PSI class "C" compressive strength
- Easy clip-in installation
- Self-cleaning: Raised dome design prevents debris from sticking



| Part No. | Description | Color |
|------------|-----------------------------|--------|
| EZMARKER | EZ Roll™ Parking Delineator | White |
| EZMARKER-B | EZ Roll™ Parking Delineator | Blue |
| EZMARKER-R | EZ Roll™ Parking Delineator | Red |
| EZMARKER-Y | EZ Roll™ Parking Delineator | Yellow |

For Permeable Paver Technical Information, Refer to Technical Specification documents at ndspro.com/specifications

PERMEABLE PAVERS PRODUCTS INDEX

| Part No. | Page | Part No. | Page | Part No. | Page | Part No. | Page | Part No. | Page |
|-----------|------|------------|------|------------|------|----------|------|----------|------|
| EZ1.5X150 | 93 | EZ13X150 | 93 | EZMARKER-R | 95 | GP4X150G | 94 | GPSTAKE | 94 |
| EZ4X24 | 93 | EZMARKER | 95 | EZMARKER-Y | 95 | GP4X150R | 94 | TT-24 | 92 |
| EZ4X150 | 93 | EZMARKER-B | 95 | GP4X150 | 94 | GP4X150T | 94 | | |

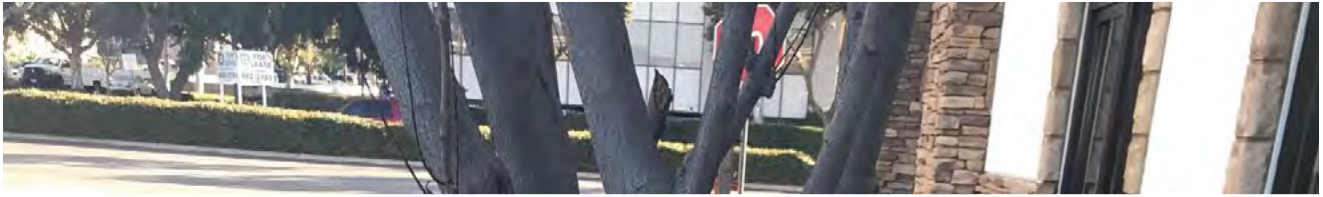

LANDSCAPE



LANDSCAPE

ROOT BARRIER PANELS



Root barrier products direct root growth from shrubs and trees downward, dramatically decreasing the roots' potential to clash with and penetrate nearby hardscapes, walls, or building foundations. The use of NDS root barriers for residential and non-residential landscapes protects many communities and homeowners against the high cost of reparations due to cracks in foundations and buckled sidewalks and driveways.

Modular EP Series Root Barrier Panels

EP Series Root Barrier Panels are made from injection molded High Impact Polypropylene (HIPP) with a unique factory installed joiner strip that eases installation. EP Series Panels include a "T" top edge to prevent root overgrowth and an Anchor Lock™ external flange at the base to lock panels in the ground. Suitable for all planting installations, EP Series Root Barrier Panels are available in 12", 18", 24" and 36" depths.



Quad Clip™ Joiner Strips



Reinforcing Ribs

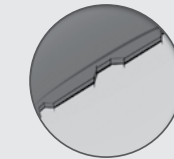
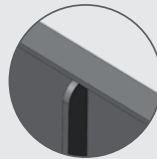

Anchor Lock™

Specifications

EP Series Root Barrier Panels by NDS include factory installed independent joiner strips. Each Barrier is a minimum of 0.090 inches thick and is made of up to 50% post consumer High Impact Polypropylene (HIPP) with U.V. inhibitors to ensure longevity. Barrier Panels have 1/2" raised vertical ribs running perpendicular to the panel and are 6" on center. All EP Series Panels feature a 3/8" wide "T" top edge and an external ground anchoring base flange that is 1/8" in width.

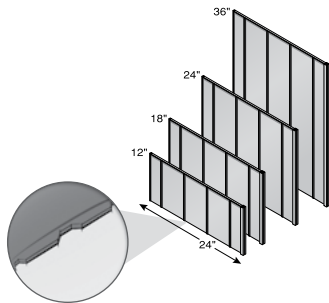

| Part No. | Description | Color | Pkg. Qty. | Wt. Ea. Lbs. | Product Class |
|----------|------------------------------|-------|-----------|--------------|---------------|
| EP-1250 | 12" x 24" Root Barrier Panel | Black | 25 | 1.80 | 50LP |
| EP-1850 | 18" x 24" Root Barrier Panel | Black | 25 | 1.56 | 50LP |
| EP-2450 | 24" x 24" Root Barrier Panel | Black | 25 | 2.12 | 50LP |
| EP-3650 | 36" x 24" Root Barrier Panel | Black | 25 | 3.20 | 50LP |

Includes 1 Joiner Strip per panel

Recommended Installations

| Surround Application: | Linear/Root Pruning Application: |
|---|---|
| Panels placed around root ball, at a sufficient distance to allow proper backfill of materials. | Panels placed directly adjacent to the hardscape being protected. |

ROOT BARRIER PANELS

Root Barrier Sheet Material

Manufactured from durable HDPE, Root Barrier Sheet Material creates a water and root barrier to prevent costly damage to pavements, roads, and building foundations caused by water and roots. The 20-foot-long sheets of material are ideal for linear style planting applications, and are equally suited for individual tree planting use. Root Barrier Sheet Material is available in 12", 18", and 24" depths to meet a variety of applications.

LANDSCAPE

- A - Finished Grade
- B - 3"- 4" of 3/4" Gravel
- C - Amended Soil
- D - Sheet Material

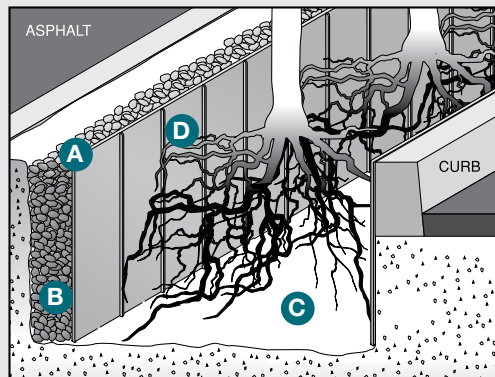

Specifications

Root Barrier Sheet Material by NDS is manufactured from up to 50% recycled HDPE with U.V. inhibitors with a thickness of 0.040 - 0.060". Barriers feature vertically integrated and flared molded 90° root-deflecting ribs that protrude 1/2" from wall and are placed 6-8" apart. A root impervious molded end provides easy assembly using staples or a sealant design to bind to HDPE (a dual-sided solvent-based tape).

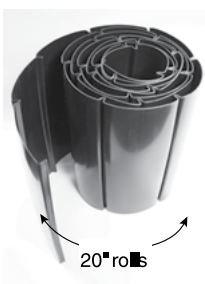

| Part No. | Description | Color | Pkg. Qty. | Wt. Ea. Lbs. | Product Class |
|----------|-------------------|-------|-----------|--------------|---------------|
| SM-1220 | 12" x 20 ft. Roll | Black | 1 | 10.00 | 50LP |
| SM-1820 | 18" x 20 ft. Roll | Black | 1 | 14.00 | 50LP |
| SM-2420 | 24" x 20 ft. Roll | Black | 1 | 18.00 | 50LP |
| SM-3620 | 36" x 20 ft. Roll | Black | 1 | 22.00 | 50LP |

Recommended Installations

Surround Application:

Cut desired length of molded roll material. Connect the ends by overlapping two 6" sections with the leading rib cut directly down the middle. If using a sealant to seal the ends, utilize a dual-sided solvent-based tape (like that sold by Tuff Industries, Inc.). Install by placing the Sheet Material around root ball at a sufficient distance to allow proper backfill – the vertical integrated root-deflecting ribs should always be facing the root ball.

Linear/Root Pruning Application:

Cut desired length of molded roll material and install directly adjacent to hardscape being protected

ROOT BARRIER PLANTERS

Pre-molded, one piece, tapered root control planter made of Structural Foam High Impact Polyethylene (SFHIPP) for superior strength. The ribbed interior wall design guides tree roots down and out of the flanged base. Advantages include the elimination of measuring, cutting, gluing or assembly of panels. Installation is further simplified in that units fit into a 30" augured hole.

Specifications

Root Barrier Planter by NDS has a top diameter of 22", a bottom diameter of 30", a height of 18" and a wall thickness of 0.250". Planter is one piece and molded of up to 505 post consumer Structural Foam High Impact Polyethylene (SFHIPP) material with U.V. inhibitors. Root Barrier Planter has a 3/4" inward facing top edge, a 1" external facing ground anchoring base flange with 1/2" high raised vertical ribs at ± 6" intervals on the interior wall.

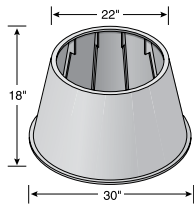

| Part No. | Description | Color | Pkg. Qty. | Wt. Ea. Lbs. | Product Class |
|----------|------------------------------|-------|-----------|--------------|---------------|
| FI-15 | Tapered Root Barrier Planter | Black | 1 | 13.00 | 50LP |

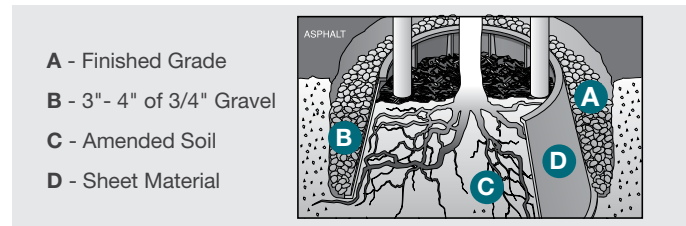

Recommended Installations

Patio Trees:

Root Barrier Planter is ideal for a 15 gallon tree or a 16" root ball whose trunk caliper will not exceed 14" in diameter at maturity.

Street Tree Use:

Root Barrier Planter is the preferred product for use in city sidewalk cutouts or where trees are completely surrounded by hardscape.

TRUNK PROTECTOR

Used around the base of trees to prevent damage from lawnmowers, edgers, and string trimmers. The coiled shape allows it to expand with the growth of the tree. It is vented, which permits the tree to breathe and it is notched at the base to accommodate root flare. NDS Trunk Protector is colored to help it blend with the natural shade of the tree. Each unit fits up to a 4" caliper tree; multiple units may be used for larger trees.

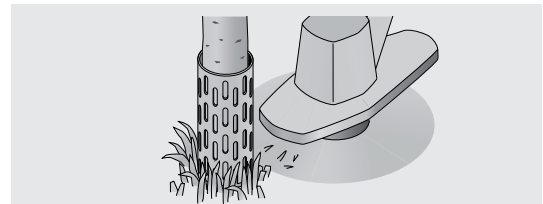

Specifications

Trunk Protector by NDS is made of Low Density linear Polyethylene (LDLPE) material with U.V. inhibitors to insure longevity. Trunk Protector measures 8" high, 12" wide and ± 0.050" thick. Slotted vents are 1" high by 1/4" wide, creating a serrated lower edge on the bottom row.

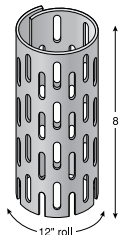

| Part No. | Description | Color | Pkg. Qty. | Wt. Ea. Lbs. | Product Class |
|----------|-----------------|-------|-----------|--------------|---------------|
| TP-128 | Trunk Protector | Gray | 50 | 0.16 | 50LP |

Recommended Installations

Any tree planted in lawn or brush areas where mowing or trimming equipment may cause contact with tree trunks.

PROFESSIONAL IRRIGATION

PROFESSIONAL IRRIGATION



Introducing NDS® Professional Irrigation, a line of efficient drip and micro-irrigation products that offers complete, system-oriented watering solutions for the green industry. Product offering includes drip emitters, multi-outlet bubblers, micro-sprays, misters, tubing, fittings, stakes, regulators, valves, and filters.

POINT OF CONNECTION

Hose Bib Timer



| Part No. | Description | Color | Bag Qty./Box Qty. | Wt. Each (lbs.) | Product Class |
|----------|------------------------|-------|-------------------|-----------------|---------------|
| A 675CT | Battery Hose Bib Timer | Blue | 1/10 | 1.25 | 21DI |

Universal Conversion Kit & Cap Off

Patented



| Part No. | Description | Color | Bag Qty./Box Qty. | Wt. per 100 (lbs.) | Product Class |
|------------|--|-------|-------------------|--------------------|---------------|
| FR2 17-710 | Spray-to-Drip Conversion Kit 17mm-.710 | Black | 1 | – | 21DI |
| CAP POP/5 | Universal Cap-Off | Black | 5 | – | 21DI |
| CAP POP/25 | Universal Cap-Off | Black | 25 | – | 21DI |

Pressure-Regulating Wye Filter



| Part No. | Description | Color | Bag Qty./Box Qty. | Wt. per 100 (lbs.) | Product Class |
|----------|---|-------|-------------------|--------------------|---------------|
| PRYF 30 | Pressure Regulating Filters, 3/4" MPT, 30 PSI, 200 mesh | Black | 1/5 | 0.25 | 21DI |
| PRYF 40 | Pressure Regulating Filters, 1" MPT, 40 PSI, 200 mesh | Black | 1/5 | 0.30 | 21DI |

Control Zone Kits



| Part No. | Description | Bag Qty./Box Qty. | Wt. Each (lbs.) | Product Class |
|---------------|---|-------------------|-----------------|---------------|
| CZK 100-30 | 1" Control Zone Kit with 30 PSI Pressure Regulating Filter | 1/10 | 1.26 | 21DI |
| CZK 100-30F | 1" Control Zone Kit with 30 PSI Pressure Regulating Filter and Flow Control | 1/10 | 1.30 | 21DI |
| CZK 100-40 | 1" Control Zone Kit with 40 PSI Pressure Regulating Filter | 1/10 | 1.26 | 21DI |
| CZK 100-40F | 1" Control Zone Kit with 40 PSI Pressure Regulating Filter and Flow Control | 1/10 | 1.30 | 21DI |
| CZK 100-40VB1 | 1" Control Zone Kit with 40 PSI Pressure Regulating Filter in 10"x15" Green Valve Box | 1/25 | 5.35 | 21DI |

Drip Zone Kit

| Part No. | Description | Bag Qty./Box Qty. | Wt. per 100 (lbs.) | Product Class |
|-------------|---|-------------------|--------------------|---------------|
| DZK 700/710 | Drip Zone Kit: 150 Mesh Filter, 30 PSI Regulator, 1-8 gpm Flow (Fits .680" – .710" OD Tubing Outlet 1" and 3/4" MIPT Inlet) | 1/10 | 0.76 | 21DI |



| Features | Benefits |
|---------------------------------|---|
| All parts in one kit | No need to purchase or source additional parts |
| Easy installation | Saves time |
| Fits .680" – .710" OD PE Tubing | One kit used for a wide range of PE tubing, saving the need to have additional products |
| 3/4" or 1" Inlet | Easily installed on 3/4" or 1" discharges |
| 150 Mesh Filter | Prevents debris entering drip system |
| 30 PSI Regulator | Will operate a wide range of micro products |

POINT OF CONNECTION

Y Strainers

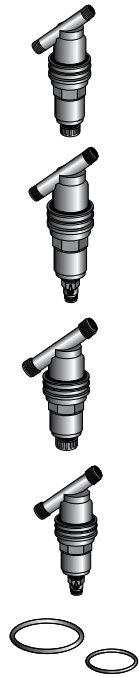

| Part No. | Description | Color | Bag Qty./ Box Qty. | Wt. per 100 (lbs.) | Product Class |
|----------|--|-------|-----------------------|-----------------------|------------------|
| YS 75 | "Y" Filter, 3/4" MIPT, with 150 Mesh Polyester Screen Element (10 gpm Capacity, 150 PSI Max. Pressure) | Black | 1/50 | 33.1 | 21DI |
| YSS 75 | "Y" Filter, 3/4" MIPT, with 150 Mesh Stainless Steel Screen Element (10 gpm Capacity, 150 PSI Max. Pressure) | Black | 1/50 | 34.1 | 21DI |
| YSV 75 | "Y" Filter, 3/4" MIPT, with 150 Mesh Polyester Screen Element, Includes Flush Valve (10 gpm Capacity, 150 PSI Max. Pressure) | Black | 1/50 | 35.6 | 21DI |
| YSVS 75 | "Y" Filter, 3/4" MIPT, with 150 Mesh Stainless Steel Screen Element, Includes Flush Valve (10 gpm Capacity, 150 PSI Max. Pressure) | Black | 1/50 | 36.5 | 21DI |
| YS 100 | "Y" Filter, 1" MIPT, with 150 Mesh Polyester Screen Element, (10 gpm Capacity, 150 PSI Max. Pressure) | Black | 1/50 | 36.6 | 21DI |
| YSS 100 | "Y" Filter, 1" MIPT, with 150 Mesh Stainless Steel Screen Element, (10 gpm Capacity, 150 PSI Max. Pressure) | Black | 1/50 | 36.8 | 21DI |
| YSV 100 | "Y" Filter, 1" MIPT, with 150 Mesh Polyester Screen Element, Includes Flush Valve (10 gpm Capacity, 150 PSI Max. Pressure) | Black | 1/50 | 39.0 | 21DI |
| YSVS 100 | "Y" Filter, 1" MIPT, with 150 Mesh Stainless Steel Screen Element, Includes Flush Valve (10 gpm Capacity, 150 PSI Max. Pressure) | Black | 1/50 | 39.7 | 21DI |
| OR 136 | Replacement O-Ring for YS Filter Housing | Black | 10/100 | .03 | 21DI |
| OR 027 | Replacement O-Ring for YS Filter Element | Black | 10/100 | .01 | 21DI |

Pressure Regulators

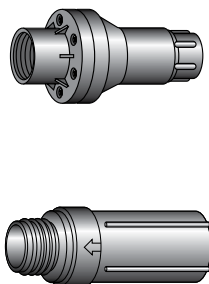

| Part No. | Description | Color | Bag Qty./ Box Qty. | Wt. per 100 (lbs.) | Product Class |
|----------|--|-------|-----------------------|-----------------------|------------------|
| PR 20 | 20 PSI, 3/4" FIPT Pressure Regulator (0.1 – 8 gpm Flow Range) | Black | 10/50 | 31.0 | 21DI |
| PR 30 | 30 PSI, 3/4" FIPT Pressure Regulator (0.1 – 8 gpm Flow Range) | Black | 10/50 | 31.0 | 21DI |
| PRM 30 | 30 PSI, 3/4" FIPT Pressure Regulator (2 – 20 gpm Flow Range) | Black | 10/50 | 31.0 | 21DI |
| PRP 20 | 20 PSI, Pipe Thread, Pressure Regulator (3/4" FPT in x 3/4" MPT out, .2 to 10 gpm) | Black | 10/50 | 15.3 | 21DI |
| PRP 30 | 30 PSI, Pipe Thread, Pressure Regulator (3/4" FPT in x 3/4" MPT out, .2 to 10 gpm) | Grey | 10/50 | 15.3 | 21DI |

POINT OF CONNECTION

Pressure Regulators (continued)

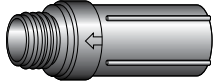

| Part No. | Description | Color | Bag Qty./ Box Qty. | Wt. per 100 (lbs.) | Product Class |
|----------|---|-------|-----------------------|-----------------------|------------------|
| PRP 40 | 40 PSI, Pipe Thread, Pressure Regulator (3/4" FHT in x 3/4" MHT out, .2 to 10 gpm) | Blue | 10/50 | 15.3 | 21DI |
| PRH 20 | 20 PSI, Hose Thread, Pressure Regulator (3/4" FHT in x 3/4" MHT out, .2 to 10 gpm) | Black | 10/50 | 15.3 | 21DI |
| PRH 30 | 30 PSI, Hose Thread, Pressure Regulator (3/4" FHT in x 3/4" MHT out, .2 to 10 gpm) | Grey | 10/50 | 15.3 | 21DI |
| PRH 40 | 40 PSI, Hose Thread, Pressure Regulator (3/4" FHT in x 3/4" MHT out, .2 to 10 gpm) | Blue | 10/50 | 15.3 | 21DI |

Filters and Replacement Screens



| Part No. | Description | Color | Bag Qty./ Box Qty. | Wt. per 100 (lbs.) | Product Class |
|------------|--|-------|-----------------------|-----------------------|------------------|
| SSTF 150 | Stainless Steel Screen – 150 Mesh (Replacement for FTEE 150 Filter) | Black | 10/50 | 1.8 | 21DI |
| SP 150 | Polyester Screen – 150 Mesh (Replacement for YS 75, YSV 75, YS 100, YSV 100 Filter) | Black | 5/20 | 3.7 | 21DI |
| SSS 150 | Stainless Steel Screen (Replacement for YSS 75, YSVS 75, YSS 100 and YSVS 100 Filter) | Black | 5/20 | 4.3 | 21DI |
| SW 75 | 3/4" Filter Washer (30 Mesh, Stainless Steel) | Green | 100/1,000 | 0.5 | 21DI |
| SW 50 | 1/2" Filter Washer (100 Mesh, Stainless Steel) | Black | 100/1,000 | 0.4 | 21DI |
| SSPRAY 200 | Stainless Steel Filter Screen for PRYF 30 & 40 | Black | 1/20 | 3.5 | 21DI |

PROFESSIONAL IRRIGATION

Swing Pipe Fittings



| Part No. | Description | Color | Bag Qty./ Box Qty. | Wt. per 100 (lbs.) | Product Class |
|----------|---------------------------------------|-------|-----------------------|-----------------------|------------------|
| FPA-0500 | 1/2" Male MPT x Spiral Barbed Adapter | Black | 50/500 | 1.6 | 42LS |
| FPA-0750 | 3/4" Male MPT x Spiral Barbed Adapter | Black | 50/500 | 2.0 | 42LS |
| FPE-0500 | 1/2" Male MPT x Spiral Barbed Elbow | Black | 50/500 | 2.2 | 42LS |
| FPE-0750 | 3/4" Male MPT x Spiral Barbed Elbow | Black | 50/500 | 2.6 | 42LS |
| FPC-0490 | 1/2" Spiral Barbed Coupler | Black | 50/500 | 1.4 | 42LS |

Use with Flexee or Super Flexee pipe. (See page 137)
Swing Riser Assemblies available. (See page 106)

POINT OF CONNECTION

Swing Joints

PROFESSIONAL IRRIGATION

PVC Sch. 80
Swing Assembly
GRAY



PVC Sch. 40
Swing Assembly
WHITE



| Part No. | Description | Color | Pkg. Qty. | Product Class | Specifications |
|-----------------------------------|-------------------------------|-------|-----------|---------------|----------------------------------|
| PVC Sch. 80 Swing Assembly | | | | | |
| TSA-0500-BB | 1/2" (BSP x BSP) | Gray | 60 | 42TS | PVC Rated @ 315 PSI @ 72°F |
| TSA-0500-ST | 1/2" S x M | Gray | 60 | 42TS | |
| TSA-0500-TT | 1/2" M x M | Gray | 60 | 42TS | |
| TSA-0750-BB | 3/4" (BSP x BSP) | Gray | 50 | 42TS | |
| TSA-0750-CT | 3/4" SCKT x MIPT | Gray | 50 | 42TS | |
| TSA-0750-LT | 3/4" LONG SPGT/MIPT | Gray | 50 | 42TS | |
| TSA-0750-SC | 3/4" S x S | Gray | 50 | 42TS | |
| TSA-0750-ST | 3/4" S x M | Gray | 50 | 42TS | |
| TSA-0750-TT | 3/4" M X M | Gray | 50 | 42TS | |
| TSA-1000-BB | 1" (BSP x BSP) | Gray | 25 | 42TS | |
| TSA-1000-ST | 1" S x M | Gray | 25 | 42TS | |
| TSA-1000-TT | 1" M x M | Gray | 25 | 42TS | |
| TSA-1250-TT | 1-1/4" M x M | Gray | 15 | 42TS | |
| TSA-1500-SA | 1-1/2" S x ACME | Gray | 15 | 42TS | |
| TSA-1500-ST | 1-1/2" S x M | Gray | 15 | 42TS | |
| TSA-1500-TT | 1-1/2" M x M | Gray | 15 | 42TS | |
| TSA-1512-ST | 1-1/2" X 1-1/4" SPIGOT x MIPT | Gray | 15 | 42TS | |
| TSA-1512-TT | 1-1/2" X 1-1/4" (MIPT x MIPT) | Gray | 15 | 42TS | |
| PVC Sch. 40 Swing Assembly | | | | | |
| WSA-0500-TT | 1/2" (T x T) | White | 60 | 42TS | PVC Rated @ 315 PSI @ 72°F |
| WSA-0750-TT | 3/4" (T x T) | White | 50 | 42TS | |
| WSA-1000-TT | 1" (T x T) | White | 25 | 42TS | |
| WSA-1250-TT | 1-1/4" (T x T) | White | 25 | 42TS | |

Economy Swing Joints

PVC/Poly Econo
Swing Joints



| Part No. | Description | Color | Pkg. Qty. | Product Class | Specifications |
|------------------------------------|-------------------------------|-------|-----------|---------------|--------------------------|
| PVC/Poly Econo Swing Joints | | | | | |
| TSE-0500-6 | 1/2" x 6" MIPT x MIPT | Black | 100 | 42TS | Rated @ 70 PSI @ 72°F |
| TSE-0500-6R | 1/2" x 6" MIPT x MIPT | Black | 50 | 42TS | |
| TSE-0500-12 | 1/2" x 12" MIPT x MIPT | Black | 50 | 42TS | |
| TSE-0500-12R | 1/2" x 12" MIPT x MIPT | Black | 50 | 42TS | |
| TSE-0507-6 | 1/2" x 3/4" x 6" MIPT x MIPT | Black | 50 | 42TS | |
| TSE-0507-6R | 1/2" x 3/4" x 6" MIPT x MIPT | Black | 50 | 42TS | |
| TSE-0507-12 | 1/2" x 3/4" x 12" MIPT x MIPT | Black | 50 | 42TS | |
| TSE-0750-6 | 3/4" x 6" MIPT x MIPT | Black | 50 | 42TS | |
| TSE-0750-6R | 3/4" x 6" MIPT x MIPT | Black | 50 | 42TS | |
| TSE-0750-12 | 3/4" x 12" MIPT x MIPT | Black | 50 | 42TS | |
| TSE-0750-12R | 3/4" x 12" MIPT x MIPT | Black | 50 | 42TS | |

"R" Indicates Additional Inlet Elbow

POINT OF CONNECTION

Landscape Sprinkler Products

| | Part No. | Description | Ctn. Qty. | Product Class | Specifications |
|--|--|--|-----------|---------------|-----------------------|
| Cutoff Risers  | Cut-Off Risers | | | | |
| | FCO-0500 | 1/2" x 6" Flex Cut-Off | 50 | 42LS | Rated @ 70 PSI @ 72°F |
| | FCO-0750-R | 1/2" x 3/4" x 6" MIPT x MIPT Flex-Cutoff | 500 | 42LS | |
| | MCO-0500 | 1/2" x 6" MIPT x MIPT Multi-Cutoff | 500 | 42LS | |
| | MCO-0500-12 | 1/2" x 12" MIPT x MIPT Multi-Cutoff | 250 | 42LS | |
| | MCO-0750 | 3/4" x 6" MIPT x MIPT Multi-Cutoff | 500 | 42LS | |
| | MCO-0750-R | 1/2" x 3/4" x 6" MIPT x MIPT Multi-Cutoff | 500 | 42LS | |
| Flex Risers  | Flex Risers | | | | |
| | FR-0500-4 | 1/2" x 4" MIPT x MIPT Flex Riser | 100 | 42LS | Rated @ 70 PSI @ 72°F |
| | FR-0500-4F | 1/2" x 4" MPT x FPT Flex Riser | 100 | 42LS | |
| | FR-0500-6 | 1/2" x 6" MIPT x MIPT Flex Riser | 100 | 42LS | |
| | FR-0500-6F | 1/2" x 6" MIPT x FIPT Flex Riser | 100 | 42LS | |
| | FR-0750-6 | 3/4" x 6" MIPT x MIPT Flex Riser | 50 | 42LS | |
| | FR-1000-7 | 1" x 7" MIPT x MIPT Flex Riser | 25 | 42LS | |
| Cutoff Riser Extension  | Cutoff Riser Extension | | | | |
| | CRE-0500-3 | 1/2" x 3" FIPT x MIPT Cutoff Riser Extension | 200 | 42LS | Rated @ 70 PSI @ 72°F |
| CRE-0750-4 | 3/4" x 4" FIPT x MIPT Cutoff Riser Extension | 200 | 42LS | | |
| Street Elbows  | Street Elbows | | | | |
| | STL-0500 | 1/2" 90° FIPT x MIPT Street Elbow | 1600 | 42LS | Rated @ 70 PSI @ 72°F |
| STL-0750 | 3/4" 90° FIPT x MIPT Street Elbow | 1000 | 42LS | | |
| Swing Pipe Fittings  | Swing Pipe Fittings | | | | |
| | FPA-0500 | Swing Pipe Adapter .490BARB x 1/2" | 50 | 42LS | |
| | FPA-0750 | 3/4" Swing Pipe Adapter | 250 | 42LS | |
| | FPC-0490 | .49" Swing Pipe Connector | 250 | 42LS | |
| | FPE-0500 | 1/2" Swing Pipe Elbow | 400 | 42LS | |
| | FPE-0500F | 1/2" Swing Pipe Elbow FPT x Spiral Barb | 400 | 42LS | |
| | FPE-0750 | 3/4" Swing Pipe Elbow | 250 | 42LS | |
| FPT-0500 | 1/2" Swing Pipe Tee | 500 | 42LS | | |
| Shrub Adapter  | Shrub Adapter | | | | |
| | SAM-0500 | 1/2" Male Sprinkler Adapter | 50 | 42LS | Rated @ 70 PSI @ 72°F |

PROFESSIONAL IRRIGATION

Backwater Valves

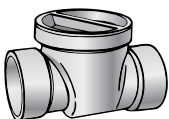

See list of products on pages 178-179.

DRIPLINE



- Reduces water use by 30% or more compared to overhead irrigation
- Complies with new water conservation legislation
- Highly efficient solution for landscape plantings & turfgrass
- Chemical-free root intrusion protection
- Longest run lengths in the industry
- Comprehensive offering from NDS Pressure Compensating, Non Pressure Compensating, Check Valve, Multiple Tubing size and color options

Dura Flo™ CV – One Dripline Tubing for All Applications

The new Dura Flo CV Check Valve Dripline combines the best of Dura Flo PC with a check valve. The combination brings the next level of water conservation to your irrigation project. The dripper features a check valve in combination with anti-siphon capabilities. The check valve prevents low emitter drainage on shut down and the anti-siphon feature eliminates back-siphonage at each emitter. This combination maximizes water efficiency by minimizing water loss and protecting each emitter from clogging and root intrusion. NDS Dura Flo CV is the only product offering this level of efficiency and protection in an all-in-one solution for drip line applications.

Features

PROFESSIONAL IRRIGATION



Check Valve

- Each emitter opens a 7.5 PSI – Longer run lengths lead to reduced material and labor costs
- Each emitter has a 2 PSI check valve that holds back up to 4.5 ft. of elevation – Prevents low head drainage & keeps the line full of water between irrigation intervals to provide instant watering when the system turns on for each cycle
- Reduces water waste – saves up to 1.39 gallons of water per 100 ft. of tubing



Anti-Siphon

- Each dripper is designed with an anti-siphon feature that prevents the suction of debris into the emitter
- Built-in anti-siphon feature eliminates the need for an air/vacuum relief valve

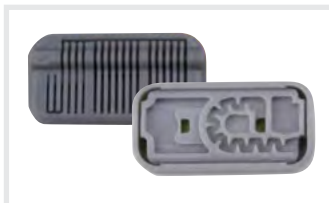

Emitter Specifications

- With its unique built-in filtration slits and self-cleaning design, clogging is minimized
- Flat, economical, check valve, pressure compensating, anti-siphon emitter maintains uniform flow rates at a wide range of working pressures and various topographies
- Operating range: 7.5 - 60 PSI • Flow rates: 0.4 gph, 0.6 gph, and 0.9 gph • Dripper spacing: 12", 18" or 24"



Pressure Compensation

- Conserves up to 70% of the water used by a conventional sprinkler irrigation system
- Distributes water evenly regardless of pressure fluctuations
- Self-flushing emitter eliminates debris from clogging the system during operation

Made in USA

DRIPLINE

17MM Dura Flo™ CV

Shrink Wrapped Packaging

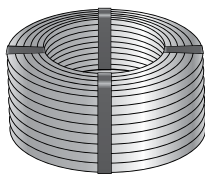

0.660" OD
Inline Check Valve

| Part No. | Description | Color | Coil Size/Type | Wt. per 100' (lbs.) | Product Class |
|-------------------|--|-------|--------------------|---------------------|---------------|
| SFCV-BR-6212-01S | 0.6 gph, 17mm Dura Flo™ Inline Check Valve Dripline (0.560" ID x 0.660" OD), 12" spacing | Brown | 100'/ Wrapped Coil | 3.3 | 21DF |
| SFCV-BR-6212-025S | 0.6 gph, 17mm Dura Flo™ Inline Check Valve Dripline (0.560" ID x 0.660" OD), 12" spacing | Brown | 250'/ Wrapped Coil | 3.3 | 21DF |
| SFCV-BR-6212-05S | 0.6 gph, 17mm Dura Flo™ Inline Check Valve Dripline (0.560" ID x 0.660" OD), 12" spacing | Brown | 500'/ Wrapped Coil | 3.3 | 21DF |
| SFCV-BR-6412-01S | 0.9 gph, 17mm Dura Flo™ Inline Check Valve Dripline (0.560" ID x 0.660" OD), 12" spacing | Brown | 100'/ Wrapped Coil | 3.3 | 21DF |
| SFCV-BR-6412-025S | 0.9 gph, 17mm Dura Flo™ Inline Check Valve Dripline (0.560" ID x 0.660" OD), 12" spacing | Brown | 250'/ Wrapped Coil | 3.3 | 21DF |
| SFCV-BR-6412-05S | 0.9 gph, 17mm Dura Flo™ Inline Check Valve Dripline (0.560" ID x 0.660" OD), 12" spacing | Brown | 500'/ Wrapped Coil | 3.3 | 21DF |
| SFCV-BR-6418-01S | 0.9 gph, 17mm Dura Flo™ Inline Check Valve Dripline (0.560" ID x 0.660" OD), 18" spacing | Brown | 100'/ Wrapped Coil | 3.3 | 21DF |
| SFCV-BR-6418-025S | 0.9 gph, 17mm Dura Flo™ Inline Check Valve Dripline (0.560" ID x 0.660" OD), 18" spacing | Brown | 250'/ Wrapped Coil | 3.3 | 21DF |
| SFCV-BR-6418-05S | 0.9 gph, 17mm Dura Flo™ Inline Check Valve Dripline (0.560" ID x 0.660" OD), 18" spacing | Brown | 500'/ Wrapped Coil | 3.3 | 21DF |
| SFCV-BR-6424-05S | 0.9 gph, 17mm Dura Flo™ Inline Check Valve Dripline (0.560" ID x 0.660" OD), 24" spacing | Brown | 500'/ Wrapped Coil | 3.3 | 21DF |

Notes: 1,000' Coils are Available Made to Order.

Brown 17mm Tubing with no emitters can be found on page 136 – See A660BR SKUs.

DRIPLINE

17MM Dura Flo™ PC

Shrink Wrapped
Packaging



PROFESSIONAL IRRIGATION



0.660" OD
Pressure Compensative

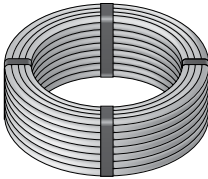

0.660" OD
Pressure Compensative

| Part No. | Description | Color | Coil Size/Type | Wt. per 100' (lbs.) | Product Class |
|--------------------|---|----------------------------|-------------------------|---------------------|---------------|
| SFPC-BR-17212-01S | 1/2 gph, 17mm Dura Flo™ Pressure Compensating Dripline (0.560" ID x 0.660" OD), 12" spacing | Brown | 100'/ Wrapped Coil | 4.1 | 21DF |
| SFPC-BR-17212-025S | 1/2 gph, 17mm Dura Flo™ Pressure Compensating Dripline (0.560" ID x 0.660" OD), 12" spacing | Brown | 250'/ Wrapped Coil | 4.1 | 21DF |
| SFPC-BR-17212-05S | 1/2 gph, 17mm Dura Flo™ Pressure Compensating Dripline (0.560" ID x 0.660" OD), 12" spacing | Brown | 500'/ Wrapped Coil | 4.1 | 21DF |
| SFPC-BR-17218-01S | 1/2 gph, 17mm Dura Flo™ Pressure Compensating Dripline (0.560" ID x 0.660" OD), 18" spacing | Brown | 100'/ Wrapped Coil | 3.9 | 21DF |
| SFPC-BR-17218-025S | 1/2 gph, 17mm Dura Flo™ Pressure Compensating Dripline (0.560" ID x 0.660" OD), 18" spacing | Brown | 250'/ Wrapped Coil | 3.9 | 21DF |
| SFPC-BR-17218-05S | 1/2 gph, 17mm Dura Flo™ Pressure Compensating Dripline (0.560" ID x 0.660" OD), 18" spacing | Brown | 500'/ Wrapped Coil | 3.9 | 21DF |
| SFPC-BR-17412-025S | 1 gph, 17mm Dura Flo™ Pressure Compensating Dripline (0.560" ID x 0.660" OD), 12" spacing | Brown | 250'/ Wrapped Coil | 4.1 | 21DF |
| SFPC-BR-17412-05S | 1 gph, 17mm Dura Flo™ Pressure Compensating Dripline (0.560" ID x 0.660" OD), 12" spacing | Brown | 500'/ Wrapped Coil | 4.1 | 21DF |
| SFPC-PS-17412-05S | 1 gph, 17mm Dura Flo™ Pressure Compensating Dripline (0.560" ID x 0.660" OD), 12" spacing | Brown/ Purple Stripe | 500'/ Wrapped Coil | 4.1 | 21DF |
| SFPC-RC-17412-05S | 1 gph, 17mm Dura Flo™ Pressure Compensating Dripline (0.560" ID x 0.660" OD), 12" spacing | Purple | 500'/ Wrapped Coil | 4.1 | 21DF |
| SFPC-BR-17412-10 | 1 gph, 17mm Dura Flo™ Pressure Compensating Dripline (0.560" ID x 0.660" OD), 12" spacing | Brown | 1,000'/ Wrapped Coil | 3.8 | 21DF |

Note: 1,000' Coils are Available Made to Order.

DRIPLINE

16MM Dura Flo™ PC



0.640" OD
Pressure Compensative

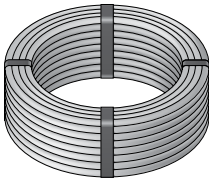

0.640" OD
Pressure Compensative

| Part No. | Description | Color | Coil Size/Type | Wt. per 100' (lbs.) | Product Class |
|------------------|---|-------|----------------|---------------------|---------------|
| SFPC-BR-6212-025 | 1/2 gph, 16mm Dura Flo™ Pressure Compensating Dripline (0.550" ID x 0.640" OD), 12" spacing | Brown | 250'/Coil | 4.0 | 21DF |
| SFPC-BR-6212-05 | 1/2 gph, 16mm Dura Flo™ Pressure Compensating Dripline (0.550" ID x 0.640" OD), 12" spacing | Brown | 500'/Coil | 4.0 | 21DF |
| SFPC-BL-6412-01 | 1 gph, 16mm Dura Flo™ Pressure Compensating Dripline (0.550" ID x 0.640" OD), 12" spacing | Black | 100'/Coil | 4.0 | 21DF |
| SFPC-BR-6412-01 | 1 gph, 16mm Dura Flo™ Pressure Compensating Dripline (0.550" ID x 0.640" OD), 12" spacing | Brown | 100'/Coil | 4.0 | 21DF |
| SFPC-BR-6412-025 | 1 gph, 16mm Dura Flo™ Pressure Compensating Dripline (0.550" ID x 0.640" OD), 12" spacing | Brown | 250'/Coil | 4.0 | 21DF |
| SFPC-BR-6412-05 | 1 gph, 16mm Dura Flo™ Pressure Compensating Dripline (0.550" ID x 0.640" OD), 12" spacing | Brown | 500'/Coil | 4.0 | 21DF |
| SFPC-BR-6418-01 | 1 gph, 16mm Dura Flo™ Pressure Compensating Dripline (0.550" ID x 0.640" OD), 18" spacing | Brown | 100'/Coil | 3.8 | 21DF |
| SFPC-BR-6418-025 | 1 gph, 16mm Dura Flo™ Pressure Compensating Dripline (0.550" ID x 0.640" OD), 18" spacing | Brown | 250'/Coil | 3.8 | 21DF |
| SFPC-BL-6418-05 | 1 gph, 16mm Dura Flo™ Pressure Compensating Dripline (0.550" ID x 0.640" OD), 18" spacing | Black | 500'/Coil | 3.8 | 21DF |
| SFPC-BR-6418-05 | 1 gph, 16mm Dura Flo™ Pressure Compensating Dripline (0.550" ID x 0.640" OD), 18" spacing | Brown | 500'/Coil | 3.8 | 21DF |

PROFESSIONAL IRRIGATION

DRIPLINE

18MM Dura Flo™ PC



0.700" OD
Pressure Compensative

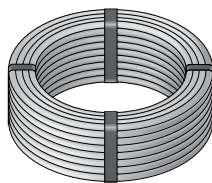

0.700" OD
Pressure Compensative

| Part No. | Description | Color | Coil Size/Type | Wt. per 100' (lbs.) | Product Class |
|-----------------|---|-------|----------------|---------------------|---------------|
| SFPC-BL-7212-01 | 1/2 gph, 18mm Dura Flo™ Pressure Compensating Dripline (0.600" ID x 0.700" OD), 12" spacing | Black | 100'/Coil | 4.7 | 21DF |
| SFPC-BR-7212-01 | 1/2 gph, 18mm Dura Flo™ Pressure Compensating Dripline (0.600" ID x 0.700" OD), 12" spacing | Brown | 100'/Coil | 4.7 | 21DF |
| SFPC-BL-7212-05 | 1/2 gph, 18mm Dura Flo™ Pressure Compensating Dripline (0.600" ID x 0.700" OD), 12" spacing | Black | 500'/Coil | 4.7 | 21DF |
| SFPC-BR-7218-05 | 1/2 gph, 18mm Dura Flo™ Pressure Compensating Dripline (0.600" ID x 0.700" OD), 18" spacing | Brown | 500'/Coil | 4.5 | 21DF |
| SFPC-BL-7412-01 | 1 gph, 18mm Dura Flo™ Pressure Compensating Dripline (0.600" ID x 0.700" OD), 12" spacing | Black | 100'/Coil | 4.7 | 21DF |
| SFPC-BR-7412-01 | 1 gph, 18mm Dura Flo™ Pressure Compensating Dripline (0.600" ID x 0.700" OD), 12" spacing | Brown | 100'/Coil | 4.7 | 21DF |
| SFPC-BL-7412-05 | 1 gph, 18mm Dura Flo™ Pressure Compensating Dripline (0.600" ID x 0.700" OD), 12" spacing | Black | 500'/Coil | 4.7 | 21DF |
| SFPC-BR-7412-05 | 1 gph, 18mm Dura Flo™ Pressure Compensating Dripline (0.600" ID x 0.700" OD), 12" spacing | Brown | 500'/Coil | 4.7 | 21DF |
| SFPC-BL-7418-05 | 1 gph, 18mm Dura Flo™ Pressure Compensating Dripline (0.600" ID x 0.700" OD), 18" spacing | Black | 500'/Coil | 4.5 | 21DF |
| SFPC-BR-7418-05 | 1 gph, 18mm Dura Flo™ Pressure Compensating Dripline (0.600" ID x 0.700" OD), 18" spacing | Brown | 500'/Coil | 4.5 | 21DF |

18MM Dura Flo™ CV

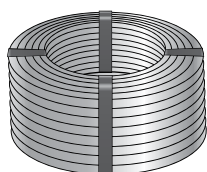

0.700" OD
Inline Check Valve

| Part No. | Description | Color | Coil Size/Type | Wt. per 100' (lbs.) | Product Class |
|------------------|--|-------|----------------|---------------------|---------------|
| SFCV-BR-7212-01 | 0.6 gph, 18mm Dura Flo™ Inline Check Valve Dripline (0.600" ID x 0.700" OD), 12" spacing | Brown | 100'/Coil | 3.3 | 21DF |
| SFCV-BR-7412-01 | 0.9 gph, 18mm Dura Flo™ Inline Check Valve Dripline (0.600" ID x 0.700" OD), 12" spacing | Brown | 100'/Coil | 3.3 | 21DF |
| SFCV-BR-7412-025 | 0.9 gph, 18mm Dura Flo™ Inline Check Valve Dripline (0.600" ID x 0.700" OD), 12" spacing | Brown | 250'/Coil | 3.3 | 21DF |
| SFCV-BR-7412-10 | 0.9 gph, 18mm Dura Flo™ Inline Check Valve Dripline (0.600" ID x 0.700" OD), 12" spacing | Brown | 1,000'/Coil | 3.3 | 21DF |
| SFCV-BR-7218-01 | 0.9 gph, 18mm Dura Flo™ Inline Check Valve Dripline (0.600" ID x 0.700" OD), 18" spacing | Brown | 100'/Coil | 3.3 | 21DF |
| SFCV-BR-7218-025 | 0.9 gph, 18mm Dura Flo™ Inline Check Valve Dripline (0.600" ID x 0.700" OD), 18" spacing | Brown | 250'/Coil | 3.3 | 21DF |

DRIPLINE – TECHNICAL INFORMATION

17MM Dura Flo™ CV Maximum Recommended Length of Run (Feet)

| Initial Pressure | 12" SPACING | | | 18" SPACING | | | 24" SPACING | | |
|------------------|-------------|---------|---------|-------------|---------|---------|-------------|---------|---------|
| | 0.4 GPH | 0.6 GPH | 0.9 GPH | 0.4 GPH | 0.6 GPH | 0.9 GPH | 0.4 GPH | 0.6 GPH | 0.9 GPH |
| 15 PSI | 261' | 221' | 161' | 347' | 292' | 214' | 420' | 354' | 260' |
| 20 PSI | 357' | 300' | 221' | 477' | 399' | 294' | 576' | 488' | 358' |
| 25 PSI | 422' | 354' | 259' | 563' | 471' | 346' | 684' | 575' | 421' |
| 30 PSI | 471' | 395' | 289' | 629' | 526' | 385' | 765' | 642' | 471' |
| 35 PSI | 514' | 429' | 314' | 687' | 571' | 418' | 835' | 699' | 512' |
| 40 PSI | 550' | 460' | 336' | 735' | 618' | 449' | 893' | 748' | 549' |
| 45 PSI | 582' | 486' | 355' | 779' | 650' | 473' | 947' | 791' | 581' |
| 50 PSI | 610' | 508' | 372' | 818' | 677' | 493' | 995' | 830' | 610' |

Discharge Rates (GPH)

| Model | Part No. | 10 PSI | 15 PSI | 20 PSI | 25 PSI | 30 PSI | 40 PSI | 60 PSI | 80 PSI |
|-------------------------------|------------------|----------|----------|----------|----------|----------|----------|----------|---------|
| Dura Flo™ JR Mini Dripperline | DS 20 | | | 1.7 gph | 1.9 gph | 2.0 gph | 2.2 gph | 2.5 gph | 2.1 gph |
| | DS 30 | | | 3.0 gph | 3.3 gph | 3.6 gph | 3.6 gph | 3.6 gph | 3.0 gph |
| Dura Flo™ PC Dripperline | SFJR-XX-XX-XX | 0.39 gph | 0.47 gph | 0.56 gph | 0.63 gph | 0.69 gph | | | |
| | SFPC-XX-62XX-XX | 0.45 gph | 0.50 gph | 0.50 gph | 0.50 gph | 0.50 gph | 0.50 gph | 0.45 gph | |
| | SFPC-XX-64XX-XX | 0.75 gph | 0.90 gph | 0.90 gph | 0.90 gph | 0.90 gph | 0.85 gph | 0.80 gph | |
| | SFPC-XX-68XX-XX | 1.40 gph | 1.60 gph | 1.65 gph | 1.65 gph | 1.65 gph | 1.65 gph | 1.65 gph | |
| | SFPC-XX-72XX-XX | 0.50 gph | 0.55 gph | 0.55 gph | 0.55 gph | 0.55 gph | 0.55 gph | 0.50 gph | |
| | SFPC-XX-74XX-XX | 0.80 gph | 0.95 gph | 0.95 gph | 0.95 gph | 0.95 gph | 0.95 gph | 0.85 gph | |
| | SFPC-XX-78XX-XX | 1.50 gph | 1.75 gph | 1.80 gph | 1.80 gph | 1.80 gph | 1.80 gph | 1.80 gph | |
| Dura Flo™ Dripperline | SFPC-XX-202XX-XX | 0.43 gph | 0.45 gph | 0.48 gph | 0.48 gph | 0.49 gph | 0.49 gph | 0.45 gph | |
| | SFPC-XX-204XX-XX | 0.80 gph | 0.83 gph | 0.83 gph | 0.86 gph | 0.88 gph | 0.93 gph | 0.94 gph | |
| | SFPC-XX-208XX-XX | 1.55 gph | 1.62 gph | 1.62 gph | 1.65 gph | 1.65 gph | 1.62 gph | 1.77 gph | |
| | SF-XX-62XX-XX | 0.36 gph | 0.40 gph | 0.51 gph | 0.60 gph | 0.68 gph | 0.78 gph | | |
| | SF-XX-64XX-XX | 0.63 gph | 0.78 gph | 0.92 gph | 1.08 gph | 1.21 gph | 1.41 gph | | |
| Mini Flo™ Emitter | SF-XX-68XX-XX | 1.26 gph | 1.58 gph | 1.79 gph | 2.00 gph | 2.20 gph | 2.54 gph | | |
| | SF-XX-72XX-XX | 0.40 gph | 0.48 gph | 0.56 gph | 0.66 gph | 0.75 gph | 0.86 gph | | |
| | SF-XX-74XX-XX | 0.71 gph | 0.86 gph | 1.01 gph | 1.19 gph | 1.35 gph | 1.56 gph | | |
| Laser Drilled Soaker Hose | SF-XX-78XX-XX | 1.40 gph | 1.75 gph | 1.98 gph | 2.22 gph | 2.44 gph | 2.82 gph | | |
| | MIL 5 | 0.51 gph | 0.63 gph | 0.73 gph | 0.81 gph | | | | |
| | MIL 10 | 0.86 gph | 1.06 gph | 1.22 gph | 1.36 gph | | | | |
| | ALT 6/12 | 1.0 gph | 1.30 gph | 1.6 gph | | | | | |

Maximum Recommended Length of Run (Feet)

| Model | Nominal Flow Rate | Initial Pressure | I.D. of Tubing (inches) | | | | | | | | | |
|------------------|-------------------|------------------|-----------------------------------|-------|-------|-------|-------|--------|--------|--------|--------|--------|
| | | | .520" | .600" | .520" | .600" | .520" | .600" | .520" | .600" | .520" | .600" |
| | | | Spacing Between Emitters (inches) | | | | | | | | | |
| | | | 18" | | 24" | | 36" | | 48" | | 60" | |
| PC Plus™ Emitter | 0.5 gph | 20 PSI | 350' | 440' | 415' | 535' | 530' | 68' | 640' | 820' | 740' | 970' |
| | | 30 PSI | 460' | 590' | 550' | 710' | 700' | 900' | 850' | 1,090' | 1,000' | 1,290' |
| | | 40 PSI | 540' | 695' | 640' | 825' | 840' | 1,080' | 1,020' | 1,310' | 1,160' | 1,500' |
| | 1.0 gph | 20 PSI | 220' | 280' | 265' | 340' | 340' | 440' | 410' | 530' | 480' | 620' |
| | | 30 PSI | 290' | 375' | 350' | 450' | 450' | 580' | 540' | 690' | 630' | 820' |
| | | 40 PSI | 340' | 440' | 410' | 530' | 540' | 690' | 650' | 840' | 750' | 965' |
| | 2.0 gph | 20 PSI | 160' | 200' | 190' | 240' | 240' | 305' | 300' | 370' | 350' | 435' |
| | | 30 PSI | 210' | 265' | 255' | 320' | 325' | 405' | 390' | 490' | 460' | 575' |
| | | 40 PSI | 250' | 310' | 300' | 370' | 380' | 475' | 460' | 575' | 540' | 675' |

PROFESSIONAL IRRIGATION

DRIPLINE – TECHNICAL INFORMATION

Maximum Recommended Length of Run (Feet)

| Model | Nominal Flow Rate | Initial Pressure | Spacing Between Emitters (inches) | | | | | | | | | | | | | | | | | |
|-----------------------------|-------------------|------------------|-----------------------------------|----------|----------|----------|----------|----------|----------|----------|----------|----------|----------|----------|----------|----------|----------|----------|----------|----------|
| | | | 12" | | | 18" | | | 24" | | | 36" | | | 48" | | | 60" | | |
| | | | Tubing Size | | | | | | | | | | | | | | | | | |
| | | | .630" OD | .710" OD | .830" OD | .630" OD | .710" OD | .830" OD | .630" OD | .710" OD | .830" OD | .630" OD | .710" OD | .830" OD | .630" OD | .710" OD | .830" OD | .630" OD | .710" OD | .830" OD |
| Dura Flo™ Emitter-line | 0.5 gph | 20 PSI | 180' | 240' | N/A | 250' | 340' | N/A | 300' | 420' | N/A | 400' | 550' | N/A | 490' | 680' | N/A | 570' | 790' | N/A |
| | 1.0 gph | 20 PSI | 130' | 180' | N/A | 170' | 240' | N/A | 210' | 300' | N/A | 270' | 390' | N/A | 340' | 480' | N/A | 390' | 550' | N/A |
| | 2.0 gph | 20 PSI | 95' | 120' | N/A | 125' | 150' | N/A | 150' | 190' | N/A | 200' | 250' | N/A | 250' | 310' | N/A | 285' | 360' | N/A |
| Dura Flow PCT™ Emitter-line | 0.5 gph | | .640" OD | .700" OD | .830" OD | .640" OD | .700" OD | .830" OD | .640" OD | .700" OD | .830" OD | .640" OD | .700" OD | .830" OD | .640" OD | .700" OD | .830" OD | .640" OD | .700" OD | .830" OD |
| | | 15 PSI | 180' | 210' | 315' | 255' | 300' | 495' | 325' | 380' | 560' | 455' | 525' | 780' | 560' | 650' | 950' | 655' | 760' | 1,090' |
| | | 25 PSI | 265' | 315' | 460' | 380' | 450' | 660' | 485' | 570' | 825' | 675' | 780' | 1,160' | 850' | 975' | 1,420' | 990' | 1,140' | 1,630' |
| | | 35 PSI | 325' | 380' | 565' | 460' | 540' | 790' | 580' | 685' | 990' | 810' | 940' | 1,400' | 1,020' | 1,175' | 1,700' | 1,190' | 1,375' | 1,950' |
| | 45 PSI | 365' | 430' | 625' | 520' | 610' | 890' | 660' | 775' | 1,120' | 920' | 1,065' | 1,580' | 1,150' | 1,330' | 1,930' | 1,345' | 1,555' | 2,200' | |
| | 1.0 gph | 15 PSI | 130' | 155' | 215' | 185' | 220' | 315' | 240' | 280' | 380' | 330' | 380' | 540' | 410' | 475' | 660' | 480' | 555' | 755' |
| | | 25 PSI | 195' | 230' | 330' | 280' | 330' | 460' | 355' | 420' | 575' | 485' | 570' | 840' | 615' | 715' | 970' | 720' | 835' | 1,080' |
| | | 35 PSI | 240' | 280' | 395' | 335' | 395' | 560' | 430' | 505' | 690' | 585' | 690' | 970' | 740' | 860' | 1,190' | 865' | 1,005' | 1,360' |
| | | 45 PSI | 265' | 315' | 445' | 380' | 450' | 625' | 485' | 570' | 775' | 660' | 780' | 1,100' | 835' | 975' | 1,335' | 975' | 1,140' | 1,530' |
| | 2.0 gph | 15 PSI | 85' | 100' | 150' | 125' | 145' | 200' | 155' | 180' | 250' | 215' | 245' | 350' | 260' | 305' | 430' | 300' | 355' | 495' |
| | | 25 PSI | 125' | 150' | 215' | 180' | 215' | 300' | 230' | 270' | 380' | 315' | 365' | 520' | 400' | 455' | 640' | 470' | 530' | 730' |
| | | 35 PSI | 150' | 180' | 265' | 215' | 255' | 330' | 270' | 320' | 460' | 380' | 440' | 635' | 480' | 550' | 775' | 560' | 645' | 890' |
| 45 PSI | | 170' | 200' | 295' | 250' | 290' | 410' | 305' | 360' | 510' | 430' | 500' | 715' | 540' | 625' | 875' | 630' | 730' | 1,000' | |

PROFESSIONAL IRRIGATION

| Model | Nominal Flow Rate | Initial Pressure | Spacing Between Emitters (inches) | | | | |
|-------------------|-------------------|------------------|-----------------------------------|-----|-----|-----|-----|
| | | | 12" | 18" | 24" | 30" | 36" |
| Mini Flo™ Emitter | 0.5 gph | 20 PSI | 20' | 25' | 30' | 35' | 40' |
| | 1.0 gph | 20 PSI | 12' | 15' | 18' | 21' | 24' |

| Model | Nominal Flow Rate | Spacing | Maximum Run | Model | Nominal Flow Rate | Spacing | Maximum Run |
|-------------------------------|-------------------|---------|-------------|----------------------------------|-------------------|---------|-------------|
| Dura Flo™ JR Mini Dripperline | 0.5 gph | 6" | 19 ft. | Laser Drilled Soaker Hose (1/4") | 1.0 gph | 6" | 12 ft. |
| | 0.5 gph | 12" | 33 ft. | | 1.0 gph | 12" | 20 ft. |

Calculations are based on: 1. No elevation changes over length of run. 2. Maximum allowable variation in discharge rate of ±7.5%.

Refer to Technical Specifications Document for Flowcharts and Run Length Information at ndspro.com/specifications

DRIPLINE – TECHNICAL INFORMATION

The Following Formula Should be Used to Calculate Application Rates

$$\text{Application Rate (inches per hour)} = \frac{231 \times \text{Emitter Flow Rates (gph)}}{\text{Spacing between Poly Laterals (inches)} \times \text{Spacing between Emission Device (inches)}}$$

(A)
(B)

Example

Emitter Flow Rate = 1 gph

Spacing between Emission Device = 18"

Spacing between Poly Laterals = 16"

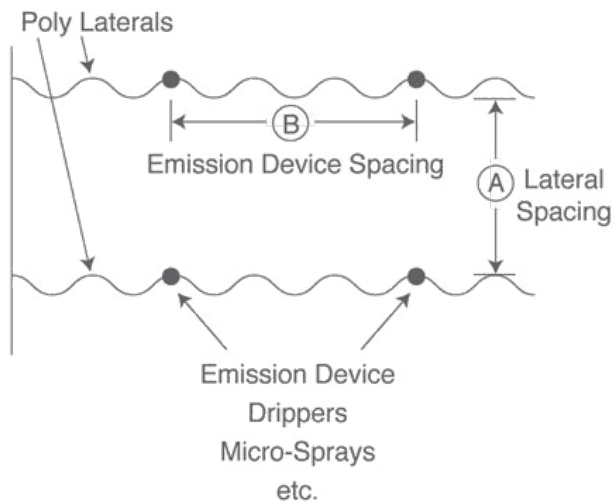

Question

What is the application rate?

Solution

$$\text{Application Rate} = \frac{231 \times 1}{16 \times 18} = 0.80\text{"/hr}$$

Drip Application Rates (Inches/Hour) – Based on Nominal Flow Rates

| Emitter Spacing | 1/2 gph | | | | | | | | | | |
|-----------------|-------------------------------|-----|-----|-----|-----|-----|-----|-----|-----|-----|-----|
| | Spacing between Poly Laterals | | | | | | | | | | |
| | 12" | 13" | 14" | 15" | 16" | 17" | 18" | 19" | 20" | 22" | 24" |
| 12" | .80 | .74 | .69 | .64 | .60 | .57 | .53 | .51 | .48 | .44 | .40 |
| 18" | .53 | .49 | .46 | .43 | .40 | .38 | .36 | .34 | .32 | .29 | .27 |
| 24" | .40 | .37 | .34 | .32 | .30 | .28 | .26 | .25 | .24 | .22 | .20 |

| Emitter Spacing | 1 gph | | | | | | | | | | |
|-----------------|-------------------------------|------|------|------|------|------|------|------|-----|-----|-----|
| | Spacing between Poly Laterals | | | | | | | | | | |
| | 12" | 13" | 14" | 15" | 16" | 17" | 18" | 19" | 20" | 22" | 24" |
| 12" | 1.60 | 1.48 | 1.38 | 1.28 | 1.20 | 1.14 | 1.06 | 1.02 | .96 | .88 | .80 |
| 18" | 1.07 | .99 | .92 | .86 | .80 | .75 | .71 | .68 | .64 | .58 | .53 |
| 24" | .80 | .74 | .69 | .64 | .60 | .57 | .53 | .51 | .48 | .44 | .40 |

| Emitter Spacing | 2 gph | | | | | | | | | | |
|-----------------|-------------------------------|------|------|------|------|------|------|------|------|------|------|
| | Spacing between Poly Laterals | | | | | | | | | | |
| | 12" | 13" | 14" | 15" | 16" | 17" | 18" | 19" | 20" | 22" | 24" |
| 12" | 3.20 | 2.96 | 2.75 | 2.56 | 2.40 | 2.28 | 2.12 | 2.04 | 1.92 | 1.76 | 1.60 |
| 18" | 2.14 | 1.98 | 1.84 | 1.72 | 1.60 | 1.50 | 1.42 | 1.36 | 1.28 | 1.16 | 1.06 |
| 24" | 1.60 | 1.48 | 1.38 | 1.28 | 1.20 | 1.14 | 1.06 | 1.02 | .96 | .88 | .80 |

SINGLE-OUTLET DEVICES

Pressure Compensating

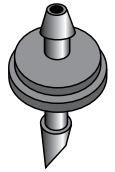

ACCUFLOW™

| Part No. | Description | Color | Bag Qty./ Box Qty. | Wt. per 100 (lbs.) | Product Class |
|------------------|---|-------|-----------------------|-----------------------|------------------|
| AccuFlow™ | | | | | |
| AFPC 5 | 1/2 gph Pressure Compensating AccuFlow™ Emitter | Blue | 100/N/A | N/A | 21DI |
| AFPC 5/25 | 1/2 gph Pressure Compensating AccuFlow™ Emitter | Blue | 25/N/A | N/A | 21DI |
| AFPC 5/1000 | 1/2 gph Pressure Compensating AccuFlow™ Emitter | Blue | 1,000/N/A | N/A | 21DI |
| AFPC 10 | 1 gph Pressure Compensating AccuFlow™ Emitter | Black | 100/N/A | N/A | 21DI |
| AFPC 10/25 | 1 gph Pressure Compensating AccuFlow™ Emitter | Black | 25/N/A | N/A | 21DI |
| AFPC 20 | 2 gph Pressure Compensating AccuFlow™ Emitter | Red | 100/N/A | N/A | 21DI |
| AFPC 20/25 | 2 gph Pressure Compensating AccuFlow™ Emitter | Red | 25/N/A | N/A | 21DI |
| AFPC 50 | 5 gph Pressure Compensating AccuFlow™ Emitter | Tan | 100/N/A | N/A | 21DI |
| AFPC 50/25 | 5 gph Pressure Compensating AccuFlow™ Emitter | Tan | 25/N/A | N/A | 21DI |
| AFPC 50/1000 | 5 gph Pressure Compensating AccuFlow™ Emitter | Tan | 1,000/N/A | N/A | 21DI |

Non-Pressure Compensating

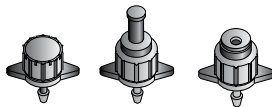

360
180

BUB

FAN

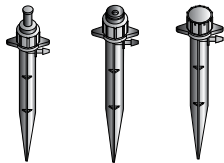

BUB

FAN

360
180

DIAL-A-FLO™

| Part No. | Description | Color | Bag Qty./ Box Qty. | Wt. per 100 (lbs.) | Product Class |
|--------------------|---|-------|-----------------------|-----------------------|------------------|
| Dial-a-Flo™ | | | | | |
| DAFB 360 | 360°, 8 Stream, 0-10 gph, 1/4" Barbed, Adjustable Dial-a-Flo™ Emitter | Black | 100/2,500 | 0.5 | 21DI |
| DAFB 180 | 180°, 5 Stream, 0-10 gph, 1/4" Barbed, Adjustable Dial-a-Flo™ Emitter | Black | 100/2,500 | 0.5 | 21DI |
| DAFB FAN | 360°, Fan Spray, 0-20 gph, 1/4" Barbed, Adjustable Dial-a-Flo™ Emitter | Black | 100/2,500 | 0.6 | 21DI |
| DAFB BUB | Umbrella Bubbler, 0-25 gph, 1/4" Barbed, Adjustable Dial-a-Flo™ Emitter | Black | 100/2,500 | 0.7 | 21DI |
| DAFT 360 | 360°, 8 Stream, 0-10 gph, 10/32 NDS Threads, Adjustable Dial-a-Flo™ Emitter | Black | 100/2,500 | 0.6 | 21DI |
| DAFT 180 | 180°, 5 Stream, 0-10 gph, 10/32 NDS Threads, Adjustable Dial-a-Flo™ Emitter | Black | 100/2,500 | 0.6 | 21DI |
| DAFT FAN | 360°, Fan Spray, 0-20 gph, 10/32 NDS Threads, Adjustable Dial-a-Flo™ Emitter | Black | 100/2,500 | 0.7 | 21DI |
| DAFT BUB | Umbrella Bubbler, 0-25 gph, 10/32 NDS Threads, Adjustable Dial-a-Flo™ Emitter | Black | 100/2,500 | 0.8 | 21DI |
| DAFS 360 | 360°, 8 Stream, 0-10 gph, Adjustable Dial-a-Flo™ Emitter with 6" Stake | Black | 100/1,000 | 1.4 | 21DI |
| DAFS 180 | 180°, 5 Stream, 0-10 gph, Adjustable Dial-a-Flo™ Emitter with 6" Stake | Black | 100/1,000 | 1.4 | 21DI |
| DAFS 135 | 135°, 4 Stream, 0-10 gph, Adjustable Dial-a-Flo™ Emitter with 6" Stake | Black | 100/1,000 | 1.4 | 21DI |
| DAFS BUB | Umbrella Bubbler, 0-25 gph, Adjustable Dial-a-Flo™ Emitter with 6" Stake | Black | 100/1,000 | 1.5 | 21DI |

SINGLE-OUTLET DEVICES

Non-Pressure Compensating (continued)

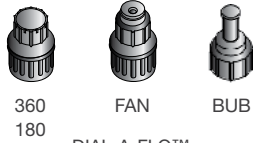

DIAL-A-FLO™



SUPER-FLO™

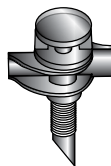
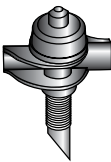
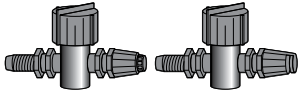

HYDRO-FLO™

| Part No. | Description | Color | Bag Qty./ Box Qty. | Wt. per 100 (lbs.) | Product Class |
|------------------------------|---|--------|-----------------------|-----------------------|------------------|
| Dial-a-Flo™ (cont.) | | | | | |
| DAFU 360 | 360°, 8 Stream, 0-10 gph, 1/2" FIPT, Adjustable Dial-a-Flo™ Emitter | Black | 50/500 | 1.8 | 21DI |
| DAFU 180 | 180°, 5 Stream, 0-10 gph, 1/2" FIPT, Adjustable Dial-a-Flo™ Emitter | Black | 50/500 | 1.7 | 21DI |
| DAFU FAN | 360°, Fan Spray, 0-20 gph, 1/2" FIPT, Adjustable Dial-a-Flo™ Emitter | Black | 50/500 | 1.8 | 21DI |
| DAFU BUB | Umbrella Bubbler, 0-25 gph, 1/2" FIPT, Adjustable Dial-a-Flo™ Emitter | Black | 50/500 | 1.9 | 21DI |
| Super-Flo™ | | | | | |
| TAE 10 | 1 gph, Laminar Flow, Take-Apart Super-Flo™ Emitter | Black | 100/2,000 | 0.4 | 21DI |
| TAE 20 | 2 gph, Laminar Flow, Take-Apart Super-Flo™ Emitter | Green | 100/2,000 | 0.4 | 21DI |
| TAE 40 | 4 gph, Laminar Flow, Take-Apart Super-Flo™ Emitter | Yellow | 100/2,000 | 0.4 | 21DI |
| Hydro-Flo™ | | | | | |
| VF | 0-25 gph, Hydro-Flo™ Adjustable Jet Body Only | Black | 100/500 | 0.4 | 21DI |
| VF 360 | 0-25 gph, Hydro-Flo™ Adjustable Jet (360° Pattern – Stream Spray, 10-32 NPT Inlet)* | Black | 100/500 | 0.5 | 21DI |
| VF 180 | 0-25 gph, Hydro-Flo™ Adjustable Jet (180° Pattern – Fan Spray, 10-32 NPT Inlet)* | Black | 100/500 | 0.5 | 21DI |
| VF 90 | 0-25 gph, Hydro-Flo™ Adjustable Jet (90° Pattern – Fan Spray, 10-32 NPT Inlet)* | Black | 100/500 | 0.5 | 21DI |
| *Uses SAJ Adapter (page 117) | | | | | |
| TFC 360 | Cap-360°, 12 Finger Spray Hydro-Flo™ Jet | Black | 100/2,500 | 0.1 | 21DI |
| TFC 180 | Cap-180°, Fan Spray Hydro-Flo™ Jet | Black | 100/2,500 | 0.1 | 21DI |
| TFC 90 | Cap-90°, Fan Spray Hydro-Flo™ Jet | Black | 100/2,500 | 0.1 | 21DI |
| TFC 33 | Cap-Strip Fan Spray Hydro-Flo™ Jet | Black | 100/2,500 | 0.1 | 21DI |
| TFB 30 | Base-0.030" Nozzle Hydro-Flo™ Jet | Black | 100/2,500 | 0.1 | 21DI |
| TFB 40 | Base-0.040" Nozzle Hydro-Flo™ Jet | Blue | 100/2,500 | 0.1 | 21DI |
| TFB 50 | Base-0.050" Nozzle Hydro-Flo™ Jet | Green | 100/2,500 | 0.1 | 21DI |
| TFB 60 | Base-0.060" Nozzle Hydro-Flo™ Jet | Red | 100/2,500 | 0.1 | 21DI |
| TFB 70 | Base-0.070" Nozzle Hydro-Flo™ Jet | White | 100/2,500 | 0.1 | 21DI |
| TF 436 | 0.040" Nozzle, 360° Fan Spray Single-Piece Hydro-Flo™ Jet | Blue | 100/2,500 | 0.1 | 21DI |
| TF 536 | 0.050" Nozzle, 360° Fan Spray Single-Piece Hydro-Flo™ Jet | Green | 100/2,500 | 0.1 | 21DI |
| TF 636 | 0.060" Nozzle, 360° Fan Spray Single-Piece Hydro-Flo™ Jet | Red | 100/2,500 | 0.1 | 21DI |
| TF 318 | 0.030" Nozzle, 180° Fan Spray Single-Piece Hydro-Flo™ Jet | Black | 100/2,500 | 0.1 | 21DI |
| TF 418 | 0.040" Nozzle, 180° Fan Spray Single-Piece Hydro-Flo™ Jet | Blue | 100/2,500 | 0.1 | 21DI |
| TF 518 | 0.050" Nozzle, 180° Fan Spray Single-Piece Hydro-Flo™ Jet | Green | 100/2,500 | 0.1 | 21DI |
| TF 618 | 0.060" Nozzle, 180° Fan Spray Single-Piece Hydro-Flo™ Jet | Red | 100/2,500 | 0.1 | 21DI |
| TF 39 | 0.030" Nozzle, 90° Fan Spray Single-Piece Hydro-Flo™ Jet | Black | 100/2,500 | 0.1 | 21DI |
| TF 49 | 0.040" Nozzle, 90° Fan Spray Single-Piece Hydro-Flo™ Jet | Blue | 100/2,500 | 0.1 | 21DI |
| TF 59 | 0.050" Nozzle, 90° Fan Spray Single-Piece Hydro-Flo™ Jet | Green | 100/2,500 | 0.1 | 21DI |
| TF 69 | 0.060" Nozzle, 90° Fan Spray Single-Piece Hydro-Flo™ Jet | Red | 100/2,500 | 0.1 | 21DI |

SINGLE-OUTLET DEVICES

RootWise™

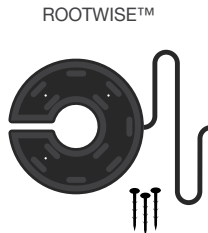

| Part No. | Description | Color | Bag Qty./ Box Qty. | Product Class |
|------------------|--------------------------------|-------|-----------------------|---------------|
| RootWise™ | | | | |
| RW16N | 16" Diameter 360° Watering Pad | Black | 1/8 | 21DI |
| RW16N6P | 16" Diameter 360° Watering Pad | Black | 6/N/A | 21DI |

Non-Pressure Compensating



MICRO-FLO™



TRI-FLO™

| Part No. | Description | Color | Bag Qty./ Box Qty. | Wt. per 100 (lbs.) | Product Class |
|--|---|-------|-----------------------|-----------------------|---------------|
| Micro-Flo™ | | | | | |
| MFA | 0-25 gph, Micro-Flo™ Adjustable Micro-Sprinkler with Shutoff (10-32 NPT Inlet)* | Red | 50/300 | 1.2 | 21DI |
| *Uses SAJ Adapter (page 117) | | | | | |
| Tri-Flo™ | | | | | |
| TFS 9 | 3 Flow Tri-Flo™ Spraystick, 90° Pattern | Blue | 100/2,000 | 0.6 | 21DI |
| TFS 16 | 3 Flow Tri-Flo™ Spraystick, 160° Pattern | Green | 100/2,000 | 0.7 | 21DI |
| Use with 1/8" tubing A 185 (page 135). Not recommended for vinyl tubing. | | | | | |

Risers & Accessories

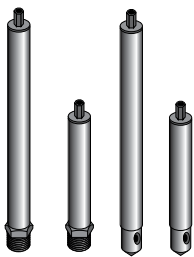

HYDRO-POP™

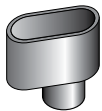

| Part No. | Description | Color | Bag Qty./ Box Qty. | Wt. per 100 (lbs.) | Product Class |
|-------------------|--|-------|-----------------------|-----------------------|---------------|
| Hydro-Pop™ | | | | | |
| HYP 250 | Hydro-Pop™ Pop-up Riser with 1/4" Compression Fit Inlet Maximum 9" Extension (Minimum Pressure Required = 15 PSI) | Black | 25/100 | 12.9 | 21DI |
| HYP 500 | Hydro-Pop™ Pop-up Riser with 1/2" MPT Inlet Maximum 9" Extension (Minimum Pressure Required = 15 PSI) | Black | 25/100 | 13.1 | 21DI |
| HYPJ 250 | Hydro-Pop™ Pop-up Riser with 1/4" Compression Fit Inlet Maximum 5" Extension (Minimum Pressure Required = 15 PSI) | Black | 25/150 | 9.7 | 21DI |
| HYPJ 500 | Hydro-Pop™ Pop-up Riser with 1/2" MPT Inlet Maximum 5" Extension (Minimum Pressure Required = 15 PSI) | Black | 25/150 | 10.0 | 21DI |
| PUPS | Hydro-Pop™ Protector Sleeve (Use with TF, DAFT, MF, VF, AF) | Black | 25/100 | 4.3 | 21DI |

SINGLE-OUTLET DEVICES

Risers & Accessories (continued)



| Part No. | Description | Color | Bag Qty./ Box Qty. | Wt. per 100 (lbs.) | Product Class |
|----------|--|-------|-----------------------|-----------------------|------------------|
| R 6 | 6" Riser Extension (0.160" ID x 0.300" OD) | Black | 100/2,000 | 1.0 | 21DI |
| R 8 | 8" Riser Extension (0.160" ID x 0.300" OD) | Black | 100/1,500 | 1.4 | 21DI |
| R 12 | 12" Riser Extension (0.160" ID x 0.300" OD) | Black | 100/1,000 | 2.1 | 21DI |
| R 18 | 18" Riser Extension (0.160" ID x 0.300" OD) | Black | 100/600 | 3.1 | 21DI |
| RATT 6 | 6" Riser (0.160" ID) with Threaded Adapter | Black | 100/1,500 | 1.2 | 21DI |
| RATT 8 | 8" Riser (0.160" ID) with Threaded Adapter | Black | 100/1,500 | 1.5 | 21DI |
| RATT 12 | 12" Riser (0.160" ID) with Threaded Adapter | Black | 100/1,000 | 2.2 | 21DI |
| RATT 18 | 18" Riser (0.160" ID) with Threaded Adapter | Black | N/A/600 | 3.2 | 21DI |
| RABB 8 | 8" Riser (.160" ID) with Barbed Adapter | Black | 100/N/A | 1.5 | 21DI |
| RABB 12 | 12" Riser (.160" ID) with Barbed Adapter | Black | 100/N/A | 2.2 | 21DI |
| RABB 18 | 18" Riser (.160" ID) with Barbed Adapter | Black | 100/N/A | 3.2 | 21DI |
| RABT 6 | 6" Riser (0.160" ID) with Barbed Adapter | Black | 100/1,500 | 1.1 | 21DI |
| RABT 8 | 8" Riser (0.160" ID) with Barbed Adapter | Black | 100/1,500 | 1.5 | 21DI |
| RABT 12 | 12" Riser (0.160" ID) with Barbed Adapter | Black | 100/1,000 | 2.2 | 21DI |
| RABT 18 | 18" Riser (0.160" ID) with Barbed Adapter | Black | N/A/600 | 3.2 | 21DI |
| S5R6 | 6" Riser (R6) Pre-assembled onto Elbow Stake (S5) | Black | 100/400 | 2.5 | 21DI |
| S5R8 | 8" Riser (R8) Pre-assembled onto Elbow Stake (S5) | Black | 100/400 | 2.8 | 21DI |
| S5R12 | 12" Riser (R12) Pre-assembled onto Elbow Stake (S5) | Black | 100/600 | 3.6 | 21DI |
| CMAF 6 | 6" Riser Assembly (1/2" MIPT x 0.160" ID/0.300" OD PE Tubing) | Black | 100/200 | 2.8 | 21DI |
| CMAF 12 | 12" Riser Assembly (1/2" MIPT x 0.160" ID/0.300" OD PE Tubing) | Black | 100/200 | 3.6 | 21DI |

Stake Assemblies

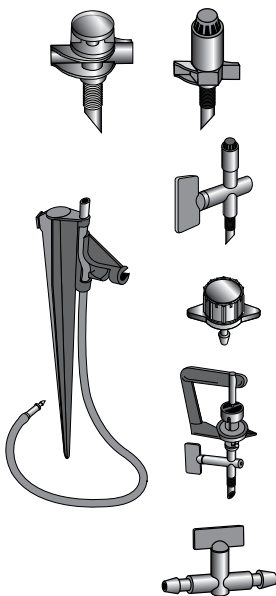

| Part No. | Description | Color | Bag Qty./ Box Qty. | Wt. per 100 (lbs.) | Product Class |
|-----------|---|---------|-----------------------|-----------------------|------------------|
| TA 24-1XY | Jet Assembly Comprising 2-Piece Hydro-Flo™ Jet, 24" Vinyl Tubing with Connector and S 12 Stake X=F (For 360°), H (For 180°), Q (For 90°) Y=3 (Black Base), 4 (Blue Base), 5 (Green Base) 6 (Red Base), 7 (White Base) | Specify | N/A/200 | 10.9 | 21DI |
| TA 24-2XY | Jet Assembly Comprising 1-Piece Hydro-Flo™ Jet, 24" Vinyl Tubing with Connector and S 12 Stake X=F (For 360°), H (For 180°), Q (For 90°) Y=3 (Black Orifice), 4 (Blue Orifice), 5 (Green Orifice) 6 (Green Orifice), 7 (Red Orifice) | Specify | N/A/200 | 10.8 | 21DI |
| TA 24-3X | Jet Assembly Comprising Adjustable Hydro-Flo™ Jet, 24" Vinyl Tubing with Connector and S 12 Stake X=F (For 360°), H (For 180°), Q (For 90°) | Black | N/A/200 | 11.2 | 21DI |
| TA 24-4 | Assembly Comprising 24" Vinyl Tubing, Connector and S 12 Stake (No Jet) | Black | N/A/200 | 10.7 | 21DI |
| TA 24-5 | Emitter Assembly Comprising Dial-a-Flo™ (DAFB 360), 24" Vinyl Tubing with Connector and S 12 Stake | Black | N/A/200 | 11.2 | 21DI |
| TA 24-6 | Jet Assembly Comprising Adjustable Micro-Flo™ Sprinkler (MFA), 24" Vinyl Tubing with Connector and S 12 Stake | Black | N/A/200 | 11.9 | 21DI |
| TA 24-7 | Assembly Comprising 24" Vinyl Tubing with Connector, Valve for Flow Adjustment and S 12 Stake | Black | N/A/200 | 11.1 | 21DI |

MULTI-OUTLET DEVICES

Fixed Flow Rate Devices



CUATRO-FLO™

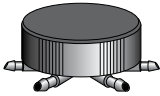

MAXI-FLO™

| Part No. | Description | Color | Bag Qty./ Box Qty. | Wt. per 100 (lbs.) | Product Class |
|--------------------|---|-------|-----------------------|-----------------------|------------------|
| Cuatro-Flo™ | | | | | |
| CFL 2 | 2 gph/Outlet Bubbler, 4 Swivel Barbed Outlets 1/2" FIPT, Pressure Compensating Cuatro-Flo™ Bubbler | Blue | 25/100 | 5.5 | 21DI |
| CFL 6 | 6 gph/Outlet Bubbler, 4 Swivel Barbed Outlets 1/2" FIPT, Pressure Compensating Cuatro-Flo™ Bubbler | Black | 25/100 | 5.5 | 21DI |
| CFL 10 | 10 gph/Outlet Bubbler, 4 Swivel Barbed Outlets 1/2" FIPT, Pressure Compensating Cuatro-Flo™ Bubbler | Red | 25/100 | 5.5 | 21DI |
| CFL 20 | 20 gph/Outlet Bubbler, 4 Swivel Barbed Outlets 1/2" FIPT, Pressure Compensating Cuatro-Flo™ Bubbler | Green | 25/100 | 5.5 | 21DI |
| Maxi-Flo™ | | | | | |
| MFBL 2 | 2 gph/Outlet, 1/2" FIPT, 6 Swivel Barbed Outlets, Compensating Maxi-Flo™ Bubbler | Blue | 25/100 | 10.2 | 21DI |
| MFBL 6 | 6 gph/Outlet, 1/2" FIPT, 6 Swivel Barbed Outlets, Compensating Maxi-Flo™ Bubbler | Black | 25/100 | 10.2 | 21DI |
| MFBL 10 | 10 gph/Outlet, 1/2" FIPT, 6 Swivel Barbed Outlets, Compensating Maxi-Flo™ Bubbler | Red | 25/100 | 10.2 | 21DI |
| MFBL 20 | 20 gph/Outlet, 1/2" FIPT, 6 Swivel Barbed Outlets, Compensating Maxi-Flo™ Bubbler | Green | 25/100 | 10.2 | 21DI |

Adjustable Flow Rate Devices

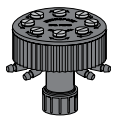

HYDROPORT™

| Part No. | Description | Color | Bag Qty./ Box Qty. | Wt. per 100 (lbs.) | Product Class |
|-------------------|--|-------|-----------------------|-----------------------|------------------|
| Hydroport™ | | | | | |
| HPAM 4 | 0-20 gph, Adjustable Flow, 1/2" FIPT, 4 Port Outlet Hydroport™ Adjustable Manifold | Black | 10/30 | 30.0 | 21DI |
| HPAM 8 | 0-20 gph, Adjustable Flow, 1/2" FIPT, 8 Port Outlet Hydroport™ Adjustable Manifold | Black | 10/30 | 30.0 | 21DI |

MULTI-OUTLET DEVICES

Bubbler Accessories

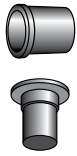

| Part No. | Description | Color | Bag Qty./ Box Qty. | Wt. per 100 (lbs.) | Product Class |
|----------|---|-------|-----------------------|-----------------------|------------------|
| PC 250 | Port Cap for Unused Outlets on Maxi-Flo™ (MFBL), Cuatro-Flo™ (CFL) | Black | 100/2,500 | 0.1 | 21DI |
| OP 250 | Outlet Plug for up to 2 Unused Outlets on Cuatro-Flo™ (CF) Drip Bubbler | Black | 100/2,000 | 0.1 | 21DI |

Spare Parts

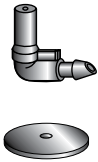

| Part No. | Description | Color | Bag Qty./ Box Qty. | Wt. per 100 (lbs.) | Product Class |
|----------|--|-------|-----------------------|-----------------------|------------------|
| ELI | Replacement Swivel Elbow for MFBL, CFL and PF Bubblers | Black | 10/100 | 0.2 | 21DI |
| D 80 H | Replacement Diaphragm for Cuatro-Flo™ (CF) Bubbler | Black | 10/20 | 0.1 | 21DI |



ADJUSTABLE EMITTERS – TECHNICAL INFORMATION





Hydro-Flo™ Jet (Adjustable) Model VF90 / VF180 / VF360

| Radius (Feet) | Discharge (gph) | | |
|---------------|-----------------|----------|----------|
| | VF90 | VF180 | VF360 |
| 1 FT. | — | — | 4.0 gph |
| 2 FT. | — | 6.5 gph | 5.7 gph |
| 3 FT. | 12.4 gph | 8.3 gph | 7.8 gph |
| 4 FT. | 14.5 gph | 10.2 gph | 10.5 gph |
| 5 FT. | 16.2 gph | 12.1 gph | 12.7 gph |
| 6 FT. | 18.6 gph | 14.5 gph | 14.8 gph |
| 7 FT. | 20.1 gph | 17.1 gph | 16.8 gph |
| 8 FT. | 23.0 gph | 21.8 gph | 18.0 gph |
| 9 FT. | 25.3 gph | 26.4 gph | 21.2 gph |
| 10 FT. | 27.6 gph | — | 23.5 gph |
| 11 FT. | 29.3 gph | — | 25.6 gph |
| 12 FT. | — | — | 27.6 gph |

Micro-Flo™
Micro-Sprinkler Model MFA

| Radius (Feet) | Discharge (gph) |
|---------------|-----------------|
| 1 FT. | — |
| 2 FT. | — |
| 3 FT. | 4.7 gph |
| 4 FT. | 6.6 gph |
| 5 FT. | 8.2 gph |
| 6 FT. | 9.8 gph |
| 7 FT. | 11.3 gph |
| 8 FT. | 13.2 gph |
| 9 FT. | 14.8 gph |
| 10 FT. | 16.4 gph |

Dial-a-Flo™ Emitters

| Part No. | Pattern |
|--|---|
| DAFB-360 / DAFT-360 DAFS-360 / DAFU-360 |  |
| DAFB-180 / DAFT-180 DAFS-180 / DAFU-180 |  |
| DAFB-FAN / DAFT-FAN DAFS-FAN / DAFU-FAN |  |
| DAFB-BUB / DAFT-BUB DAFS-BUB / DAFU-BUB |  |

Model DAFB-360 / DAFT-360 / DAFS-360 / DAFU-360

| Position | 20 PSI | | 30 PSI | | 40 PSI | |
|----------|-----------|--------|-----------|--------|-----------|--------|
| | Discharge | Radius | Discharge | Radius | Discharge | Radius |
| 0 | 0 gph | 0" | 0 gph | 0" | 0 gph | 0" |
| 1 | 1.8 gph | 0" | 2.3 gph | 0" | 2.7 gph | 0" |
| 2 | 2.4 gph | 0" | 3.1 gph | 0" | 3.5 gph | 2" |
| 3 | 3.0 gph | 0" | 3.9 gph | 2" | 4.6 gph | 3" |
| 4 | 3.7 gph | 2" | 4.8 gph | 3" | 5.6 gph | 4" |
| 5 | 4.4 gph | 3" | 5.7 gph | 4" | 6.7 gph | 5" |
| 6 | 5.0 gph | 4" | 6.5 gph | 6" | 7.6 gph | 8" |
| 7 | 5.6 gph | 5" | 7.2 gph | 7" | 8.4 gph | 10" |
| 8 | 6.2 gph | 6" | 8.1 gph | 9" | 9.1 gph | 12" |
| 1+ | 7.0 gph | 7" | 9.1 gph | 11" | 10.4 gph | 14" |
| 2+ | 7.9 gph | 9" | 10.3 gph | 12" | 11.7 gph | 16" |

Model DAFB-180 / DAFS-180 / DAFU-180

| Position | 20 PSI | | 30 PSI | | 40 PSI | |
|----------|-----------|--------|-----------|--------|-----------|--------|
| | Discharge | Radius | Discharge | Radius | Discharge | Radius |
| 0 | 0 gph | 0" | 0 gph | 0" | 0 gph | 0" |
| 1 | 1.8 gph | 4" | 2.3 gph | 6" | 2.7 gph | 9" |
| 2 | 2.4 gph | 7" | 3.1 gph | 10" | 3.5 gph | 13" |
| 3 | 3.0 gph | 9" | 3.9 gph | 13" | 4.6 gph | 18" |
| 4 | 3.7 gph | 11" | 4.8 gph | 16" | 5.6 gph | 24" |
| 5 | 4.4 gph | 13" | 5.7 gph | 19" | 6.7 gph | 30" |
| 6 | 5.0 gph | 15" | 6.5 gph | 24" | 7.6 gph | 35" |
| 7 | 5.6 gph | 18" | 7.2 gph | 27" | 8.4 gph | 40" |
| 8 | 6.2 gph | 21" | 8.1 gph | 30" | 9.1 gph | 44" |
| 1+ | 7.0 gph | 24" | 9.1 gph | 33" | 10.4 gph | 46" |
| 2+ | 7.9 gph | 26" | 10.3 gph | 36" | 11.7 gph | 48" |

Model DAFB-FAN / DAFS-FAN / DAFU-FAN

| Position | 20 PSI | | 30 PSI | | 40 PSI | |
|----------|-----------|--------|-----------|--------|-----------|--------|
| | Discharge | Radius | Discharge | Radius | Discharge | Radius |
| 0 | 0 gph | 0" | 0 gph | 0" | 0 gph | 0" |
| 1 | 3.8 gph | 0" | 5.0 gph | 0" | 5.8 gph | 0" |
| 2 | 6.3 gph | 0" | 8.2 gph | 12" | 9.5 gph | 18" |
| 3 | 9.5 gph | 18" | 12.4 gph | 24" | 14.3 gph | 36" |
| 4 | 10.6 gph | 21" | 13.6 gph | 30" | 16.0 gph | 42" |
| 5 | 11.4 gph | 24" | 14.8 gph | 36" | 17.1 gph | 48" |
| 6 | 12.1 gph | 27" | 15.6 gph | 42" | 18.1 gph | 54" |
| 7 | 13.0 gph | 30" | 16.5 gph | 48" | 19.0 gph | 57" |
| 8 | 13.5 gph | 33" | 17.1 gph | 52" | 20.0 gph | 59" |
| 1+ | 14.0 gph | 35" | 18.1 gph | 54" | 20.9 gph | 61" |
| 2+ | 14.3 gph | 36" | 18.7 gph | 56" | 21.6 gph | 62" |

Model DAFB-BUB / DAFS-BUB / DAFU-BUB / DAFT-BUB

| Position | 20 PSI | | 30 PSI | | 40 PSI | |
|----------|-----------|--------|-----------|--------|-----------|--------|
| | Discharge | Radius | Discharge | Radius | Discharge | Radius |
| 0 | 0 gph | 0" | 0 gph | 0" | 0 gph | 0" |
| 1 | 3.8 gph | 0" | 5.0 gph | 0" | 5.8 gph | 0" |
| 2 | 6.3 gph | 0" | 8.2 gph | 0" | 9.5 gph | 0" |
| 3 | 9.5 gph | 0" | 12.4 gph | 0" | 14.3 gph | 1" |
| 4 | 10.6 gph | 0" | 13.6 gph | 1" | 16.0 gph | 2" |
| 5 | 11.4 gph | 1" | 14.8 gph | 1" | 17.1 gph | 3" |
| 6 | 12.1 gph | 1" | 15.6 gph | 2" | 18.1 gph | 3" |
| 7 | 13.0 gph | 1" | 16.5 gph | 2" | 19.0 gph | 4" |
| 8 | 13.5 gph | 1" | 17.1 gph | 3" | 20.0 gph | 4" |
| 1+ | 14.0 gph | 2" | 18.1 gph | 3" | 20.9 gph | 5" |
| 2+ | 14.3 gph | 2" | 18.7 gph | 4" | 21.6 gph | 5" |

TECHNICAL INFORMATION – DRIP & MICRO-SPRAY EMITTERS

Discharge Rates (GPH)

| Model | Part No. | 10 PSI | 15 PSI | 20 PSI | 25 PSI | 30 PSI | 40 PSI | 60 PSI | 80 PSI |
|--------------------|----------|---------------|----------------|----------------|----------------|----------------|----------------|----------------|----------|
| Maxi-Flo™ Bubbler | MFBL 2 | | | 2.2 gph | 2.3 gph | 2.4 gph | 2.5 gph | 2.6 gph | 2.6 gph |
| | MFBL 6 | | | 5.7 gph | 6.3 gph | 6.9 gph | 7.7 gph | 9.1 gph | 9.5 gph |
| | MFBL 10 | | | 9.0 gph | 9.7 gph | 10.4 gph | 11.6 gph | 14.1 gph | 15.3 gph |
| | MBFL 20 | | | 16.4 gph | 17.7 gph | 19.0 gph | 22.1 gph | 26.7 gph | 28.2 gph |
| Hydroport™ | HPAM 4 | 7.0 gph (Max) | 10.0 gph (Max) | 12.0 gph (Max) | 13.0 gph (Max) | 14.0 gph (Max) | 16.0 gph (Max) | 20.0 gph (Max) | |
| | HPAM 8 | 7.0 gph (Max) | 10.0 gph (Max) | 12.0 gph (Max) | 13.0 gph (Max) | 14.0 gph (Max) | 16.0 gph (Max) | 20.0 gph (Max) | |
| Super-Flo™ Emitter | TAE 10 | 0.56 gph | 0.70 gph | 0.80 gph | 0.89 gph | 0.97 gph | | | |

Maximum Recommended Length of Run (Feet)

Hydro-Flo™ Jets, Micro-Flo™ Micro-Sprinkler

| Orifice | Initial Pressure | I.D. of Tubing (inches) | | | | | | | | | | | |
|---------|------------------|-------------------------------------|-------|--------|-------|-------|--------|-------|-------|--------|-------|-------|--------|
| | | .600" | .820" | 1.040" | .600" | .820" | 1.040" | .600" | .820" | 1.040" | .600" | .820" | 1.040" |
| | | Average Spacing Between Jets (feet) | | | | | | | | | | | |
| | | | 6' | | | 9' | | | 12' | | | 15' | |
| 0.030" | 20 PSI | 210' | 400' | 620' | 275' | 520' | 810' | 340' | 645' | 1,000' | 385' | 730' | 1,130' |
| 0.040" | 20 PSI | 140' | 265' | 415' | 185' | 350' | 545' | 225' | 425' | 600' | 250' | 475' | 735' |
| 0.050" | 20 PSI | 110' | 210' | 325' | 145' | 275' | 425' | 175' | 330' | 515' | 195' | 370' | 575' |
| 0.060" | 20 PSI | 85' | 160' | 250' | 110' | 210' | 330' | 135' | 255' | 400' | 150' | 290' | 450' |

Tri-Flo™ Spray Stick









| Model | Flow Node | Initial Pressure | I.D. of Tubing (inches) | | | | | | | | | |
|--------|-----------|------------------|---|-------|-------|-------|-------|-------|-------|-------|-------|-------|
| | | | .600" | .820" | .600" | .820" | .600" | .820" | .600" | .820" | .600" | .820" |
| | | | Average Spacing Between Spray Sticks (inches) | | | | | | | | | |
| | | | 12" | | 24" | | 36" | | 48" | | 60" | |
| TFS 9 | Low | 20 PSI | 75' | 140' | 115' | 220' | 150' | 285' | 180' | 340' | 210' | 400' |
| | Medium | 20 PSI | 55' | 105' | 85' | 160' | 110' | 205' | 135' | 250' | 155' | 290' |
| | High | 20 PSI | 45' | 85' | 70' | 130' | 90' | 170' | 110' | 205' | 125' | 235' |
| TFS 16 | Low | 20 PSI | 55' | 105' | 85' | 160' | 110' | 205' | 135' | 250' | 155' | 290' |
| | Medium | 20 PSI | 45' | 85' | 70' | 130' | 90' | 170' | 110' | 205' | 125' | 235' |
| | High | 20 PSI | 35' | 65' | 55' | 105' | 75' | 140' | 90' | 170' | 105' | 200' |

TECHNICAL INFORMATION – MICRO SPRAY EMITTERS

Discharge Rates (GPH) / Radius (feet)

| Model | Part No. | 15 PSI | | 20 PSI | | 25 PSI | | 30 PSI | | 40 PSI | | 45 PSI | |
|----------------------------|-----------------|-----------|----------|-----------|----------|-----------|----------|-----------|--------|-----------|--------|-----------|--------|
| | | Discharge | Radius | Discharge | Radius | Discharge | Radius | Discharge | Radius | Discharge | Radius | Discharge | Radius |
| Hydro-Flo™ Jet | TFB 30 (Black) | 4.8 gph | 5.0' | 5.5 gph | 6.0' | 6.2 gph | 7.0' | 6.8 gph | 8.0' | | | | |
| | TFB 40 (Blue) | 8.8 gph | 7.0' | 10.4 gph | 8.0' | 11.7 gph | 8.0' | 12.9 gph | 9.0' | | | | |
| | TFB 50 (Green) | 13.8 gph | 8.0' | 15.8 gph | 9.0' | 17.7 gph | 9.0' | 19.5 gph | 10.0' | | | | |
| | TFB 60 (Red) | 20.0 gph | 8.0' | 23.3 gph | 9.0' | 26.3 gph | 10.0' | 28.9 gph | 11.0' | | | | |
| | TFB 70 (White) | 32.9 gph | 9.0' | 37.6 gph | 10.0' | 42.5 gph | 11.0' | 46.6 gph | 12.0' | | | | |
| | TF 336 (Black) | 4.8 gph | 4.0' | 5.5 gph | 4.5' | 6.2 gph | 5.0' | 6.8 gph | 5.0' | | | | |
| | TF 436 (Blue) | 8.8 gph | 4.5' | 10.4 gph | 5.0' | 11.7 gph | 5.5' | 12.9 gph | 5.5' | | | | |
| | TF 536 (Green) | 13.8 gph | 5.0' | 15.8 gph | 5.5' | 17.7 gph | 6.0' | 19.5 gph | 6.0' | | | | |
| | TF 636 (Red) | 20.0 gph | 5.0' | 23.3 gph | 5.5' | 26.3 gph | 6.0' | 28.9 gph | 6.5' | | | | |
| | TF 318 (Black) | 4.8 gph | 3.0' | 5.5 gph | 3.5' | 6.2 gph | 4.0' | 6.8 gph | 4.5' | | | | |
| | TF 418 (Blue) | 8.8 gph | 3.5' | 10.4 gph | 4.0' | 11.7 gph | 4.5' | 12.9 gph | 5.0' | | | | |
| | TF 518 (Green) | 13.8 gph | 4.0' | 15.8 gph | 4.5' | 17.7 gph | 5.0' | 19.5 gph | 5.5' | | | | |
| | TF 618 (Red) | 20.0 gph | 4.5' | 23.3 gph | 5.0' | 26.3 gph | 5.5' | 28.9 gph | 6.0' | | | | |
| | TF 39 (Black) | 4.8 gph | 4.0' | 5.5 gph | 4.5' | 6.2 gph | 5.5' | 6.8 gph | 6.0' | | | | |
| | TF 49 (Blue) | 8.8 gph | 4.5' | 10.4 gph | 5.0' | 11.7 gph | 5.5' | 12.9 gph | 6.0' | | | | |
| | TF 59 (Green) | 13.8 gph | 4.5' | 15.8 gph | 5.5' | 17.7 gph | 6.0' | 19.5 gph | 6.5' | | | | |
| TF 69 (Red) | 20.2 gph | 5.0' | 23.3 gph | 5.5' | 26.3 gph | 6.0' | 28.9 gph | 6.5' | | | | | |
| AF 3xx (Black) | 5.7 gph | 5.0' | 6.5 gph | 6.0' | 7.3 gph | 7.0' | 8.0 gph | 8.0' | | | | | |
| Micro-Flo™ Micro-Sprinkler | MF 35 (Orange) | 6.6 gph | 6.0' | 7.7 gph | 7.0' | 8.6 gph | 8.0' | 9.4 gph | 8.0' | | | | |
| | MF 40 (Blue) | 8.6 gph | 7.0' | 10.0 gph | 8.0' | 11.3 gph | 9.0' | 12.4 gph | 9.0' | | | | |
| | MF 50 (Green) | 13.6 gph | 8.0' | 16.0 gph | 9.0' | 17.9 gph | 10.0' | 19.7 gph | 10.0' | | | | |
| Tri-Flo™ Spray Stick | TFS 9 - Low | 4.8 gph | 1.0' | 5.3 gph | 1.5' | 6.0 gph | 2.0' | | | | | | |
| | TFS 9 - Medium | 7.1 gph | 1.5' | 7.9 gph | 2.0' | 9.0 gph | 2.5' | | | | | | |
| | TFS 9 - High | 9.5 gph | 3.0' | 10.6 gph | 3.5' | 12.0 gph | 4.0' | | | | | | |
| | TFS 16 - Low | 7.1 gph | 1.5' | 7.9 gph | 2.0' | 9.0 gph | 2.5' | | | | | | |
| | TFS 16 - Medium | 9.5 gph | 2.5' | 10.6 gph | 3.0' | 12.0 gph | 3.5' | | | | | | |
| TFS 16 - High | 14.3 gph | 3.5' | 15.9 gph | 4.0' | 18.0 gph | 4.5' | | | | | | | |
| Misti-Flo™ Mister | MFM 4 | 3.7 gph | 4.5' | 4.4 gph | 5.0' | 5.0 gph | 5.5' | 5.5 gph | 6.0' | 5.9 gph | 6.5' | 6.3 gph | 7.0' |

PROFESSIONAL IRRIGATION

| Model | Part No. | Pattern | Model | Part No. | Pattern |
|----------------|---|---|----------------------|----------|---|
| Hydro-Flo™ Jet | TFC 360 |  | Tri-Flo™ Spray Stick | TFS 9 |  |
| | TFC 300 |  | | TFS 16 |  |
| | TFC 180, TF 318, TF 418, TF 518, TF 618 |  | | | |
| | TFC 90, TF 39, TF 49, TF 59, TF 69 |  | | | |
| | TF 336, TF 436, TF 536, TF 636 |  | | | |
| | TFC 33 |  | | | |

Flushing Characteristics of Compensating Emitters*

| Nominal Flow | Peak Flush Flow | Peak Flush Pressure |
|--------------|-----------------|---------------------|
| 1 | 1.6 gph | 3 PSI |
| 2 | 3.0 gph | 3 PSI |

*Includes Mono Flo™ and Uni Flo™ Classic emitters.

FITTINGS & ACCESSORIES

Smart-Loc™ Multi-Diameter Fittings

PROFESSIONAL IRRIGATION



| Part No. | Description | Color | Bag Qty./ Box Qty. | Wt. per 100 (lbs.) | Product Class |
|------------|---|-------|-----------------------|-----------------------|------------------|
| CMAP 75-18 | 3/4" Male Pipe Thread Adaptor (Fits 16mm, 17mm & 18mm Tubing) | Black | 25/250 | 0.375 | 21DI |
| SLC 18 | Coupling (Fits 16mm, 17mm & 18mm Tubing) | Black | 25/250 | 0.375 | 21DI |
| CEP 18 | End Plug (Fits 16mm, 17mm & 18mm Tubing) | Black | 25/250 | 0.375 | 21DI |
| CEL 18 | Elbow (Fits 16mm, 17mm & 18mm Tubing) | Black | 25/250 | 0.375 | 21DI |
| CMAH 18 | Male Hose Thread Adaptor (Fits 16mm, 17mm & 18mm Tubing) | Black | 25/250 | 0.375 | 21DI |
| CSA 18 | Swivel Adaptor Female Hose Thread (Fits 16mm, 17mm & 18mm Tubing) | Black | 25/250 | 0.375 | 21DI |
| CMA5-18 | 1/2" Male Pipe Thread Adaptor (Fits 16mm, 17mm & 18mm Tubing) | Black | 25/250 | 0.375 | 21DI |
| CT 18 | Tee (Fits 16mm, 17mm & 18mm Tubing) | Black | 25/250 | 0.375 | 21DI |

Specifications

- Connect 16mm-18mm 1/2" polyethylene tubing
- Reduces Inventory
- Ideal for Tubing Repairs
- Durable Under the Most Demanding Conditions
- 8-80 PSI
- Accepts tubing OD of .620" to .710" (16mm-18mm)
- Made from UV-resistant, high-quality ABS material
- Reusable design – Tubing can be inserted & removed without damaging the fitting

WORKS WITH

DURA FLO™ DRIPLINE

and parts A620, A660, A700, A710 Supply Tubing



FITTINGS & ACCESSORIES

17MM Insert Fittings



| Part No. | Description | Color | Bag Qty./ Box Qty. | Wt. per 100 (lbs.) | Product Class |
|-----------|------------------------------------|-------|-----------------------|-----------------------|------------------|
| BTMA 1750 | 17mm Insert x 1/2" MPT Adapter | Brown | 10/bag | 1.71 | 21DI |
| BTMA 1775 | 17mm Insert x 3/4" MPT Adapter | Brown | 10/bag | 2.40 | 21DI |
| BV 17 | 17mm Insert Ball Valve | Black | – | 4.10 | 21DI |
| C 17 | 17mm Insert Coupling | Brown | 25/bag | 2.25 | 21DI |
| CX 17 | 17mm Insert Cross | Brown | – | – | 21DI |
| EL 17 | 17mm Insert Elbow | Brown | 25/bag | 1.32 | 21DI |
| T 17 | 17mm Insert Tee | Brown | 25/bag | 1.73 | 21DI |
| TMA 1750 | 17mm Insert Tee x 1/2" MPT Adapter | Brown | – | 2.35 | 21DI |
| YMA 1775 | 17mm Insert Y x 3/4" MPT Adapter | Brown | – | 4.15 | 21DI |

PROFESSIONAL IRRIGATION

FITTINGS & ACCESSORIES

Compression Solvent Weld Adapters

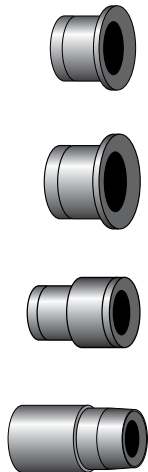

| Part No. | Description | Color | Bag Qty./ Box Qty. | Wt. per 100 (lbs.) | Product Class |
|----------------------------------|---|--------|-----------------------|-----------------------|------------------|
| CA 250 | Compression Adapter (1/2" Slip x .250" OD Tubing) | Orange | 100/2,000 | 0.6 | 21DI |
| Use w/A 250 Tubing (1/4" Tubing) | | | | | |
| CA 300 | Compression Adapter (1/2" Slip x .307" OD Tubing) | Grey | 100/2,000 | 0.6 | 21DI |
| CA 500 | Compression Adapter (1/2" Slip x .455" to .480" OD Tubing) | Red | 100/2,000 | 0.6 | 21DI |
| Use w/A 455 Tubing (3/8" Tubing) | | | | | |
| CA 600 | Compression Adapter (1/2" Slip x .610" to .640" OD Tubing) | Green | 100/2,000 | 0.5 | 21DI |
| Use w/A 620 Tubing (1/2" Tubing) | | | | | |
| CA 700 | Compression Adapter (1/2" Slip x .680" to .704" OD Tubing) | Black | 100/2,000 | 0.4 | 21DI |
| Use w/A 700 Tubing (1/2" Tubing) | | | | | |
| CA 710 | Compression Adapter (1/2" Slip x .704" to .710" OD Tubing) | Blue | 100/2,000 | 0.4 | 21DI |
| Use w/A 710 Tubing (1/2" Tubing) | | | | | |
| CA 800 | Compression Adapter (3/4" Slip x .830" OD Tubing) | Black | 100/1,000 | 0.8 | 21DI |
| CA 900 | Compression Adapter (3/4" Slip x .940" OD Tubing) | Grey | 100/1,000 | 0.8 | 21DI |
| Use w/A 940 Tubing (3/4" Tubing) | | | | | |
| LCA 700 | 1/2" Compression Adapter (Long) (1/2" Slip x .680" to .704" OD Tubing) | Black | 50/800 | 1.3 | 21DI |
| Use w/A 700 Tubing (1/2" Tubing) | | | | | |
| LCA 710 | 1/2" Compression Adapter (Long) (1/2" Slip x .704" to .710" OD Tubing) | Blue | 50/800 | 1.3 | 21DI |
| Use w/A 710 Tubing (1/2" Tubing) | | | | | |
| SA 700 | Socket Adapter - ID Bonds Over 1/2" PVC Pipe, OD Bonds into 3/4" PVC Socket | Black | 100/600 | 1.5 | 21DI |
| Use w/A 700 Tubing (1/2" Tubing) | | | | | |

Compression Fittings

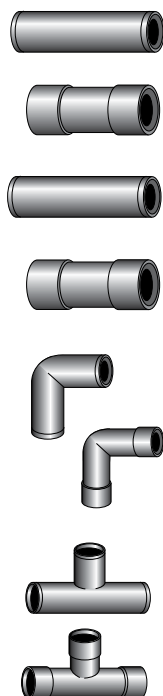

| Part No. | Description | Color | Bag Qty./ Box Qty. | Wt. per 100 (lbs.) | Product Class |
|----------|---|------------|-----------------------|-----------------------|------------------|
| CC 600 | Compression Coupling (Fits .610" to .640" OD Tubing i.e. A 620) | Green | 25/1,000 | 2.8 | 21DI |
| CC 700 | Compression Coupling (Fits .680" to .704" OD Tubing i.e. A 700) | Black | 25/1,000 | 2.8 | 21DI |
| CC 710 | Compression Coupling (Fits .704" to .710" OD Tubing i.e. A 710) | Blue | 25/1,000 | 2.7 | 21DI |
| CC 800 | Compression Coupling (Fits .830" OD Tubing) | Black | 25/500 | 6.0 | 21DI |
| CC 900 | Compression Coupling (Fits .940" OD Tubing i.e. A 940) | Grey | 25/500 | 5.7 | 21DI |
| RCC 6070 | Reducing Compression Coupling (600 Series to 700 Series) | Green | 25/1,000 | 2.9 | 21DI |
| RCC 6071 | Reducing Compression Coupling (600 Series to 710 Series) | Blue | 25/1,000 | 2.8 | 21DI |
| RCC 7071 | Reducing Compression Coupling (700 Series to 710 Series) | Blue | 25/1,000 | 2.7 | 21DI |
| RCC 8090 | Reducing Compression Coupling (800 Series to 900 Series) | Black/Grey | 25/500 | 5.7 | 21DI |
| RCC 7090 | Reducing Compression Coupling (700 Series to 900 Series) | Black/Grey | 25/500 | 4.0 | 21DI |
| CEL 600 | Compression Elbow (.610" to .640" OD Tubing i.e. A 620) | Green | 25/800 | 3.9 | 21DI |
| CEL 700 | Compression Elbow (.680" to .704" OD Tubing i.e. A 700) | Black | 25/800 | 3.7 | 21DI |
| CEL 710 | Compression Elbow (.704" to .710" OD Tubing i.e. A 710) | Blue | 25/800 | 3.7 | 21DI |
| CEL 800 | Compression Elbow (Fits .830" OD Tubing) | Black | 25/500 | 6.1 | 21DI |
| CEL 900 | Compression Elbow (Fits .940" OD Tubing i.e. A 940) | Grey | 25/500 | 5.9 | 21DI |
| CT 600 | Compression Tee (.610" to .640" OD Tubing i.e. A 620) | Green | 15/480 | 5.5 | 21DI |
| CT 700 | Compression Tee (.680" to .704" OD Tubing i.e. A 700) | Black | 15/480 | 5.2 | 21DI |
| CT 710 | Compression Tee (.704" to .710" OD Tubing i.e. A 710) | Blue | 15/480 | 5.2 | 21DI |
| CT 800 | Compression Tee (Fits .830" OD Tubing) | Black | 25/300 | 8.7 | 21DI |
| CT 900 | Compression Tee (Fits .940" OD Tubing i.e. A 940) | Grey | 25/300 | 8.4 | 21DI |

FITTINGS & ACCESSORIES

Compression End Caps

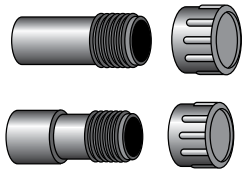

| Part No. | Description | Color | Bag Qty./ Box Qty. | Wt. per 100 (lbs.) | Product Class |
|----------|--|-------|-----------------------|-----------------------|------------------|
| CEP 600 | End Plug with Cap (Fits .610" to .640" OD Tubing i.e. A 620) | Green | 25/800 | 4.0 | 21DI |
| CEP 700 | End Plug with Cap (Fits .680" to .704" OD Tubing i.e. A 700) | Black | 25/800 | 4.0 | 21DI |
| CEP 710 | End Plug with Cap (Fits .704" to .710" OD Tubing i.e. A 710) | Blue | 25/800 | 4.0 | 21DI |
| CEP 900 | End Plug with Cap (Fits .940" OD Tubing i.e. A 940) | Grey | 25/600 | 5.1 | 21DI |

Note: All caps are unscrewing caps.

Compression Male Adapters

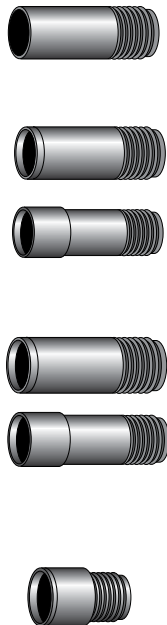

| Part No. | Description | Color | Bag Qty./ Box Qty. | Wt. per 100 (lbs.) | Product Class |
|-----------|---|-------|-----------------------|-----------------------|------------------|
| CMAH | 3/4" MHT x 1/2" Slip Socket Adapter | Black | 50/1,000 | 1.8 | 21DI |
| CMAH 600 | 3/4" MHT Adapter (Fits .610" to .640" OD Tubing i.e. A 620) | Green | 50/1,000 | 2.3 | 21DI |
| CMAH 700 | 3/4" MHT Adapter (Fits .680" to .704" OD Tubing i.e. A 700) | Black | 50/1,000 | 2.2 | 21DI |
| CMAH 710 | 3/4" MHT Adapter (Fits .704" to .710" OD Tubing i.e. A 710) | Blue | 50/1,000 | 2.2 | 21DI |
| CMAH 800 | 3/4" MHT Adapter (Fits .830" OD Tubing) | Black | 25/700 | 3.4 | 21DI |
| CMAH 900 | 3/4" MHT Adapter (Fits .940" OD Tubing i.e. A 940) | Grey | 25/700 | 3.3 | 21DI |
| CMAP 600 | 3/4" MIPT Adapter (Fits .610" to .640" OD Tubing) | Green | 50/1,000 | 2.2 | 21DI |
| CMAP 700 | 3/4" MIPT Adapter (Fits .680" to .704" OD Tubing) | Black | 50/1,000 | 2.2 | 21DI |
| CMAP 710 | 3/4" MIPT Adapter (Fits .704" to .710" OD Tubing) | Blue | 50/1,000 | 2.1 | 21DI |
| CMAP 800 | 3/4" MIPT Adapter (Fits .830" OD Tubing) | Black | 25/800 | 3.5 | 21DI |
| CMAP 900 | 3/4" MIPT Adapter (Fits .940" OD Tubing) | Grey | 25/800 | 3.3 | 21DI |
| CMAP5-600 | 1/2" MIPT Adapter (Fits .610" to .640" OD Tubing) | Green | 50/1,000 | 1.6 | 21DI |
| CMAP5-700 | 1/2" MIPT Adapter (Fits .680" to .704" OD Tubing) | Black | 50/1,000 | 1.5 | 21DI |
| CMAP5-710 | 1/2" MIPT Adapter (Fits .704" to .710" OD Tubing) | Blue | 50/1,000 | 1.5 | 21DI |

FITTINGS & ACCESSORIES

Compression 3/4" Swivel Fittings

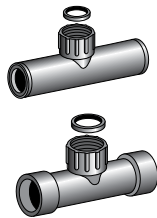
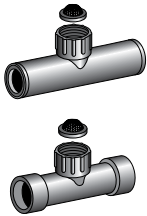
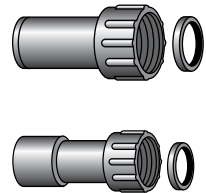
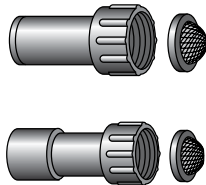

| Part No. | Description | Color | Bag Qty./ Box Qty. | Wt. per 100 (lbs.) | Product Class |
|--|--|-------|-----------------------|-----------------------|------------------|
| CSA 600 | 3/4" FHT Swivel Adapter (Fits .610" to .640" OD Tubing i.e. A 620) | Green | 25/800 | 3.8 | 21DI |
| CSA 700 | 3/4" FHT Swivel Adapter (Fits .680" to .704" OD Tubing i.e. A 700) | Black | 25/800 | 3.8 | 21DI |
| CSA 710 | 3/4" FHT Swivel Adapter (Fits .704" to .710" OD Tubing i.e. A 710) | Blue | 25/800 | 3.6 | 21DI |
| CSA 800 | 3/4" FHT Swivel Adapter (Fits .830" OD Tubing) | Black | 25/600 | 5.0 | 21DI |
| CSA 900 | 3/4" FHT Swivel Adapter (Fits .940" OD Tubing i.e. A 940) | Grey | 25/600 | 4.8 | 21DI |
| Note: All adapters include screens as shown. | | | | | |
| CSAW 600 | 3/4" FHT Swivel Adapter w/Washer (Fits .610" to .640" OD Tubing) | Green | 25/800 | 3.6 | 21DI |
| CSAW 700 | 3/4" FHT Swivel Adapter w/Washer (Fits .680" to .704" OD Tubing) | Black | 25/800 | 3.5 | 21DI |
| CSAW 710 | 3/4" FHT Swivel Adapter w/Washer (Fits .704" to .710" OD Tubing) | Blue | 25/800 | 3.5 | 21DI |
| CSAW 800 | 3/4" FHT Swivel Adapter w/Washer (Fits .830" OD Tubing) | Black | 25/600 | 4.7 | 21DI |
| CSAW 900 | 3/4" FHT Swivel Adapter w/Washer (Fits .940" OD Tubing) | Grey | 25/600 | 4.7 | 21DI |
| CST 600 | 3/4" FHT Swivel Tee w/Screen (Fits .610" to .640" OD Tubing) | Green | 15/480 | 6.4 | 21DI |
| ST 700 | 3/4" FHT Swivel Tee w/Screen (Fits .680" to .704" OD Tubing) | Black | 15/480 | 6.2 | 21DI |
| CST 710 | 3/4" FHT Swivel Tee w/Screen (Fits .704" to .710" OD Tubing) | Blue | 15/480 | 6.3 | 21DI |
| CST 900 | 3/4" FHT Swivel Tee w/Screen (Fits .940" OD Tubing) | Grey | 25/300 | 8.3 | 21DI |
| CSTW 600 | 3/4" FHT Swivel Tee w/Washer (Fits .610" to .640" OD Tubing) | Green | 15/480 | 6.0 | 21DI |
| CSTW 700 | 3/4" FHT Swivel Tee w/Washer (Fits .680" to .704" OD Tubing) | Black | 15/480 | 5.9 | 21DI |
| CSTW 710 | 3/4" FHT Swivel Tee w/Washer (Fits .704" to .710" OD Tubing) | Blue | 15/480 | 6.0 | 21DI |
| CSTW 900 | 3/4" FHT Swivel Tee w/Washer (Fits .940" OD Tubing) | Grey | 25/300 | 8.0 | 21DI |
| CSEL 700 | 3/4" FHT Swivel Elbow w/Screen (Fits .680" to .704" OD Tubing) | Black | 25/500 | 4.7 | 21DI |
| CSEL 710 | 3/4" FHT Swivel Elbow w/Screen (Fits .704" to .710" OD Tubing) | Blue | 25/500 | 4.7 | 21DI |
| CSELW 600 | 3/4" FHT Swivel Elbow w/Washer (Fits .610" to .640" OD Tubing) | Green | 25/500 | 4.4 | 21DI |
| CSELW 700 | 3/4" FHT Swivel Elbow w/Washer (Fits .680" to .704" OD Tubing) | Black | 25/500 | 4.4 | 21DI |
| CSELW 710 | 3/4" FHT Swivel Elbow w/Washer (Fits .704" to .710" OD Tubing) | Blue | 25/500 | 4.4 | 21DI |

FITTINGS & ACCESSORIES

Micro Fittings

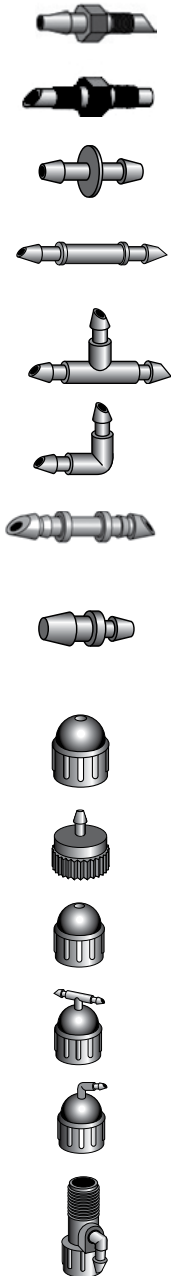

| Part No. | Description | Color | Bag Qty./ Box Qty. | Wt. per 100 (lbs.) | Product Class |
|-------------------------------|--|-------|-----------------------|-----------------------|------------------|
| BT 250 | Adapter - Barb x Thread (Fits 0.160" ID - 0.170" ID Tubing) | Black | 100/2,000 | 0.1 | 21DI |
| Use with A 250 (1/4" tubing). | | | | | |
| TT 250 | Adapter - Thread x Thread (Fits 0.160" ID - 0.170" ID Tubing) | Black | 100/2,000 | 0.1 | 21DI |
| Use with A 250 (1/4" tubing). | | | | | |
| C 125 | Connector (Barb x Barb) (Fits 0.125" ID Tubing) | Black | 100/5,000 | 0.1 | 21DI |
| Use with A 185 (1/8" tubing). | | | | | |
| C 250 | Connector (Barb x Barb) (Fits 0.160" ID - 0.170" ID Tubing) | Black | 100/10,000 | 0.1 | 21DI |
| Use with A 250 (1/4" tubing). | | | | | |
| T 250 | Tee (Barb x Barb x Barb) (Fits 0.160" ID - 0.170" ID Tubing) | Black | 100/3,000 | 0.2 | 21DI |
| Use with A 250 (1/4" tubing). | | | | | |
| EL 250 | Elbow (Barb x Barb x Barb) (Fits 0.160" ID - 0.170" ID Tubing) | Black | 100/3,000 | 0.2 | 21DI |
| Use with A 250 (1/4" tubing). | | | | | |
| DBC 250 | Double Barbed Connector (Barbed x Barbed) (Fits 0.160" ID - 0.170" ID Tubing) | Black | 100/10,000 | 0.1 | 21DI |
| Use with A 250 (1/4" tubing). | | | | | |
| GP 2 | Dual Goof Plug (20/Rack) | Black | 100/10,000 | 0.1 | 21DI |
| GP 2B | Bulk Packaged 2-Sided Goof Plug | Black | N/A/10,000 | 0.1 | 21DI |
| Use with A 250 (1/4" tubing). | | | | | |
| SAJ | Adapter for Hydro-Flo™ (page 102), Dial-a-Flo™ (page 101), Micro-Flo™ Jets (page 103) (1/2" FIPT x 10-32 NPT) | Black | 100/400 | 1.5 | 21DI |
| SAT | Adapter for A 220 and A 250 Tubing (page 119) (1/2" FIPT x Barb) | Black | 100/400 | 1.1 | 21DI |
| REA | Adapter for 1/4" Barbed Drip Emitter (1/2" FIPT x Emitter Socket dapter) | Black | 100/400 | 1.3 | 21DI |
| ST 250 | Adapter for Dura-Flo™ JR (page 97) and 1/4" Tubing (page XX) (1/2" FIPT x 1/4" Barbed Swivel Tee) | Black | 100/300 | 1.4 | 21DI |
| SEL 250 | Adapter for Dura-Flo™ JR (page 97) and 1/4" Tubing (page XX) (1/2" FIPT x 1/4" Barbed Swivel Elbow) | Black | 100/300 | 1.4 | 21DI |
| RA 250 | Riser Extension Adapter (1/2" FIPT x 1/2" MIPT x 1/4" Barb) | Black | 25/100 | 2.6 | 21DI |

FITTINGS & ACCESSORIES

Compression 1/2" Riser Adapters

PROFESSIONAL IRRIGATION



| Part No. | Description | Color | Bag Qty./ Box Qty. | Wt. per 100 (lbs.) | Product Class |
|--------------------------|---|-------|-----------------------|-----------------------|------------------|
| RSF 100 | 1/2" Riser Swivel Filter with 100 Mesh Stainless Steel Screen – Maximum Flow 2 gpm (1/2" MIPT x 1/2" FIPT Swivel) | Black | 25/100 | 3.2 | 21DI |
| RS | 1/2" Riser Swivel (1/2" MIPT x 1/2" FIPT Swivel) | Black | 25/100 | 3.0 | 21DI |
| RST 700 | 1/2" Riser Swivel Tee w/100 Mesh Filter (Fits .680" to .704" OD Tubing i.e. A 700) | Black | 40/80 | 6.3 | 21DI |
| RST 710 | 1/2" Riser Swivel Tee w/100 Mesh Filter (Fits .704" to .710" OD Tubing i.e. A 710) | Blue | 40/80 | 6.3 | 21DI |
| Products include filter. | | | | | |
| RSTW 600 | 1/2" Riser Swivel Tee (Fits .610" to .640" OD Tubing) | Green | 40/80 | 5.9 | 21DI |
| RSTW 700 | 1/2" Riser Swivel Tee (Fits .680" to .704" OD Tubing) | Black | 40/80 | 6.1 | 21DI |
| RSTW 710 | 1/2" Riser Swivel Tee (Fits .704" to .710" OD Tubing) | Blue | 40/80 | 6.0 | 21DI |
| Products include washer. | | | | | |
| RSEL 600 | 1/2" Riser Swivel Elbow w/100 Mesh Filter (Fits .610" to .640" OD Tubing) | Green | 50/100 | 5.2 | 21DI |
| RSEL 700 | 1/2" Riser Swivel Elbow w/100 Mesh Filter (Fits .680" to .704" OD Tubing) | Black | 50/100 | 5.0 | 21DI |
| RSEL 710 | 1/2" Riser Swivel Elbow w/100 Mesh Filter (Fits .704" to .710" OD Tubing) | Blue | 50/100 | 5.0 | 21DI |
| Products include filter. | | | | | |
| RSELW 500 | 1/2" Riser Swivel Elbow (Fits .455" to .480" OD Tubing) | Red | 50/100 | 4.8 | 21DI |
| RSELW 600 | 1/2" Riser Swivel Elbow (Fits .610" to .640" OD Tubing) | Green | 50/100 | 4.8 | 21DI |
| RSELW 700 | 1/2" Riser Swivel Elbow (Fits .680" to .704" OD Tubing) | Black | 50/100 | 4.8 | 21DI |
| RSELW 710 | 1/2" Riser Swivel Elbow (Fits .704" to .710" OD Tubing) | Blue | 50/100 | 4.8 | 21DI |
| Products include washer. | | | | | |

Automatic Flush Valves

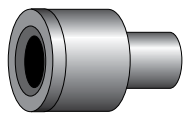

| Part No. | Description | Color | Bag Qty./ Box Qty. | Wt. per 100 (lbs.) | Product Class |
|----------|--|-------|-----------------------|-----------------------|------------------|
| FVA 600 | Automatic Flush Valve – Closes at 7 PSI (Fits .610" to .630" OD Tubing i.e. A 620) | Green | 25/500 | 1.5 | 21DI |
| FVA 700 | Automatic Flush Valve – Closes at 7 PSI (Fits .680" to .704" OD Tubing i.e. A 700) | Black | 25/500 | 1.4 | 21DI |
| FVA 710 | Automatic Flush Valve – Closes at 7 PSI (Fits .704" to .710" OD Tubing i.e. A 710) | Blue | 25/500 | 1.4 | 21DI |

Figure 8 End Enclosures



| Part No. | Description | Color | Bag Qty./ Box Qty. | Wt. per 100 (lbs.) | Product Class |
|---------------------------------|--|-------|-----------------------|-----------------------|------------------|
| F 870 | Figure "8" End Plug (Fits .620" OD to .710" OD Tubing) | Black | 100/3,000 | 0.7 | 21DI |
| Fits A 620, A 700, A 710 Tubing | | | | | |
| F 890 | Figure "8" End Plug (Fits .830" OD to .940" OD Tubing) | Black | 100/1,500 | 1.5 | 21DI |
| Fits A 940 Tubing | | | | | |
| TEC | Thin Walled Tape End Closure | Black | 100/2,000 | 1.6 | 21DI |

FITTINGS & ACCESSORIES

Sod Staples

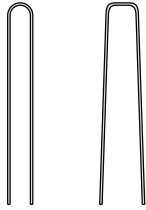

| Part No. | Description | Color | Bag Qty./ Box Qty. | Wt. per 100 (lbs.) | Product Class |
|----------|-------------------------|-------|--------------------|--------------------|---------------|
| FW6 | 6" Sod Staple Flat Top | N/A | N/A/1,000 | 3.5 | 21DT |
| FW6/100 | 6" Sod Staple Flat Top | N/A | 100/N/A | 3.5 | 21DT |
| FW6/25 | 6" Sod Staple Flat Top | N/A | 25/N/A | 3.5 | 21DT |
| SW6 | 6" Sod Staple Round Top | N/A | N/A/1,000 | 3.4 | 21DT |
| SW6/100 | 6" Sod Staple Round Top | N/A | 100/N/A | 3.4 | 21DT |
| SW6/25 | 6" Sod Staple Round Top | N/A | 25/N/A | 3.4 | 21DT |

Stakes

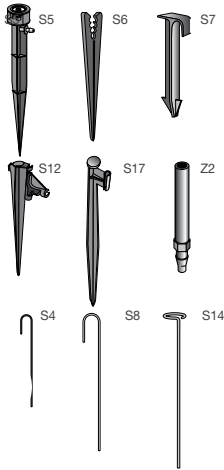

| Part No. | Description | Color | Bag Qty./ Box Qty. | Wt. per 100 (lbs.) | Product Class |
|----------|--|--------|--------------------|--------------------|---------------|
| S 5 | 5" Plastic Elbow Stake with 1/4" Barbed Side Inlet and 10/32 NPT Outlet | Black | 100/1,500 | 1.4 | 21DI |
| S 6 | 6" Plastic Stake (Fits A 185, A 220 and A 250 Tubing) | Black | 100/3,000 | 1.0 | 21DI |
| S 7 | 6" Plastic Stake to Hold Down .620" to .710" OD Tubing | Black | 50/700 | 2.9 | 21DI |
| S 12 | 12" Plastic Stake to Hold A 250/V 250 Tubing | Black | 100/300 | 6.2 | 21DI |
| S 17 | 17" Plastic Stake to Support .160" ID x .300" OD Rigid Risers | Black | 250/250 | 9.4 | 21DI |
| Z 2 | Snap-in Adapter for S 17 Stake 10-32 Self Tap x 1/4" Barb | Black | 100/1,000 | 0.5 | 21DI |
| S 4 | 5" 14-Gauge Galvanized Wire Stake | Silver | 100/2,500 | 1.2 | 21DI |
| S 8 | 8" 12-Gaug Galvanized Wire Stake | Silver | 100/2,000 | 0.5 | 21DI |
| S 14 | 14" 11-Gauge Galvanized Wire Stabilizer Stake for Rigid Riser Jet Assemblies | Silver | 50/1,000 | 5.0 | 21DI |

Valves

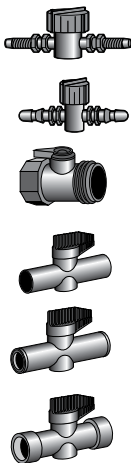

| Part No. | Description | Color | Bag Qty./ Box Qty. | Wt. per 100 (lbs.) | Product Class |
|--|---|-------|--------------------|--------------------|---------------|
| MV 25 | 1/4" Flow Controlling Valve (Barb x Barb) (Fits .160" to .170" ID Tubing i.e. A 250) | Black | 100/500 | 0.4 | 21DI |
| MVT 25 | 1/4" Flow Controlling Valve (Thread x Thread) (Fits .160" ID to .300" OD Risers; Use with A 250 Tubing) | Black | 100/500 | 0.4 | 21DI |
| BV 75 | 3/4" FHT x 3/4" MHT Ball Valve | Black | 25/150 | 3.8 | 21DI |
| FC 500 | 1/2" Flow Controlling Valve (Fits .455" to .480" OD Tubing i.e. A 455) | Red | 25/200 | 5.8 | 21DI |
| FC 600 | 1/2" Flow Controlling Valve (Fits .610" to .630" OD Tubing i.e. A 620) | Green | 25/200 | 5.6 | 21DI |
| FC 700 | 1/2" Flow Controlling Valve (Fits .680" to .704" OD Tubing i.e. A 700) | Black | 25/200 | 5.4 | 21DI |
| FC 710 | 1/2" Flow Controlling Valve (Fits .704" to .710" OD Tubing i.e. A 710) | Blue | 25/200 | 5.4 | 21DI |
| Note: Not to be used as a shutoff valve. | | | | | |
| FC 800 | 3/4" Flow Controlling Valve (Fits .830" OD Tubing) | Black | 25/125 | 7.6 | 21DI |
| FC 900 | 3/4" Flow Controlling Valve (Fits .940" OD Tubing i.e. A 940) | Grey | 25/125 | 7.5 | 21DI |

FITTINGS & ACCESSORIES

Air/Vacuum Valves

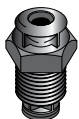

| Part No. | Description | Color | Bag Qty./ Box Qty. | Wt. per 100 (lbs.) | Product Class |
|----------|---|-------|-----------------------|-----------------------|------------------|
| AVRV 50 | 1/2" Air/Vacuum release valve (1/2" MIPT inlet) | Black | 25/100 | 1.6 | 21DI |

Hole Punches

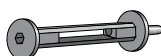

| Part No. | Description | Color | Bag Qty./ Box Qty. | Wt. per 100 (lbs.) | Product Class |
|-----------|---|--------|-----------------------|-----------------------|------------------|
| HP 100 | Hole Punch for 1/8" Fittings. Insert Tool for BT 250, TT 250 Fittings | Blue | 10/150 | 3.8 | 21DI |
| HP 125 | Hole Punch for PC Plus™, Multi-Flo™, Aqua-Flo™, Dial-a-Flo™, Super-Flo™, Misti-Flo™ and 1/4" Fittings. Insert Tool for BT 250, TT 250 Fittings. | Green | 10/150 | 3.8 | 21DI |
| HP 125PRO | Hole Punch for for 1/4" fittings, insert tool for PCP Drippers | Green | 1/10 | 17.4 | 21DI |
| HP 240 | Hole Punch for Mono-Flo™ Emitters | Blue | 10/50 | 4.1 | 21DI |
| PPT | Punch Pal™ Tool (Plastic Hole Punch Including Socket for Inerting Jets) | Orange | 50/500 | 0.7 | 21DI |



Emitter Access Boxes



| Part No. | Description | Color | Bag Qty./ Box Qty. | Wt. per 100 (lbs.) | Product Class |
|----------|--|--------|-----------------------|-----------------------|------------------|
| EB 6 | 6" Emitter/Bubbler Access Box | Black | 24/24 | 57.7 | 21DI |
| EBDS 6 | 6" Emitter/Bubbler Access Box for Desert Landscaping | Tan | 24/24 | 57.7 | 21DI |
| EBRC 6 | 6" Emitter/Bubbler Access Box for Reclaimed Water | Purple | N/A/24 | 57.7 | 21DI |

Tubing Accessories and Miscellaneous

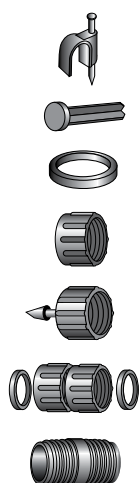

| Part No. | Description | Color | Bag Qty./ Box Qty. | Wt. per 100 (lbs.) | Product Class |
|----------|---|-------|-----------------------|-----------------------|------------------|
| MC 250 | 1/4" Mounting Clamp (Fits A 220 and A 250 Tubing) | Black | 100/4,000 | 0.2 | 21DI |
| MC 500 | 3/8" Mounting Clamp (Fits A 455 Tubing) | Black | 100/1,500 | 0.4 | 21DI |
| MC 710 | 1/2" Mounting Clamp (Fits A 620 and A 700 Tubing) | Black | 100/1,000 | 0.6 | 21DI |
| BP 250 | Bug Plug for A 220 and A 250 | Black | 100/5,000 | 0.1 | 21DI |
| W 75 | 3/4" Vinyl Washer | Black | 100/3,000 | 0.2 | 21DI |
| CAP 75 | 3/4" FHT Cap with Washer | Black | 100/1,500 | 1.8 | 21DI |
| SAH | Adapter with Washer (3/4" FHT x 1/4" Barb) | Black | 100/500 | 1.7 | 21DI |
| PHA 75 | 3/4" FHT Swivel x 3/4" FPT Swivel Adapter | Black | 25/300 | 4.2 | 21DI |
| TNPH | 3/4" Transition Nipple (3/4" MHT x 3/4" MPT) | Black | 100/500 | 2.8 | 21DI |

DISTRIBUTION TUBING

Distribution & Supply Tubing

50 ft. & 100 ft. Coils in Shrink Wrapped Packaging



Self Coil

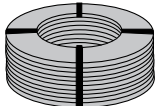

Plastic Hub (1") w/Chipboard Flanges

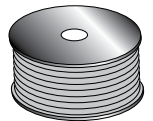

Sunburst Cardboard Spool



Self Coil

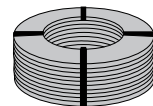

Sunburst cardboard spool

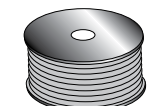

Plastic hub (1") with chipboard flanges



Bucket

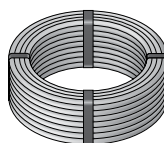

Supply Tubing

| Part No. | Description | Color | Coil Size/Type | Wt. per 100' (lbs.) | Product Class |
|--------------|--|---------|------------------------|---------------------|---------------|
| A 185 | 1/8" Polyethylene Tubing (0.125" ID x 0.185" OD) | Black | 2,000'/Spool | 0.6 | 21DT |
| A 185/500 | 1/8" Polyethylene Tubing (0.125" ID x 0.185" OD) | Black | 500'/Spool | 0.6 | 21DT |
| A 185/1000 | 1/8" Polyethylene Tubing (0.125" ID x 0.185" OD) | Black | 1,000'/Spool | 0.6 | 21DT |
| A 185V | 1/8" Vinyl Tubing (0.125" ID x 0.185" OD) | Black | 2,000'/Spool | 1.0 | 21DT |
| A 185V/100 | 1/8" Vinyl Tubing (0.125" ID x 0.185" OD) | Black | 100'/Coil | 1.0 | 21DT |
| A 185V/1000 | 1/8" Vinyl Tubing (0.125" ID x 0.185" OD) | Black | 1,000'/Spool | 1.0 | 21DT |
| A 220 | 1/4" Polyethylene Tubing (0.160" ID x 0.220" OD) | Black | 1,500'/Spool | 0.7 | 21DT |
| A 220/100 | 1/4" Polyethylene Tubing (0.160" ID x 0.220" OD) | Black | 100'/Coil | 0.7 | 21DT |
| A 220/500 | 1/4" Polyethylene Tubing (0.160" ID x 0.220" OD) | Black | 500'/Spool | 0.7 | 21DT |
| A 220/1000 | 1/4" Polyethylene Tubing (0.160" ID x 0.220" OD) | Black | 1,000'/Spool | 0.7 | 21DT |
| A 220/2500 | 1/4" Polyethylene Tubing (0.160" ID x 0.220" OD) | Black | 2,500'/Spool | 0.7 | 21DT |
| A 220V | 1/4" Vinyl Tubing (0.160" ID x 0.220" OD) | Black | 1,500'/Spool | 1.2 | 21DT |
| A 220V/100 | 1/4" Vinyl Tubing (0.160" ID x 0.220" OD) | Black | 100'/Coil | 1.2 | 21DT |
| A 220V/500 | 1/4" Vinyl Tubing (0.160" ID x 0.220" OD) | Black | 500'/Spool | 1.2 | 21DT |
| A 220V/1000 | 1/4" Vinyl Tubing (0.160" ID x 0.220" OD) | Black | 1,000'/Spool | 1.2 | 21DT |
| A 220V/2500 | 1/4" Vinyl Tubing (0.160" ID x 0.220" OD) | Black | 2,500'/Spool | 1.2 | 21DT |
| A 250 | 1/4" Polyethylene Tubing (0.170" ID x 0.250" OD) | Black | 1,250'/Spool | 1.1 | 21DT |
| A 250/50 | 1/4" Polyethylene Tubing (0.170" ID x 0.250" OD) | Black | 50'/Coil | 1.1 | 21DT |
| A 250BR/50 | 1/4" Polyethylene Tubing (0.170" ID x 0.250" OD) | Brown | 50'/Coil | 1.1 | 21DT |
| A 250GR/50 | 1/4" Polyethylene Tubing (0.170" ID x 0.250" OD) | Green | 50'/Coil | 1.1 | 21DT |
| A 250RD/50 | 1/4" Polyethylene Tubing (0.170" ID x 0.250" OD) | Redwood | 50'/Coil | 1.1 | 21DT |
| A 250SD/50 | 1/4" Polyethylene Tubing (0.170" ID x 0.250" OD) | Sand | 50'/Coil | 1.1 | 21DT |
| A 250WT/50 | 1/4" Polyethylene Tubing (0.170" ID x 0.250" OD) | White | 50'/Coil | 1.1 | 21DT |
| A 250/100 | 1/4" Polyethylene Tubing (0.170" ID x 0.250" OD) | Black | 100'/Coil | 1.1 | 21DT |
| A 250BR/100 | 1/4" Polyethylene Tubing (0.170" ID x 0.250" OD) | Brown | 100'/Coil | 1.1 | 21DT |
| A 250/500 | 1/4" Polyethylene Tubing (0.170" ID x 0.250" OD) | Black | 500'/Spool | 1.1 | 21DT |
| A 250/1000 | 1/4" Polyethylene Tubing (0.170" ID x 0.250" OD) | Black | 1,000'/Spool | 1.1 | 21DT |
| A 250/1000B | 1/4" Polyethylene Tubing (0.170" ID x 0.250" OD) in Bucket | Black | 1,000'/Spool in Bucket | 1.1 | 21DT |
| A 250/2500 | 1/4" Polyethylene Tubing (0.170" ID x 0.250" OD) | Black | 2,500'/Spool | 1.1 | 21DT |
| A 250V | 1/4" Vinyl Tubing (0.170" ID x 0.250" OD) | Black | 1,250'/Spool | 1.6 | 21DT |
| A 250V/50 | 1/4" Vinyl Tubing (0.170" ID x 0.250" OD) | Black | 50'/Coil | 1.6 | 21DT |
| A 250V/100 | 1/4" Vinyl Tubing (0.170" ID x 0.250" OD) | Black | 100'/Coil | 1.6 | 21DT |
| A 250V/500 | 1/4" Vinyl Tubing (0.170" ID x 0.250" OD) | Black | 500'/Spool | 1.6 | 21DT |
| A 250V/1000 | 1/4" Vinyl Tubing (0.170" ID x 0.250" OD) | Black | 1,000'/Spool | 1.6 | 21DT |
| A 250V/1000B | 1/4" Vinyl Tubing (0.170" ID x 0.250" OD) in Bucket | Black | 1,000'/Spool in Bucket | 1.6 | 21DT |
| A 455/100 | 3/8" Polyethylene Tubing (0.375" ID x 0.455" OD) | Black | 100'/Coil | 2.2 | 21DT |
| A 455/500 | 3/8" Polyethylene Tubing (0.375" ID x 0.455" OD) | Black | 500'/Coil | 2.2 | 21DT |

DISTRIBUTION TUBING

Distribution & Supply Tubing

All 17mm Coils in Shrink Wrapped Packaging



PROFESSIONAL IRRIGATION



Self Coil

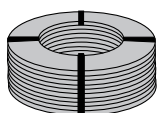

Plastic Hub (1")
w/Chipboard Flanges

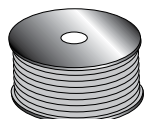

Sunburst
Cardboard Spool



Self Coil

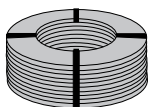

Sunburst Cardboard Spool

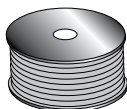

Plastic Hub (1")
w/ Chipboard Flanges

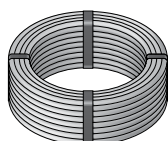

Supply Tubing

| Part No. | Description | Color | Coil Size/Type | Wt. per 100' (lbs.) | Product Class |
|--------------|--|-------------------------|-------------------|---------------------|---------------|
| A 620 | 1/2" Polyethylene Tubing (0.520" ID x 0.620" OD) | Black | 1,000'/Coil | 3.6 | 21DT |
| A 620/100 | 1/2" Polyethylene Tubing (0.520" ID x 0.620" OD) | Black | 100'/Coil | 3.6 | 21DT |
| A 620BR/100 | 1/2" Polyethylene Tubing (0.520" ID x 0.620" OD) | Brown | 100'/Coil | 3.6 | 21DT |
| A 620/500 | 1/2" Polyethylene Tubing (0.520" ID x 0.620" OD) | Black | 500'/Coil | 3.6 | 21DT |
| A 620BR/500 | 1/2" Polyethylene Tubing (0.520" ID x 0.620" OD) | Brown | 500'/Coil | 3.6 | 21DT |
| A 660BR/100S | 17mm Polyethylene Tubing (0.560" ID x 0.660" OD) | Brown | 100'/Wrapped Coil | 3.8 | 21DT |
| A 660BR/250S | 17mm Polyethylene Tubing (0.560" ID x 0.660" OD) | Brown | 250'/Wrapped Coil | 3.8 | 21DT |
| A 660BR/500S | 17mm Polyethylene Tubing (0.560" ID x 0.660" OD) | Brown | 500'/Wrapped Coil | 3.8 | 21DT |
| A 700 | 1/2" Polyethylene Tubing (0.600" ID x 0.700" OD) | Black | 500'/Coil | 4.1 | 21DT |
| A 700SH | 1/2" Polyethylene Tubing (0.600" ID x 0.700" OD) | Black | 500'/Wrapped Coil | 4.1 | 21DT |
| A 700BR | 1/2" Polyethylene Tubing (0.600" ID x 0.700" OD) | Brown | 500'/Coil | 4.1 | 21DT |
| A 700/50 | 1/2" Polyethylene Tubing (0.600" ID x 0.700" OD) | Black | 50'/Coil | 4.1 | 21DT |
| A 700/100 | 1/2" Polyethylene Tubing (0.600" ID x 0.700" OD) | Black | 100'/Coil | 4.1 | 21DT |
| A 700/100SH | 1/2" Polyethylene Tubing (0.600" ID x 0.700" OD) | Black | 100'/Wrapped Coil | 4.1 | 21DT |
| A 700BR/100 | 1/2" Polyethylene Tubing (0.600" ID x 0.700" OD) | Brown | 100'/Coil | 4.1 | 21DT |
| A 700/1000 | 1/2" Polyethylene Tubing (0.600" ID x 0.700" OD) | Black | 1,000'/Coil | 4.1 | 21DT |
| A 710 | 1/2" Polyethylene Tubing (0.620" ID x 0.710" OD) | Black | 500'/Coil | 3.8 | 21DT |
| A 710GRS | 1/2" Polyethylene Tubing (0.620" ID x 0.710" OD) | Black/ Green Stripe | 500'/Coil | 3.8 | 21DT |
| A 710PS | 1/2" Polyethylene Tubing (0.620" ID x 0.710" OD) | Black/ Purple Stripe | 500'/Coil | 3.8 | 21DT |
| A 710RDS | 1/2" Polyethylene Tubing (0.620" ID x 0.710" OD) | Black/ Red Stripe | 500'/Coil | 3.8 | 21DT |
| A 710WHS | 1/2" Polyethylene Tubing (0.620" ID x 0.710" OD) | Black/ White Stripe | 500'/Coil | 3.8 | 21DT |
| A 710YS | 1/2" Polyethylene Tubing (0.620" ID x 0.710" OD) | Black/ Yellow Stripe | 500'/Coil | 3.8 | 21DT |
| A 710SH | 1/2" Polyethylene Tubing (0.620" ID x 0.710" OD) | Black | 500'/Wrapped Coil | 3.8 | 21DT |
| A 710/50 | 1/2" Polyethylene Tubing (0.620" ID x 0.710" OD) | Black | 50'/Coil | 3.8 | 21DT |
| A 710/100 | 1/2" Polyethylene Tubing (0.620" ID x 0.710" OD) | Black | 100'/Coil | 3.8 | 21DT |
| A 710/100RDS | 1/2" Polyethylene Tubing (0.620" ID x 0.710" OD) | Black/ Red Stripe | 100'/Coil | 3.8 | 21DT |
| A 710/100SH | 1/2" Polyethylene Tubing (0.620" ID x 0.710" OD) | Black | 100'/Wrapped Coil | 3.8 | 21DT |
| A 710/1000 | 1/2" Polyethylene Tubing (0.620" ID x 0.710" OD) | Black | 1,000'/Coil | 3.8 | 21DT |
| A 940 | 3/4" Polyethylene Tubing (0.830" ID x 0.940" OD) | Black | 500'/Coil | 6.4 | 21DT |
| A 940RDS | 3/4" Polyethylene Tubing (0.830" ID x 0.940" OD) | Black/ Red Stripe | 500'/Coil | 6.4 | 21DT |
| A 940WHS | 3/4" Polyethylene Tubing (0.830" ID x 0.940" OD) | Black/ White Stripe | 500'/Coil | 6.4 | 21DT |
| A 940YS | 3/4" Polyethylene Tubing (0.830" ID x 0.940" OD) | Black/ Yellow Stripe | 500'/Coil | 6.4 | 21DT |
| A 940PS | 3/4" Polyethylene Tubing (0.830" ID x 0.940" OD) | Purple Stripe | N/A | N/A | 21DT |
| A 940GRS | 3/4" Polyethylene Tubing (0.830" ID x 0.940" OD) | Green Stripe | 500'/Coil | 6.4 | 21DT |
| A 940/100 | 3/4" Polyethylene Tubing (0.830" ID x 0.940" OD) | Black | 100'/Coil | 6.4 | 21DT |
| A 940/1000 | 3/4" Polyethylene Tubing (0.830" ID x 0.940" OD) | Black | 1,000'/Coil | 6.4 | 21DT |
| A 1200 | 1" Polyethylene Tubing (1.060" ID x 1.200" OD) | Black | 500'/Coil | 9.8 | 21DT |

DISTRIBUTION TUBING

IPS Flex Pipe

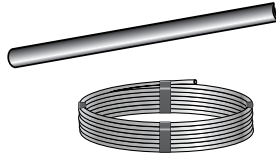

| Part No. | Description | Color | Bag Qty./ Box Qty. | Wt. per 100' (lbs.) | Product Class |
|------------|--|-------|-----------------------|------------------------|------------------|
| IPS 75/3 | 36" Cut, 3/4" IPS Flex Vinyl Pipe (0.742" ID x 1.050" OD, 0.154" Wall) | Black | 25/Bundle | 84.0 | 21DT |
| IPS 75/4 | 48" Cut, 3/4" IPS Flex Vinyl Pipe (0.742" ID x 1.050" OD, 0.154" Wall) | Black | 25/Bundle | 112.0 | 21DT |
| IPS 50/100 | 1/2" IPS Flex Vinyl Pipe (0.546" ID x 0.840" OD, 0.147" Wall) | Black | 100' | 20.5 | 21DT |
| IPS 75/100 | 3/4" IPS Flex Vinyl Pipe (0.742" ID x 1.050" OD, 0.154" Wall) | Black | 100' | 28.5 | 21DT |

Swing Pipe

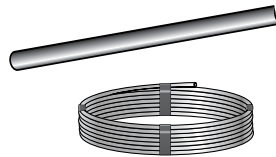

| Part No. | Description | Color | Bag Qty./ Box Qty. | Wt. per 100' (lbs.) | Product Class |
|----------------|--|-------|-----------------------|------------------------|------------------|
| SRP/100SH | 1/2" Flexee™ Swing Riser Pipe (0.490" ID x 0.690" OD), Shrinkwrapped | Black | 100'/1,000' | 7.7 | 21DT |
| SRP FLEX/100SH | 1/2" Super Flexee™ Swing Riser Pipe (0.490" ID x 0.690" OD), Shrinkwrapped | Black | 100'/1,000' | 7.7 | 21DT |

TUBING FRACTIONAL LOSSES

Polyethylene Supply Tubing – Friction Loss (PSI/100 Feet)

| Flow | Part Number | | | | |
|----------|-------------|-------|-------|-------|-------|
| | A455 | A620 | A700 | A710 | A940 |
| 0.5 gpm | 1.80 | 0.37 | 0.19 | 0.16 | 0.05 |
| 1.0 gpm | 6.6 | 1.33 | 0.68 | 0.55 | 0.15 |
| 1.5 gpm | 12.2 | 2.45 | 1.24 | 1.01 | 0.32 |
| 2.0 gpm | | 4.80 | 2.17 | 1.78 | 0.53 |
| 2.5 gpm | | 6.18 | 3.13 | 2.56 | 0.82 |
| 3.0 gpm | | 10.31 | 5.16 | 4.23 | 1.11 |
| 3.5 gpm | | | 6.85 | 5.62 | 1.52 |
| 4.0 gpm | | | 8.78 | 7.20 | 1.90 |
| 4.5 gpm | | | 10.32 | 8.46 | 2.42 |
| 5.0 gpm | | | | 10.10 | 2.88 |
| 6.0 gpm | | | | | 4.03 |
| 7.0 gpm | | | | | 5.37 |
| 8.0 gpm | | | | | 6.87 |
| 9.0 gpm | | | | | 8.53 |
| 10.0 gpm | | | | | 10.37 |

IPS Flex PVC Hose – Friction Loss (PSI/100 Feet)

| Flow | Part Number | |
|----------|-------------|--------|
| | IPS 50 | IPS 75 |
| 0.5 gpm | 0.31 | 0.07 |
| 1.0 gpm | 1.10 | 0.23 |
| 1.5 gpm | 2.09 | 0.45 |
| 2.0 gpm | 3.85 | 0.75 |
| 2.5 gpm | 5.10 | 1.15 |
| 3.0 gpm | 8.52 | 1.55 |
| 3.5 gpm | 11.34 | 2.14 |
| 4.0 gpm | 13.86 | 2.66 |
| 5.0 gpm | | 3.92 |
| 6.0 gpm | | 5.65 |
| 7.0 gpm | | 7.51 |
| 8.0 gpm | | 9.62 |
| 9.0 gpm | | 11.95 |
| 10.0 gpm | | 14.52 |

Polyethylene/Vinyl Micro-Tubing – Friction Loss (PSI/100 Feet)

| Flow | Part Number | | |
|--------|-------------|---------|---------|
| | A 185/V | A 220/V | A 250/V |
| 3 gph | 5.9 | 1.7 | 1.3 |
| 6 gph | 19.7 | 5.8 | 4.3 |
| 9 gph | 41.5 | 12.2 | 9.1 |
| 12 gph | | 20.9 | 15.6 |
| 15 gph | | 31.7 | 23.9 |
| 18 gph | | 43.9 | 33.0 |
| 21 gph | | | 44.3 |

“Flexee” Swing Riser Pipe – Friction Loss (PSI/100 Feet)

| Flow | Part Number |
|---------|-------------|
| | SRP 100 |
| 0.5 gpm | 0.40 |
| 1.0 gpm | 1.47 |
| 1.5 gpm | 2.70 |
| 2.0 gpm | 5.28 |
| 2.5 gpm | 6.80 |
| 3.0 gpm | 11.35 |

TECHNICAL INFORMATION – CONVERSION FACTORS

| To Convert From | To | Multiply by |
|-------------------------|-------------------------|-------------|
| AREA | | |
| Acres | Sq. Feet | 43,560 |
| Acres | Sq. Meters | 4,046.8 |
| Sq. Centimeters | Sq. Feet | 0.00108 |
| Sq. Centimeters | Sq. Inches | 0.1550 |
| Sq. Feet | Sq. Centimeters | 929.03 |
| Sq. Feet | Sq. Inches | 144 |
| Sq. Feet | Sq. Meters | 0.0929 |
| Sq. Feet | Sq. Yards | 0.1111 |
| Sq. Inches | Sq. Centimeters | 6.4516 |
| Sq. Inches | Sq. Feet | 0.00694 |
| Sq. Inches | Sq. Meters | 0.000645 |
| Sq. Meters | Sq. Feet | 10.764 |
| Sq. Meters | Sq. Yards | 1.196 |
| Sq. Yards | Sq. Feet | 9 |
| Sq. Yards | Sq. Meters | 0.8361 |
| ENERGY AND POWER | | |
| Foot Pounds | BTU | 0.001285 |
| Foot Pounds | Joules | 1.3558 |
| Foot Pounds | Kilogram-Meters | 0.13826 |
| Foot Pound per Minute | Horsepower | 0.0000303 |
| Horsepower | BTU per Minute | 42.41 |
| Horsepower | Foot Pound per Minute | 33,000 |
| Horsepower | Foot Pound per Second | 550 |
| Horsepower | Kilowatts | 0.7457 |
| FLOW | | |
| Cubic Feet per Minute | Cubic Meters per Second | 0.0004719 |
| Cubic Feet per Second | Cubic Meters per Second | 0.02832 |
| Cubic Yards/Minute | Cubic Meters per Second | 0.01274 |
| Gallons/Minute | Cubic Meters per Second | 0.0000631 |
| Gallons/Minute | Cubic Meters per Hour | 0.22716 |
| LENGTH | | |
| Centimeters | Inches | 0.3937 |
| Centimeters | Yards | 0.01094 |
| Feet | Inches | 12 |
| Feet | Meters | 0.30481 |
| Feet | Yards | 0.333 |
| Inches | Centimeters | 2.540 |
| Inches | Feet | 0.08333 |
| Inches | Meters | 0.02540 |
| Inches | Microns | 25.400 |
| Inches | Millimeters | 25.400 |
| Inches | Yards | 0.2778 |
| Kilometers | Feet | 3.281 |
| Kilometers | Miles (Nautical) | 0.5336 |
| Kilometers | Miles (Statue) | 0.6214 |
| Kilometers | Yards | 1.094 |
| Meters | Feet | 3.2809 |
| Meters | Yards | 1.0936 |
| Miles (Statue) | Feet | 5.280 |
| Miles | Kilometers | 1.6093 |
| Miles (Statue) | Meters | 1,609.34 |
| Miles (Statue) | Yards | 1,760 |
| Miles (Nautical) | Kilometers | 1,852 |
| Miles (Nautical) | Meters | 1.8520 |
| Millimeters | Inches | 0.03937 |
| Rods | Meters | 5.0292 |
| Yards | Centimeters | 0.9144 |
| Yards | Feet | 3 |
| Yards | Inches | 36 |
| Yards | Meters | 0.9144 |

| To Convert From | To | Multiply by |
|-----------------------|-----------------------|-------------|
| PRESSURE | | |
| Kilograms/Sq. Cm. | Pounds per Sq. Inch | 14,223 |
| Kilograms/Sq. Meter | Pounds per Sq. Foot | 0.2048 |
| Kilograms/Cubic Meter | Pounds per Cubic Foot | 0.0624 |
| Pounds per Cubic Foot | Kilograms/Cubic Meter | 16,019 |
| Pounds per Sq. Foot | Kilograms/Sq. Meter | 4.8824 |
| Pounds per Sq. Inch | Kilograms/Sq. Cm. | 0.0703 |
| VELOCITY | | |
| Feet/Minute | Meters per Second | 0.00508 |
| Feet/Second | Meters per Second | 0.3048 |
| Inches/Second | Meters per Second | 0.0254 |
| VOLUME | | |
| Cubic Centimeters | Cubic Inches | 0.06102 |
| Cubic Feet | Cubic Inches | 1,728 |
| Cubic Feet | Cubic Meters | 0.0283 |
| Cubic Feet | Cubic Yards | 0.0370 |
| Cubic Feet | Gallons | 7.481 |
| Cubic Feet | Liters | 28.32 |
| Cubic Feet | Quarts | 29.9222 |
| Cubic Inches | Cubic Centimeters | 16.39 |
| Cubic Inches | Cubic Feet | 0.0005787 |
| Cubic Inches | Cubic Meters | 0.00001639 |
| Cubic Inches | Liters | 0.0164 |
| Cubic Inches | Gallons | 0.004329 |
| Cubic Inches | Quarts | 0.01732 |
| Cubic Meters | Cubic Feet | 35.31 |
| Cubic Meters | Cubic Inches | 61,023 |
| Cubic Meters | Cubic Yards | 1.3087 |
| Cubic Yards | Cubic Feet | 27 |
| Cubic Yards | Cubic Meters | 0.7641 |
| Gallons | Cubic Feet | 0.1337 |
| Gallons | Cubic Inches | 231 |
| Gallons | Cubic Meters | 0.003785 |
| Gallons | Liters | 3.785 |
| Gallons | Quarts | 4 |
| Liters | Cubic Feet | 0.03531 |
| Liters | Cubic Inches | 61.017 |
| Liters | Gallons | 0.2642 |
| Liters | Pints | 2.1133 |
| Liters | Quarts | 1.057 |
| Liters | Cubic Meters | 0.0010 |

PROFESSIONAL IRRIGATION PRODUCTS INDEX

| Part No. | Page | Part No. | Page | Part No. | Page | Part No. | Page | Part No. | Page |
|--------------|------|--------------|------|---------------|------|-------------------|----------|-------------|------|
| A 185 | 135 | A 710SH | 136 | CMAH 710 | 129 | DAFT BUB | 117 | LCA 710 | 128 |
| A 185/500 | 135 | A 710WHS | 136 | CMAH 800 | 129 | DAFT FAN | 117 | MC 250 | 134 |
| A 185/1000 | 135 | A 710YS | 136 | CMAH 900 | 129 | DAFU 180 | 118 | MC 500 | 134 |
| A 185V | 135 | A 940 | 136 | CMAP 5-18 | 126 | DAFU 360 | 118 | MC 710 | 134 |
| A 185V/100 | 135 | A 940/100 | 136 | CMAP5-600 | 129 | DAFU BUB | 118 | MCO-0500 | 107 |
| A 185V/1000 | 135 | A 940/1000 | 136 | CMAP5-700 | 129 | DAFU FAN | 118 | MCO-0500-12 | 107 |
| A 220 | 135 | A 940GRS | 136 | CMAP5-710 | 129 | DBC 250 | 131 | MCO-0750 | 107 |
| A 220/100 | 135 | A 940PS | 136 | CMAP 6 | 120 | DFHD-BL-05-116-05 | 113 | MCO-0750-R | 107 |
| A 220/500 | 135 | A 940RDS | 136 | CMAP 12 | 120 | DFHD-BL-10-114-05 | 113 | MFA | 119 |
| A 220/1000 | 135 | A 940WHS | 136 | CMAP 75-18 | 126 | dzk 700/710 | 103 | MFBL 2 | 121 |
| A 220/2500 | 135 | A 940YS | 136 | CMAP 600 | 129 | EB 6 | 134 | MFBL 6 | 121 |
| A 220V | 135 | A 1200 | 136 | CMAP 700 | 129 | EBDS 6 | 134 | MFBL 10 | 121 |
| A 220V/100 | 135 | AFPC 5 | 117 | CMAP 710 | 129 | EBRC 6 | 134 | MFBL 20 | 121 |
| A 220V/500 | 135 | AFPC 5/25 | 117 | CMAP 800 | 129 | EL 17 | 127 | MV 25 | 133 |
| A 220V/1000 | 135 | AFPC 5/1000 | 117 | CMAP 900 | 129 | EL 250 | 131 | MVT 25 | 133 |
| A 220V/2500 | 135 | AFPC 10 | 117 | CRE-0500-3 | 107 | ELI | 122 | OP 250 | 122 |
| A 250 | 135 | AFPC 10/25 | 117 | CRE-0750-4 | 107 | F 870 | 132 | OR 027 | 104 |
| A 250/50 | 135 | AFPC 20 | 117 | CSA 18 | 126 | F 890 | 132 | OR 136 | 104 |
| A 250/100 | 135 | AFPC 20/25 | 117 | CSA 600 | 130 | FC 500 | 133 | PC 250 | 122 |
| A 250/500 | 135 | AFPC 50 | 117 | CSA 700 | 130 | FC 600 | 133 | PHA 75 | 134 |
| A 250/1000 | 135 | AFPC 50/25 | 117 | CSA 710 | 130 | FC 700 | 133 | PPT | 134 |
| A 250/1000B | 135 | AFPC 50/1000 | 117 | CSA 800 | 130 | FC 710 | 133 | PR 20 | 104 |
| A 250/2500 | 135 | AVRV 50 | 134 | CSA 900 | 130 | FC 800 | 133 | PR 30 | 104 |
| A 250BR/50 | 135 | BP 250 | 134 | CSAW 600 | 130 | FC 900 | 133 | PRH 20 | 105 |
| A 250BR/100 | 135 | BT 250 | 131 | CSAW 700 | 130 | FCO-0500 | 107 | PRH 30 | 105 |
| A 250GR/50 | 135 | BTMA 1750 | 127 | CSAW 710 | 130 | FCO-0750-R | 107 | PRH 40 | 105 |
| A 250RD/50 | 135 | BTMA 1775 | 127 | CSAW 800 | 130 | FPA-0500 | 105, 107 | PRM 30 | 104 |
| A 250SD/50 | 135 | BV 17 | 127 | CSAW 900 | 130 | FPA-0750 | 105, 107 | PRP 20 | 104 |
| A 250V | 135 | BV 75 | 133 | CSEL 700 | 130 | FPC-0490 | 105, 107 | PRP 30 | 104 |
| A 250V/50 | 135 | C 17 | 127 | CSEL 710 | 130 | FPE-0500 | 105, 107 | PRP 40 | 105 |
| A 250V/100 | 135 | C 125 | 131 | CSELW 600 | 130 | FPE-0500F | 107 | PRYF 30 | 103 |
| A 250V/500 | 135 | C 250 | 131 | CSELW 700 | 130 | FPE-0750 | 105, 107 | PRYF 40 | 103 |
| A 250V/1000 | 135 | CA 250 | 128 | CSELW 710 | 130 | FPT-0500 | 107 | PUPS | 119 |
| A 250V/1000B | 135 | CA 300 | 128 | CST 600 | 130 | FR2 17-710 | 103 | R 6 | 120 |
| A 250WT/50 | 135 | CA 500 | 128 | CST 710 | 130 | FR-0500-4 | 107 | R 8 | 120 |
| A 455/100 | 135 | CA 600 | 128 | CST 900 | 130 | FR-0500-4F | 107 | R 12 | 120 |
| A 455/500 | 135 | CA 700 | 128 | CSTW 600 | 130 | FR-0500-6 | 107 | R 18 | 120 |
| A 620 | 136 | CA 710 | 128 | CSTW 700 | 130 | FR-0500-6F | 107 | RA 250 | 131 |
| A 620/100 | 136 | CA 800 | 128 | CSTW 710 | 130 | FR-0750-6 | 107 | RABB 8 | 120 |
| A 620/500 | 136 | CA 900 | 128 | CSTW 900 | 130 | FR-1000-7 | 107 | RABB 12 | 120 |
| A 620BR/100 | 136 | CAP 75 | 134 | CT 18 | 126 | FVA 600 | 132 | RABB 18 | 120 |
| A 620BR/500 | 136 | CAP POP/5 | 103 | CT 600 | 128 | FVA 700 | 132 | RABT 6 | 120 |
| A 660BR/100S | 136 | CAP POP/25 | 103 | CT 700 | 128 | FVA 710 | 132 | RABT 8 | 120 |
| A 660BR/250S | 136 | CC 600 | 128 | CT 710 | 128 | FW6 | 133 | RABT 12 | 120 |
| A 660BR/500S | 136 | CC 700 | 128 | CT 800 | 128 | FW6/25 | 133 | RABT 18 | 120 |
| A 675CT | 103 | CC 710 | 128 | CT 900 | 128 | FW6/100 | 133 | RATT 6 | 120 |
| A 700 | 136 | CC 800 | 128 | CX 17 | 127 | GP 2 | 131 | RATT 8 | 120 |
| A 700/50 | 136 | CC 900 | 128 | CZK 100-30 | 103 | GP 2B | 131 | RATT 12 | 120 |
| A 700/100 | 136 | CEL 18 | 126 | CZK 100-30F | 103 | HP 100 | 134 | RATT 18 | 120 |
| A 700/100SH | 136 | CEL 600 | 128 | CZK 100-40 | 103 | HP 125 | 134 | RCC 6070 | 128 |
| A 700/1000 | 136 | CEL 700 | 128 | CZK 100-40F | 103 | HP 125PRO | 134 | RCC 6071 | 128 |
| A 700BR | 136 | CEL 710 | 128 | CZK 100-40VB1 | 103 | HP 240 | 134 | RCC 7071 | 128 |
| A 700BR/100 | 136 | CEL 800 | 128 | D 80 H | 122 | HPAM 4 | 121 | RCC 7090 | 128 |
| A 700SH | 136 | CEL 900 | 128 | DAFB 180 | 117 | HPAM 8 | 121 | RCC 8090 | 128 |
| A 710 | 136 | CEP 18 | 126 | DAFB 360 | 117 | HYP 250 | 119 | REA | 131 |
| A 710/50 | 136 | CFL 2 | 121 | DAFB BUB | 117 | HYP 500 | 119 | RS | 132 |
| A 710/100 | 136 | CFL 6 | 121 | DAFB FAN | 117 | HYPJ 250 | 119 | RSEL 600 | 132 |
| A 710/100RDS | 136 | CFL 10 | 121 | DAFS 135 | 117 | HYPJ 500 | 119 | RSEL 700 | 132 |
| A 710/100SH | 136 | CFL 20 | 121 | DAFS 180 | 117 | IPS 50/100 | 137 | RSEL 710 | 132 |
| A 710/1000 | 136 | CMAH | 129 | DAFS 360 | 117 | IPS 75/3 | 137 | RSELW 500 | 132 |
| A 710GRS | 136 | CMAH 18 | 126 | DAFS BUB | 117 | IPS 75/4 | 137 | RSELW 600 | 132 |
| A 710PS | 136 | CMAH 600 | 129 | DAFT 180 | 117 | IPS 75/100 | 137 | RSELW 700 | 132 |
| A 710RDS | 136 | CMAH 700 | 129 | DAFT 360 | 117 | LCA 700 | 128 | RSELW 710 | 132 |

FLOW MANAGEMENT





FLOW MANAGEMENT



NDS® Flow Management offers a range of engineered specialty fittings and valves. From expansion repair and compression couplings, to spring, swing check and ball valves, we offer a full line of products for irrigation, plumbing, pool and spa, and industrial applications.

COMPRESSION FITTINGS

IPS Couplings, Tees & Adapters *(Rated @ 150 PSI Static Pressure @ 72°F)*

| Part No. | Ref. No. | IPS Size UC Connection | IPS Branch | Body Length | Color | Pkg. Qty. | Case (lbs.) | Product Class | Specifications | |
|---|------------|---------------------------|------------|----------------|--------|-----------|----------------|------------------|----------------------------------|----------------------------------|
| Couplings — PVC | | | | | | | | | | |
| Couplings PVC  | CPC-0500 | 110-05 | 1/2" | 4-1/2" | White | 30 | 7.0 | 42CP | PVC NSF/ANSI 61+372 UPC | |
| | CPC-0750 | 110-07 | 3/4" | 5-1/4" | White | 24 | 8.2 | 42CP | | |
| | CPC-1000 | 110-10 | 1" | 5-3/4" | White | 18 | 8.2 | 42CP | | |
| | CPC-1250 | 110-12 | 1-1/4" | 6-1/4" | White | 12 | 7.6 | 42CP | | |
| | CPC-1500 | 110-15 | 1-1/2" | 6-3/4" | White | 15 | 12.25 | 42CP | | |
| | CPC-2000 | 110-20 | 2" | 7-1/8" | White | 12 | 14.2 | 42CP | | |
| | CPC-2500 | 110-25 | 2-1/2" | 9-5/8" | White | 5 | 12.25 | 42CP | | |
| | CPC-3000 | 110-30 | 3" | 10-7/8" | White | 4 | 13.2 | 42CP | | |
| | CPC-4000 | 110-40 | 4" | 12-1/8" | White | 3 | 13.9 | 42CP | | |
| | CPC-6000 | 110-60 | 6" | 11-3/8" | White | 1 | 8.6 | 42CP | | |
| Slip Tee | | | | | | | | | | |
| Slip Tee PVC  | CPT-0500-S | 121-05 | 1/2" | 1/2" S | 5" | White | 24 | 7.0 | 42CP | PVC NSF/ANSI 61+372 UPC |
| | CPT-0750-S | 121-07 | 3/4" | 3/4" S | 5-3/8" | White | 20 | 8.0 | 42CP | |
| | CPT-1000-S | 121-10 | 1" | 1" S | 5-5/8" | White | 12 | 7.0 | 42CP | |
| | CPT-1250-S | 121-12 | 1-1/4" | 1-1/4" S | 6-1/8" | White | 8 | 6.2 | 42CP | |
| | CPT-1500-S | 121-15 | 1-1/2" | 1-1/2" S | 6-3/4" | White | 6 | 6.4 | 42CP | |
| | CPT-2000-S | 121-20 | 2" | 2" S | 7-1/2" | White | 5 | 7.25 | 42CP | |
| Threaded Tee | | | | | | | | | | |
| Threaded Tee PVC  | CPT-0500-T | 120-05 | 1/2" | 1/2" FPT | 5" | White | 24 | 7.0 | 42CP | PVC NSF/ANSI 61+372 |
| | CPT-0750-T | 120-07 | 3/4" | 3/4" FPT | 5-3/8" | White | 20 | 8.0 | 42CP | |
| | CPT-1000-T | 120-10 | 1" | 1" FPT | 5-5/8" | White | 12 | 7.0 | 42CP | |
| | CPT-1250-T | 120-12 | 1-1/4" | 1-1/4" FPT | 6-1/8" | White | 8 | 6.2 | 42CP | |
| | CPT-1500-T | 120-15 | 1-1/2" | 1-1/2" FPT | 6-3/4" | White | 6 | 6.4 | 42CP | |
| Reducing Tee w/Threaded Outlet | | | | | | | | | | |
| Reducing Tee w/Threaded Outlet  | CRT-0750-T | 122-75 | 3/4" | 1/2" FPT | 5-3/8" | White | 20 | 8.0 | 42CP | PVC NSF/ANSI 61+372 |

Note: All dimensions are nominal.

COMPRESSION FITTINGS

IPS Couplings, Tees & Adapters *(Rated @ 150 PSI Static Pressure @ 72°F)*

PVC Male Adapter



| Part No. | Ref. No. | IPS Size UC Connection | IPS Size MPT Connection | Body Length | Color | Pkg. Qty. | Case (lbs.) | Product Class | Specifications |
|------------------|----------|------------------------|-------------------------|-------------|-------|-----------|-------------|---------------|-------------------------|
| PVC Male Adapter | | | | | | | | | |
| CPA-0500 | 130-05 | 1/2" | 1/2" MPT | 3-3/8" | White | 48 | 8.2 | 42CP | PVC NSF/ANSI 61+372 UPC |
| CPA-0750 | 130-07 | 3/4" | 3/4" MPT | 4" | White | 36 | 8.2 | 42CP | |
| CPA-1000 | 130-10 | 1" | 1" MPT | 4" | White | 24 | 7.0 | 42CP | |
| CPA-1250 | 130-12 | 1-1/4" | 1-1/4" MPT | 4-1/8" | White | 18 | 7.3 | 42CP | |
| CPA-1500 | 130-15 | 1-1/2" | 1-1/2" MPT | 4-3/8" | White | 16 | 8.2 | 42CP | |
| CPA-2000 | 130-20 | 2" | 2" MPT | 4-5/8" | White | 12 | 8.8 | 42CP | |

CTS Couplings & Tees *(Rated @ 150 PSI Static Pressure @ 72°F)*

PVC Couplings



CPVC Couplings



PVC Threaded Tee



| Part No. | Ref. No. | CTS Size | IPS Branch | Body Length | Color | Pkg. Qty. | Case (lbs.) | Product Class | Specifications |
|------------------|----------|-----------|------------|-------------|-------|-----------|-------------|---------------|-------------------------|
| PVC Couplings | | | | | | | | | |
| CCC-0500 | 210-05 | 1/2" UC | | 4" | White | 48 | 5.8 | 42CP | PVC NSF/ANSI 61+372 UPC |
| CCC-0750 | 210-07 | 3/4" UC | | 4" | White | 30 | 7.0 | 42CP | |
| CCC-1000 | 210-10 | 1" UC | | 5-1/4" | White | 24 | 8.2 | 42CP | |
| CCC-1250 | 210-12 | 1-1/4" UC | | 5-3/4" | White | 18 | 8.2 | 42CP | |
| CPVC Couplings | | | | | | | | | |
| 410-05 | | 1/2" UC | | 4" | Tan | 25 | 4.4 | 42CP | CPVC |
| 410-07 | | 3/4" UC | | 4" | Tan | 28 | 8.0 | 42CP | |
| 410-10 | | 1" UC | | 4-1/2" | Tan | 24 | 10.0 | 42CP | |
| PVC Threaded Tee | | | | | | | | | |
| CCT-0500 | 220-05 | 1/2" UC | 1/2" FPT | 4" | White | 36 | 8.2 | 42CP | PVC NSF/ANSI 61+372 |
| CCT-0750 | 220-07 | 3/4" UC | 3/4" FPT | 5" | White | 24 | 9.4 | 42CP | |
| CCT-1000 | 220-10 | 1" UC | 1" FPT | 5" | White | 18 | 9.1 | 42CP | |
| CCT-1250 | 220-12 | 1-1/4" UC | 1-1/4" FPT | 5-1/2" | White | 10 | 7.0 | 42CP | |
| CCT-1500 | 220-15 | 1-1/2" UC | 1-1/2" FPT | 6" | White | 8 | 7.8 | 42CP | |
| CCT-2000 | 220-20 | 2" UC | 2" FPT | 7-1/2" | White | 5 | 8.75 | 42CP | |

Note: All dimensions are nominal.

Wrenches

Strap Wrenches (Adjustable)



Stub Wrench



| Part No. | | Pkg. Qty. | Product Class | Specifications |
|-----------------------------|-------------------------------------|-----------|---------------|-----------------------------|
| Strap Wrenches (Adjustable) | | | | |
| BOA-104 | 1/2"-4" | 50 | 42CP | Plastic Handle Rubber Strap |
| BOA-106 | 1/2"-6" | 50 | 42CP | |
| Stub Wrench | | | | |
| SW-0500-C | 1/2" + 3/4" Plastic Riser Extractor | 25 | 42LS | Steel Handle |

FLO-LOCK™

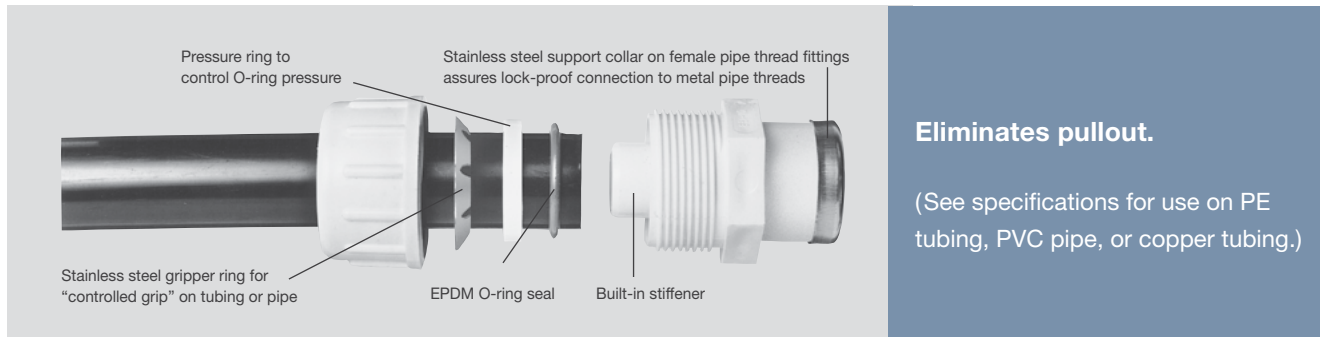

Eliminates pullout.

(See specifications for use on PE tubing, PVC pipe, or copper tubing.)

Tube Size SIDR-7 Pep Couplings & Adapters – Series 800 (Rated @ 200 PSI Static Pressure @ 72°F)

| | Part No. | Tube Size | Connection Size | Body Length | Color | Pkg. Qty. | Case (lbs.) | Product Class | Specifications |
|----------------|-----------------------|-------------|------------------------|-------------|-------|-----------|-------------|---------------|--|
| Coupling | Coupling | | | | | | | | |
| | 810-07 | 3/4" | 3/4" x 3/4" TS | 4-1/2" | White | 24 | 10.6 | 41FL | For use on Polyethylene Tube Size SIDR-7 |
| | 810-10 | 1" | 1" x 1" TS | 5" | White | 15 | 8.5 | 41FL | ASTM D-2239 |
| Male Adapter | Male Adapter | | | | | | | | |
| | 830-07 | 3/4" | 3/4" MPT x 3/4" TS | 2-5/8" | White | 20 | 5.0 | 41FL | For use on Polyethylene Tube Size SIDR-7 |
| | 830-10 | 1" | 1" MPT x 1" TS | 3-1/4" | White | 28 | 9.4 | 41FL | ASTM D-2239 |
| | 830-71 | 3/4" x 1" | 3/4" MPT x 1" TS | 3-1/2" | White | 18 | 5.5 | 41FL | PVC |
| | 830-121 | 1" x 1-1/4" | 1" MPT x 1-1/4" TS | 3" | White | 12 | 4.3 | 41FL | NSF/ANSI 61+372 UPC 830- 07/10 Only |
| Female Adapter | Female Adapter | | | | | | | | |
| | 831-07 | 3/4" | 3/4" FPT x 3/4" TS | 2-5/8" | White | 20 | 6.0 | 41FL | For use on Polyethylene Tube Size SIDR-7 |
| | 831-10 | 1" | 1" FPT x 1" TS | 2-7/8" | White | 28 | 10.8 | 41FL | ASTM D-2239 PVC NSF/ANSI 61+372 |
| Spigot Adapter | Spigot Adapter | | | | | | | | |
| | 833-07 | 3/4" | 3/4" IPS Spg x 3/4" TS | 3" | White | 20 | 5.0 | 41FL | For use on Polyethylene Tube Size SIDR-7 |
| | 833-71 | 3/4" x 1" | 3/4" IPS Spg x 1" TS | 3" | White | 20 | 7.0 | 41FL | ASTM D-2239 |
| | 833-10 | 1" | 1" IPS Spg x 1" TS | 3" | White | 28 | 9.4 | 41FL | PVC NSF/ANSI 61+372 UPC |

* Insert stiffener supplied must be used with this fitting.

FLOW MANAGEMENT

FLO-LOCK™

Tube Size SDR-9 CTS Couplings & Adapters – Series 700 (Rated @ 200 PSI Static Pressure @ 72°F)

PVC Couplings

| Part No. | Tube Size | Connection | Length Inches | Color | Pkg. Qty. | Case (lbs.) | Product Class | Specifications |
|-----------------------|-------------|----------------------------|---------------|-------|-----------|-------------|---------------|--|
| PVC Couplings | | | | | | | | |
| 710-07 | 3/4" | 3/4" x 3/4" TS | 4" | White | 35 | 9.8 | 41FL | For use on Polyethylene Tube Size SDR-9 ASTM D-2737 PVC NSF/ANSI 61+372 UPC |
| 710-10 | 1" | 1" x 1" TS | 4-1/2" | White | 24 | 9.4 | 41FL | |
| 710-17 | 3/4" x 1" | 1" SDR-9 x 3/4" SDR-11 | 4" | White | 36 | 11.8 | 41FL | |
| 710-12 | 1-1/4" | 1-1/4" x 1-1/4" TS | 5" | White | 15 | 8.5 | 41FL | |
| 710-15† | 1-1/2" | 1-1/2" x 1-1/4" TS | 6" | White | 16 | 13.0 | 41FL | |
| 710-20† | 2" | 2" x 2" TS | 7-1/2" | White | 12 | 15.9 | 41FL | |
| 710-17-9 | 3/4" x 1" | 1" SDR-9 x 3/4" SDR 9 | 4" | White | 36 | 11.8 | 41FL | |
| Male Adapter | | | | | | | | |
| 730-07 | 3/4" | 3/4" MPT x 3/4" TS | 2-5/8" | White | 25 | 4.75 | 41FL | For use on Polyethylene Tube Size SDR-9 ASTM D-2737 PVC UPC except 730-12-10 NSF/ANSI 61+372 |
| 730-71 | 3/4" x 1" | 3/4" MPT x 1" TS | 2-7/8" | White | 18 | 4.6 | 41FL | |
| 730-10 | 1" | 1" MPT x 1" TS | 2-7/8" | White | 18 | 4.6 | 41FL | |
| 730-12 | 1-1/4" | 1-1/4" MPT x 1-1/4" TS | 3-1/2" | White | 12 | 4.6 | 41FL | |
| 730-15 | 1-1/2" | 1-1/2" MPT x 1-1/2" TS | 3-1/2" | White | 18 | 9.1 | 41FL | |
| 730-20† | 2" | 2" MPT x 2" TS | 4" | White | 12 | 8.8 | 41FL | |
| Female Adapter | | | | | | | | |
| 731-07 | 3/4" | 3/4" FPT x 3/4" TS | 2-5/8" | White | 25 | 6.0 | 41FL | For use on Polyethylene Tube Size SDR-9 ASTM D-2737 PVC NSF/ANSI 61+372 |
| 731-71 | 3/4" x 1" | 3/4" FPT x 1" TS | 2-7/8" | White | 15 | 4.0 | 41FL | |
| 731-10 | 1" | 1" FPT x 1" TS | 3" | White | 15 | 4.8 | 41FL | |
| 731-12 | 1-1/4" | 1-1/4" FPT x 1-1/4" TS | 3-1/2" | White | 12 | 5.2 | 41FL | |
| 731-12-10 | 1" x 1-1/4" | 1" FPT x 1-1/4" TS | 3-1/2" | White | 12 | 5.2 | 41FL | |
| 731-15 | 1-1/2" | 1-1/2" FPT x 1-1/2" TS | 3-1/2" | White | 18 | 10.0 | 41FL | |
| 731-20† | 2" | 2" FPT x 2" TS | 3-3/4" | White | 12 | 8.2 | 41FL | |
| Spigot Adapter | | | | | | | | |
| 733-07 | 3/4" | 3/4" IPS Spg x 3/4" TS | 2-7/8" | White | 18 | 3.7 | 41FL | For use on Polyethylene Tube Size SDR-9 ASTM D-2737 PVC NSF/ANSI 61+372 UPC |
| 733-71 | 3/4" | 3/4" IPS Spg x 1" TS | 2-7/8" | White | 18 | 4.0 | 41FL | |
| 733-10 | 1" | 1" IPS Spg x 1" TS | 3-1/2" | White | 18 | 4.6 | 41FL | |
| 733-12 | 1-1/4" | 1-1/4" IPS Spg x 1-1/4" TS | 3-1/2" | White | 12 | 5.2 | 41FL | |
| 733-15 | 1-1/2" | 1-1/2" IPS Spg x 1-1/2" TS | 3-1/2" | White | 18 | 9.1 | 41FL | |
| 733-20† | 2" | 2" IPS Spg x 2" TS | 4" | White | 12 | 7.6 | 41FL | |

† Insert stiffener supplied must be used with this fitting.

Spigot Adapter

FLO-LOCK™

Couplings & Adapters – Series 100 - For use on PVC IPS Sizes (Rated @ 160 PSI Static Pressure @ 72°F)

| Part No. | IPS Size | Connection | Body Length | Color | Pkg. Qty. | Case (lbs.) | Product Class | Specifications |
|---|----------|------------|-------------|-------|-----------|-------------|---------------|---|
| PVC IPS Coupling with Flo-Lock | | | | | | | | |
| 112-05 | 1/2" | | 5" | White | 28 | 8.0 | 41FL | For use on IPS sizes ASTM D-1785 NSF/ANSI 61+372 |
| 112-07 | 3/4" | | 5-1/2" | White | 24 | 9.4 | 41FL | |
| 112-10 | 1" | | 5-3/4" | White | 15 | 8.5 | 41FL | |
| 112-12 | 1-1/4" | | 6-1/2" | White | 10 | 8.0 | 41FL | |
| 112-15 | 1-1/2" | | 7" | White | 16 | 14.6 | 41FL | |
| 112-20 | 2" | | 7-1/2" | White | 12 | 14.8 | 41FL | |
| PVC IPS Male Adapter with Flo-Lock | | | | | | | | |
| 135-05 | 1/2" | 1/2" MPT | 2-3/4" | White | 25 | 4.8 | 41FL | For use on IPS sizes ASTM D-1785 NSF/ANSI 61+372 UPC |
| 135-07 | 3/4" | 3/4" MPT | 3" | White | 20 | 5.0 | 41FL | |
| 135-10 | 1" | 1" MPT | 3-1/4" | White | 30 | 8.5 | 41FL | |
| 135-12 | 1-1/4" | 1-1/4" MPT | 3-1/2" | White | 20 | 8.0 | 41FL | |
| 135-15 | 1-1/2" | 1-1/2" MPT | 3-1/2" | White | 16 | 7.4 | 41FL | |
| 135-20 | 2" | 2" MPT | 4" | White | 12 | 8.8 | 41FL | |
| PVC IPS Female Adapter with Flo-Lock | | | | | | | | |
| 136-05 | 1/2" | 1/2" FPT | 2-3/4" | White | 25 | 4.8 | 41FL | For use on IPS sizes ASTM D-1785 NSF/ANSI 61+372 |
| 136-07 | 3/4" | 3/4" FPT | 3-1/4" | White | 20 | 5.0 | 41FL | |
| 136-10 | 1" | 1" FPT | 3-1/4" | White | 14 | 4.5 | 41FL | |
| 136-20 | 2" | 2" FPT | 4" | White | 10 | 8.0 | 41FL | |

Adapters – Series 200 & 900 - For use on Copper Tubing CTS Series (Rated @ 160 PSI Static Pressure @ 72°F)

| Part No. | CTS Size | Connection | Body Length | Color | Pkg. Qty. | Case (lbs.) | Product Class | Specifications |
|--|----------|---------------|-------------|-------|-----------|-------------|---------------|---|
| PVC CTS Male Adapter with Flo-Lock (Rated @ 160 PSI Static Pressure @ 72°F) | | | | | | | | |
| 235-05 | 1/2" | 1/2" MPT | 2-1/2" | White | 50 | 6.0 | 41FL | For use on CTS pipe ASTM B88 NSF/ANSI 61+372 UPC Except 235-20 |
| 235-07 | 3/4" | 3/4" MPT | 2-3/4" | White | 25 | 4.8 | 41FL | |
| 235-10 | 1" | 1" MPT | 3" | White | 18 | 4.6 | 41FL | |
| 235-12 | 1-1/4" | 1-1/4" MPT | 3-1/4" | White | 24 | 7.0 | 41FL | |
| 235-15 | 1-1/2" | 1-1/2" MPT | 3-1/2" | White | 20 | 8.5 | 41FL | |
| 235-20 | 2" | 2" MPT | 4" | White | 12 | 7.6 | 41FL | |
| PVC CTS Female Adapter with Flo-Lock | | | | | | | | |
| 935-07 | 3/4" | 3/4" Spg | 2-7/8" | White | 20 | 4.5 | 41FL | For use on CTS pipe ASTM B88 NSF/ANSI 61+372 |
| 935-10 | 1" | 1" Spg | 2-7/8" | White | 20 | 5.0 | 41FL | |
| 935-12 | 1-1/4" | 1-1/4" Socket | 3-5/16" | White | 25 | 8.5 | 41FL | |
| 935-125 | 1-1/4" | 1-1/2" Socket | 3-5/16" | White | 20 | 7.0 | 41FL | |
| 935-15 | 1-1/2" | 1-1/2" Socket | 4" | White | 20 | 10.0 | 41FL | |
| 935-20 | 2" | 2" Socket | 4" | White | 12 | 7.6 | 41FL | |

EXPANSION REPAIR COUPLINGS

Pro-Span™



| Part No. | IPS Size | Body Length | Color | Pkg. Qty. | Case (lbs.) | Product Class | Specifications |
|----------|----------------|-------------|-------|-----------|-------------|---------------|---|
| 118-05 | 1/2" S x SPG | 7-1/2" | White | 28 | 6.6 | 41XC | PVC 118-05 Thru 25: NSF/ANSI 14 UPC Rated @200 PSI Static Pressure @72°F |
| 118-07 | 3/4" S x SPG | 7-3/4" | White | 24 | 8.2 | 41XC | |
| 118-10 | 1" S x SPG | 9-1/2" | White | 15 | 8.5 | 41XC | |
| 118-12 | 1-1/4" S x SPG | 10-3/4" | White | 10 | 8.0 | 41XC | |
| 118-15 | 1-1/2" S x SPG | 12-3/4" | White | 16 | 17.8 | 41XC | |
| 118-20 | 2" S x SPG | 13-1/2" | White | 12 | 17.8 | 41XC | |
| 118-25 | 2-1/2" S x SPG | 18-3/4" | White | 3 | 9.55 | 41XC | |
| 118-30 | 3" S x SPG | 21" | White | 3 | 13.3 | 41XC | |
| 118-40 | 4" S x SPG | 22-3/4" | White | 3 | 20.5 | 41XC | |
| 118-60QF | 6" S x S | 26-1/4" | White | 1 | 13.8 | 42RF | |

QF-6000 IS NOW P/N 118-60QF, AND CARRIES THE SAME SPECIFICATIONS

FOOT VALVES (SPRING CHECK)

Foot Valve



Foot Valve Screens



| Part No. | IPS Size | Body Length | Color | Pkg. Qty. | Case (lbs.) | Product Class | Specifications |
|---------------------------|----------|-------------|-------|-----------|-------------|---------------|---------------------------------------|
| Foot Valve | | | | | | | |
| 1001-10FV | 1" | 7" | White | 20 | 9.0 | 41CV | PVC Rated @ 200 PSI @ 72°F |
| 1001-12FV | 1-1/4" | 8" | White | 15 | 13.0 | 41CV | |
| 1001-15FV | 1-1/2" | 8-1/2" | White | 15 | 13.8 | 41CV | |
| 1001-20FV | 2" | 10-1/2" | White | 10 | 16.0 | 41CV | |
| Foot Valve Screens | | | | | | | |
| 1800-07 | 3/4" | 2" | Black | 24 | 1.5 | 41CV | Material: Polyethylene 100 mesh |
| 1800-10 | 1" | 2" | Black | 15 | 1.6 | 41CV | |
| 1800-12 | 1-1/4" | 2-1/4" | Black | 10 | 1.5 | 41CV | |
| 1800-15 | 1-1/2" | 2" | Black | 16 | 2.0 | 41CV | |
| 1800-20 | 2" | 2-3/4" | Black | 12 | 2.2 | 41CV | |

SPRING CHECK VALVES

Spring Check Valves – PVC – Series 1001, 1002, 1011, 1012 (Rated @ 200 PSI Static Pressure @ 72°F)

FPT x FPT EPDM Gasket



S x S EPDM Gasket



S x S Clear PVC EPDM Gasket



| Part No. | Ref. No. | Spring Tension | IPS Size Connection | Body Length | Color | Pkg. Qty. | Case (lbs.) | Product Class | Specifications |
|------------------------------------|------------|----------------|---------------------|-------------|-------|-----------|-------------|---------------|---------------------------|
| FPT x FPT EPDM Gasket | | | | | | | | | |
| 1001-05 | KC-0500-T | 1/2 lb. | 1/2" | 4-1/8" | White | 20 | 5.0 | 41CV | PVC NSF/ANSI 61+372 |
| 1001-07 | KC-0750-T | 1/2 lb. | 3/4" | 4-1/8" | White | 20 | 6.0 | 41CV | |
| 1001-10 | KC-1000-T | 1/2 lb. | 1" | 5-1/4" | White | 20 | 8.0 | 41CV | |
| 1001-12 | KC-1250-T | 1/2 lb. | 1-1/4" | 6-3/16" | White | 15 | 13.0 | 41CV | |
| 1001-15 | KC-1500-T | 1/2 lb. | 1-1/2" | 6-3/16" | White | 15 | 13.8 | 41CV | |
| 1001-20 | KC-2000-T | 1/2 lb. | 2" | 7-1/2" | White | 10 | 15.0 | 41CV | |
| 1001-25 | | 1/2 lb. | 2-1/2" | 8-5/8" | White | 8 | 27.0 | 41CV | |
| 1001-30 | | 1/2 lb. | 3" | 8-5/8" | White | 8 | 27.4 | 41CV | |
| 1002-05 | | 2 lb. | 1/2" | 4-1/8" | White | 20 | 5.0 | 41CV | |
| 1002-07 | KC2-0750-T | 2 lb. | 3/4" | 4-1/8" | White | 20 | 6.0 | 41CV | |
| 1002-10 | KC2-1000-T | 2 lb. | 1" | 5-1/4" | White | 20 | 8.0 | 41CV | |
| 1002-12 | KC2-1250-T | 2 lb. | 1-1/4" | 6-3/16" | White | 15 | 13.0 | 41CV | |
| 1002-15 | KC2-1500-T | 2 lb. | 1-1/2" | 6-3/16" | White | 15 | 13.8 | 41CV | |
| 1002-20 | KC2-2000-T | 2 lb. | 2" | 7-1/2" | White | 10 | 15.0 | 41CV | |
| 1002-25 | | 2 lb. | 2-1/2" | 8-5/8" | White | 8 | 27.0 | 41CV | |
| 1002-30 | | 2 lb. | 3" | 8-5/8" | White | 8 | 27.4 | 41CV | |
| S x S EPDM Gasket | | | | | | | | | |
| 1011-05-025 | | 1/4 lb. | 1/2" | 4-1/8" | White | 20 | 5.0 | 41CV | PVC NSF/ANSI 61+372 |
| 1011-07-025 | | 1/4 lb. | 3/4" | 4-1/8" | White | 20 | 5.0 | 41CV | |
| 1011-05 | KC-0500-S | 1/2 lb. | 1/2" | 4-1/8" | White | 20 | 5.0 | 41CV | |
| 1011-07 | KC-0750-S | 1/2 lb. | 3/4" | 4-1/8" | White | 20 | 5.0 | 41CV | |
| 1011-10 | KC-1000-S | 1/2 lb. | 1" | 5-1/4" | White | 20 | 9.0 | 41CV | |
| 1011-12 | KC-1250-S | 1/2 lb. | 1-1/4" | 6-3/16" | White | 15 | 12.3 | 41CV | |
| 1011-15 | KC-1500-S | 1/2 lb. | 1-1/2" | 6-1/2" | White | 15 | 13.0 | 41CV | |
| 1011-20 | KC-2000-S | 1/2 lb. | 2" | 7" | White | 10 | 14.5 | 41CV | |
| 1011-25 | | 1/2 lb. | 2-1/2" | 8-5/8" | White | 8 | 25.8 | 41CV | |
| 1011-30 | | 1/2 lb. | 3" | 8-5/8" | White | 8 | 25.4 | 41CV | |
| 1012-05 | KC2-0500-S | 2 lb. | 1/2" | 4-1/8" | White | 20 | 5.0 | 41CV | |
| 1012-07 | KC2-0750-S | 2 lb. | 3/4" | 4-1/8" | White | 20 | 5.0 | 41CV | |
| 1012-10 | KC2-1000-S | 2 lb. | 1" | 5-1/4" | White | 20 | 9.0 | 41CV | |
| 1012-12 | KC2-1250-S | 2 lb. | 1-1/4" | 6-3/16" | White | 15 | 12.3 | 41CV | |
| 1012-15 | KC2-1500-S | 2 lb. | 1-1/2" | 6-1/2" | White | 15 | 13.0 | 41CV | |
| 1012-20 | KC2-2000-S | 2 lb. | 2" | 7" | White | 10 | 14.5 | 41CV | |
| 1012-25 | | 2 lb. | 2-1/2" | 8-5/8" | White | 8 | 25.8 | 41CV | |
| 1012-30 | | 2 lb. | 3" | 8-5/8" | White | 8 | 25.4 | 41CV | |
| 1015-25 | | 5 lb. | 2-1/2" | 8-5/8" | White | 8 | 25.8 | 41CV | |
| S x S Clear PVC EPDM Gasket | | | | | | | | | |
| 1011C10 | KCC-1000-S | 1/2 lb. | 1" | 5-1/4" | Clear | 20 | 8.0 | 41CV | Clear PVC NSF/ANSI 61+372 |
| 1011C12 | KCC-1250-S | 1/2 lb. | 1-1/4" | 6-3/16" | Clear | 15 | 12.3 | 41CV | |
| 1011C15 | KCC-1500-S | 1/2 lb. | 1-1/2" | 6-1/2" | Clear | 15 | 13.0 | 41CV | |
| 1011C20 | KCC-2000-S | 1/2 lb. | 2" | 7" | Clear | 10 | 14.0 | 41CV | |

SPRING CHECK VALVES

Spring Check Valves – PVC – Series 1700, 1090, 1136 *(Rated @ 200 PSI Static Pressure @ 72°F)*

White PVC True Union



Clear PVC True Union



Compact White PVC True Union



Compact Clear PVC True Union



CPVC 90°



Inline Valve and Bypass Valve







Hose Thread (EPDM Gasket)



| Part No. | Spring Tension | IPS Size & Connection | Body Length | Color | Pkg. Qty. | Case (lbs.) | Product Class | Specifications |
|--------------------------------------|----------------|-----------------------|-------------|-------|-----------|-------------|---------------|---|
| White PVC True Union | | | | | | | | |
| 1700-07 | 1/2 lb. | 3/4" S x S | 6-1/4" | White | 20 | 10.0 | 41CV | Rated @ 200 PSI Static Pressure @ 72°F NSF/ANSI 61+372 |
| 1700-10 | 1/2 lb. | 1" S x S | 6-3/4" | White | 20 | 14.0 | 41CV | |
| 1700-15 | 1/2 lb. | 1-1/2" S x S | 8-1/4" | White | 12 | 15.4 | 41CV | |
| 1700-20 | 1/2 lb. | 2" S x S | 9-3/4" | White | 12 | 25.6 | 41CV | |
| 1702-15 | 2 lb. | 1-1/2" S x S | 8-1/4" | White | 12 | 15.4 | 41CV | |
| 1702-20 | 2 lb. | 2" S x S | 9-3/4" | White | 12 | 25.6 | 41CV | |
| Clear PVC True Union | | | | | | | | |
| 1700C07 | 1/2 lb. | 3/4" S x S | 6-1/4" | Clear | 20 | 10.0 | 41CV | Clear body with white nut and tailpiece Rated @ 200 PSI Static Pressure @ 72°F NSF/ANSI 61+372 |
| 1700C10 | 1/2 lb. | 1" S x S | 6-3/4" | Clear | 20 | 14.0 | 41CV | |
| 1700C15 | 1/2 lb. | 1-1/2" S x S | 8-1/4" | Clear | 12 | 15.4 | 41CV | |
| 1700C20 | 1/2 lb. | 2" S x S | 9-3/4" | Clear | 12 | 25.6 | 41CV | |
| 1700C30 | 1/2 lb. | 3" S x S | 13-1/4" | Clear | 6 | 28.3 | 41CV | |
| 1702C15 | 2 lb. | 1-1/2" S x S | 8-1/4" | Clear | 12 | 15.4 | 41CV | |
| 1702C20 | 2 lb. | 2" S x S | 9-3/4" | Clear | 12 | 25.6 | 41CV | |
| Compact White PVC True Union | | | | | | | | |
| 1790-15 | 1/2 lb. | 1-1/2" S x S | 6-1/2" | White | 15 | 13.8 | 41CV | Rated @ 200 PSI Static Pressure @ 72°F NSF/ANSI 61+372 |
| 1790-20 | 1/2 lb. | 2" S x S | 7-3/8" | White | 10 | 14.0 | 41CV | |
| Compact Clear PVC True Union | | | | | | | | |
| 1790C15 | 1/2 lb. | 1-1/2" S x S | 6-1/2" | Clear | 15 | 13.8 | 41CV | Rated @ 200 PSI Static Pressure @ 72°F Clear body with white nut and tailpiece |
| 1790C20 | 1/2 lb. | 2" S x S | 7-3/8" | Clear | 10 | 14.0 | 41CV | |
| 1795C20 | 5 lb. | 2" S x S | 7-3/8" | Clear | 10 | 14.0 | 41CV | |
| CPVC 90° | | | | | | | | |
| 1901-15 | 1 lb. | 1-1/2" S x S | 5" | Tan | 12 | 8.8 | 41CV | Rated @ 125 PSI Static Pressure @ 160°F |
| 1903-15 | 3 lb. | 1-1/2" S x S | 5" | Tan | 12 | 8.8 | 41CV | |
| 1901-20 | 1 lb. | 2" S x 2-1/2" Spg | 5-1/2" | Tan | 12 | 13.6 | 41CV | |
| 1903-20 | 3 lb. | 2" S x 2-1/2" Spg | 5-1/2" | Tan | 12 | 13.6 | 41CV | |
| Inline Valve and Bypass Valve | | | | | | | | |
| 1091-20 | 1/2 lb. | 2" S x S | 5" | White | 12 | 6.9 | 41CV | Non-Adjustable EPDM Seal Rated @ 200 PSI Static Pressure @ 72°F NSF/ANSI 61+372 |
| 1095-20 | 5 lb. | 2" S x S | 5" | White | 12 | 6.9 | 41CV | |
| Hose Thread (EPDM Gasket) | | | | | | | | |
| 1136-07 | 1/2 lb. | 3/4" MHT x 3/4" FHT | 4-1/8" | White | 20 | 5.0 | 41CV | Rated @ 200 PSI Static Pressure @ 72°F NSF/ANSI 61+372 |
| 1136-07-05 | 5 lb. | 3/4" MHT x 3/4" FHT | 4-1/8" | White | 20 | 5.0 | 41CV | |

SPRING CHECK VALVES

Spa Spring Check Valves

| | Part No. | Spring Tension | IPS Size & Connection | Body Length | Color | Pkg. Qty. | Case (lbs.) | Product Class | Specifications | |
|---|------------------------------|-------------------|-----------------------|-------------------|--------|-----------|-------------|---------------|---|-----------|
| Versa Drain  | Versa Drain | | | | | | | | | |
| | 107015BK | N/A | N/A | 6" | Black | 12 | 6.4 | 41CV | Drain for portable spa | |
| | 1071GH | N/A | N/A | 3" | | 1 | - | 41CV | Garden Hose Adpt. | |
| Spa Check Valve  | Spa Check Valve | | | | | | | | | |
| | 105010 | 1/4 lb. | 1" S x 1-1/4" Spg | 3-3/8" | White | 20 | 5.0 | 41CV | 1/4 lb. for air blowers Rated @ 200 PSI Static Pressure @ 72°F | |
| | 105020 | 1/4 lb. | 1-1/2" S x 2" Spg | 5-1/8" | White | 12 | 8.2 | 41CV | | |
| Clear Spa Check Valve  | Clear Spa Check Valve | | | | | | | | | |
| | 1050C10 | 1/4 lb. | 1" S x 1-1/4" Spg | 3-3/8" | Clear | 20 | 5.0 | 41CV | Clear PVC 1/4 lb. for air blowers Rated @ 200 PSI Static Pressure @ 72°F | |
| | 1050C20 | 1/4 lb. | 1-1/2" S x 2" Spg | 5-1/8" | Clear | 12 | 7.6 | 41CV | | |
| | 1050C20-05 | 1/2 lb. | 1-1/2" S x 2" Spg | 5-1/8" | Clear | 12 | 7.6 | 41CV | | |
| | 1050C20-10 | 10 lb. | 1-1/2" S x 2" Spg | 5-1/8" | Clear | 12 | 7.6 | 41CV | | |
| | | 1050C20-12 | 12 lb. | 1-1/2" S x 2" Spg | 5-1/8" | Clear | 12 | 7.6 | 41CV | UL Listed |
| | | 1050C20-15 | 15 lb. | 1-1/2" S x 2" Spg | 5-1/8" | Clear | 12 | 7.6 | 41CV | |
| | | 1053C20 | 3 lb. | 1-1/2" S x 2" Spg | 5-1/8" | Clear | 12 | 7.6 | 41CV | |
| | 1055C20 | 5 lb. | 1-1/2" S x 2" Spg | 5-1/8" | Clear | 12 | 7.6 | 41CV | | |
| Clear Compact  | Clear Compact | | | | | | | | | |
| | S1050C20 | 1/4 lb. | 1-1/2" S x 2" Spg | 4" | Clear | 12 | 6 | 41CV | Clear PVC 1/4 lb. for air blowers Rated @ 200 PSI Static Pressure @ 72°F | |
| | S1050C20-05 | 1/2 lb. | 1-1/2" S x 2" Spg | 4" | Clear | 12 | 6 | 41CV | | |
| S1052C20 | 2 lb. | 1-1/2" S x 2" Spg | 4" | Clear | 12 | 6 | 41CV | | | |

Adjustable Spring Check Valves – Series 1200, 1700 *(Rated @ 200 PSI Static Pressure @ 72°F)*

| | Part No. | Spring Tension | IPS Size & Connection | Body Length | Color | Pkg. Qty. | Case (lbs.) | Product Class | Specifications |
|---|----------------------------|--------------------|-----------------------|-----------------|-------|-----------|-------------|---------------|--|
| White PVC FPT x FPT Factory Set at 5 lb.  | White PVC FPT x FPT | | | | | | | | |
| | 1205-05 | 2 – 5 lb. | 1/2" | 4-1/8" | White | 20 | 5.0 | 41CV | Adjusting nut 1-1/2 turn = 1 lb. force NSF/ANSI 61+372 Except: 1205V07 |
| | 1205-07 | 2-1/2 – 5 lb. | 3/4" | 4-1/8" | White | 20 | 5.0 | 41CV | |
| | 1205-10 | 4-1/8 – 17 lb. | 1" | 5-1/4" | White | 20 | 9.0 | 41CV | |
| | 1205-12 | 4 – 50 lb. | 1-1/4" | 6-3/16" | White | 15 | 12.3 | 41CV | |
| | 1205-15 | 3-1/2 – 50 lb. | 1-1/2" | 6-3/16" | White | 15 | 12.3 | 41CV | |
| | 1205-20 | 1-3/4 – 14-1/2 lb. | 2" | 7-1/2" | White | 10 | 15.5 | 41CV | |
| | 1205-07-20 | 20 lb. | 3/4" | 4-1/8" | White | 20 | 5.0 | 41CV | |
| | 1205V07 | 5 lb. | 3/4" w/VITON | 4-1/8" | White | 20 | 5.0 | 41CV | |
| | White PVC S x S | | | | | | | | |
| White PVC S x S  | 1225-07 | 2-1/2 – 5 lb. | 3/4" | 4-1/8" | White | 20 | 4.5 | 41CV | Adjusting nut 1-1/2 turn = 1 lb. force NSF/ANSI 61+372 Except: 1228V15 |
| | 1225-10 | 4-1/4 – 17 lb. | 1" | 5-1/4" | White | 20 | 8.5 | 41CV | |
| | 1225-15 | 3-1/2 – 50 lb. | 1-1/2" | 6-3/16" | White | 15 | 13.5 | 41CV | |
| | 1228V15 | 30 lb. | 1-1/2" | 6-3/16" w/VITON | White | 15 | 12.5 | 41CV | |

SPRING CHECK VALVES

White PVC
FPT x MPT



White PVC
True Union



Vacuum
Relief Valve
Factory Set
at 1/2 lb.



| Part No. | Spring Tension | IPS Size | Body Length | Color | Pkg. Qty. | Case (lbs.) | Product Class | Specifications |
|----------------------|----------------|-------------------|-------------|-------|-----------|-------------|---------------|---|
| White PVC FPT x MPT | | | | | | | | |
| 1235-05 | 2 – 4-1/2 lb. | 1/2" | 4-1/8" | White | 20 | 4.5 | 41CV | PVC. Adjusting nut 1-1/2 turn = 1 lb. force NSF/ANSI 61+372 |
| 1235-07 | 2-1/2 – 5 lb. | 3/4" | 4-1/8" | White | 20 | 4.5 | 41CV | |
| 1235-10 | 4-1/4 – 17 lb. | 1" | 5-1/4" | White | 20 | 8.5 | 41CV | |
| 1235-05-30 | 30 lb. | 1/2" | 4-1/8" | White | 20 | 4.5 | 41CV | |
| White PVC True Union | | | | | | | | |
| 1750-20 | 1 – 14 lb. | 2" U x U | 9-3/4" | White | 10 | 23.0 | 41CV | PVC. Adjusting nut 1-1/2 turn = 1 lb. force NSF/ANSI 61+372 |
| 1753-20 | 15 – 30 lb. | 2" U x U | 9-3/4" | White | 10 | 23.0 | 41CV | |
| Vacuum Relief Valve | | | | | | | | |
| 1171V57 | 1/2 lb. | 1/2" S x 3/4" MPT | 4-1/8" | Black | 20 | 4.0 | 41CV | Adjusting nut 1-1/2 turn = 1 lb. force. Polypropylene with cap and VITON seals Not yet rated |

Adjustable Inline Spring Check Valve

FLOW MANAGEMENT

FF



FM



MF



WCV



UCV



| Part No. | Ref. No. | IPS Size & Connection | Body Length | Pkg. Qty. | Case (lbs.) | Product Class | Specifications |
|----------------------|----------|-----------------------|-------------|-----------|-------------|---------------|---|
| Gray PVC | | | | | | | |
| CV-0500-FF | 1100-05 | 1/2" FPT x FPT | 2-3/4" | 100 | 11.0 | 41CV | Preset @ approx. 5 lb. with EPDM Seal. Adjusting nut 1-1/2 turn = 1 lb. force |
| CV-0500-FM | | 1/2" FPT x MPT | 2-1/2" | 100 | 11.0 | 41CV | |
| CV-0500-MF | 1101-05 | 1/2" MPT x FPT | 2-3/4" | 100 | 11.0 | 41CV | |
| CV-0575-FM | | 1/2" FPT x 3/4" MPT | 2-1/2" | 100 | 13.0 | 41CV | |
| CV-0750-FF | 1100-07 | 3/4" FPT x FPT | 3" | 60 | 8.2 | 41CV | |
| CV-0750-FM | 1102-07 | 3/4" FPT x MPT | 2-7/8" | 60 | 8.2 | 41CV | |
| CV-0750-MF | 1101-07 | 3/4" MPT x FPT | 2-7/8" | 60 | 8.2 | 41CV | |
| CV-1000-FF | 1100-10 | 1" FPT x FPT | 3" | 40 | 9.0 | 41CV | |
| CV-1000-FM | | 1" FPT x MPT | 3" | 40 | 7.0 | 41CV | |
| CV-1000-MF | | 1" MPT x FPT | 3" | 40 | 7.0 | 41CV | |
| White PVC | | | | | | | |
| WCV-1000-MF | | 1" MPT x FPT | 3" | 40 | 7.0 | 41CV | Preset @ approx. 5 lb. with EPDM Seal. Adjusting nut 1-1/2 turn = 1 lb. force |
| UV Resistant Tan PVC | | | | | | | |
| UCV-0500-FF | | 1/2" FPT x FPT | 2-3/4" | 100 | 11.0 | 41CV | UV Resistant PVC |
| UCV-0500-MF | | 1/2" MPT x FPT | 2-3/4" | 100 | 11.0 | 41CV | |
| UCV-0750-FF | | 3/4" FPT x FPT | 3" | 60 | 8.2 | 41CV | |
| UCV-0750-MF | | 3/4" MPT x FPT | 2-7/8" | 60 | 8.2 | 41CV | |
| UCV-1000-FF | | 1" FTP x FPT | 3" | 40 | 9.0 | 41CV | |

Breakaway Coupling Valves

Flo-Check
Breakaway
Coupling —
Cal Trans
Orange



| Part No. | IPS Size & Connection | Body Length | Color | Pkg. Qty. | Case (lbs.) | Product Class | Specifications |
|---|-----------------------|-------------|--------|-----------|-------------|---------------|---|
| Flo-Check Breakaway Coupling – Cal Trans Orange | | | | | | | |
| 1010-05-0 | 1/2" FPT x 1/2" FPT | 2-1/4" | Orange | 30 | 2.5 | 41CV | Rated @ 150 PSI Static Pressure @ 72°F |
| 1010-07-0 | 3/4" FPT x 3/4" FPT | 2-3/8" | Orange | 25 | 3.5 | 41CV | |

Note: To be used on galvanized or iron pipe only.

SWING CHECK VALVES

Swing Check Valves – Series 1500 (Rated @ 125 PSI Static Pressure @ 72°F)

| | Part No. | Ref. No. | IPS Size & Connection | Body Length | Color | Pkg. Qty. | Case (lbs.) | Product Class | Specifications |
|--|-----------------------|----------------------------|------------------------|-------------|-------|-----------|-------------|---|---|
|  <p>White PVC Compression</p> | White PVC Compression | | | | | | | | |
| | 1500-12 | KSC-1250-C | 1-1/4" UC x UC | 8-1/2" | White | 12 | 13.6 | 41CV | NSF/ANSI 61+372 |
| | 1500-15 | KSC-1500-C | 1-1/2" UC x UC | 8-1/2" | White | 12 | 14.2 | 41CV | |
| | 1500-20 | KSC-2000-C | 2" UC x UC | 9-1/2" | White | 12 | 20.8 | 41CV | |
| 1500-30 | KSC-3000-C | 3" UC x UC | 13-3/8" | White | 2 | 10.1 | 41CV | | |
|  <p>Clear PVC Compression</p> | Clear PVC Compression | | | | | | | | |
| | 1500C15 | KSCC-1500-C | 1-1/2" UC x UC | 8-1/2" | Clear | 12 | 14.2 | 41CV | Clear PVC with white CAPS NFS/ANSI 61+372 |
| 1500C20 | KSCC-2000-C | 2" UC x UC | 9-31/2" | Clear | 12 | 20.8 | 41CV | | |
|  <p>White PVC Threaded</p> | White PVC Threaded | | | | | | | | |
| | 1520-05F | KSC-0500-T | 1/2" FPT x FPT | 3-1/2" | White | 20 | 4.0 | 41CV | PVC NSF/ANSI 61+372 |
| | 1520-07F | KSC-0750-T | 3/4" FPT x FPT | 3-1/2" | White | 25 | 6.0 | 41CV | |
| | 1520-10F | KSC-1000-T | 1" FPT x FPT | 5-1/8" | White | 25 | 9.8 | 41CV | |
| | 1520-12F | KSC-1250-T | 1-1/4" FPT x FPT | 5-1/4" | White | 12 | 7.6 | 41CV | |
| | 1520-15F | KSC-1500-T | 1-1/2" FPT x FPT | 5-3/4" | White | 12 | 8.2 | 41CV | |
| 1520-20F | KSC-2000-T | 2" FPT x FPT | 6" | White | 12 | 12.4 | 41CV | | |
|  <p>White PVC S x S</p> | White PVC S x S | | | | | | | | |
| | 1520-05 | KSC-0500-S | 1/2" S x S | 3-1/2" | White | 20 | 4.0 | 41CV | PVC NSF/ANSI 61+372 Except: 1520V20 |
| | 1520-07 | KSC-0750-S | 3/4" S x S | 3-1/2" | White | 25 | 6.0 | 41CV | |
| | 1520-10 | KSC-1000-S | 1" S x S | 5-1/8" | White | 25 | 9.8 | 41CV | |
| | 1520-12 | KSC-1250-S | 1-1/4" S x S | 5-1/4" | White | 12 | 7.6 | 41CV | |
| | 1520-15 | KSC-1500-S | 1-1/2" S x S | 5-3/4" | White | 12 | 8.2 | 41CV | |
| | 1520-20 | KSC-2000-S | 2" S x S | 6" | White | 12 | 12.4 | 41CV | |
| | 1520-30 | | 3" S x S | 9" | White | 4 | 11.0 | 41CV | |
| | 1520-40 | | 4" S x S | 9-1/2" | White | 1 | 4.3 | 41CV | |
| | 1520V20 | | 2" S x S w/ VITON Seal | 6" | White | 12 | 12.4 | 41CV | |
|  <p>Clear PVC Threaded</p> | Clear PVC Threaded | | | | | | | | |
| | 1520C05F | KSCC-0500-T | 1/2" FPT x FPT | 3-1/2" | Clear | 20 | 4.0 | 41CV | Clear PVC NSF/ANSI 61+372 |
| | 1520C07F | KSCC-0750-T | 3/4" FPT x FPT | 3-1/2" | Clear | 25 | 6.0 | 41CV | |
| | 1520C10F | KSCC-1000-T | 1" FPT x FPT | 5-1/8" | Clear | 25 | 9.8 | 41CV | |
| | 1520C15F | KSCC-1500-T | 1-1/2" FPT x FPT | 5-3/4" | Clear | 12 | 7.6 | 41CV | |
| | 1520C15FV | KSCC-1500-T | 1-1/2" FPT x FPT | 5-3/4" | Clear | 12 | 7.0 | 41CV | |
| | 1520C20F | KSCC-2000-T | 2" FPT x FPT | 6" | Clear | 12 | 8.2 | 41CV | |
| 1520C05 | KSCC-0500-S | 1/2" S x S | 3-1/2" | Clear | 20 | 4.0 | 41CV | Clear PVC NSF/ANSI 61+372 Except 1520C15V, 1520C20V | |
| 1520C07 | KSCC-0750-S | 3/4" S x S | 3-1/2" | Clear | 25 | 6.0 | 41CV | | |
| 1520C10 | KSCC-1000-S | 1" S x S | 5-1/8" | Clear | 25 | 9.8 | 41CV | | |
| 1520C12 | KSCC-1250-S | 1-1/4" S x S | 5-1/4" | Clear | 12 | 7.6 | 41CV | | |
| 1520C15 | KSCC-1500-S | 1-1/2" S x S | 5-3/4" | Clear | 12 | 8.2 | 41CV | | |
| 1520C20 | KSCC-2000-S | 2" S x S | 6" | Clear | 12 | 12.4 | 41CV | | |
| 1520C30 | | 3" S x S | 9" | Clear | 4 | 11.0 | 41CV | | |
| 1520C40 | | 4" S x S | 9-1/2" | Clear | 1 | 4.3 | 41CV | | |
| 1520C15V | | 1-1/2" S x S w/ VITON Seal | 5-3/4" | Clear | 12 | 8.2 | 41CV | | |

FLOW MANAGEMENT

SWING CHECK VALVES

Swing Check Valves – Series 1700 & Low-Profile (Rated @ 125 PSI Static Pressure @ 72°F)

White PVC True Union



Clear PVC True Union



PVC Low-Profile Swing Check Valve



| Part No. | Ref. No. | IPS Size & Connection | Body Length | Color | Pkg. Qty. | Case (lbs.) | Product Class | Specifications |
|-----------------------------------|--------------|-----------------------|-------------|-------|-----------|-------------|---------------|---|
| White PVC True Union | | | | | | | | |
| 1720-07 | | 3/4" U x U | 5-1/2" | White | 20 | 10.0 | 41CV | PVC NSF/ANSI 61+372 |
| 1720-10 | | 1" U x U | 6-7/8" | White | 20 | 15.0 | 41CV | |
| 1720-15 | KSC-1500-SU | 1-1/2" U x U | 8" | White | 12 | 14.2 | 41CV | |
| 1720-20 | KSC-2000-SU | 2" U x U | 9-5/8" | White | 12 | 22.6 | 41CV | |
| 1720-30 | KSC-3000-SU | 3" U x U | 13-1/4" | White | 6 | 24.7 | 41CV | |
| Clear PVC True Union | | | | | | | | |
| 1720C07 | KSCC-0750-SU | 3/4" U x U | 5-1/2" | Clear | 20 | 10.0 | 41CV | PVC Clear body with white nuts and tailpieces NSF/ANSI 61+372 |
| 1720C10 | KSCC-1000-SU | 1" U x U | 6-7/8" | Clear | 20 | 15.0 | 41CV | |
| 1720C15 | KSCC-1500-SU | 1-1/2" U x U | 8" | Clear | 12 | 14.2 | 41CV | |
| 1720C20 | KSCC-2000-SU | 2" U x U | 9-5/8" | Clear | 12 | 22.6 | 41CV | |
| 1720C30 | KSCC-3000-SU | 3" U x U | 13-1/4" | Clear | 6 | 24.7 | 41CV | |
| PVC Low-Profile Swing Check Valve | | | | | | | | |
| KSL-0750-S | | 3/4" | 5" | White | 18 | 8.2 | 41CV | PVC NSF/ANSI 61+372 |
| KSL-1000-S | | 1" | 4-3/4" | White | 18 | 7.3 | 41CV | |
| KSL-1250-S | | 1-1/4" | 5-1/4" | White | 12 | 8.2 | 41CV | |
| KSL-1500-S | | 1-1/2" | 5-1/2" | White | 12 | 8.8 | 41CV | |
| KSL-2000-S | | 2" | 6-1/2" | White | 8 | 8.2 | 41CV | |

Sump Pump Valves (Rated @ 125 PSI Static Pressure @ 72°F)

Sump Pump Valve



| Part No. | Ref. No. | IPS Size & Connection | Body Length | Check Valve Color | Pkg. Qty. | Case (lbs.) | Product Class | Specifications |
|-----------------|----------|-----------------------|-------------|-------------------|-----------|-------------|---------------|---|
| Sump Pump Valve | | | | | | | | |
| 1400-15 | | 1-1/4" or 1-1/2" UC | 5-1/4" | White | 12 | 7.6 | 41CV | Buna "N" Gaskets are included in both 1-1/4" and 1-1/2" size applications |

Checkmate (Rated @ 125 PSI Static Pressure @ 72°F)

U x S



U x U



UC x UC

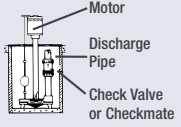

| Part No. | Ref. No. | IPS Size & Connection | Body Length | Check Valve Color | Pkg. Qty. | Case (lbs.) | Product Class | Specifications |
|-----------|------------|-----------------------|-------------|-------------------|-----------|-------------|---------------|---|
| Checkmate | | | | | | | | |
| 2200-15 | BCX-1500-S | 1-1/2" U x S | 8" | White | 12 | 19.6 | 41BV |  |
| 2200-15UC | | 1-1/2" UC x UC | 10-3/4" | White | 12 | 24.4 | 41BV | |
| 2200-15TU | | 1-1/2" U x U | 10-1/2" | White | 12 | 25.6 | 41BV | |
| 2200-20 | BCX-2000-S | 2" U x S | 9-3/8" | White | 12 | 28.0 | 41BV | |
| 2200C20TU | | 2" U x U | 12-3/8" | Clear | 12 | 37.0 | 41BV | |
| 2200-20UC | | 2" UC x UC | 12-5/16" | White | 12 | 35.8 | 41BV | |
| 2200-20TU | | 2" U x U | 12-3/8" | White | 12 | 37.0 | 41BV | |

POOL DIVERter VALVE

CPVC Three-Way Diverter Valve



PVC Single Union Serviceable



PVC Single Union Serviceable



| Part No. | IPS Size & Connection | Body Length | Color | Pkg. Qty. | Case (lbs.) | Product Class | Specifications |
|-------------------------------|--|-------------|-------|-----------|-------------|---------------|---|
| CPVC Three-Way Diverter Valve | | | | | | | |
| 1930-15 | 1-1/2" | 7" | Tan | 1 | 2.2 | 41PV | Rated @ 125 PSI Static Pressure @ 160°F |
| 1930-20 | 2" S x 2-1/2" Spg | 7" | Tan | 1 | 2.4 | 41PV | |
| PVC Single Union Serviceable | | | | | | | |
| 1351-15 | 1-1/2" FPT x FPT | 5-1/8" | White | 12 | 13.6 | 41BV | Rated @ 150 PSI Static Pressure @ 72°F |
| 1351-20 | 2" FPT x FPT | 6" | White | 6 | 10.9 | 41BV | |
| PVC Single Union Serviceable | | | | | | | |
| WSU-1520-S | 1-1/2" + 2" x 1-1/2" + 2" IPS HUB and SPIGOT | 5" | White | 8 | 7.8 | 42LT | Rated @ 150 PSI Static Pressure @ 72°F |

MIP (MOLDED-IN-PLACE) BALL VALVES *(Rated @ 150 PSI Static Pressure @ 72°F)*

MIP Non-Serviceable WHITE 1/2" - 2"



MIP Non-Serviceable WHITE 2-1/2" - 4"



MIP Non-Serviceable (NSF) WHITE 1/2" - 2"



MIP Non-Serviceable (NSF) WHITE 2-1/2" - 4"



| Part No. | IPS Size & Connection | Body Length | Color | Pkg. Qty. | Case (lbs.) | Product Class |
|---------------------------------|-----------------------|-------------|-------|-----------|-------------|---------------|
| MIP Non-Serviceable WHITE | | | | | | |
| E1310-05 | 1/2" S x S | 3-1/4" | White | 36 | 6.4 | 41MV |
| E1310-07 | 3/4" S x S | 3-3/4" | White | 18 | 5.5 | 41MV |
| E1310-10 | 1" S x S | 4-1/4" | White | 25 | 11.0 | 41MV |
| E1310-12 | 1-1/4" S x S | 4-1/2" | White | 12 | 9.4 | 41MV |
| E1310-15 | 1-1/2" S x S | 5-1/4" | White | 12 | 10.0 | 41MV |
| E1310-20 | 2" S x S | 5-3/4" | White | 6 | 7.9 | 41MV |
| E1310-25 | 2-1/2" S x S | 7" | White | 6 | 19.3 | 41MV |
| E1310-30 | 3" S x S | 8-1/2" | White | 2 | 8.8 | 41MV |
| E1310-40 | 4" S x S | 11-1/2" | White | 1 | 10.0 | 41MV |
| E1310-60 | 6" S x S | 16" | White | 1 | 22.3 | 41MV |
| MIP Non-Serviceable (NSF) WHITE | | | | | | |
| E1410-05 | 1/2" NSF S x S | 3-1/4" | White | 36 | 6.5 | 41MV |
| E1410-07 | 3/4" NSF S x S | 3-3/4" | White | 18 | 5.9 | 41MV |
| E1410-10 | 1" NSF S x S | 4-1/4" | White | 25 | 12.4 | 41MV |
| E1410-12 | 1-1/4" NSF S x S | 4-1/2" | White | 12 | 7.6 | 41MV |
| E1410-15 | 1-1/2" NSF S x S | 5-1/4" | White | 12 | 11.6 | 41MV |
| E1410-20 | 2" NSF S x S | 5-3/4" | White | 6 | 9.6 | 41MV |
| E1410-25 | 2-1/2" NSF S x S | 7" | White | 6 | 15 | 41MV |
| E1410-30 | 3" NSF S x S | 8-1/2" | White | 2 | 12.8 | 41MV |
| E1410-40 | 4" NSF S x S | 9" | White | 1 | 9.9 | 41MV |
| MIP Non-Serviceable (NSF) WHITE | | | | | | |
| E1420-05 | 1/2" NSF FPT x FPT | 3-1/4" | White | 36 | 6.7 | 41MV |
| E1420-07 | 3/4" NSF FPT x FPT | 3-1/4" | White | 18 | 6.1 | 41MV |
| E1420-10 | 1" NSF FPT x FPT | 4-1/4" | White | 25 | 13 | 41MV |
| E1420-12 | 1-1/4" NSF FPT x FPT | 4-1/4" | White | 12 | 8 | 41MV |
| E1420-15 | 1-1/2" NSF FPT x FPT | 5-1/2" | White | 12 | 12 | 41MV |
| E1420-20 | 2" NSF FPT x FPT | 5-3/4" | White | 6 | 10 | 41MV |
| E1420-25 | 2-1/2" NSF FPT x FPT | 7" | White | 6 | 15.5 | 41MV |
| E1420-30 | 3" NSF FPT x FPT | 8-1/2" | White | 2 | 13.5 | 41MV |
| E1420-40 | 4" NSF FPT x FPT | 9" | White | 1 | 10.8 | 41MV |

MIP (MOLDED-IN-PLACE) BALL VALVES (Rated @ 150 PSI Static Pressure @ 72°F)

MIP
Non-Serviceable
GRAY



| Part No. | IPS Size & Connection | Body Length | Color | Pkg. Qty. | Case (lbs.) | Product Class |
|---------------------------------|-----------------------|-------------|-------|-----------|-------------|---------------|
| MIP Non-Serviceable GRAY | | | | | | |
| E1610-05 | 1/2" S x S | 3-1/4" | Gray | 36 | 6.4 | 41MV |
| E1610-07 | 3/4" S x S | 3-3/4" | Gray | 18 | 5.5 | 41MV |
| E1610-10 | 1" S x S | 4-1/4" | Gray | 25 | 11.0 | 41MV |
| E1610-12 | 1-1/4" S x S | 4-1/2" | Gray | 12 | 9.4 | 41MV |
| E1610-15 | 1-1/2" S x S | 5-1/4" | Gray | 12 | 10.0 | 41MV |
| E1610-20 | 2" S x S | 5-3/4" | Gray | 6 | 7.9 | 41MV |
| E1610-60 | 6" S x S | 16" | Gray | 1 | 22.3 | 41MV |
| E1620-05 | 1/2" FPT x FPT | 3-1/4" | Gray | 36 | 6.4 | 41MV |
| E1620-07 | 3/4" FPT x FPT | 3-1/4" | Gray | 18 | 5.5 | 41MV |
| E1620-10 | 1" FPT x FPT | 4-1/4" | Gray | 25 | 11.0 | 41MV |
| E1620-12 | 1-1/4" FPT x FPT | 4-1/4" | Gray | 12 | 9.4 | 41MV |
| E1620-15 | 1-1/2" FPT x FPT | 5-1/2" | Gray | 12 | 10.0 | 41MV |
| E1620-20 | 2" FPT x FPT | 5-3/4" | Gray | 6 | 7.9 | 41MV |

TRUE UNION BALL VALVES

PVC Sch. 80
True Union
Serviceable



| Part No. | IPS Size & Connection | Body Length | Pkg. Qty. | Case (lbs.) | Product Class | Specifications |
|---|--------------------------------------|-------------|-----------|-------------|---------------|--|
| PVC Sch. 80 True Union Serviceable | | | | | | |
| BTU-0500-E | 1/2" EPDM Slip & Threaded | 4" | 18 | 8.2 | 42BV | Connection in both slip & threaded included Rated @ 150 PSI Static Pressure @ 72°F |
| BTU-0500-V | 1/2" VITON Slip & Threaded | 4" | 18 | 8.2 | 42BV | |
| BTU-0750-E | 3/4" EPDM Slip & Threaded | 4-3/4" | 10 | 7.5 | 42BV | |
| BTU-0750-V | 3/4" VITON Slip & Threaded | 4-3/4" | 10 | 7.5 | 42BV | |
| BTU-1000-E | 1" EPDM Slip & Threaded | 5-1/4" | 8 | 8.6 | 42BV | |
| BTU-1000-V | 1" VITON Slip & Threaded | 5-1/4" | 8 | 8.6 | 42BV | |
| BTU-1250-E | 1-1/4" EPDM Slip & Threaded | 6" | 4 | 7.6 | 42BV | |
| BTU-1250-V | 1-1/4" VITON Slip & Threaded | 6" | 4 | 7.6 | 42BV | |
| BTU-1500-E | 1-1/2" EPDM Slip & Threaded | 6-1/4" | 4 | 7.8 | 42BV | |
| BTU-1500-V | 1-1/2" VITON Slip & Threaded | 6-1/4" | 4 | 7.8 | 42BV | |
| BTU-2000-E | 2" EPDM Slip & Threaded | 7" | 2 | 6.0 | 42BV | |
| BTU-2000-V | 2" VITON Slip & Threaded | 7" | 2 | 6.0 | 42BV | |
| BTU-2500-SE | 2-1/2" SLIP EPDM | 11" | 1 | 11.0 | 42BV | |
| BTU-2500-TE | 2-1/2" FPT EPDM | 11" | 1 | 11.0 | 42BV | |
| BTU-3000-SE | 3" SLIP EPDM | 11" | 1 | 11.4 | 42BV | |
| BTU-3000-TE | 3" FPT EPDM | 11" | 1 | 11.4 | 42BV | |
| BTU-3000-TV | 3" FPT with Viton O-Rings | 11" | 1 | 11.4 | 42BV | |
| BTU-4000-SE | 4" SLIP EPDM BLK TRUE UNION | 12-1/2" | 1 | 19.1 | 42BV | |
| BTU-4000-TE | 4" FPT EPDM BLK TRUE VALVE | 12-1/2" | 1 | 19.1 | 42BV | |
| PVC Sch. 80 True Union Handles | | | | | | |
| BTU-0500-HL | 1/2" Red Blocked True Union Handle | N/A | N/A | N/A | 96MC | |
| BTU-0750-HL | 3/4" Red Blocked True Union Handle | N/A | N/A | N/A | 96MC | |
| BTU-1000-HL | 1" Red Blocked True Union Handle | N/A | N/A | N/A | 96MC | |
| BTU-1250-HL | 1-1/4" Red Blocked True Union Handle | N/A | N/A | N/A | 96MC | |
| BTU-1500-HL | 1-1/2" Red Blocked True Union Handle | N/A | N/A | N/A | 96MC | |
| BTU-2000-HL | 2" Red Blocked True Union Handle | N/A | N/A | N/A | 96MC | |

PVC Sch. 80
True Union
Handles



PVC LO-TORQUE BALL VALVES (GRAY)

PVC Sch. 80
LO-TORQUE



| Part No. | IPS Size & Connection | Body Length | Pkg. Qty. | Case (lbs.) | Product Class | Specifications |
|-----------------------|----------------------------------|-------------|-----------|-------------|---------------|---|
| PVC Sch. 80 LO-TORQUE | | | | | | |
| LT-0500-S | 1/2" LO-TORQUE BALL VALVE SLIP | 3-1/2" | 36 | 8.2 | 42LT | Rated @ 150 PSI Static Pressure @ 72°F NSF/ANSI 61+732 (Except Viton) UPC |
| LT-0500-T | 1/2" LO-TORQUE VALVE FPT | 3-1/2" | 36 | 8.2 | 42LT | |
| LT-0750-S | 3/4" LO-TORQUE BALL VALVE SLIP | 4" | 24 | 9.4 | 42LT | |
| LT-0750-T | 3/4" LO-TORQUE BALL VALVE FPT | 4" | 24 | 9.4 | 42LT | |
| LT-1000-S | 1" LO-TORQUE BALL VALVE SLIP | 4-1/2" | 18 | 10.0 | 42LT | |
| LT-1000-T | 1" LO-TORQUE BALL VALVE FPT | 4-1/2" | 18 | 10.0 | 42LT | |
| LT-1250-S | 1-1/4" LO-TORQUE BALL VALVE SLIP | 5-1/4" | 8 | 7.8 | 42LT | |
| LT-1250-SC | 1-1/4" GRAY CPVC BALL VALVE SLIP | 5-1/4" | 8 | 7.8 | 42LT | |
| LT-1250-T | 1-1/4" LO-TORQUE BALL VALVE FPT | 5-1/4" | 8 | 7.8 | 42LT | |
| LT-1500-S | 1-1/2" LO-TORQUE BALL VALVE SLIP | 5-3/4" | 6 | 7.3 | 42LT | |
| LT-1500-T | 1-1/2" LO-TORQUE BALL VALVE FPT | 5-3/4" | 6 | 7.3 | 42LT | |
| LT-2000-S | 2" LO-TORQUE BALL VALVE SLIP | 6-1/2" | 4 | 7.8 | 42LT | |
| LT-2000-T | 2" LO-TORQUE BALL VALVE FPT | 6-1/2" | 4 | 7.8 | 42LT | |

LO-TORQUE BALL VALVES (WHITE)

PVC Sch. 40
LO-TORQ

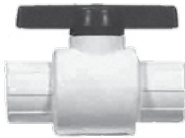

| Part No. | IPS Size & Connection | Body Length | Pkg. Qty. | Case (lbs.) | Product Class | Specifications |
|---------------------|-------------------------------------|-------------|-----------|-------------|---------------|--|
| PVC Sch. 40 LO-TORQ | | | | | | |
| WLT-0500-S | 1/2" Sch. 40 LO-TORQUE VALVE/SLIP | 3-1/2" | 36 | 8.2 | 42LT | PVC Rated @ 150 PSI Static Pressure @ 72°F NSF/ANSI 61+372 UPC |
| WLT-0500-T | 1/2" Sch. 40 LO-TORQUE VALVE/FPT | 3-1/2" | 36 | 8.2 | 42LT | |
| WLT-0750-S | 3/4" Sch. 40 LO-TORQUE VALVE/SLIP | 4" | 24 | 9.4 | 42LT | |
| WLT-0750-T | 3/4" Sch. 40 LO-TORQUE VALVE/FPT | 4" | 24 | 9.4 | 42LT | |
| WLT-1000-S | 1" Sch. 40 LO-TORQUE VALVE/SLIP | 4-1/2" | 18 | 10.0 | 42LT | |
| WLT-1000-T | 1" Sch. 40 LO-TORQUE VALVE/FPT | 4-1/2" | 18 | 10.0 | 42LT | |
| WLT-1250-S | 1-1/4" Sch. 40 LO-TORQUE VALVE/SLIP | 5-1/4" | 8 | 7.8 | 42LT | |
| WLT-1250-T | 1-1/4" Sch. 40 LO-TORQUE VALVE/FPT | 5-1/4" | 8 | 7.8 | 42LT | |
| WLT-1500-S | 1-1/2" LO-TORQUE BALL VALVE/SLIP | 5-3/4" | 6 | 7.3 | 42LT | |
| WLT-1500-T | 1-1/2" LO-TORQUE BALL VALVE/FPT | 5-3/4" | 6 | 7.3 | 42LT | |
| WLT-2000-S | 2" SCH. 40 LO-TORQUE VALVE/SLIP | 6-1/2" | 4 | 7.8 | 42LT | |
| WLT-2000-T | 2" SCH. 40 LO-TORQUE VALVE/FPT | 6-1/2" | 4 | 7.8 | 42LT | |

CPVC CTS BALL VALVES

CPVC CTS
Ball Valve
TAN



| Part No. | IPS Size & Connection | Body Length | Pkg. Qty. | Case (lbs.) | Product Class | Specifications |
|-------------------------|-----------------------|-------------|-----------|-------------|---------------|----------------|
| CPVC CTS Ball Valve TAN | | | | | | |
| C1310-05 | 1/2" CTS S x S | 3-1/4" | 25 | 6.0 | 41MV | |
| C1310-07 | 3/4" CTS S x S | 4" | 25 | 7.0 | 41MV | |
| C1310-10 | 1" CTS S x S | 4-1/4" | 25 | 11.0 | 41MV | |
| C1310-12 | 1-1/4" CTS S x S | 4-1/2" | 25 | 14.0 | 41MV | |
| C1310-15 | 1-1/2" CTS S x S | 5-1/2" | 25 | 14.0 | 41MV | |
| C1310-20 | 2" CTS S x S | 6" | 15 | 18.0 | 41MV | |

GATE VALVES

PVC Sch. 40
Gate Valve
WHITE









PVC Sch. 80
Gate Valve
GRAY



FLOW MANAGEMENT

| Part No. | IPS Size & Connection | Body Length | Pkg. Qty. | Case (lbs.) | Product Class | Specifications | |
|------------------------------|----------------------------------|-------------|-----------|-------------|---------------|---|---|
| PVC Sch. 40 Gate Valve WHITE | | | | | | | |
| GVP-0500-S | 1/2" PVC SLIP Gate Valve | 4-1/2" | 24 | 8.2 | 42GV | PVC Rated @ 150 PSI Static Pressure @ 72°F NSF/ANSI 61+372 (Except Viton) UPC (Slip Only) | |
| GVP-0500-T | 1/2" PVC FPT Gate Valve | 4-1/2" | 24 | 8.2 | 42GV | | |
| GVP-0750-S | 3/4" PVC Slip Gate Valve | 5" | 20 | 8.0 | 42GV | | |
| GVP-0750-T | 3/4" PVC FPT Gate Valve | 5" | 20 | 8.0 | 42GV | | |
| GVP-1000-S | 1" PVC Slip Gate Valve | 5-1/4" | 16 | 8.2 | 42GV | | |
| GVP-1000-T | 1" PVC FPT Gate Valve | 5-1/4" | 16 | 8.2 | 42GV | | |
| GVP-1250-S | 1-1/4" PVC Slip Gate Valve | 7-1/2" | 8 | 8.2 | 42GV | | |
| GVP-1250-T | 1-1/4" PVC FPT Gate Valve | 7-1/2" | 8 | 8.2 | 42GV | | |
| GVP-1500-S | 1-1/2" PVC Slip Gate Valve | 7-1/2" | 6 | 6.7 | 42GV | | |
| GVP-1500-T | 1-1/2" PVC FPT Gate Valve | 7-1/2" | 6 | 6.7 | 42GV | | |
| GVP-2000-S | 2" PVC Slip Gate Valve | 8-3/4" | 4 | 7.6 | 42GV | | |
| GVP-2000-T | 2" PVC FPT Gate Valve | 8-3/4" | 4 | 7.6 | 42GV | | |
| PVC Sch. 80 Gate Valve GRAY | | | | | | | |
| GVG-0500-S | 1/2" PVC Slip Gate Valve | 4-1/2" | 24 | 8.2 | 42GV | | PVC Rated @ 150 PSI Static Pressure @ 72°F NSF/ANSI 61+372 (Except Viton) UPC (Slip Only) |
| GVG-0500-SV | 1/2" Slip PVC Gate Valve Viton | 4-1/2" | 24 | 8.2 | 42GV | | |
| GVG-0500-T | 1/2" PVC FPT Gate Valve | 4-1/2" | 24 | 8.2 | 42GV | | |
| GVG-0500-TV | 1/2" FPT Gate Valve Viton | 4-1/2" | 24 | 8.2 | 42GV | | |
| GVG-0750-S | 3/4" PVC Slip Gate Valve | 5" | 20 | 8.0 | 42GV | | |
| GVG-0750-SV | 3/4" Slip PVC Gate Valve Viton | 5" | 20 | 8.0 | 42GV | | |
| GVG-0750-T | 3/4" PVC FPT Gate Valve | 5" | 20 | 8.0 | 42GV | | |
| GVG-1000-S | 1" PVC Slip Gate Valve | 5-1/4" | 16 | 8.2 | 42GV | | |
| GVG-1000-SV | 1" Slip PVC Gate Valve Viton | 5-1/4" | 16 | 8.2 | 42GV | | |
| GVG-1000-T | 1" FPT Gate Valve | 5-1/4" | 16 | 8.2 | 42GV | | |
| GVG-1000-TV | 1" FPT Gate Valve Viton | 5-1/4" | 16 | 8.2 | 42GV | | |
| GVG-1250-S | 1-1/4" PVC Slip Gate Valve | 7-1/2" | 8 | 8.2 | 42GV | | |
| GVG-1250-SV | 1-1/4" PVC Slip Gate Valve Viton | 7-1/2" | 8 | 8.2 | 42GV | | |
| GVG-1250-T | 1-1/4" PVC FPT Gate Valve | 7-1/2" | 8 | 8.2 | 42GV | | |
| GVG-1250-TV | 1-1/4" FPT Gate Valve Viton | 7-1/2" | 8 | 8.2 | 42GV | | |
| GVG-1500-S | 1-1/2" PVC Slip Gate Valve | 7-1/2" | 6 | 6.7 | 42GV | | |
| GVG-1500-SV | 1-1/2" Slip PVC Gate Valve Viton | 7-1/2" | 6 | 6.7 | 42GV | | |
| GVG-1500-T | 1-1/2" PVC FPT Gate Valve | 7-1/2" | 6 | 6.7 | 42GV | | |
| GVG-1500-TV | 1-1/2" FPT Gate Valve Viton | 7-1/2" | 6 | 6.7 | 42GV | | |
| GVG-2000-S | 2" PVC Slip Gate Valve | 8-3/4" | 4 | 7.6 | 42GV | | |
| GVG-2000-SV | 2" PVC Gate Valve Viton | 8-3/4" | 4 | 7.6 | 42GV | | |
| GVG-2000-T | 2" PVC FPT Gate Valve | 8-3/4" | 4 | 7.6 | 42GV | | |
| GVG-2000-TV | 2" FPT Gate Valve Viton | 8-3/4" | 4 | 7.6 | 42GV | | |

PVC UNIONS SCH. 80

| | Part No. | IPS Size & Connection | Body Length | Color | Pkg. Qty. | Case (lbs.) | Product Class | Specifications |
|---|--|-----------------------------------|-------------|-------|-----------|-------------|---------------|----------------|
|  <p>Sch. 80 Union SLIP x SLIP</p> | Sch. 80 Union SLIP x SLIP | | | | | | | |
| | U-0500-S | 1/2" PVC Sch. 80 Union Slip | 2" | Gray | 48 | 5.8 | 42UN | |
| | U-0750-S | 3/4" PVC Sch. 80 Union Slip | 2-1/2" | Gray | 24 | 5.8 | 42UN | |
| | U-1000-S | 1" PVC Sch. 80 Union Slip | 2-3/4" | Gray | 18 | 5.5 | 42UN | |
| | U-1250-S | 1-1/4" PVC Sch. 80 Union Slip | 3-1/4" | Gray | 12 | 5.8 | 42UN | |
| | U-1500-S | 1-1/2" PVC Sch. 80 Union Slip | 3-3/4" | Gray | 12 | 8.2 | 42UN | |
| | U-2000-S | 2" PVC Sch. 80 Union Slip | 4" | Gray | 6 | 6.1 | 42UN | |
| | U-2500-S | 2-1/2" Gray PVC Union Slip | 5" | Gray | 4 | 6.8 | 42UN | |
| | U-3000-S | 3" Gray PVC Union Slip | 6" | Gray | 2 | 5.0 | 42UN | |
| | U-4000-S | 4" Gray PVC Union Slip | 7-1/4" | Gray | 2 | 7.6 | 42UN | |
|  <p>Sch. 80 Union FPT x FPT</p> | Sch. 80 Union FPT x FPT | | | | | | | |
| | U-0500-T | 1/2" PVC Sch. 80 Union/Threaded | 2" | Gray | 48 | 5.8 | 42UN | |
| | U-0750-T | 3/4" PVC Sch. 80 Union/Threaded | 2-1/2" | Gray | 24 | 5.8 | 42UN | |
| | U-1000-T | 1" PVC Sch. 80 Union/Threaded | 2-3/4" | Gray | 18 | 5.5 | 42UN | |
| | U-1250-T | 1-1/4" PVC Sch. 80 Union/Threaded | 3-1/4" | Gray | 12 | 5.8 | 42UN | |
| | U-1500-T | 1-1/2" PVC Sch. 80 Union/Threaded | 3-3/4" | Gray | 12 | 8.2 | 42UN | |
| | U-2000-T | 2" PVC Sch. 80 Union/Threaded | 4" | Gray | 6 | 6.1 | 42UN | |
| | U-2500-T | 2-1/2" Gray PVC Threaded Union | 5" | Gray | 4 | 6.8 | 42UN | |
| | U-3000-T | 3" Gray PVC Threaded Union | 6" | Gray | 2 | 5.0 | 42UN | |
| | U-4000-T | 4" Gray PVC Threaded Union | 7-1/4" | Gray | 2 | 7.6 | 42UN | |
|  <p>Sch. 80 Union SLIP x MPT</p> | Sch. 80 Union SLIP x MPT | | | | | | | |
| | U-0500-SM | 1/2" Sch. 80 Union SLIP x MIPT | 3" | Gray | 48 | 8.2 | 42UN | |
| | U-0750-SM | 3/4" Sch. 80 Union SLIP x MIPT | 3-1/2" | Gray | 24 | 8.2 | 42UN | |
| | U-1000-SM | 1" Sch. 80 Union SLIP x MIPT | 4" | Gray | 18 | 8.2 | 42UN | |
| | U-1250-SM | 1-1/4" Sch. 80 Union SLIP x MIPT | 4-1/2" | Gray | 12 | 7.0 | 42UN | |
| | U-1500-SM | 1-1/2" Sch. 80 Union SLIP x MIPT | 6-3/4" | Gray | 8 | 6.6 | 42UN | |
|  <p>Sch. 80 Union SLIP x FPT</p> | Sch. 80 Union SLIP x FPT | | | | | | | |
| | U-0500-ST | 1/2" Sch. 80 Union SLIP x FIPT | 2" | Gray | 48 | 4.8 | 42UN | |
| | U-0750-ST | 3/4" Sch. 80 Union SLIP x FIPT | 2-1/2" | Gray | 24 | 4.8 | 42UN | |
| | U-1000-ST | 1" Sch. 80 Union SLIP x FIPT | 2-3/4" | Gray | 18 | 4.5 | 42UN | |
| | U-1500-ST | 1-1/2" Sch. 80 Union SLIP x FIPT | 3-3/4" | Gray | 8 | 4.8 | 42UN | |
| | U-2000-ST | 2" Sch. 80 Union SLIP x FIPT | 4" | Gray | 6 | 5.1 | 42UN | |
|  <p>Sch. 80 Union FPT x MPT</p> | Sch. 80 Union FPT x MPT | | | | | | | |
| | U-0500-TM | 1/2" Sch. 80 Union FIPT x MIPT | 3" | Gray | 48 | 8.2 | 42UN | |
| | U-0750-TM | 3/4" Sch. 80 Union FIPT x MIPT | 3-1/2" | Gray | 24 | 8.2 | 42UN | |
| | U-1000-TM | 1" Sch. 80 Union FIPT x MIPT | 4" | Gray | 18 | 8.2 | 42UN | |
| | U-1500-TM | 1-1/2" Sch. 80 Union FIPT x MIPT | 4-3/4" | Gray | 8 | 6.6 | 42UN | |
| | U-2000-TM | 2" Sch. 80 Union FIPT x MIPT | 5" | Gray | 6 | 7.6 | 42UN | |
|  <p>Sch. 80 Union SLIP x SLIP Viton O-Ring</p> | Sch. 80 Union SLIP x SLIP Viton O-Ring | | | | | | | |
| | U-0500-SV | 1/2" Sch. 80 SLIP Viton Union | 2" | Gray | 48 | 5.8 | 42UN | |
| | U-0750-SV | 3/4" Sch. 80 SLIP Viton Union | 2-1/2" | Gray | 24 | 5.8 | 42UN | |
| | U-1000-SV | 1" Sch. 80 SLIP Viton Union | 2-3/4" | Gray | 18 | 5.5 | 42UN | |
| | U-1250-SV | 1-1/4" Sch. 80 SLIP Viton Union | 3-1/4" | Gray | 12 | 5.8 | 42UN | |
| | U-1500-SV | 1-1/2" Sch. 80 SLIP Viton Union | 3-3/4" | Gray | 12 | 8.2 | 42UN | |
| | U-2000-SV | 2" Sch. 80 SLIP Viton Union | 4" | Gray | 6 | 6.1 | 42UN | |
| | U-2500-SV | 2-1/2" Gray Union Slip - Viton | 5" | Gray | 4 | 6.8 | 42UN | |
| | U-3000-SV | 3" Gray PVC Union Slip - Viton | 6" | Gray | 2 | 5.0 | 42UN | |
| | U-4000-SV | 4" Gray PVC Union Slip - Viton | 7-1/4" | Gray | 2 | 7.6 | 42UN | |
|  <p>Sch. 80 Union FPT x FPT Viton O-Ring</p> | Sch. 80 Union FPT x FPT Viton O-Ring | | | | | | | |
| | U-1000-TV | 1" Sch. 80 THRD Viton Union | 2-3/4" | Gray | 18 | 5.5 | 42UN | |
| | U-1250-TV | 1-1/4" Sch. 80 THRD Viton Union | 3-1/4" | Gray | 12 | 5.8 | 42UN | |
| | U-1500-TV | 1-1/2" Sch. 80 THRD Viton Union | 3-3/4" | Gray | 12 | 8.2 | 42UN | |
| | U-2000-TV | 2" Sch. 80 THRD Viton Union | 4" | Gray | 6 | 6.1 | 42UN | |
| | U-2500-TV | 2-1/2" Gray Union THRD - Viton | 5" | Gray | 4 | 6.8 | 42UN | |
| | U-3000-TV | 3" Gray Union THRD - Viton | 6" | Gray | 2 | 5.0 | 42UN | |
| | U-4000-TV | 4" Gray Union THRD - Viton | 7-1/4" | Gray | 2 | 7.6 | 42UN | |

PVC
Rated
@ 150 PSI @
72°F
NSF/ANSI
61+372
(Except Viton)
UPC (1/2-2"
Slip Only)

FLOW MANAGEMENT

PVC UNIONS SCH. 40

Sch. 40 Union
SLIP x SLIP



| Part No. | Description | Body Length | Color | Pkg. Qty. | Case (lbs.) | Product Class | Specifications |
|---------------------------|-------------------------------|-------------|-------|-----------|-------------|---------------|---|
| Sch. 40 Union SLIP x SLIP | | | | | | | |
| WU-0500-S | 1/2" PVC SCH. 40 Union Slip | 2" | White | 48 | 5.8 | 42UN | PVC Rated @ 150 PSI @ 72°F NSF/ANSI 61+372 UPC (Slip Only) |
| WU-0750-S | 3/4" PVC SCH. 40 Union Slip | 2-1/2" | White | 24 | 5.8 | 42UN | |
| WU-1000-S | 1" PVC SCH. 40 Union Slip | 2-3/4" | White | 18 | 5.5 | 42UN | |
| WU-1250-S | 1-1/4" PVC SCH. 40 Union Slip | 3-1/4" | White | 12 | 5.8 | 42UN | |
| WU-1500-S | 1-1/2" PVC SCH. 40 Union Slip | 3-3/4" | White | 12 | 8.2 | 42UN | |
| WU-2000-S | 2" PVC SCH. 40 Union Slip | 4" | White | 6 | 6.1 | 42UN | |
| WU-3000-S | 3" PVC SCH. 40 Union Slip | 6" | White | 2 | 5.0 | 42UN | |
| WU-4000-S | 4" PVC SCH. 40 Union Slip | 7-1/4" | White | 2 | 6.1 | 42UN | |
| Sch. 40 Union FPT x FPT | | | | | | | |
| WU-0500-T | 1/2" PVC SCH. 40 Union FPT | 2" | White | 48 | 5.8 | 42UN | |
| WU-0750-T | 3/4" PVC SCH. 40 Union FPT | 2-1/2" | White | 24 | 5.8 | 42UN | |
| WU-1000-T | 1" PVC SCH. 40 Union FPT | 2-3/4" | White | 18 | 5.5 | 42UN | |
| WU-1250-T | 1-1/4" PVC SCH. 40 Union FPT | 3-1/4" | White | 12 | 5.8 | 42UN | |
| WU-1500-T | 1-1/2" PVC SCH. 40 Union FPT | 3-3/4" | White | 12 | 8.2 | 42UN | |
| WU-2000-T | 2" PVC SCH. 40 Union FPT | 4" | White | 6 | 6.1 | 42UN | |

Sch. 40 Union
FPT x FPT



FIRE HYDRANT CAP & SEWER CLEANOUT

Cap



Cleanout



| Part No. | IPS Size | Body Length | Color | Pkg. Qty. | Case (lbs.) | Product Class |
|----------|-----------------------|-------------|-------|-----------|-------------|---------------|
| Cap | | | | | | |
| 23-25T | 2-1/2" FPT x 3/4" FPT | 4-3/4" | Gray | 15 | 7.0 | 41UN |
| Cleanout | | | | | | |
| 22-040 | 4" SEWER CLEANOUT | 9-1/4" | Black | 6 | 9.1 | 41UN |

SADDLES

Flo-Tap™ Hot/Wet Taps for PVC Pipe (Rated @ 200 PSI Static Pressure @ 72°F)

For PVC Pipes
3/4" and 1"
Service Lines



For PVC Pipes
1-1/2" and 2"
Service Lines



| Part No. | Pipe Size | Branch Size & Connection | Color | Pkg. Qty. | Case (lbs.) | Product Class | Specifications |
|---|-----------|--------------------------|-------|-----------|-------------|---------------|--|
| For PVC Pipes 3/4" and 1" Service Lines | | | | | | | |
| 3115 | 1-1/2" | 3/4" S x 1" SPG | Gray | 5 | 5.5 | 41FS | For PVC Pipe Pressure Rated @ 200 PSI @ 72°F NSF/ANSI 61+372 PVC Type II |
| 3120 | 2" | 3/4" S x 1" SPG | Gray | 5 | 6.0 | 41FS | |
| 3125 | 2-1/2" | 3/4" S x 1" SPG | Gray | 5 | 6.0 | 41FS | |
| 3130 | 3" | 3/4" S x 1" SPG | Gray | 5 | 11.0 | 41FS | |
| 3140 | 4" | 3/4" S x 1" SPG | Gray | 5 | 11.0 | 41FS | |
| 3160 | 6" | 3/4" S x 1" SPG | Gray | 5 | 13.0 | 41FS | |
| For PVC Pipes 1-1/2" and 2" Service Lines | | | | | | | |
| 3220 | 2" | 1-1/2" S x 2" SPG | Gray | 5 | 9.5 | 41FS | |
| 3225 | 2-1/2" | 1-1/2" S x 2" SPG | Gray | 5 | 9.5 | 41FS | |
| 3230 | 3" | 1-1/2" S x 2" SPG | Gray | 5 | 15.0 | 41FS | |
| 3240 | 4" | 1-1/2" S x 2" SPG | Gray | 5 | 14.0 | 41FS | |
| 3260 | 6" | 1-1/2" S x 2" SPG | Gray | 5 | 20.0 | 41FS | |
| 3280 | 8" | 1-1/2" S x 2" SPG | Gray | 5 | 25.0 | 41FS | |

RIGID CLAMP-IT™ SADDLES

For Poly Pipe IPS
Pipe Sizes –
PVC-IPS Fixed
Outlet



For PVC IPS
Pipe Sizes –
PVC-IPS Fixed
Outlet



| Part No. | IPS Pipe Size | IPS Tap Size & Connection | Color | Pkg. Qty. | Case (lbs.) | Product Class | Specifications |
|---|---------------|---------------------------|-------|-----------|-------------|---------------|--|
| For Poly Pipe IPS Pipe Sizes – PVC-IPS Fixed Outlet | | | | | | | |
| 321507P | 1-1/2" | 3/4" FPT | Gray | 25 | 9.0 | 41FS | For polyethylene tubing main line Pressure Rated @ 125 PSI @ 72°F NSF/ANSI 61 +372 PVC Type II |
| 321510P | 1-1/2" | 1" FPT | Gray | 25 | 9.0 | 41FS | |
| 331510P | 1-1/2" | 1" S | Gray | 25 | 9.0 | 41FS | |
| 322010P | 2" | 1" FPT | Gray | 25 | 9.0 | 41FS | |
| 332007P | 2" | 3/4" S | Gray | 25 | 9.0 | 41FS | |
| 332010P | 2" | 1" S | Gray | 25 | 9.0 | 41FS | |
| 353010P | 3" | 1" S | Gray | 15 | 10.0 | 41FS | |
| 344007P | 4" | 3/4" FPT | Gray | 15 | 8.0 | 41FS | |
| For PVC IPS Pipe Sizes – PVC-IPS Fixed Outlet | | | | | | | |
| 421507 | 1-1/2" | 3/4" FPT | Gray | 5 | 4.0 | 41FS | For PVC pipe main line Pressure Rated @ 200 PSI @ 72°F NSF/ANSI 61 +372 PVC Type II |
| 421510 | 1-1/2" | 1" FPT | Gray | 5 | 4.5 | 41FS | |
| 422007 | 2" | 3/4" FPT | Gray | 5 | 4.5 | 41FS | |
| 422010 | 2" | 1" FPT | Gray | 5 | 4.5 | 41FS | |
| 422012 | 2" | 1-1/4" FPT | Gray | 5 | 5.0 | 41FS | |
| 422015 | 2" | 1-1/2" FPT | Gray | 5 | 5.0 | 41FS | |
| 432007 | 2" | 3/4" S | Gray | 5 | 4.5 | 41FS | |
| 432010 | 2" | 1" S | Gray | 5 | 4.5 | 41FS | |
| 432012 | 2" | 1-1/4" S | Gray | 5 | 4.5 | 41FS | |
| 432015 | 2" | 1-1/2" S | Gray | 5 | 5.0 | 41FS | |
| 422507 | 2-1/2" | 3/4" FPT | Gray | 5 | 5.0 | 41FS | |
| 422510 | 2-1/2" | 1" FPT | Gray | 5 | 5.0 | 41FS | |
| 422515 | 2-1/2" | 1-1/2" FPT | Gray | 5 | 5.0 | 41FS | |
| 422520 | 2-1/2" | 2" FPT | Gray | 5 | 5.0 | 41FS | |
| 432510 | 2-1/2" | 1" S | Gray | 5 | 5.0 | 41FS | |
| 432515 | 2-1/2" | 1-1/2" S | Gray | 5 | 5.0 | 41FS | |
| 432520 | 2-1/2" | 2" S | Gray | 5 | 5.0 | 41FS | |
| 443007 | 3" | 3/4" FPT | Gray | 5 | 8.0 | 41FS | |
| 443010 | 3" | 1" FPT | Gray | 5 | 8.0 | 41FS | |
| 443012 | 3" | 1-1/4" FPT | Gray | 5 | 8.5 | 41FS | |
| 443015 | 3" | 1-1/2" FPT | Gray | 5 | 8.5 | 41FS | |
| 443020 | 3" | 2" FPT | Gray | 5 | 8.5 | 41FS | |
| 453007 | 3" | 3/4" S | Gray | 5 | 8.0 | 41FS | |
| 453010 | 3" | 1" S | Gray | 5 | 8.0 | 41FS | |
| 453012 | 3" | 1-1/4" S | Gray | 5 | 8.0 | 41FS | |
| 453015 | 3" | 1-1/2" S | Gray | 5 | 8.5 | 41FS | |
| 453020 | 3" | 2" S | Gray | 5 | 8.5 | 41FS | |
| 444007 | 4" | 3/4" FPT | Gray | 5 | 9.5 | 41FS | |
| 444010 | 4" | 1" FPT | Gray | 5 | 9.5 | 41FS | |
| 444012 | 4" | 1-1/4" FPT | Gray | 5 | 10.0 | 41FS | |
| 444015 | 4" | 1-1/2" FPT | Gray | 5 | 10.0 | 41FS | |
| 444020 | 4" | 2" FPT | Gray | 5 | 10.0 | 41FS | |
| 454007 | 4" | 3/4" S | Gray | 5 | 9.5 | 41FS | |
| 454010 | 4" | 1" S | Gray | 5 | 9.5 | 41FS | |
| 454015 | 4" | 1-1/2" S | Gray | 5 | 9.5 | 41FS | |
| 454020 | 4" | 2" S | Gray | 5 | 9.5 | 41FS | |
| 446007 | 6" | 3/4" FPT | Gray | 5 | 12.0 | 41FS | |
| 446010 | 6" | 1" FPT | Gray | 5 | 12.0 | 41FS | |
| 446012 | 6" | 1-1/4" FPT | Gray | 5 | 12.0 | 41FS | |
| 446015 | 6" | 1-1/2" FPT | Gray | 5 | 12.5 | 41FS | |
| 446020 | 6" | 2" FPT | Gray | 5 | 12.5 | 41FS | |
| 456010 | 6" | 1" S | Gray | 5 | 11.5 | 41FS | |
| 456015 | 6" | 1-1/2" S | Gray | 5 | 12.0 | 41FS | |
| 456020 | 6" | 2" S | Gray | 5 | 12.0 | 41FS | |
| 448007 | 8" | 3/4" FPT | Gray | 5 | 17.0 | 41FS | |
| 448010 | 8" | 1" FPT | Gray | 5 | 17.0 | 41FS | |
| 448015 | 8" | 1-1/2" FPT | Gray | 5 | 17.0 | 41FS | |
| 448020 | 8" | 2" FPT | Gray | 5 | 17.0 | 41FS | |
| 458015 | 8" | 1-1/2" S | Gray | 5 | 17.0 | 41FS | |
| 458020 | 8" | 2" S | Gray | 5 | 17.0 | 41FS | |

SWING JOINTS



PVC Sch. 80
Swing Assembly
GRAY



PVC Sch. 40
Swing Assembly
WHITE

| Part No. | Description | Color | Pkg. Qty. | Product Class | Specifications |
|-----------------------------------|-------------------------------|-------|-----------|---------------|----------------------------------|
| PVC Sch. 80 Swing Assembly | | | | | |
| TSA-0500-BB | 1/2" (BSP x BSP) | Gray | 60 | 42TS | PVC Rated @ 315 PSI @ 72°F |
| TSA-0500-ST | 1/2" S x M | Gray | 60 | 42TS | |
| TSA-0500-TT | 1/2" M x M | Gray | 60 | 42TS | |
| TSA-0750-BB | 3/4" (BSP x BSP) | Gray | 50 | 42TS | |
| TSA-0750-CT | 3/4" SCKT x MIPT | Gray | 50 | 42TS | |
| TSA-0750-LT | 3/4" LONG SPGT/MIPT | Gray | 50 | 42TS | |
| TSA-0750-SC | 3/4" S x S | Gray | 50 | 42TS | |
| TSA-0750-ST | 3/4" S x M | Gray | 50 | 42TS | |
| TSA-0750-TT | 3/4" M X M | Gray | 50 | 42TS | |
| TSA-1000-BB | 1" (BSP x BSP) | Gray | 25 | 42TS | |
| TSA-1000-ST | 1" S x M | Gray | 25 | 42TS | |
| TSA-1000-TT | 1" M x M | Gray | 25 | 42TS | |
| TSA-1250-TT | 1-1/4" M x M | Gray | 15 | 42TS | |
| TSA-1500-SA | 1-1/2" S x ACME | Gray | 15 | 42TS | |
| TSA-1500-ST | 1-1/2" S x M | Gray | 15 | 42TS | |
| TSA-1500-TT | 1-1/2" M x M | Gray | 15 | 42TS | |
| TSA-1512-ST | 1-1/2" X 1-1/4" SPIGOT x MIPT | Gray | 15 | 42TS | |
| TSA-1512-TT | 1-1/2" X 1-1/4" (MIPT x MIPT) | Gray | 15 | 42TS | |
| PVC Sch. 40 Swing Assembly | | | | | |
| WSA-0500-TT | 1/2" (T x T) | White | 60 | 42TS | PVC Rated @ 315 PSI @ 72°F |
| WSA-0750-TT | 3/4" (T x T) | White | 50 | 42TS | |
| WSA-1000-TT | 1" (T x T) | White | 25 | 42TS | |
| WSA-1250-TT | 1-1/4" (T x T) | White | 25 | 42TS | |

ECONOMY SWING JOINTS



PVC/Poly Econo
Swing Joints

| Part No. | Description | Color | Pkg. Qty. | Product Class | Specifications |
|--------------------------------------|-------------------------------|-------|-----------|---------------|--------------------------|
| PVC/Poly Econo Swing Joints | | | | | |
| TSE-0500-6 | 1/2" x 6" MIPT x MIPT | Black | 100 | 42TS | Rated @ 70 PSI @ 72°F |
| TSE-0500-6R | 1/2" x 6" MIPT x MIPT | Black | 50 | 42TS | |
| TSE-0500-12 | 1/2" x 12" MIPT x MIPT | Black | 50 | 42TS | |
| TSE-0500-12R | 1/2" x 12" MIPT x MIPT | Black | 50 | 42TS | |
| TSE-0507-6 | 1/2" x 3/4" x 6" MIPT x MIPT | Black | 50 | 42TS | |
| TSE-0507-6R | 1/2" x 3/4" x 6" MIPT x MIPT | Black | 50 | 42TS | |
| TSE-0507-12 | 1/2" x 3/4" x 12" MIPT x MIPT | Black | 50 | 42TS | |
| TSE-0750-6 | 3/4" x 6" MIPT x MIPT | Black | 50 | 42TS | |
| TSE-0750-6R | 3/4" x 6" MIPT x MIPT | Black | 50 | 42TS | |
| TSE-0750-12 | 3/4" x 12" MIPT x MIPT | Black | 50 | 42TS | |
| TSE-0750-12R | 3/4" x 12" MIPT x MIPT | Black | 50 | 42TS | |
| "R" Indicates Additional Inlet Elbow | | | | | |

LANDSCAPE SPRINKLER PRODUCTS

| | Part No. | Description | Ctn. Qty. | Product Class | Specifications |
|------------------------|-------------------------------|--|-----------|---------------|-----------------------|
| | Cut-Off Risers | | | | |
| Cutoff Risers | FCO-0500 | 1/2" x 6" Flex Cut-Off | 50 | 42LS | Rated @ 70 PSI @ 72°F |
| | FCO-0750-R | 1/2" x 3/4" x 6" MIPT x MIPT Flex-Cutoff | 500 | 42LS | |
| | MCO-0500 | 1/2" x 6" MIPT x MIPT Multi-Cutoff | 500 | 42LS | |
| | MCO-0500-12 | 1/2" x 12" MIPT x MIPT Multi-Cutoff | 250 | 42LS | |
| | MCO-0750 | 3/4" x 6" MIPT x MIPT Multi-Cutoff | 500 | 42LS | |
| | MCO-0750-R | 1/2" x 3/4" x 6" MIPT x MIPT Multi-Cutoff | 500 | 42LS | |
| | Flex Risers | | | | |
| Flex Risers | FR-0500-4 | 1/2" x 4" MIPT x MIPT Flex Riser | 100 | 42LS | Rated @ 70 PSI @ 72°F |
| | FR-0500-4F | 1/2" x 4" MPT x FPT Flex Riser | 100 | 42LS | |
| | FR-0500-6 | 1/2" x 6" MIPT x MIPT Flex Riser | 100 | 42LS | |
| | FR-0500-6F | 1/2" x 6" MIPT x FIPT Flex Riser | 100 | 42LS | |
| | FR-0750-6 | 3/4" x 6" MIPT x MIPT Flex Riser | 50 | 42LS | |
| | FR-1000-7 | 1" x 7" MIPT x MIPT Flex Riser | 25 | 42LS | |
| | Cutoff Riser Extension | | | | |
| Cutoff Riser Extension | CRE-0500-3 | 1/2" x 3" FIPT x MIPT Cutoff Riser Extension | 200 | 42LS | Rated @ 70 PSI @ 72°F |
| | CRE-0750-4 | 3/4" x 4" FIPT x MIPT Cutoff Riser Extension | 200 | 42LS | |
| | Street Elbows | | | | |
| Street Elbows | STL-0500 | 1/2" 90° FIPT x MIPT Street Elbow | 1600 | 42LS | Rated @ 70 PSI @ 72°F |
| | STL-0750 | 3/4" 90° FIPT x MIPT Street Elbow | 1000 | 42LS | |
| | Swing Pipe Fittings | | | | |
| Swing Pipe Fittings | FPA-0500 | Swing Pipe Adapter .490BARB x 1/2" | 50 | 42LS | |
| | FPA-0750 | 3/4" Swing Pipe Adapter | 250 | 42LS | |
| | FPC-0490 | .49" Swing Pipe Connector | 250 | 42LS | |
| | FPE-0500 | 1/2" Swing Pipe Elbow | 400 | 42LS | |
| | FPE-0500F | 1/2" Swing Pipe Elbow FPT x Spiral Barb | 400 | 42LS | |
| | FPE-0750 | 3/4" Swing Pipe Elbow | 250 | 42LS | |
| | FPT-0500 | 1/2" Swing Pipe Tee | 500 | 42LS | |
| | Shrub Adapter | | | | |
| Shrub Adapter | SAM-0500 | 1/2" Male Sprinkler Adapter | 50 | 42LS | Rated @ 70 PSI @ 72°F |

FLOW MANAGEMENT

BACKWATER VALVES



See list of products on pages 178-179.

TECHNICAL DATA & INSTALLATION

Technical Data

NDS requires that the local and state plumbing codes be reviewed and understood prior to installing any of NDS Flow Management's products. These codes will provide proper installation procedures.

1. PVC Material Specification PVC Type I, Grade I, Cell Class 12454-B meeting requirements of ASTM D-1784-03 is used in the manufacturing of all fittings recommended for use of potable cold water (see chart C for temperature vs. pressure on page 165). Not recommended for use on systems exceeding 100 psi at 120 degrees F.

2. PVC Material Specification PVC Type II, Cell Class NSF14333 of ASTM D-1784 is used in manufacturing of fittings that require more chemical, heat, and impact resistance than PVC I.

3. CPVC Material Specification CPVC Type IV, Grade I, Cell Class 23447-B meeting requirements of ASTM D-1784-03 is used in the manufacturing of all fittings recommended for use on potable Hot Water Systems in accordance with ASTM D-2846-73. Not recommended for use on systems that will exceed 100 psi at 180 degrees F.

4. Buna-N Seals are in accordance with ASTM D-2000. It is generally resistant to many hydrocarbons, fats, oils, greases, hydraulic fluids and chemicals. It is generally attacked by Ozone, Ketones, Esters, Aldehydes, chlorinated and nitro hydrocarbons. Reference chemical resistance under NBR (Nitrile) Elastomers for specific listings.

5. EPDM O-Rings This o-ring material is made of high-quality EPDM (Ethylene Propylene Copolymer) which is in accordance with ASTM D-2000. EPDM has exceptionally good weather aging and ozone resistance, excellent water and chemical resistance, and excellent aging resistance for most applications. EPDM is a polymer where oil and solvent resistance is poor. However, it is fairly good in ketones and alcohols. Reference chemical resistance under EPDM, EPT, or EPR Elastomers for specific listings.

6. Viton O-Rings This o-ring material exhibits a broad range of chemical resistance: petroleum oils, silicone, grease, etc. We recommend you refer to a chemical resistance chart for specific applications. Maximum recommended service temperature is 400° F. Viton is a registered trademark of DuPont.

7. Double Seal of standard compression fitting. A compressive action is created as the cap is tightened squeezing the Buna-N seals into the tapered recessed areas of the cap and body. This process creates a highly concentrated pressure at the two "double seal" points, thus providing positive protection against leakage. (See Figure A on page 166)

8. Acme Thread General purpose 10 pitch and 5 pitch Acme thread on Compression Cap section eliminates the possibility of cross-threading. This smooth running design prevents binding or galling as is often experienced in standard tapered threads.

9. Springs Series 300 Stainless Steel.

TECHNICAL DATA & INSTALLATION

Information

UPC #6-70686-

TEMPERATURE VARIATION AND WORKING PRESSURE CHART

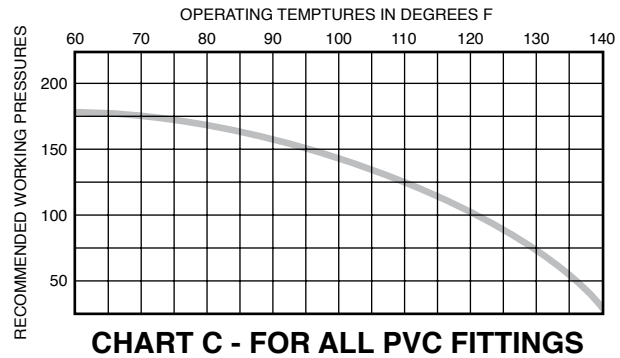

Important

Non-shock valves manufactured from PVC Type I material

WATER HAMMER – NDS requires that all PVC plastic piping systems be designed and constructed to **AVOID EXCESSIVE WATER HAMMER**. Water hammer can cause damage, and failure to pipe, valves, and fittings within the piping system. Not recommended in any shock applications.

NDS DOES NOT RECOMMEND the use of thermoplastic piping products for systems to transport or store compressed air or gases, or the testing of thermoplastic piping systems with compressed air or gases in above and below ground locations. The use of our product in exposed, compressed air or gas systems automatically voids our warranty for such products and its use against our recommendations is entirely the responsibility and liability of the installer. NDS will not accept responsibility for damage or impairment of its products, or other consequential or incidental damages caused by misapplication, incorrect assembly, and/or exposure to harmful substances or conditions. See warranty on inside back cover.

Check valves may be suitable for usage on grinder pump installations, provided the maximum recommended flow velocities through Flow Management plastic valves are not exceeded, the grinder pump system is inspected for proper usage, and on a preventative maintenance schedule. Note that excessive chemical contact and backpressure will cause the check valve gasket to deteriorate at a premature rate. Also, placing the check valve horizontal or at a 45° angle, instead of a vertical position, is recommended. Please follow local code guidelines.

Clamp-It™ / Flo-Tap™ Saddles

| CLAMP-IT SADDLE DRILL SIZES | |
|------------------------------|------------|
| OUTLET SIZE OVER 2-1/2" PIPE | DRILL SIZE |
| 3/4" IPS S & FPT | 3/4" |
| 1" IPS S & FPT | 1" |
| 1-1/4" IPS S & FPT | 1-1/4" |
| 1-1/2" IPS S & FPT | 1-3/8" |
| 2" IPS S & FPT | 2" |

For 2-1/2" IPS Saddle with a 2" outlet – Drill Size must be 1-1/2" due to pipe restriction

| FLO-TAP™ HOT/WET TAP SADDLES | |
|--|--|
| FOR 3/4" AND 1" | FOR 1-1/2" AND 2" |
| To drive cutter use a standard 3/8" ratchet with a 6" extension. TAP Cuts .750" hole. | To drive cutter use a standard 1/2" ratchet with a 6" extension. TAP Cuts 1.250" hole. |
| Captures Coupon – No pipe chips in water system. CAUTION: Do not tap any PVC pipes with wall thickness exceeding .540" (8" C – 900 SDR 18, CLASS 150). Refer to temperature variation and working pressure chart above for maximum pressure vs. maximum temperature. | |
| NOT FOR USE WITH COMPRESSED AIR OR NATURAL GAS LINES. | |

TECHNICAL DATA & INSTALLATION

Installation Instructions

NOTE: NDS does not recommend using an FPT (female) PVC fitting with an MPT (male) metal fitting; ASTM F1498. Unless the female PVC fitting is used with a metal reinforcement ring, it may expand beyond its strength around a metal fitting, which can result in cracks and leaks.

1. Compression Fittings

Compression cap should be drawn up hand-tight to insure proper alignment and seating of gasket, then tighten 3/4 to 1 turn with a Flo Spanner Wrench or strap wrench. Average torque should be approximately 25 foot-pounds on 1/2" through 2" IPS, and 35 foot-pounds on 2-1/2" and larger IPS. Compression fittings are not for use on compressed air lines or natural gas lines. When installing the Standard Compression Seal fittings the pipe line must be restrained from lateral movement by thorough soil compaction on straight runs and thrust blocking at change of direction or reduction in size. Not for use on pipe lines suspended on hangers.

2. Pipe Threads

Use teflon tape on all IPS thread connections. IPS thread connection should be made hand-tight plus 1/2 to 3/4 turn with a wrench.

3. Flo-Lock Adapters

For use on polyethylene tube (PE) with wall thickness of SDR-26, Class 160 or greater, PVC pipe, or copper tubing. Not recommended for use on galvanized pipe unless surface is sanded smooth. (See Figure B)

4. Solvent Welding

NDS requires that all parts that are to be solvent cemented are clean of any and all foreign materials. Solvent cement manufacturers include installation instructions on the container. It is important to follow correct cementing instructions to avoid problems. Excessive cement or the incorrect type of cement can cause failures in thermoplastic products.

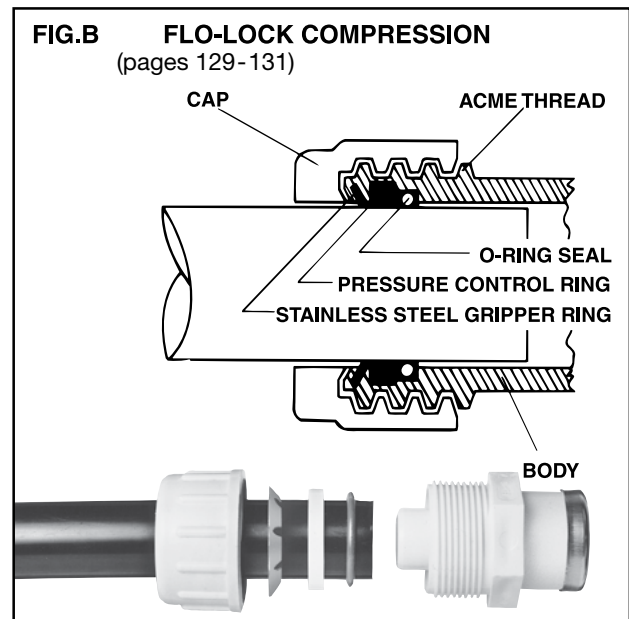
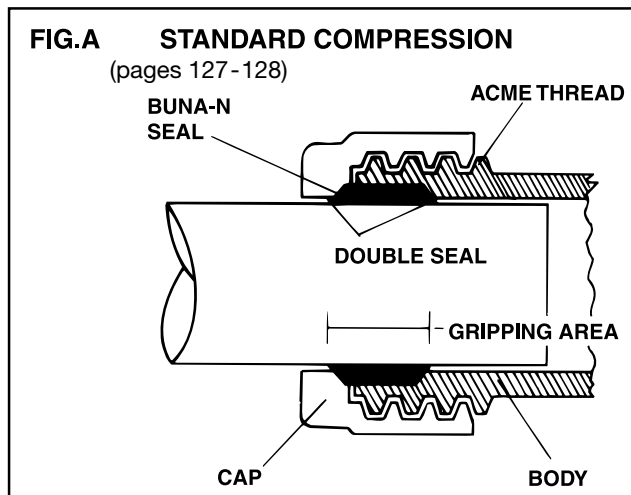

TECHNICAL DATA & INSTALLATION

Pipe Size Legend

| Abbreviation | Description |
|--------------|-------------------------------------|
| CTS | COPPER TUBE SIZE |
| IPS | IRON PIPE SIZE (SAME AS SCH. 40 OD) |
| DR | PE TUBING SIZE |
| PEP | PE PIPE (SIDR -7) |
| SDR | PE TUBING SIZE |
| SIDR | PE TUBING SIZE |
| TS | PE TUBE SIZE |

Connection Type Legend

| Abbreviation | Description |
|--------------|---|
| SPG | SPIGOT |
| MPT | MALE PIPE TAPER THREAD |
| FPT | FEMALE PIPE TAPER THREAD |
| S | SLIP |
| U | UNION FITTING WITH SLIP CONNECTION |
| U x U | TRUE UNION – SLIP CONNECTION WITH UNION ON EACH END |
| UC | UNION FITTING WITH COMPRESSION CONNECTION |
| UC x UC | UNION FITTING WITH COMPRESSION CONNECTION ON EACH END |
| FHT | FEMALE HOSE THREAD |
| MHT | MALE HOSE THREAD |

Pipe & Tube Dimensions

| ASTM | SIDR-7 | OD | ID | Wall |
|------------------------|------------------------|----------|-------|-------|
| D2239 | 3/4" | 1.060 | 0.824 | 0.118 |
| | 1" | 1.349 | 1.049 | 0.150 |
| | 1-1/4" | 1.774 | 1.380 | 0.197 |
| | 1-1/2" | 2.070 | 1.610 | 0.230 |
| | 2" | 2.657 | 2.067 | 0.295 |
| ASTM | SIDR-9 | OD | ID | Wall |
| D2239 | 3/4" | 1.008 | 0.824 | 0.092 |
| | 1" | 1.283 | 1.049 | 0.117 |
| | 1-1/4" | 1.686 | 1.380 | 0.153 |
| | 1-1/2" | 1.968 | 1.610 | 0.179 |
| | 2" | 2.527 | 2.067 | 0.230 |
| ASTM | SDR-9 | OD | ID | Wall |
| D2737 | 3/4" | 0.875 | 0.681 | 0.097 |
| | 1" | 1.125 | 0.875 | 0.125 |
| | 1-1/4" | 1.375 | 1.069 | 0.153 |
| | 1-1/2" | 1.625 | 1.263 | 0.181 |
| | 2" | 2.125 | 1.653 | 0.236 |
| ASTM | SDR-11 | OD | ID | Wall |
| D2737 | 3/4" | 0.875 | 0.715 | 0.080 |
| | 1" | 1.125 | 0.921 | 0.102 |
| | 1-1/4" | 1.375 | 1.125 | 0.125 |
| ASTM | SCH. 40 | OD | ID | Wall |
| D1785 | 1/2" | 0.840 | 0.622 | 0.109 |
| | 3/4" | 1.050 | 0.824 | 0.113 |
| | 1" | 1.315 | 1.049 | 0.133 |
| | SCH. 40 FITTINGS D2466 | 1-1/4" | 1.660 | 1.380 |
| SCH. 40 FITTINGS D2466 | 1-1/2" | 1.900 | 1.610 | 0.145 |
| | 2" | 2.375 | 2.067 | 0.154 |
| | 2-1/2" | 2.875 | 2.469 | 0.203 |
| | 3" | 3.500 | 3.068 | 0.216 |
| | 4" | 4.500 | 4.026 | 0.237 |
| | 6" | 6.625 | 6.065 | 0.280 |
| | 8" | 8.625 | 7.981 | 0.322 |
| ASTM | SCH. 80 | OD | ID | Wall |
| D1785 | 1/2" | 0.840 | 0.546 | 0.147 |
| | 3/4" | 1.050 | 0.742 | 0.154 |
| | 1" | 1.315 | 0.957 | 0.179 |
| | 1-1/4" | 1.660 | 1.278 | 0.191 |
| SCH. 80 FITTINGS D2467 | 1-1/2" | 1.900 | 1.500 | 0.200 |
| | 2" | 2.375 | 1.939 | 0.218 |
| | 2-1/2" | 2.875 | 2.323 | 0.276 |
| ASTM | CTS TYPE L | OD | ID | Wall |
| B88 | 1/2" | 0.625 | 0.545 | 0.040 |
| | 5/8" | 0.750 | 0.666 | 0.042 |
| | 3/4" | 0.875 | 0.785 | 0.045 |
| | 1" | 1.125 | 1.025 | 0.050 |
| | 1-1/4" | 1.375 | 1.265 | 0.055 |
| | 1-1/2" | 1.625 | 1.505 | 0.060 |
| | 2" | 2.125 | 1.985 | 0.070 |
| | 2-1/2" | 2.625 | 2.465 | 0.080 |
| | 3" | 3.125 | 2.945 | 0.090 |
| | ASTM D2666 | SDR-13.5 | OD | ID |
| 1" | | | 1.125 | 0.959 |

FLOW MANAGEMENT PRODUCTS INDEX

| Part No. | Page | Part No. | Page | Part No. | Page | Part No. | Page | Part No. | Page | Part No. | Page | Part No. | Page |
|-----------|------|-------------|------|------------|------|-----------|------|----------|------|-------------|------|------------|------|
| 22-040 | 160 | 810-07 | 145 | 1050C20 | 151 | 1520C20 | 153 | 3260 | 160 | boa-104 | 144 | CPT-1000-S | 143 |
| 23-25T | 160 | 810-10 | 145 | 1050C20-05 | 151 | 1520C20F | 153 | 3280 | 160 | boa-106 | 144 | CPT-1000-T | 143 |
| 112-05 | 147 | 830-07 | 145 | 1050C20-10 | 151 | 1520C30 | 153 | 105010 | 151 | BTU-0500-E | 156 | CPT-1250-S | 143 |
| 112-07 | 147 | 830-10 | 145 | 1050C20-12 | 151 | 1520C40 | 153 | 105020 | 151 | BTU-0500-HL | 156 | CPT-1250-T | 143 |
| 112-10 | 147 | 830-71 | 145 | 1050C20-15 | 151 | 1520V20 | 153 | 107015BK | 151 | BTU-0500-V | 156 | CPT-1500-S | 143 |
| 112-12 | 147 | 830-121 | 145 | 1053C20 | 151 | 1700-07 | 150 | 321507P | 161 | BTU-0750-E | 156 | CPT-1500-T | 143 |
| 112-15 | 147 | 831-07 | 145 | 1055C20 | 151 | 1700-10 | 150 | 321510P | 161 | BTU-0750-HL | 156 | CPT-2000-S | 143 |
| 112-20 | 147 | 831-10 | 145 | 1071GH | 151 | 1700-15 | 150 | 322010P | 161 | BTU-0750-V | 156 | CPT-2000-T | 143 |
| 118-05 | 148 | 833-07 | 145 | 1091-20 | 150 | 1700-20 | 150 | 331510P | 161 | BTU-1000-E | 156 | CRE-0500-3 | 163 |
| 118-07 | 148 | 833-10 | 145 | 1095-20 | 150 | 1700C07 | 150 | 332007P | 161 | BTU-1000-HL | 156 | CRE-0750-4 | 163 |
| 118-10 | 148 | 833-71 | 145 | 1136-07 | 150 | 1700C10 | 150 | 332010P | 161 | BTU-1000-V | 156 | CRT-0750-T | 143 |
| 118-12 | 148 | 935-07 | 147 | 1136-07-05 | 150 | 1700C15 | 150 | 344007P | 161 | BTU-1250-E | 156 | CV-0500-FF | 152 |
| 118-15 | 148 | 935-10 | 147 | 1171V57 | 152 | 1700C20 | 150 | 353010P | 161 | BTU-1250-HL | 156 | CV-0500-FM | 152 |
| 118-20 | 148 | 935-12 | 147 | 1205-05 | 151 | 1700C30 | 150 | 421507 | 161 | BTU-1250-V | 156 | CV-0500-MF | 152 |
| 118-25 | 148 | 935-15 | 147 | 1205-07 | 151 | 1702-15 | 150 | 421510 | 161 | BTU-1500-E | 156 | CV-0575-FM | 152 |
| 118-30 | 148 | 935-20 | 147 | 1205-07-20 | 151 | 1702-20 | 150 | 422007 | 161 | BTU-1500-HL | 156 | CV-0750-FF | 152 |
| 118-40 | 148 | 935-125 | 147 | 1205-10 | 151 | 1702C15 | 150 | 422010 | 161 | BTU-1500-V | 156 | CV-0750-FM | 152 |
| 118-60QF | 148 | 1001-05 | 149 | 1205-12 | 151 | 1702C20 | 150 | 422012 | 161 | BTU-2000-E | 156 | CV-0750-MF | 152 |
| 135-05 | 147 | 1001-07 | 149 | 1205-15 | 151 | 1720-07 | 154 | 422015 | 161 | BTU-2000-HL | 156 | CV-1000-FF | 152 |
| 135-07 | 147 | 1001-10 | 149 | 1205-20 | 151 | 1720-10 | 154 | 422507 | 161 | BTU-2000-V | 156 | CV-1000-FM | 152 |
| 135-10 | 147 | 1001-10FV | 148 | 1205V07 | 151 | 1720-15 | 154 | 422510 | 161 | BTU-2500-SE | 156 | CV-1000-MF | 152 |
| 135-12 | 147 | 1001-12 | 149 | 1225-07 | 151 | 1720-20 | 154 | 422515 | 161 | BTU-2500-TE | 156 | E1310-05 | 155 |
| 135-15 | 147 | 1001-12FV | 148 | 1225-10 | 151 | 1720-30 | 154 | 422520 | 161 | BTU-3000-SE | 156 | E1310-07 | 155 |
| 135-20 | 147 | 1001-15 | 149 | 1225-15 | 151 | 1720C07 | 154 | 432007 | 161 | BTU-3000-TE | 156 | E1310-10 | 155 |
| 136-05 | 147 | 1001-15FV | 148 | 1228V15 | 151 | 1720C10 | 154 | 432010 | 161 | BTU-3000-TV | 156 | E1310-12 | 155 |
| 136-07 | 147 | 1001-20 | 149 | 1235-05 | 152 | 1720C15 | 154 | 432012 | 161 | BTU-4000-SE | 156 | E1310-15 | 155 |
| 136-10 | 147 | 1001-20FV | 148 | 1235-05-30 | 152 | 1720C20 | 154 | 432015 | 161 | BTU-4000-TE | 156 | E1310-20 | 155 |
| 136-20 | 147 | 1001-25 | 149 | 1235-07 | 152 | 1720C30 | 154 | 432510 | 161 | C1310-05 | 157 | E1310-25 | 155 |
| 235-05 | 147 | 1001-30 | 149 | 1235-10 | 152 | 1750-20 | 152 | 432515 | 161 | C1310-07 | 157 | E1310-30 | 155 |
| 235-07 | 147 | 1002-05 | 149 | 1351-15 | 155 | 1753-20 | 152 | 432520 | 161 | C1310-10 | 157 | E1310-40 | 155 |
| 235-10 | 147 | 1002-07 | 149 | 1351-20 | 155 | 1790-15 | 150 | 443007 | 161 | C1310-12 | 157 | E1310-60 | 155 |
| 235-12 | 147 | 1002-10 | 149 | 1400-15 | 154 | 1790-20 | 150 | 443010 | 161 | C1310-15 | 157 | E1320-05 | 155 |
| 235-15 | 147 | 1002-12 | 149 | 1500-12 | 153 | 1790C15 | 150 | 443012 | 161 | C1310-20 | 157 | E1320-07 | 155 |
| 235-20 | 147 | 1002-15 | 149 | 1500-15 | 153 | 1790C20 | 150 | 443015 | 161 | CCC-0500 | 144 | E1320-10 | 155 |
| 410-05 | 144 | 1002-20 | 149 | 1500-20 | 153 | 1795C20 | 150 | 443020 | 161 | CCC-0750 | 144 | E1320-12 | 155 |
| 410-07 | 144 | 1002-25 | 149 | 1500-30 | 153 | 1800-07 | 148 | 444007 | 161 | CCC-1000 | 144 | E1320-15 | 155 |
| 410-10 | 144 | 1002-30 | 149 | 1500C15 | 153 | 1800-10 | 148 | 444010 | 161 | CCC-1250 | 144 | E1320-20 | 155 |
| 710-07 | 146 | 1010-05-0 | 152 | 1500C20 | 153 | 1800-12 | 148 | 444012 | 161 | CCT-0500 | 144 | E1320-25 | 155 |
| 710-10 | 146 | 1010-07-0 | 152 | 1520-05 | 153 | 1800-15 | 148 | 444015 | 161 | CCT-0750 | 144 | E1320-30 | 155 |
| 710-12 | 146 | 1011-05 | 149 | 1520-05F | 153 | 1800-20 | 148 | 444020 | 161 | CCT-1000 | 144 | E1320-40 | 155 |
| 710-15 | 146 | 1011-05-025 | 149 | 1520-07 | 153 | 1901-15 | 150 | 446007 | 161 | CCT-1250 | 144 | E1410-05 | 155 |
| 710-17 | 146 | 1011-07 | 149 | 1520-07F | 153 | 1901-20 | 150 | 446010 | 161 | CCT-1500 | 144 | E1410-07 | 155 |
| 710-17-9 | 146 | 1011-07-025 | 149 | 1520-10 | 153 | 1903-15 | 150 | 446012 | 161 | CCT-2000 | 144 | E1410-10 | 155 |
| 710-20 | 146 | 1011-10 | 149 | 1520-10F | 153 | 1903-20 | 150 | 446015 | 161 | CPA-0500 | 144 | E1410-12 | 155 |
| 730-07 | 146 | 1011-12 | 149 | 1520-12 | 153 | 1930-15 | 155 | 446020 | 161 | CPA-0750 | 144 | E1410-15 | 155 |
| 730-10 | 146 | 1011-15 | 149 | 1520-12F | 153 | 1930-20 | 155 | 448007 | 161 | CPA-1000 | 144 | E1410-20 | 155 |
| 730-12 | 146 | 1011-20 | 149 | 1520-15 | 153 | 2200-15 | 154 | 448010 | 161 | CPA-1250 | 144 | E1410-25 | 155 |
| 730-15 | 146 | 1011-25 | 149 | 1520-15F | 153 | 2200-15TU | 154 | 448015 | 161 | CPA-1500 | 144 | E1410-30 | 155 |
| 730-20 | 146 | 1011-30 | 149 | 1520-20 | 153 | 2200-15UC | 154 | 448020 | 161 | CPA-2000 | 144 | E1410-40 | 155 |
| 730-71 | 146 | 1011C10 | 149 | 1520-20F | 153 | 2200-20 | 154 | 453007 | 161 | CPC-0500 | 143 | E1420-05 | 155 |
| 731-07 | 146 | 1011C12 | 149 | 1520-30 | 153 | 2200-20TU | 154 | 453010 | 161 | CPC-0750 | 143 | E1420-07 | 155 |
| 731-10 | 146 | 1011C15 | 149 | 1520-40 | 153 | 2200-20UC | 154 | 453012 | 161 | CPC-1000 | 143 | E1420-10 | 155 |
| 731-12 | 146 | 1011C20 | 149 | 1520C05 | 153 | 2200C20TU | 154 | 453015 | 161 | CPC-1250 | 143 | E1420-12 | 155 |
| 731-12-10 | 146 | 1012-05 | 149 | 1520C05F | 153 | 3115 | 160 | 453020 | 161 | CPC-1500 | 143 | E1420-15 | 155 |
| 731-15 | 146 | 1012-07 | 149 | 1520C07 | 153 | 3120 | 160 | 454007 | 161 | CPC-2000 | 143 | E1420-20 | 155 |
| 731-20 | 146 | 1012-10 | 149 | 1520C07F | 153 | 3125 | 160 | 454010 | 161 | CPC-2500 | 143 | E1420-25 | 155 |
| 731-71 | 146 | 1012-12 | 149 | 1520C10 | 153 | 3130 | 160 | 454015 | 161 | CPC-3000 | 143 | E1420-30 | 155 |
| 733-07 | 146 | 1012-15 | 149 | 1520C10F | 153 | 3140 | 160 | 454020 | 161 | CPC-4000 | 143 | E1420-40 | 155 |
| 733-10 | 146 | 1012-20 | 149 | 1520C12 | 153 | 3160 | 160 | 456010 | 161 | CPC-6000 | 143 | E1610-05 | 156 |
| 733-12 | 146 | 1012-25 | 149 | 1520C15 | 153 | 3220 | 160 | 456015 | 161 | CPT-0500-S | 143 | E1610-07 | 156 |
| 733-15 | 146 | 1012-30 | 149 | 1520C15F | 153 | 3225 | 160 | 456020 | 161 | CPT-0500-T | 143 | E1610-10 | 156 |
| 733-20 | 146 | 1015-25 | 149 | 1520C15FV | 153 | 3230 | 160 | 458015 | 161 | CPT-0750-S | 143 | E1610-12 | 156 |
| 733-71 | 146 | 1050C10 | 151 | 1520C15V | 153 | 3240 | 160 | 458020 | 161 | CPT-0750-T | 143 | E1610-15 | 156 |



FITTINGS & CLAMPS



FITTINGS & CLAMPS

Our comprehensive line of sewer and drain fittings includes valves, couplings, and connectors in PVC and styrene. NDS continues its tradition of innovation with the new patent pending Swivel-Fit™ variable angle fitting that combines two fixed fittings into one adjustable fitting solution.

SOLVENT-WELD SEWER & DRAIN FITTINGS

Standards

PVC ASTM D-3034, D-2729

Abbreviations

Hub = Hub Socket (receives pipe & Fitting SPT)

Spt= Spigot (pipe diameter, connect to fitting Hub)

MPT = Male Pipe Thread

FPT = Female Pipe Thread

DWV = Drain, Waste and Vent (Schedule 40 dimensions)

S&D = Sewer and Drain

PVC = Polyvinyl Chloride

HIPS = High-Impact Polystyrene



One Adjustable Fitting for Any Job

The patent-pending Swivel Fit® Variable Angle Fitting can be set to any angle from 0° to 90°. It is a convenient solution to tackle any job and is easy and less expensive than connecting multiple fixed angle fittings.

FITTINGS & CLAMPS

Variable Angle Fittings

Patent Pending



| Part No. | Description | Color | Pkg. Qty. | Wt. Ea. (lbs.) | Product Class |
|----------|--|-------|-----------|----------------|---------------|
| 4PVAF | PVC S&D Swivel-Fit™ 0-90° Variable-Angled Fitting, 4 in. Hub X Hub | White | 12 | 1.00 | 30PV |

SOLVENT-WELD SEWER & DRAIN FITTINGS

Tee

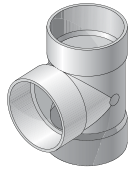

| Part No. | Description | Color | Pkg. Qty. | Wt. Ea. (lbs.) | Product Class |
|----------|--|-------|-----------|----------------|---------------|
| 3P01 | PVC S&D Tee, 3 in. Hub X Hub X Hub | White | 35 | 0.57 | 30PV |
| 4P01 | PVC S&D Tee, 4 in. Hub X Hub X Hub | White | 20 | 0.95 | 30PV |
| 6P01 | PVC S&D Tee, 6 in. Hub X Hub X Hub | White | 9 | 3.66 | 30PV |
| 64P01 | PVC S&D Tee, 6 in. Hub X Hub X 4 in. Hub | White | 8 | 2.38 | 30PV |
| 8P01 | PVC S&D Tee, 8 in. Hub X Hub X Hub | White | 2 | 3.00 | 30PV |
| 84P01 | PVC S&D Tee, 8 in. Hub X Hub X 4 in. Hub | White | 7 | 4.72 | 30PV |
| 86P01 | PVC S&D Tee, 8 in. Hub X Hub X 6 in. Hub | White | 3 | 5.00 | 30PV |

Double Cleanout

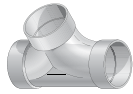

| Part No. | Description | Color | Pkg. Qty. | Wt. Ea. (lbs.) | Product Class |
|----------|--|-------|-----------|----------------|---------------|
| 417P | PVC S&D Double Cleanout, 4 in. Hub X Hub X Hub | White | 24 | 1.41 | 30PV |

90 Degree Elbow

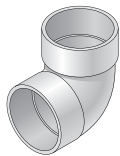

| Part No. | Description | Color | Pkg. Qty. | Wt. Ea. (lbs.) | Product Class |
|----------|------------------------------------|-------|-----------|----------------|---------------|
| 3P02 | PVC S&D 90° Elbow, 3 in. Hub X Hub | White | 40 | 0.40 | 30PV |
| 4P02 | PVC S&D 90° Elbow, 4 in. Hub X Hub | White | 25 | 0.68 | 30PV |
| 6P02 | PVC S&D 90° Elbow, 6 in. Hub X Hub | White | 6 | 3.00 | 30PV |
| 8P02 | PVC S&D 90° Elbow, 8 in. Hub X Hub | White | 4 | 6.50 | 30PV |

90 Degree Long-Turn Elbow

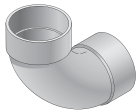

| Part No. | Description | Color | Pkg. Qty. | Wt. Ea. (lbs.) | Product Class |
|----------|--|-------|-----------|----------------|---------------|
| 31P0 | PVC S&D 90° Long-Turn Elbow, 3 in. Hub X Hub | White | 30 | 0.46 | 30PV |
| 41P0 | PVC S&D 90° Long-Turn Elbow, 4 in. Hub X Hub | White | 20 | 0.85 | 30PV |
| 61P0 | PVC S&D 90° Long-Turn Elbow, 6 in. Hub X Hub | White | 8 | 3.10 | 30PV |

90 Degree Long-Turn Street Elbow

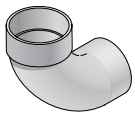

| Part No. | Description | Color | Pkg. Qty. | Wt. Ea. (lbs.) | Product Class |
|----------|---|-------|-----------|----------------|---------------|
| 31POST | PVC S&D 90° Long-Turn Street Elbow, 3 in. Hub X Spt | White | 20 | 0.90 | 30PV |
| 41POST | PVC S&D 90° Long-Turn Street Elbow, 4 in. Hub X Spt | White | 20 | 1.25 | 30PV |

45 Degree Elbow

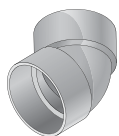

| Part No. | Description | Color | Pkg. Qty. | Wt. Ea. (lbs.) | Product Class |
|----------|------------------------------------|-------|-----------|----------------|---------------|
| 3P03 | PVC S&D 45° Elbow, 3 in. Hub X Hub | White | 40 | 0.32 | 30PV |
| 4P03 | PVC S&D 45° Elbow, 4 in. Hub X Hub | White | 30 | 0.53 | 30PV |
| 6P03 | PVC S&D 45° Elbow, 6 in. Hub X Hub | White | 8 | 2.12 | 30PV |
| 8P03 | PVC S&D 45° Elbow, 8 in. Hub X Hub | White | 6 | 4.33 | 30PV |

SOLVENT-WELD SEWER & DRAIN FITTINGS

45 Degree Street Elbow

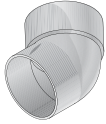

| Part No. | Description | Color | Pkg. Qty. | Wt. Ea. (lbs.) | Product Class |
|----------|---|-------|-----------|----------------|---------------|
| 3P03ST | PVC S&D 45° Street Elbow, 3 in. Hub X Spt | White | 30 | 0.33 | 30PV |
| 4P03ST | PVC S&D 45° Street Elbow, 4 in. Hub X Spt | White | 30 | 0.86 | 30PV |
| 6P03ST | PVC S&D 45° Street Elbow, 6 in. Hub X Spt | White | 10 | 1.80 | 30PV |

22-1/2 Degree Elbow

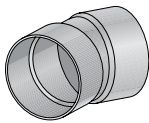

| Part No. | Description | Color | Pkg. Qty. | Wt. Ea. (lbs.) | Product Class |
|----------|--------------------------------------|-------|-----------|----------------|---------------|
| 3P04 | PVC S&D 22.5° Elbow, 3 in. Hub X Hub | White | 25 | 0.32 | 30PV |
| 4P04 | PVC S&D 22.5° Elbow, 4 in. Hub X Hub | White | 20 | 0.45 | 30PV |
| 6P04 | PVC S&D 22.5° Elbow, 6 in. Hub X Hub | White | 20 | 1.60 | 30PV |

Coupling

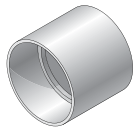

| Part No. | Description | Color | Pkg. Qty. | Wt. Ea. (lbs.) | Product Class |
|----------|-----------------------------------|-------|-----------|----------------|---------------|
| 3P05 | PVC S&D Coupling, 3 in. Hub X Hub | White | 120 | 0.22 | 30PV |
| 4P05 | PVC S&D Coupling, 4 in. Hub X Hub | White | 45 | 0.37 | 30PV |
| 6P05 | PVC S&D Coupling, 6 in. Hub X Hub | White | 10 | 1.30 | 30PV |
| 8P05 | PVC S&D Coupling, 8 in. Hub X Hub | White | 6 | 3.33 | 30PV |

Slip Repair Coupling

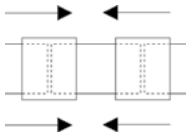

| Part No. | Description | Color | Pkg. Qty. | Wt. Ea. (lbs.) | Product Class |
|----------|---|-------|-----------|----------------|---------------|
| 3P05R | PVC S&D Slip Repair Coupling, 3 in. Hub X Hub | White | 60 | 0.25 | 30PV |
| 4P05R | PVC S&D Slip Repair Coupling, 4 in. Hub X Hub | White | 45 | 0.46 | 30PV |

Increaser/Reducer Bushing



| Part No. | Description | Color | Pkg. Qty. | Wt. Ea. (lbs.) | Product Class |
|----------|--|-------|-----------|----------------|---------------|
| 3P07 | PVC S&D Increaser/Reducer Bushing, 3 in. Hub X 4 in. Spt | White | 20 | 0.45 | 30PV |
| 6P07S | PVC S&D Increaser/Reducer Bushing, 4 in. Hub X 6 in. Spt | White | 20 | 1.10 | 30PV |

Increaser/Reducer Coupling

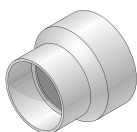

| Part No. | Description | Color | Pkg. Qty. | Wt. Ea. (lbs.) | Product Class |
|----------|---|-------|-----------|----------------|---------------|
| 4P07 | PVC S&D Increaser/Reducer Coupling, 3 in. Hub X 4 in. Hub | White | 30 | 0.36 | 30PV |
| 6P07 | PVC S&D Increaser/Reducer Coupling, 4 in. Hub X 6 in. Hub | White | 20 | 1.10 | 30PV |
| 8P07 | PVC S&D Increaser/Reducer Coupling, 6 in. Hub X 8 in. Hub | White | 1 | 3.00 | 30PV |

SOLVENT-WELD SEWER & DRAIN FITTINGS

45 Degree Wye

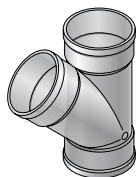

| Part No. | Description | Color | Pkg. Qty. | Wt. Ea. (lbs.) | Product Class |
|----------|--|-------|-----------|----------------|---------------|
| 3P08 | PVC S&D 45° Wye, 3 in. Hub X Hub X Hub | White | 25 | 0.88 | 30PV |
| 4P08 | PVC S&D 45° Wye, 4 in. Hub X Hub X Hub | White | 20 | 1.25 | 30PV |
| 6P08 | PVC S&D 45° Wye, 6 in. Hub X Hub X Hub | White | 6 | 4.66 | 30PV |
| 64P08 | PVC S&D 45° Wye, 6 in. Hub X Hub X 4 in. Hub | White | 8 | 2.88 | 30PV |
| 8P08 | PVC S&D 45° Wye, 8 in. Hub X Hub X Hub | White | 2 | 11.00 | 30PV |
| 84P08 | PVC S&D 45° Wye, 8 in. Hub X Hub X 4 in. Hub | White | 6 | 5.33 | 30PV |
| 86P08 | PVC S&D 45° Wye, 8 in. Hub X Hub X 6 in. Hub | White | 3 | 3.33 | 30PV |

Sanitary (Sweep) Tee



| Part No. | Description | Color | Pkg. Qty. | Wt. Ea. (lbs.) | Product Class |
|----------|---|-------|-----------|----------------|---------------|
| 3P09 | PVC S&D Sanitary Tee, 3 in. Hub X Hub X Hub | White | 30 | 0.66 | 30PV |
| 4P09 | PVC S&D Sanitary Tee, 4 in. Hub X Hub X Hub | White | 20 | 1.60 | 30PV |
| 6P09 | PVC S&D Sanitary Tee, 6 in. Hub X Hub X Hub | White | 5 | 4.20 | 30PV |
| 8P09 | PVC S&D Sanitary Tee, 8 in. Hub X Hub X Hub | White | 1 | 15.00 | 30PV |

Cap

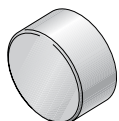

| Part No. | Description | Color | Pkg. Qty. | Wt. Ea. (lbs.) | Product Class |
|----------|------------------------|-------|-----------|----------------|---------------|
| 3P06 | PVC S&D Cap, 3 in. Hub | White | 25 | 0.20 | 30PV |
| 4P06 | PVC S&D Cap, 4 in. Hub | White | 25 | 0.28 | 30PV |
| 6P06 | PVC S&D Cap, 6 in. Hub | White | 15 | 0.93 | 30PV |
| 8P06 | PVC S&D Cap, 8 in. Hub | White | 10 | 2.40 | 30PV |

Female Cleanout Adapter



| Part No. | Description | Color | Pkg. Qty. | Wt. Ea. (lbs.) | Product Class |
|----------|--|-------|-----------|----------------|---------------|
| 3P11 | PVC S&D Female Cleanout Adapter, 3 in. Hub X FPT | White | 25 | 0.36 | 30PV |
| 4P11 | PVC S&D Female Cleanout Adapter, 4 in. Hub X FPT | White | 20 | 0.55 | 30PV |
| 613P | PVC S&D Female Cleanout Adapter, 6 in. Hub X FPT | White | 24 | 1.08 | 30PV |

Female Fitting Cleanout Adapter

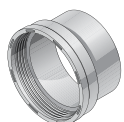

| Part No. | Description | Color | Pkg. Qty. | Wt. Ea. (lbs.) | Product Class |
|----------|--|-------|-----------|----------------|---------------|
| 413P | PVC S&D Female Fitting Cleanout Adapter, 4 in. Spt X FPT | White | 20 | 0.50 | 30PV |

Cleanout Plug

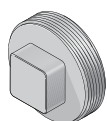

| Part No. | Description | Color | Pkg. Qty. | Wt. Ea. (lbs.) | Product Class |
|----------|----------------------------------|-------|-----------|----------------|---------------|
| 31P8 | PVC S&D Cleanout Plug, 3 in. MPT | White | 50 | 0.30 | 30PV |
| 41P8 | PVC S&D Cleanout Plug, 4 in. MPT | White | 30 | 0.36 | 30PV |
| 61P8 | PVC S&D Cleanout Plug, 6 in. MPT | White | 24 | 0.62 | 30PV |

SOLVENT-WELD SEWER & DRAIN FITTINGS

Swivel-Fit™ Variable-Angled Fitting

Patent Pending



| Part No. | Description | Color | Pkg. Qty. | Wt. Ea. (lbs.) | Product Class |
|----------|--|-------|-----------|----------------|---------------|
| 4PVAF | PVC S&D Swivel-Fit™ 0-90° Variable-Angled Fitting, 4 in. Hub X Hub | White | 12 | 1.00 | 30PV |

Cross



| Part No. | Description | Color | Pkg. Qty. | Wt. Ea. (lbs.) | Product Class |
|----------|--|-------|-----------|----------------|---------------|
| 4P1X | PVC S&D Cross, 4 in. Hub X Hub X Hub X Hub | White | 20 | 1.40 | 30PV |

Adapter (DWV/SCH40 to S&D)

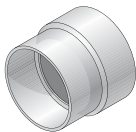

| Part No. | Description | Color | Pkg. Qty. | Wt. Ea. (lbs.) | Product Class |
|----------|--|-------|-----------|----------------|---------------|
| 3P15 | PVC Adapter, 3 in. DWV/SCH40 Hub X S&D Hub | White | 60 | 0.35 | 30PV |
| 3P16 | PVC Adapter, 4 in. DWV/SCH40 Hub X S&D Hub | White | 30 | 0.80 | 30PV |

Adapter Bushing (DWV/SCH40 to S&D)



| Part No. | Description | Color | Pkg. Qty. | Wt. Ea. (lbs.) | Product Class |
|----------|--|-------|-----------|----------------|---------------|
| 2P41 | PVC Adapter Bushing, 3 in. DWV/SCH40 Spt X S&D Hub | White | 50 | 0.12 | 30PV |
| 2P42 | PVC Adapter Bushing, 4 in. DWV/SCH40 Spt X S&D Hub | White | 25 | 0.24 | 30PV |
| 2P43 | PVC Adapter Bushing, 6 in. DWV/SCH40 Spt X S&D Hub | White | 20 | 0.70 | 30PV |

Increaser/Reducer Adapter (DWV/SCH40 to S&D)

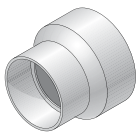

| Part No. | Description | Color | Pkg. Qty. | Wt. Ea. (lbs.) | Product Class |
|----------|--|-------|-----------|----------------|---------------|
| 533 | PVC Increaser/Reducer Adapter, 2 in. DWV/SCH40 Hub X 4 in. S&D Spt | White | 20 | 0.35 | 30PV |
| 3P12 | PVC Increaser/Reducer Adapter, 3 in. DWV/SCH40 Hub X 4 in. S&D Hub | White | 50 | 0.50 | 30PV |
| 3P17 | PVC Increaser/Reducer Adapter, 3 in. DWV/SCH40 Hub X 4 in. S&D Spt | White | 30 | 0.35 | 30PV |

Increaser/Reducer Adapter Bushing (DWV/SCH40 to S&D)



| Part No. | Description | Color | Pkg. Qty. | Wt. Ea. (lbs.) | Product Class |
|----------|--|-------|-----------|----------------|---------------|
| 532 | PVC Increaser/Reducer Adapter Bushing, 2 in. DWV/SCH40 Hub X 3 in. S&D Spt | White | 20 | 0.20 | 30PV |

SOLVENT-WELD SEWER & DRAIN FITTINGS

Downspout Adapter for Sewer & Drain Pipe

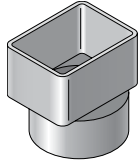

| Part No. | Description | Color | Pkg. Qty. | Wt. Ea. (lbs.) | Product Class |
|----------|---|-------|-----------|----------------|---------------|
| 9P03 | PVC Offset Downspout Adapter, 2X3 in. Downspout X 3 in. S&D Hub | White | 40 | 0.42 | 30PV |
| 9P04 | PVC Offset Downspout Adapter, 2X3 in. Downspout X 4 in. S&D Hub | White | 30 | 0.53 | 30PV |
| 9P06 | PVC Downspout Adapter, 3X4 in. Downspout X 4 in. S&D Hub | White | 25 | 0.50 | 30PV |
| 9P10 | PVC Offset Downspout Adapter, 4X6 in. Downspout X 6 in. S&D Hub | White | 15 | 1.00 | 30PV |
| 9P13 | PVC Offset Downspout Adapter, 3X4 in. Downspout X 4 in. S&D Hub | White | 25 | 0.50 | 30PV |

Downspout Adapter for DWV/Schedule 40 Pipe

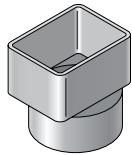

| Part No. | Description | Color | Pkg. Qty. | Wt. Ea. (lbs.) | Product Class |
|----------|--|-------|-----------|----------------|---------------|
| 9P07 | PVC Downspout Adapter, 2X3 in. Downspout X 3 in. DWV/SCH40 Hub | White | 40 | 0.30 | 30PV |
| 9P08 | PVC Downspout Adapter, 2X3 in. Downspout X 4 in. DWV/SCH40 Hub | White | 30 | 1.10 | 30PV |
| 9P09 | PVC Downspout Adapter, 3X4 in. Downspout X 4 in. DWV/SCH40 Hub | White | 30 | 0.44 | 30PV |

POOL ACCESSORIES

Drain Grate



| Part No. | Description | Color | Pkg. Qty. | Wt. Ea. (lbs.) | Product Class |
|----------|--|-------|-----------|----------------|---------------|
| 9P12 | 3 in. PVC Round Grate, Fits 3 in. Sewer & Drain Fittings | White | 50 | 0.16 | 30PV |
| 9P11 | 4 in. PVC Round Grate, Fits 4 in. Sewer & Drain Fittings | White | 25 | 0.36 | 30PV |

Deck Drain



| Part No. | Description | Color | Pkg. Qty. | Wt. Ea. (lbs.) | Product Class |
|----------|--------------------------------|-------|-----------|----------------|---------------|
| WC100 | HIPS S&D Deck Drain, 3 in. Hub | White | 50 | 0.16 | 30ST |
| WC100G | HIPS S&D Deck Drain, 3 in. Hub | Gray | 50 | 0.16 | 30ST |
| WC100T | HIPS S&D Deck Drain, 3 in. Hub | Tan | 50 | 0.16 | 30ST |

Pool Backflush Fitting

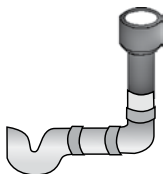

| Part No. | Description | Color | Pkg. Qty. | Wt. Ea. (lbs.) | Product Class |
|----------|--|-------|-----------|----------------|---------------|
| 650 | HDPE Pool Backflush Fitting with Recessed Grate, 4 in. tapered Spt (Includes removable 4" grate NDS #11) | Black | 35 | 0.16 | 30ST |

CORRUGATED FITTINGS

Coupling



| Part No. | Description | Color | Pkg. Qty. | Wt. Ea. (lbs.) | Product Class |
|----------|-------------------------------|-------|-----------|----------------|---------------|
| 3C05 | HDPE Internal Coupling, 3 in. | Black | 60 | 0.30 | 11RP |
| 4C07 | HDPE Internal Coupling, 4 in. | Black | 36 | 0.30 | 11RP |
| 6C05 | HDPE Internal Coupling, 6 in. | Black | 12 | 0.80 | 11RP |

End Cap



| Part No. | Description | Color | Pkg. Qty. | Wt. Ea. (lbs.) | Product Class |
|----------|---------------------|-------|-----------|----------------|---------------|
| 3C06 | HDPE End Cap, 3 in. | Black | 33 | 0.30 | 11RP |
| 4C06 | HDPE End Cap, 4 in. | Black | 32 | 0.50 | 11RP |
| 6C06 | HDPE End Cap, 6 in. | Black | 15 | 0.50 | 11RP |

Adapter

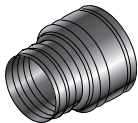

| Part No. | Description | Color | Pkg. Qty. | Wt. Ea. (lbs.) | Product Class |
|----------|---|-------|-----------|----------------|---------------|
| 351 | HDPE Corrugated Adapter, 3 in. Drain Pipes & Fittings Spt X 3 in. Corr. Hub | Black | 50 | 0.10 | 30PV |
| 451 | HDPE Corrugated Adapter, 4 in. Drain Pipes & Fittings Spt X 4 in. Corr. Hub | Black | 25 | 0.20 | 30PV |
| 651 | HDPE Corrugated Adapter, 6 in. Drain Pipes & Fittings Spt X 6 in. Corr. Hub | Black | 12 | 0.25 | 30PV |

Downspout Adapter



| Part No. | Description | Color | Pkg. Qty. | Wt. Ea. (lbs.) | Product Class |
|----------|---|-------|-----------|----------------|---------------|
| 234CDS | HDPE Downspout Adapter, 2X3 in. Downspout X 4 in. Corr. Hub | Black | 24 | 0.20 | 30ST |
| 344CDS | HDPE Downspout Adapter, 3X4 in. Downspout X 4 in. Corr. Hub | Black | 24 | 0.20 | 30ST |

DIVERTER AND BACKWATER VALVES

Diverter Valve

Here's the simplest, strongest and most economical diverter valve ever invented for septic tank leach fields. It is made of tough molded plastic that will not shatter, bend, rust or corrode. It is lighter in weight, easier to handle and less expensive to ship.

Functional

The diverter valve stem flow may be controlled to individual or multiple fields (up to three) in any combination. With a three-way valve stem, flow may be diverted to any two outlets. To allow flow through all outlets, the valve stem may be removed from the assembly.

Easy to Install

Connect 4" plastic sewer and drain pipe to inlets and outlets on the four-way distribution box. (Unwanted outlets may be sealed by installing caps.) The diverter shield which houses the diverter stem may be cut to desired length.

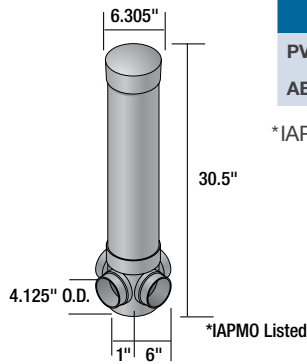

| | Part No. | Description | Color | Pkg. Qty. | Wt. Ea. (lbs.) | Product Class |
|------|----------|-----------------------|-------|-----------|----------------|---------------|
| PVC | 575P | 4" PVC Diverter Valve | White | 4 | 9.50 | 35PV |
| ABS* | 575 | 4" ABS Diverter Valve | Black | 4 | 7.50 | 35AB |

*IAPMO Listed.

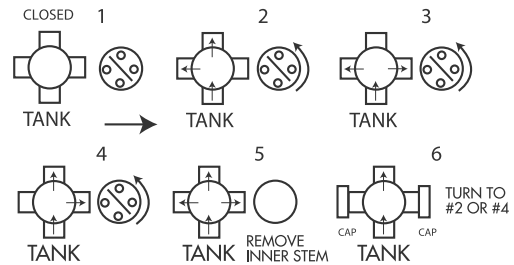

Gravity Backwater Valve

The NDS gravity flow Backwater Valve is designed to protect low areas or basements from the backflow of waste from street sewers. It is available in 2", 3", 4" and 6" sizes, PVC material. It is a cost-effective and a chemically resistant alternative to cast iron valves.

Backwater Valve

The quick action flapper allows unrestricted uni-directional flow. Elastomeric gasket in the flapper ensures a watertight seal. Flapper can be easily removed and replaced if required. Threaded access cap is designed for hand tightening. Access cap neoprene gasket provides a positive seal. Valve hub outlets fit 2", 3", 4" or 6" DWV pipe and may be adapted to 2", 3", 4" or 6" sewer and drain pipe with NDS DWV to Sewer & Drain Adapters. Lightweight, easy to install. Horizontal installation required, with arrows on top of the valve hub pointing in the direction of the flow of water. Access riser with cover offers a simple, economical access to the valve for inspection and maintenance. The riser may be cut to the desired length.

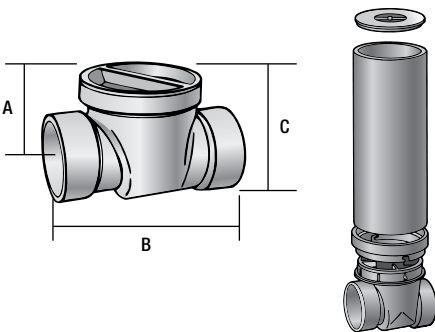

| Item Number | A | B | C | Riser Height | Riser Diameter |
|-------------|-------|--------|-------|--------------|----------------|
| 275P, 275 | 2.18" | 5.03" | 3.53" | 16" | 4" |
| 275PR | 2.18" | 5.03" | 3.53" | 16" | 4" |
| 375P, 375 | 3.51" | 7.56" | 6.10" | 16" | 6" |
| 375PR, 375R | 3.51" | 7.56" | 6.10" | 16" | 6" |
| 475P, 475 | 4.47" | 11.18" | 7.18" | 16" | 8" |
| 475PR, 475R | 4.47" | 11.18" | 7.18" | 16" | 8" |
| 675P, 675 | 5.50" | 15.25" | 9.90" | 16" | 10" |

Approvals applicable to valve only.



DIVERTER AND BACKWATER VALVES

Backwater Valve



| Part No. | Description | Color | Pkg. Qty. | Wt. Ea. (lbs.) | Product Class |
|----------|---|-------|-----------|----------------|---------------|
| 275P | 2" PVC Backwater Valve | White | 8 | 1.00 | 35PV |
| 275PR | 2" PVC Backwater Valve with Riser and Cover | White | 1 | 5.00 | 35PV |
| 375P | 3" PVC Backwater Valve | White | 6 | 2.33 | 35PV |
| 375PR | 3" PVC Backwater Valve with Riser and Cover | White | 1 | 5.00 | 35PV |
| 475P | 4" PVC Backwater Valve | White | 6 | 4.33 | 35PV |
| 475PR | 4" PVC Backwater Valve with Riser and Cover | White | 1 | 8.00 | 35PV |
| 675P | 6" PVC Backwater Valve | White | 1 | 9.00 | 35PV |
| 275 | 2" ABS Backwater Valve | Black | 8 | 1.00 | 35AB |
| 375 | 3" ABS Backwater Valve | Black | 6 | 1.83 | 35AB |
| 375R | 3" ABS Backwater Valve with Riser and Cover | Black | 1 | 4.00 | 35AB |
| 475 | 4" ABS Backwater Valve | Black | 6 | 3.33 | 35AB |
| 475R | 4" ABS Backwater Valve with Riser and Cover | Black | 1 | 7.00 | 35AB |
| 675 | 6" ABS Backwater Valve and Cover | Black | 1 | 7.00 | 35AB |

PVC Backwater Valve Components

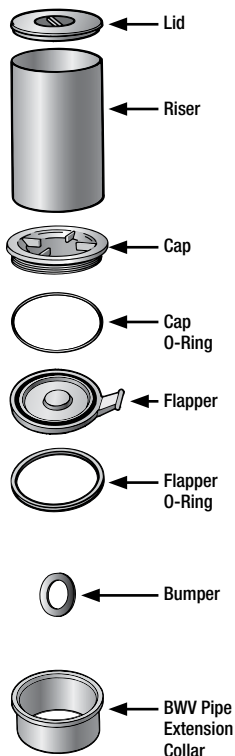

| Part No. | Description | Color | Carton Qty. | Product Class |
|--------------|--|-------|-------------|---------------|
| 8051-020-040 | 2" Lid | White | 20 | 35PV |
| 822-040-16 | 2" Riser | White | 4 | 35PV |
| 1530202 | 2" Cap | White | 10 | 35PV |
| 880-237 | 2" Cap O-Ring | Black | 10 | 35PV |
| 1530203 | 2" Flapper | White | 10 | 35PV |
| 880-136 | 2" Flapper O-Ring | Black | 10 | 35PV |
| 1530204 | 2" Backwater Valve Pipe Extension Collar | White | 10 | 35PV |
| 8051-030-060 | 3" Lid | White | 25 | 35PV |
| 822-060-16 | 3" Riser | White | 2 | 35PV |
| 1530302 | 3" Cap | White | 10 | 35PV |
| 880-253 | 3" Cap O-Ring | Black | 10 | 35PV |
| 1530303 | 3" Flapper | White | 10 | 35PV |
| 880-234 | 3" Flapper O-Ring | Black | 10 | 35PV |
| 1530304 | 3" Backwater Valve Pipe Extension Collar | White | 10 | 35PV |
| 8051-040-080 | 4" Lid | White | 20 | 35PV |
| 822-080-16 | 4" Riser | White | 1 | 35PV |
| 1530402 | 4" Cap | White | 10 | 35PV |
| 880-364 | 4" Cap O-Ring | Black | 10 | 35PV |
| 1530403 | 4" Flapper | White | 10 | 35PV |
| 880-243 | 4" Flapper O-Ring | Black | 10 | 35PV |
| 1530404 | 4" Backwater Valve Pipe Extension Collar | White | 10 | 35PV |
| 8051-060-100 | 6" Lid | White | 15 | 35PV |
| 1530602 | 6" Cap | White | 2 | 35PV |
| 880-271 | 6" Cap O-Ring | Black | 2 | 35PV |
| 1530603 | 6" Flapper | White | 5 | 35PV |
| 880-259 | 6" Flapper O-Ring | Black | 5 | 35PV |
| 880-202 | Bumper (fits all sizes of valves) | Black | 1 | 35PV |
| 1530405 | 4" BWV Sewer Adapt Flange | White | 1 | 35PV |
| 1530605 | 6" BWV Sewer Adapt Flange | White | 1 | 35PV |

FITTINGS & CLAMPS

Backwater Valve Box

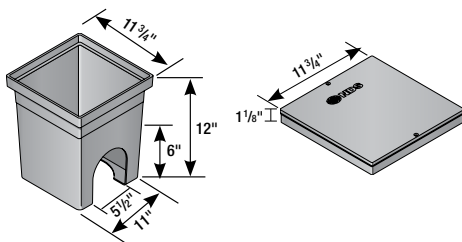

| Part No. | Description | Color | Pkg. Qty. | Wt. Ea. (lbs.) | Product Class |
|----------|-------------------------------|-------|-----------|----------------|---------------|
| 1219 | 12" x 12" Backwater Valve Box | Black | 4 | 5.75 | 10ND |
| 1220 | 12" x 12" Valve Box Cover | Black | 8 | 2.00 | 10ND |

NDS FLEXIBLE COUPLINGS AND CONNECTORS

- Choose the high-quality couplings and connectors that easily adapt to any situation
- Innovative, flexible couplings for sewer, drain, waste and vent piping allow any two pipes to be connected quickly and easily
- Dimensional flexibility ensures leakproof seals with virtually any pipe material
- Utility and plumbing applications

Details

- Couplings and connectors fit over the ends of plain-end or spigot pipe to form a positive seal against infiltration and exfiltration in non-pressure environments
- Durable PVC construction allows couplings to flex with normal earth movement
- Completely unaffected by soil conditions and resistant to chemicals, UV rays and normal sewer gases

Materials and Standards

- Flexible couplings are made of elastomeric polyvinyl chloride (PVC) for long-lasting performance and durability
- Bactericides and fungicides are added to PVC for extra protection
- All NDS clamps, including the band and housing, are made from series 300 stainless steel, offering corrosion-resistant, rustproof reliability
- NDS Flexible Couplings have listings from the following code agencies: ICC (International Code Council), CSA (Canadian Standards Association) and IAPMO (International Association of Plumbing and Mechanical Officials)

Installation

- Clamps install easily with a screwdriver, 5/16" nut driver or socket to 60 inch-lbs. pounds torque
- All couplings are marked with size and pipe materials that the coupling will connect, eliminating guesswork on the job

NDS Flexible Coupling Sizing Chart

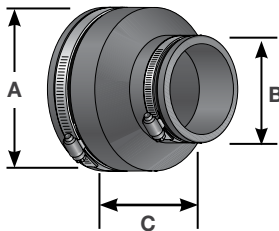

- All dimensions given in inches and mm.
- Couplings available to connect 1-1/4" to 15" pipe.
- 300 Series stainless steel clamps supplied with all couplings.
- All couplings will fit any pipe type within +/- 5% OD on chart.

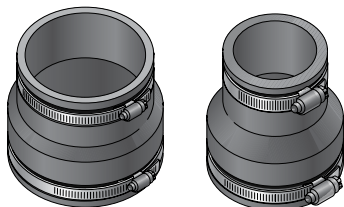

Clay to Clay

| Part No. | A | | B | | C | | Pkg. Qty. | Weight | Product Class |
|----------|--------|-----|--------|-----|--------|-----|-----------|--------|---------------|
| | Inches | mm | Inches | mm | Inches | mm | | | |
| 01-44 | 5.25 | 133 | 5.25 | 133 | 4.00 | 101 | 18 | 1.27 | 45C0 |

Clay to Cast Iron or Plastic

| Part No. | A | | B | | C | | Pkg. Qty. | Weight | Product Class |
|----------|--------------------|-----|--------|-----|--------|-----|-----------|--------|---------------|
| | Inches | mm | Inches | mm | Inches | mm | | | |
| 02-43 | 5.25 | 133 | 3.38 | 85 | 4.00 | 101 | 36 | 1.25 | 45C0 |
| 02-44 | 5.25 | 133 | 4.38 | 111 | 4.00 | 101 | 24 | 1.04 | 45C0 |
| 02-55 | USE PART NO. 56-65 | | | | | | | | |
| 02-64 | 7.38 | 187 | 4.38 | 111 | 6.00 | 152 | 12 | 2.50 | 45C0 |
| 02-66 | 7.38 | 187 | 6.38 | 162 | 6.00 | 152 | 18 | 2.38 | 45C0 |
| 02-88 | 9.65 | 245 | 8.50 | 215 | 6.00 | 152 | 6 | 3.16 | 45C0 |
| 02-1010 | 11.80 | 299 | 10.60 | 269 | 6.00 | 152 | 3 | 4.00 | 45C0 |
| 02-1212 | 14.38 | 365 | 12.60 | 320 | 6.00 | 152 | 5 | 5.20 | 45C0 |
| 02-1515 | 17.85 | 453 | 15.40 | 391 | 6.00 | 152 | 5 | 6.00 | 45C0 |

Concrete to Cast Iron or Plastic

| Part No. | A | | B | | C | | Pkg. Qty. | Weight | Product Class |
|----------|--------|-----|--------|-----|--------|-----|-----------|--------|---------------|
| | Inches | mm | Inches | mm | Inches | mm | | | |
| 06-44 | 5.62 | 142 | 4.38 | 111 | 4.00 | 101 | 18 | 1.66 | 45C0 |
| 06-64 | 7.80 | 198 | 4.38 | 111 | 6.00 | 152 | 12 | 2.41 | 45C0 |
| 06-66 | 7.80 | 198 | 6.38 | 162 | 6.00 | 152 | 12 | 2.58 | 45C0 |
| 06-88 | 10.25 | 260 | 8.50 | 215 | 6.00 | 152 | 6 | 3.33 | 45C0 |

NDS FLEXIBLE COUPLINGS AND CONNECTORS

NDS Flexible Coupling Sizing Chart

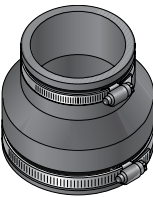
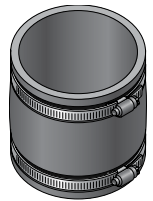
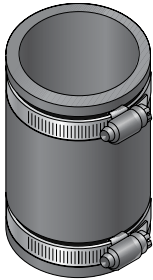

Asbestos Cement, Fibre or Ductile Iron to Cast Iron or Plastic

| Part No. | A | | B | | C | | Pkg. Qty. | Weight | Product Class |
|----------|--------|-----|--------|-----|--------|-----|-----------|--------|---------------|
| | Inches | mm | Inches | mm | Inches | mm | | | |
| 51-44 | 4.75 | 120 | 4.38 | 111 | 4.00 | 101 | 24 | 1.08 | 45CO |
| 51-66 | 7.00 | 177 | 6.38 | 162 | 6.00 | 152 | 15 | 2.73 | 45CO |

Cast Iron, Plastic, Copper, Steel or Lead to Cast Iron, Plastic, Copper, Steel or Lead

| Part No. | A | | B | | C | | Pkg. Qty. | Weight | Product Class |
|------------|--------|-----|--------|-----|--------|-----|-----------|--------|---------------|
| | Inches | mm | Inches | mm | Inches | mm | | | |
| 56-125 | 1.65 | 40 | 1.65 | 40 | 4.00 | 101 | 90 | 0.36 | 45CO |
| 56-150/125 | 1.90 | 48 | 1.65 | 40 | 4.00 | 101 | 75 | 0.41 | 45CO |
| 56-150 | 1.90 | 48 | 1.90 | 48 | 4.00 | 101 | 75 | 0.41 | 45CO |
| 56-2150 | 2.40 | 60 | 1.90 | 48 | 4.00 | 101 | 54 | 0.51 | 45CO |
| 56-22 | 2.40 | 60 | 2.40 | 60 | 4.00 | 101 | 54 | 0.50 | 45CO |
| 56-32 | 3.38 | 85 | 2.40 | 60 | 4.00 | 101 | 45 | 0.71 | 45CO |
| 56-33 | 3.38 | 85 | 3.38 | 85 | 4.00 | 101 | 45 | 0.75 | 45CO |
| 56-42 | 4.38 | 111 | 2.40 | 60 | 4.00 | 101 | 30 | 0.93 | 45CO |
| 56-E43 | 4.38 | 111 | 3.38 | 85 | 4.00 | 101 | 24 | 1.37 | 45CO |
| 56-43 | 4.38 | 111 | 3.38 | 85 | 4.00 | 101 | 25 | 1.08 | 45CO |
| 56-44 | 4.42 | 112 | 4.42 | 112 | 4.00 | 101 | 24 | 1.66 | 45CO |
| 56-44W | 4.42 | 112 | 4.42 | 112 | 4.00 | 101 | 24 | 1.17 | 45CO |
| 56-55 | 5.62 | 142 | 5.62 | 142 | 4.00 | 101 | 18 | 1.38 | 45CO |
| 56-63 | 6.38 | 162 | 3.38 | 85 | 6.00 | 152 | 12 | 1.67 | 45CO |
| 56-E64 | 6.38 | 162 | 4.38 | 111 | 6.00 | 152 | 10 | 2.20 | 45CO |
| 56-64 | 6.38 | 162 | 4.38 | 111 | 6.00 | 152 | 12 | 2.16 | 45CO |
| 56-66 | 6.38 | 162 | 6.38 | 162 | 6.00 | 152 | 15 | 2.13 | 45CO |
| 56-86 | 8.50 | 215 | 6.38 | 162 | 6.00 | 152 | 8 | 3.37 | 45CO |
| 56-88 | 8.50 | 215 | 8.50 | 215 | 6.00 | 152 | 12 | 3.50 | 45CO |
| 56-1010 | 10.60 | 269 | 10.60 | 269 | 7.00 | 178 | 2 | 6.00 | 45CO |
| 56-1212 | 12.83 | 326 | 12.83 | 326 | 6.00 | 152 | 3 | 5.00 | 45CO |

NDS FLEXIBLE COUPLING SIZING CHART

Drain and Trap Connectors

NDS Drain & Trap Connectors are ideal for new installation, alterations and repairs. These connectors offer a quick, low-cost alternative to gluing or soldering and eliminate the need for special tools or threading. Simply place the ends over the pipes and tighten the stainless steel clamps.

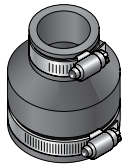

| Part No. | Description | Color | Pkg. Qty. | Wt. Ea. (lbs.) | Product Class |
|------------|---|-------|-----------|----------------|---------------|
| 57-125 | 1-1/4" or 1-1/2" Drain Piping x 1-1/4" or 1-1/2" Drain Piping | Black | 180 | 0.17 | 45CO |
| 57-125/125 | 1-1/4" DWV or 1-1/2" Copper x 1-1/4" or 1-1/2" Drain Piping | Black | 140 | 0.22 | 45CO |
| 57-150/125 | 1-1/2" DWV or 1-1/2" Copper x 1-1/4" or 1-1/2" Drain Piping | Black | 120 | 0.25 | 45CO |

Large Diameter Couplings

Large Diameter Couplings are available through NDS. The large couplings are engineered for use with all the common pipe material: clay, concrete, cast iron, plastic, fiberglass, ductile iron and asbestos/cement. When ordering please remember to provide the exact O.D. size in inches for both pipes. A difference of 6" between the two pipe O.D. sizes cannot be made. Please call for details 1-800-726-1994.

Expansion Joints

NDS Flexible Expansion Joints have a one-piece design which allows for the thermal contraction and expansion of drain, waste and vent. These couplings are maintenance free and rustproof. They are secured by series 300 stainless steel clamps. NDS expansion joints are made of tough elastomeric polyvinyl chloride (PVC). They are strong and resilient. Available in 2" and 3" sizes.

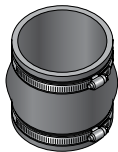
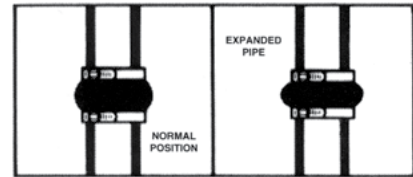

| Part No. | Description | Color | Pkg. Qty. | Wt. Ea. (lbs.) | Product Class |
|----------|---------------------|-------|-----------|----------------|---------------|
| XJ3 | 3" Expansion Joints | Black | 24 | 0.67 | 45CO |

Clamps for Flexible Couplings

| CLAMP MIN. & MAX. DIAMETERS & OVERALL LENGTH | | | | | | | |
|--|-----------|-----------|---------|-----------------|--------|-----------|---------------|
| Part No. | Max. Dia. | Min. Dia. | Length | Color | Weight | Pkg. Qty. | Product Class |
| 33H020 CLAMP | 1.75" | .75" | 6-1/2" | Stainless Steel | 0.05 | 500 | 45CO |
| 33H032 CLAMP | 2.50" | 1.00" | 8-3/4" | Stainless Steel | 0.05 | 400 | 45CO |
| 33H040 CLAMP | 3.00" | 2.06" | 10-3/8" | Stainless Steel | 0.05 | 400 | 45CO |
| 33H056 CLAMP | 4.00" | 1.00" | 13-1/2" | Stainless Steel | 0.10 | 300 | 45CO |
| 33H088 CLAMP | 6.00" | 2.00" | 19-3/4" | Stainless Steel | 0.10 | 200 | 45CO |
| 33H116 CLAMP | 7.75" | 1.75" | 25" | Stainless Steel | 0.10 | 100 | 45CO |
| 33H164 CLAMP | 10.75" | 1.75" | 34-5/8" | Stainless Steel | 0.15 | 100 | 45CO |
| 33H188 CLAMP | 12.25" | 6.25" | 39-1/2" | Stainless Steel | 0.15 | 100 | 45CO |
| 33H212 CLAMP | 13.75" | 11.75" | 44" | Stainless Steel | 0.20 | 100 | 45CO |
| 33H250 CLAMP | 12.62" | 8.75" | 40-1/2" | Stainless Steel | 0.25 | 100 | 45CO |
| 33S248 CLAMP | 16" | 3.625" | 51-1/2" | Stainless Steel | 0.25 | 100 | 45FS |

NDS CONNECTORS AND O-RINGS

NDS Connectors for sewer pipe joints and drain waste & vent piping allow several points of seal between most types of sockets, hubs, bells and spigots. NDS Connectors are donut-shaped rings made of tough elastomeric polyvinyl chloride (PVC) and are available in a range of sizes up to 6". They install quickly and easily and offer the dimensional flexibility that ensures leakproof seals. They are also resistant to chemicals, fungus growth and normal sewer gases due to the inert nature and physical properties of the material. NDS O-Rings provide a quick and easy connection between most 4" house pipes and 6" sewer pipes. *NOTE: Connectors may not perform as intended due to improper or insufficient description of the pipes being connected or changes in pipe dimensions or design by the various manufacturers.*

SV Cast Iron Connectors



| Part No. | Description | Color | Pkg. Qty. | Wt. Ea. (lbs.) | Product Class |
|----------|---|-------|-----------|----------------|---------------|
| 44U-405 | 4" x 4" SV HUB x Sch40 (DWW) or Sch40 Steel or C.I.XH | Black | 35 | 0.48 | 45C0 |

Asbestos Cement Connectors – John Manville and Capco



| Part No. | Description | Color | Pkg. Qty. | Wt. Ea. (lbs.) | Product Class |
|----------|---|-------|-----------|----------------|---------------|
| 44U-405 | 4" x 4" SW Duplex Adapter x C.I.XH or ABS/PVC DWW | Black | 35 | 0.48 | 45C0 |

Cleanout or Test Caps

NDS Cleanout or Test Caps are designed to fit drain, waste and vent pipe materials. The 1-1/2" thru 4" NDS Caps are designed to fit schedule 40 nominal pipe sizes. The 6" thru 10" NDS Caps are designed to fit SDR 35 nominal pipe sizes. Our caps offer a quick and easy way to cap pipe ends and cleanouts. The reinforced convex face allows the cap to withstand greater pressure for testing and minimize ballooning. They are also low cost and reusable.

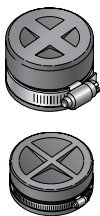

| Part No. | Description | Color | Pkg. Qty. | Wt. Ea. (lbs.) | Product Calss | Product Class |
|----------|-------------|-------|-----------|----------------|---------------|---------------|
| 150 | 1-1/2" Cap | Black | 100 | 0.19 | 45CP | IAMPO Listed. |
| 102 | 2" Cap | Black | 100 | 0.21 | 45CP | |
| 103 | 3" Cap | Black | 50 | 0.90 | 45CP | |
| 104 | 4" Cap | Black | 50 | 0.44 | 45CP | |
| 105 | 5" Cap | Black | 24 | 0.87 | 45CP | |
| 106 | 6" Cap | Black | 24 | 0.95 | 45CP | |
| 108 | 8" Cap | Black | 16 | 1.81 | 45CP | |

CONCRETE MANHOLE COVER ADAPTERS

NDS Concrete Manhole Cover Adapters are made of elastomeric polyvinyl chloride (PVC) and are available for 4", 6", 8", 10", and 12" pipe. Our adapters help eliminate leaks around pipe entering manhole walls and are flexible enough to permit some lateral pipe movement without compromising the integrity of the seal. However, NDS does not warrant this product as a positive water seal due to the many varying factors that can influence the product's effectiveness as a positive seal, such as: field conditions, quality of grout, workmanship and high-ground water tables.

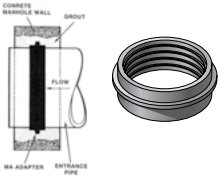

| Part No. | Description | Color | Pkg. Qty. | Wt. Ea. (lbs.) | Product Class |
|----------|---------------------|-------|-----------|----------------|---------------|
| 4MA | 4" Manhole Adapter | Black | 24 | 1.00 | 45C0 |
| 6MA | 6" Manhole Adapter | Black | 24 | 0.62 | 45C0 |
| 8MA | 8" Manhole Adapter | Black | 14 | 1.00 | 45C0 |
| 12MA | 12" Manhole Adapter | Black | 6 | 1.50 | 45C0 |

NDS FLEXIBLE SADDLES

For superior durability and flexibility, saddle up. A breakthrough in saddle design, the patented NDS Flexible Saddle demonstrates superior flexibility in more than one way. The saddle's elastomeric construction allows a single description to securely fit 6" sewer main pipe diameters and up. The saddle's flexibility eliminates the need for a large inventory of rigid PVC saddles of various descriptions.

NDS Flexible Saddle offers the following product benefits:

- Two configurations, a "Tee" and a "Wye" are available in 4" or 6" inlet descriptions
- Elastomeric construction provides maximum strength and flexibility
- Saddle design will accommodate polyethylene pipe used in slip lining sewer systems
- Inlet range from SCH-40 down to SDR-35 includes standard weight soil pipe
- Stainless steel series 300 clamps ensure tight seal
- Steel-reinforced edges prevent distortion when torque is applied to clamps
- Durable design and low unit price make the Flexible Saddle economical and environmentally wise
- Available saddle blanket, attached to pipe prior to saddle installation, will mend imperfections and cracks on clay pipe taps

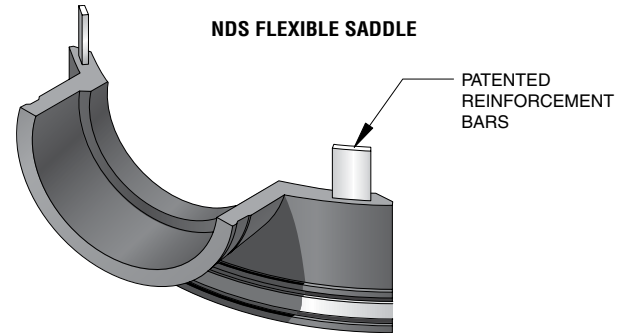

NDS Flexible Saddles

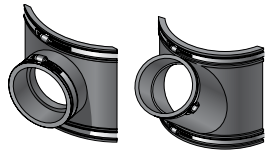

| Part No. | Description | Color | Pkg. Qty. | Wt. Ea. (lbs.) | Product Class |
|----------|----------------------------|-------|-----------|----------------|---------------|
| 4T/C | 4" Tees with Clamps | Black | 12 | 3.16 | 45FS |
| 4T/WOC | 4" Tees without Clamps | Black | 12 | 2.66 | 45FS |
| 4Y/C | 4" Wyes with Clamps | Black | 6 | 7.66 | 45FS |
| 4Y/WOC | 4" Wyes without Clamps | Black | 6 | 7.12 | 45FS |
| 6T/C | 6" Tees with Clamps | Black | 6 | 6.50 | 45FS |
| 6T/WOC | 6" Tees without Clamps | Black | 6 | 6.0 | 45FS |
| 6Y/C | 6" Wyes with Clamps | Black | 4 | 9.9 | 45FS |
| 6Y/WOC | 6" Flex Wye without Clamps | Black | 4 | 11.75 | 45FS |

Saddle Clamps

| Part No. | Description | Color | Pkg. Qty. | Wt. Ea. (lbs.) | Product Class |
|--------------|-----------------------------|-----------------|-----------|----------------|---------------|
| 33S248 CLAMP | Clamp for Flexible Coupling | Stainless Steel | 100 | 0.25 | 45FS |

ASTM Material Specification

| Test | NDS Material | ASTM Test Material |
|-----------------------------|--|-------------------------------------|
| Chemical Resistance | | |
| 1N sulfuric acid | No weight loss | D543 |
| 1N hydrochloric acid | No weight loss | |
| Tensile Strength Elongation | 1000 psi (7Mpa) min. 200% min. elongation @ break | D412 Die "C" |
| Duration Hardness | Shore durometer 50 min. to 75 max. | D2240 |
| Compression Set | 30% max. of original deflection | D395, Method B Type 2 |
| Water Absorption | 5% max. | D471, immersed 7 days @158 Method A |
| Ozone Resistance | No visible cracking under 7x magnification | D1149, D518 Method A |
| Oven Aging | 75% min. of original tensile strength 65% min. of original elongation | D573 (158°F for 70 hours) |
| Cold Brittleness | Cold brittleness was determined to be -43°C | D476 |
| Tear Strength | 125 lbs./in. | D624 Die "C" |

CLAMPS

Stainless Steel Pinch "Crimp" Hose Clamps



| Part No. | Description | Pkg. Qty. | Case. Qty. | Product Class |
|---------------|----------------------------|-----------|------------|---------------|
| NC-155000-003 | 133R 1/2" SS Crimp Clamp | 100 | 100 | 45PC |
| NC-155000-008 | 157R 3/8" SS Crimp Clamp | 100 | 100 | 45PC |
| NC-155000-009 | 170R SS Crimp Clamp | 100 | 100 | 45PC |
| NC-155000-010 | 185R 23/32" SS Crimp Clamp | 100 | 3000 | 45PC |
| NC-155000-011 | 198R 5/8" SS Crimp Clamp | 100 | 3000 | 45PC |
| NC-155000-012 | 210R 13/16" SS Crimp Clamp | 100 | 2500 | 45PC |
| NC-155000-013 | 226R SS Crimp Clamp | 100 | 100 | 45PC |
| NC-155000-015 | 256R 3/4" SS Crimp Clamp | 100 | 100 | 45PC |
| NC-155000-016 | 271R 3/4" SS Crimp Clamp | 100 | 2000 | 45PC |
| NC-155000-017 | 286R SS Crimp Clamp | 100 | 100 | 45PC |
| NC-155000-019 | 316R 15/16" SS Crimp Clamp | 100 | 2000 | 45PC |
| NC-155000-020 | 331R 1" SS Crimp Clamp | 100 | 2000 | 45PC |
| NC-155000-021 | 346R 1-3/8" SS Crimp Clamp | 100 | 1500 | 45PC |
| NC-155000-022 | 361R SS Crimp Clamp | 100 | 1500 | 45PC |
| NC-155000-025 | 396R SS Crimp Clamp | 80 | 100 | 45PC |
| NC-155000-026 | 410R 1-5/8" SS Crimp Clamp | 80 | 100 | 45PC |
| NC-155000-027 | 425R 1-1/4" SS Crimp Clamp | 80 | 1500 | 45PC |
| NC-155000-028 | 440R 1-1/4" SS Crimp Clamp | 80 | 100 | 45PC |
| NC-155000-031 | 485R 1-7/8" SS Crimp Clamp | 50 | 1500 | 45PC |
| NC-155000-032 | 500R 1-1/2" SS Crimp Clamp | 50 | 100 | 45PC |
| NC-155000-033 | 515R 1-1/2" SS Crimp Clamp | 50 | 100 | 45PC |
| NC-155000-039 | 605R 2-3/8" SS Crimp Clamp | 40 | 100 | 45PC |
| NC-155000-040 | 620R 2 SS Crimp Clamp | 40 | 100 | 45PC |
| NC-155000-042 | 650R 2 SS Crimp Clamp | 30 | 100 | 45PC |

Stainless Steel Pinch Clamp Crimp Tool



| Part No. | Description | Pkg. Qty. | Carton Qty. | Product Class |
|----------|-------------------------|-----------|-------------|---------------|
| NCT-1098 | Standard Jaw Crimp Tool | 1 | 10 | 45PC |

CLAMPS

Worm Drive Hose Clamps



Superior Longevity – 100% stainless steel construction

Added Strength – 4 piece design includes underside plate, Conical arched perforated slots

Smoother Worm Drive – Buttressed threads and more threads per screw

Primarily use to tighten around and secure pliable (soft) hose or tube

Plumbing: Connections for dishwashers, garbage disposals, water softeners, air conditioning

Irrigation: Secure poly tubing, stabilize risers to stake

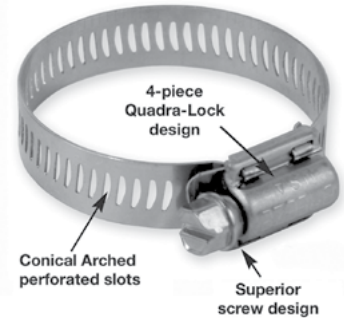

| Part No. | Description | Pkg. Qty. | Case. Qty. | Product Class |
|----------|---|-----------|------------|---------------|
| 3604 | SAE 6, 5/16" Band Width, Effective Diameter Range: 7/16" Min., 25/32" Max. | 10 | 200 | 45HC |
| 3606 | SAE 8, 5/16" Band Width, Effective Diameter Range: 1/2" Min., 29/32" Max. | 10 | 200 | 45HC |
| 64006H | SAE 6, 1/2" Band Width, Effective Diameter Range: 7/16" Min., 25/32" Max. | 10 | 200 | 45HC |
| 64008H | SAE 8, 1/2" Band Width, Effective Diameter Range: 1/2" Min., 29/32" Max. | 10 | 200 | 45HC |
| 64010H | SAE 10, 1/2" Band Width, Effective Diameter Range: 9/16" Min., 1-1/8" Max. | 10 | 500 | 45HC |
| 64012H | SAE 12, 1/2" Band Width, Effective Diameter Range: 11/16" Min., 1-1/4" Max. | 10 | 500 | 45HC |
| 64016H | SAE 16, 1/2" Band Width, Effective Diameter Range: 13/16" Min., 1-1/2" Max. | 10 | 500 | 45HC |
| 64020H | SAE 20, 1/2" Band Width, Effective Diameter Range: 13/16" Min., 1-3/4" Max. | 10 | 500 | 45HC |
| 64024H | SAE 24, 1/2" Band Width, Effective Diameter Range: 1-1/16" Min., 2" Max. | 10 | 500 | 45HC |
| 64028H | SAE 28, 1/2" Band Width, Effective Diameter Range: 1-5/16" Min., 2-1/4" Max. | 10 | 500 | 45HC |
| 64032H | SAE 32, 1/2" Band Width, Effective Diameter Range: 1-9/16" Min., 2-1/2" Max. | 10 | 500 | 45HC |
| 64036H | SAE 36, 1/2" Band Width, Effective Diameter Range: 1-13/16" Min., 2-3/4" Max. | 10 | 500 | 45HC |
| 64040H | SAE 40, 1/2" Band Width, Effective Diameter Range: 2-1/16" Min., 3" Max. | 10 | 200 | 45HC |
| 64044H | SAE 44, 1/2" Band Width, Effective Diameter Range: 2-5/16" Min., 3-1/4" Max. | 10 | 200 | 45HC |
| 64048H | SAE 48, 1/2" Band Width, Effective Diameter Range: 2-9/16" Min., 3-1/2" Max. | 10 | 200 | 45HC |
| 64052H | SAE 52, 1/2" Band Width, Effective Diameter Range: 2-13/16" Min., 3-3/4" Max. | 10 | 200 | 45HC |
| 64056H | SAE 56, 1/2" Band Width, Effective Diameter Range: 3-1/16" Min., 4" Max. | 10 | 200 | 45HC |
| 64064H | SAE 62, 1/2" Band Width, Effective Diameter Range: 3-9/16" Min., 4-1/2" Max. | 10 | 200 | 45HC |
| 64072H | SAE 72, 1/2" Band Width, Effective Diameter Range: 1-7/8" Min., 5" Max. | 10 | 100 | 45HC |
| 64080H | SAE 80, 1/2" Band Width, Effective Diameter Range: 2-1/2" Min., 5-1/2" Max. | 10 | 100 | 45HC |
| 64088H | SAE 88, 1/2" Band Width, Effective Diameter Range: 3-1/8" Min., 6" Max. | 10 | 100 | 45HC |
| 64096H | SAE 96, 1/2" Band Width, Effective Diameter Range: 3-5/8" Min., 6-1/2" Max. | 10 | 100 | 45HC |
| 64104H | SAE 104, 1/2" Band Width, Effective Diameter Range: 4-1/8" Min., 7" Max. | 10 | 100 | 45HC |

CLAMPS

Worm Drive Hose Clamps (cont.)



| Part No. | Description | Pkg. Qty. | Case. Qty. | Product Class |
|-----------|---|-----------|------------|---------------|
| 200 06 H | SAE 6, 9/16" Band Width, Effective Diameter Range: 7/16" Min., 25/32" Max. | 10 | 200 | 45HC |
| 200 08 H | SAE 8, 9/16" Band Width, Effective Diameter Range: 1/2" Min., 29/32" Max. | 10 | 200 | 45HC |
| 200 10 H | SAE 10, 9/16" Band Width, Effective Diameter Range: 9/16" Min., 1-1/6" Max. | 10 | 500 | 45HC |
| 200 12 H | SAE 12, 9/16" Band Width, Effective Diameter Range: 11/16" Min., 1-1/4" Max. | 10 | 500 | 45HC |
| 200 16 H | SAE 16, 9/16" Band Width, Effective Diameter Range: 13/16" Min., 1-1/2" Max. | 10 | 500 | 45HC |
| 200 20 H | SAE 20, 9/16" Band Width, Effective Diameter Range: 13/16" Min., 1-3/4" Max. | 10 | 500 | 45HC |
| 200 24 H | SAE 24, 9/16" Band Width, Effective Diameter Range: 1-1/16" Min., 2" Max. | 10 | 500 | 45HC |
| 200 28 H | SAE 28, 9/16" Band Width, Effective Diameter Range: 1-5/16" Min., 2-1/4" Max. | 10 | 500 | 45HC |
| 200 32 H | SAE 32, 9/16" Band Width, Effective Diameter Range: 1-9/16" Min., 2-1/2" Max. | 10 | 500 | 45HC |
| 200 36 H | SAE 36, 9/16" Band Width, Effective Diameter Range: 1-13/16" Min., 2-3/4" Max. | 10 | 500 | 45HC |
| 200 40 H | SAE 40, 9/16" Band Width, Effective Diameter Range: 2-1/16" Min., 3" Max. | 10 | 200 | 45HC |
| 200 44 H | SAE 44, 9/16" Band Width, Effective Diameter Range: 2-5/16" Min., 3-1/4" Max. | 10 | 200 | 45HC |
| 200 48 H | SAE 48, 9/16" Band Width, Effective Diameter Range: 2-9/16" Min., 3-1/2" Max. | 10 | 200 | 45HC |
| 200 52 H | SAE 52, 9/16" Band Width, Effective Diameter Range: 2-13/16" Min., 3-3/4" Max. | 10 | 200 | 45HC |
| 200 56 H | SAE 56, 9/16" Band Width, Effective Diameter Range: 3-1/16" Min., 4" Max. | 10 | 200 | 45HC |
| 200 64 H | SAE 62, 9/16" Band Width, Effective Diameter Range: 3-9/16" Min., 4-1/2" Max. | 10 | 200 | 45HC |
| 200 72 H | SAE 72, 9/16" Band Width, Effective Diameter Range: 1-7/8" Min., 5" Max. | 10 | 100 | 45HC |
| 200 80 H | SAE 80, 9/16" Band Width, Effective Diameter Range: 2-1/2" Min., 5-1/2" Max. | 10 | 100 | 45HC |
| 200 88 H | SAE 88, 9/16" Band Width, Effective Diameter Range: 3-1/8" Min., 6" Max. | 10 | 100 | 45HC |
| 200 96 H | SAE 96, 9/16" Band Width, Effective Diameter Range: 3-5/8" Min., 6-1/2" Max. | 10 | 100 | 45HC |
| 200 104 H | SAE 104, 9/16" Band Width, Effective Diameter Range: 4-1/8" Min., 7" Max. | 10 | 100 | 45HC |
| 200 128 H | SAE 128, 9/16" Band Width, Effective Diameter Range: 5-5/8" Min., 8-1/2" Max. | 10 | 100 | 45HC |
| 200 152 H | SAE 152, 9/16" Band Width, Effective Diameter Range: 7-1/8" Min., 10" Max. | 10 | 100 | 45HC |
| 200 188 H | SAE 188, 9/16" Band Width, Effective Diameter Range: 9-3/8" Min., 12-1/4" Max. | 10 | 100 | 45HC |
| 200 212 H | SAE 212, 9/16" Band Width, Effective Diameter Range: 10-7/8" Min., 13-3/4" Max. | 10 | 100 | 45HC |

CLAMPS

Clamp-All® Hi-Torq Hubless Pipe Couplings



| Part No. | Size | Description | Carton Qty. | Weight (lbs.) | Product Class |
|----------|--------|-----------------------|-------------|---------------|---------------|
| 81015 | 1-1/2" | Hi-Torq 80 Couplings | 80 | 34 | 45CA |
| 81020 | 2" | Hi-Torq 80 Couplings | 64 | 31 | 45CA |
| 81030 | 3" | Hi-Torq 80 Couplings | 36 | 23 | 45CA |
| 81040 | 4" | Hi-Torq 80 Couplings | 36 | 28 | 45CA |
| 81050 | 5" | Hi-Torq 80 Couplings | 12 | 17 | 45CA |
| 81060 | 6" | Hi-Torq 80 Couplings | 12 | 20 | 45CA |
| 81080 | 8" | Hi-Torq 80 Couplings | 8 | 16 | 45CA |
| 81100 | 10" | Hi-Torq 80 Couplings | 8 | 21 | 45CA |
| 10015 | 1-1/2" | Hi-Torq 125 Couplings | 80 | 41 | 45CA |
| 10020 | 2" | Hi-Torq 125 Couplings | 64 | 38 | 45CA |
| 10030 | 3" | Hi-Torq 125 Couplings | 36 | 28 | 45CA |
| 10040 | 4" | Hi-Torq 125 Couplings | 36 | 34 | 45CA |
| 10050 | 5" | Hi-Torq 125 Couplings | 12 | 21 | 45CA |
| 10060 | 6" | Hi-Torq 125 Couplings | 12 | 24 | 45CA |
| 10080 | 8" | Hi-Torq 125 Couplings | 8 | 22 | 45CA |
| 10100 | 10" | Hi-Torq 125 Couplings | 8 | 25 | 45CA |
| 10120 | 12" | Hi-Torq 125 Couplings | 8 | 34 | 45CA |
| 10150 | 15" | Hi-Torq 125 Couplings | 4 | 23 | 45CA |

Clamp-All® Tools



| Part No. | Size | Description | Carton Qty. | Product Class |
|----------|------|--------------------|-------------|---------------|
| 99080 | 80 | Hi-Torq 80 wrench | 1 | 45CA |
| 99125 | 125 | Hi-Torq 125 wrench | 1 | 45CA |

Snap-All® Increaser/Reducer Transition Bushings



| Part No. | Description | Carton Qty. | Weight (lbs.) | Product Class |
|----------|--------------------------|-------------|---------------|---------------|
| 31575 | 1-1/2" x 3/4" CU | 12/144 | 29 | 45CA |
| 30151 | 1-1/2" x 1" CU | 12/144 | 23 | 45CA |
| 31512 | 1-1/2" x 1-1/4" CU | 12/144 | 15 | 45CA |
| 31515 | 1-1/2" x 1-1/2" CU | 12/144 | 12 | 45CA |
| 30215 | 2" x 1-1/2" CU | 6/72 | 15 | 45CA |
| 20215 | 2" x 1-1/2" CI, STL, PVC | 6/72 | 10 | 45CA |
| 30022 | 2" x 2" CU, XH | 6/72 | 7 | 45CA |
| 30032 | 3" x 2" CU | 9/108 | 50 | 45CA |
| 20032 | 3" x 2" CI, STL, PVC | 9/108 | 44 | 45CA |
| 20325 | 3" x 2-1/2" CI, STL, PVC | 9/108 | 38 | 45CA |
| 30033 | 3" x 3" CU, XH | 9/108 | 15 | 45CA |
| 30043 | 4" x 3" CU | 5/60 | 40 | 45CA |
| 20043 | 4" x 3" CI, STL, PVC | 5/60 | 34 | 45CA |
| 30044 | 4" x 4" CU, XH | 5/60 | 13 | 45CA |
| 20054 | 5" x 4" CI, STL, PVC | 4/48 | 40 | 45CA |
| 20064 | 6" x 4" CI, STL, PVC | 1/12 | 24 | 45CA |
| 20065 | 6" x 5" CI, STL, PVC | 1/12 | 14 | 45CA |
| 20086 | 8" x 6" CI, STL, PVC | 1/12 | 34 | 45CA |

FITTINGS & CLAMPS PRODUCTS INDEX

| Part No. | Page | Part No. | Page | Part No. | Page | Part No. | Page | Part No. | Page |
|----------|----------|--------------|------|------------|----------|--------------|----------|---------------|------|
| 01-44 | 180 | 6P07S | 173 | 57-125 | 182 | 675 | 178, 179 | 64088H | 187 |
| 02-43 | 180 | 6P08 | 174 | 57-125/125 | 182 | 675P | 178, 179 | 64096H | 187 |
| 02-44 | 180 | 6P09 | 174 | 57-150/125 | 182 | 822-040-16 | 179 | 64104H | 187 |
| 02-55 | 180 | 6T/C | 185 | 61P0 | 172 | 822-060-16 | 179 | 81015 | 189 |
| 02-64 | 180 | 6T/WOC | 185 | 61P8 | 174 | 822-080-16 | 179 | 81020 | 189 |
| 02-66 | 180 | 6Y/C | 185 | 64P01 | 172 | 880-136 | 179 | 81030 | 189 |
| 02-88 | 180 | 6Y/WOC | 185 | 64P08 | 174 | 880-202 | 179 | 81040 | 189 |
| 02-1010 | 180 | 8MA | 184 | 84P01 | 172 | 880-234 | 179 | 81050 | 189 |
| 02-1212 | 180 | 8P01 | 172 | 84P08 | 174 | 880-237 | 179 | 81060 | 189 |
| 02-1515 | 180 | 8P02 | 172 | 86P01 | 172 | 880-253 | 179 | 81080 | 189 |
| 2P41 | 175 | 8P03 | 172 | 86P08 | 174 | 880-259 | 179 | 81100 | 189 |
| 2P42 | 175 | 8P05 | 173 | 102 | 183 | 880-271 | 179 | 99080 | 189 |
| 2P43 | 175 | 8P06 | 174 | 103 | 183 | 880-364 | 179 | 99125 | 189 |
| 3C05 | 177 | 8P07 | 173 | 104 | 183 | 1219 | 179 | 1530202 | 179 |
| 3C06 | 177 | 8P08 | 174 | 105 | 183 | 1220 | 179 | 1530203 | 179 |
| 3P01 | 172 | 8P09 | 174 | 106 | 183 | 3604 | 187 | 1530204 | 179 |
| 3P02 | 172 | 9P03 | 176 | 108 | 183 | 3606 | 187 | 1530302 | 179 |
| 3P03 | 172 | 9P04 | 176 | 150 | 183 | 8051-020-040 | 179 | 1530303 | 179 |
| 3P03ST | 173 | 9P06 | 176 | 200 | 188 | 8051-030-060 | 179 | 1530304 | 179 |
| 3P04 | 173 | 9P07 | 176 | 200 06 H | 188 | 8051-040-080 | 179 | 1530402 | 179 |
| 3P05 | 173 | 9P08 | 176 | 200 10 H | 188 | 8051-060-100 | 179 | 1530403 | 179 |
| 3P05R | 173 | 9P09 | 176 | 200 12 H | 188 | 10015 | 189 | 1530404 | 179 |
| 3P06 | 174 | 9P10 | 176 | 200 16 H | 188 | 10020 | 189 | 1530405 | 179 |
| 3P07 | 173 | 9P11 | 176 | 200 20 H | 188 | 10030 | 189 | 1530602 | 179 |
| 3P08 | 174 | 9P12 | 176 | 200 24 H | 188 | 10040 | 189 | 1530603 | 179 |
| 3P09 | 174 | 9P13 | 176 | 200 28 H | 188 | 10050 | 189 | 1530605 | 179 |
| 3P11 | 174 | 12MA | 184 | 200 32 H | 188 | 10060 | 189 | NC-155000-003 | 186 |
| 3P12 | 175 | 31P0 | 172 | 200 36 H | 188 | 10080 | 189 | NC-155000-008 | 186 |
| 3P15 | 175 | 31P8 | 174 | 200 40 H | 188 | 10100 | 189 | NC-155000-009 | 186 |
| 3P16 | 175 | 31POST | 172 | 200 44 H | 188 | 10120 | 189 | NC-155000-010 | 186 |
| 3P17 | 175 | 33H020 CLAMP | 182 | 200 48 H | 188 | 10150 | 189 | NC-155000-011 | 186 |
| 4C06 | 177 | 33H032 CLAMP | 182 | 200 52 H | 188 | 20032 | 189 | NC-155000-012 | 186 |
| 4C07 | 177 | 33H040 CLAMP | 182 | 200 56 H | 188 | 20043 | 189 | NC-155000-013 | 186 |
| 4MA | 184 | 33H056 CLAMP | 182 | 200 64 H | 188 | 20054 | 189 | NC-155000-015 | 186 |
| 4P01 | 172 | 33H088 CLAMP | 182 | 200 72 H | 188 | 20064 | 189 | NC-155000-016 | 186 |
| 4P1X | 175 | 33H116 CLAMP | 182 | 200 80 H | 188 | 20065 | 189 | NC-155000-017 | 186 |
| 4P02 | 172 | 33H164 CLAMP | 182 | 200 88 H | 188 | 20086 | 189 | NC-155000-019 | 186 |
| 4P03 | 172 | 33H188 CLAMP | 182 | 200 96 H | 188 | 20215 | 189 | NC-155000-020 | 186 |
| 4P03ST | 173 | 33H212 CLAMP | 182 | 200 104 H | 188 | 20325 | 189 | NC-155000-021 | 186 |
| 4P04 | 173 | 33H250 CLAMP | 182 | 200 128 H | 188 | 30022 | 189 | NC-155000-022 | 186 |
| 4P05 | 173 | 33S248 CLAMP | 182 | 200 152 H | 188 | 30032 | 189 | NC-155000-025 | 186 |
| 4P05R | 173 | 41P0 | 172 | 200 188 H | 188 | 30033 | 189 | NC-155000-026 | 186 |
| 4P06 | 174 | 41P8 | 174 | 200 212 H | 188 | 30043 | 189 | NC-155000-027 | 186 |
| 4P07 | 173 | 41POST | 172 | 234CDS | 177 | 30044 | 189 | NC-155000-028 | 186 |
| 4P08 | 174 | 44U-405 | 183 | 275 | 178, 179 | 30151 | 189 | NC-155000-031 | 186 |
| 4P09 | 174 | 51-44 | 181 | 275P | 178, 179 | 30215 | 189 | NC-155000-032 | 186 |
| 4P11 | 174 | 51-66 | 181 | 275PR | 178, 179 | 31512 | 189 | NC-155000-033 | 186 |
| 4PVAF | 171, 175 | 56-22 | 181 | 344CDS | 177 | 31515 | 189 | NC-155000-039 | 186 |
| 4T/C | 185 | 56-32 | 181 | 351 | 177 | 31575 | 189 | NC-155000-040 | 186 |
| 4T/WOC | 185 | 56-33 | 181 | 375 | 178, 179 | 64006H | 187 | NC-155000-042 | 186 |
| 4Y/C | 185 | 56-42 | 181 | 375P | 178, 179 | 64008H | 187 | NCT-1098 | 186 |
| 4Y/WOC | 185 | 56-43 | 181 | 375PR | 178, 179 | 64010H | 187 | WC100 | 176 |
| 06-44 | 180 | 56-44 | 181 | 375R | 178, 179 | 64012H | 187 | WC100G | 176 |
| 06-64 | 180 | 56-55 | 181 | 413P | 174 | 64016H | 187 | WC100T | 176 |
| 06-66 | 180 | 56-63 | 181 | 417P | 172 | 64020H | 187 | XJ3 | 182 |
| 06-88 | 180 | 56-64 | 181 | 451 | 177 | 64024H | 187 | | |
| 6C05 | 177 | 56-66 | 181 | 475 | 178, 179 | 64028H | 187 | | |
| 6C06 | 177 | 56-86 | 181 | 475P | 178, 179 | 64032H | 187 | | |
| 6MA | 184 | 56-88 | 181 | 475PR | 178 | 64036H | 187 | | |
| 6P01 | 172 | 56-125 | 181 | 475R | 178, 179 | 64040H | 187 | | |
| 6P02 | 172 | 56-150 | 181 | 532 | 175 | 64044H | 187 | | |
| 6P03 | 172 | 56-150/125 | 181 | 533 | 175 | 64048H | 187 | | |
| 6P03ST | 173 | 56-1010 | 181 | 575 | 178 | 64052H | 187 | | |
| 6P04 | 173 | 56-1212 | 181 | 575P | 178 | 64056H | 187 | | |
| 6P05 | 173 | 56-2150 | 181 | 613P | 174 | 64064H | 187 | | |
| 6P06 | 174 | 56-E43 | 181 | 650 | 176 | 64072H | 187 | | |
| 6P07 | 173 | 56-E64 | 181 | 651 | 177 | 64080H | 187 | | |



ACCESS BOXES



VALVE BOXES

NDS® valve and meter boxes are proudly manufactured in Lindsay, CA, and span a wide variety of sizes, from 6" round to 17" x 30" rectangular. Available with black, green, purple, gray, and sand covers with designations including irrigation control valve, water, sewer, electric, reclaimed water, cable TV, telephone, and others, all NDS boxes and lids contain UV inhibitors for sustained durability and performance in direct sunlight.

NDS® PRO-SPEC™ SERIES VALVE BOXES – NEXT-GENERATION COMMERCIAL GRADE

The NDS Pro-Spec™ Series line is the next generation of valve boxes, ideal for the specification market. These boxes are engineered with unique corrugated sidewalls that provide added strength to the boxes while reducing material and weight. The Pro-Spec™ Series boxes are the strongest in the NDS offering, and they also come with reinforced lids.

Details

- Corrugated sidewalls provide greater strength
- Specification grade valve boxes for professional applications
- Reinforced covers for heavier loads
- Brass nut on boxes for bolt-down capability

Materials and Standards

- High-impact, high-density, injection-molded structural foam polyethylene construction with a melt index between 10-12
- Overlapping covers prevent dirt and grass from settling in between body and cover
- UV inhibitors prevent discoloration and cracking
- 5-year warranty
- Overlapping and drop-in covers available

NDS® STANDARD SERIES VALVE BOXES

Residential/Commercial Grade

NDS valve, meter and access boxes are offered in a wide range of sizes from the 6-inch round valve box to the 17" x 30" rectangular box. They are available with black, green, purple, gray and sand covers with designations including irrigation control valve, water, sewer, electric, reclaimed water, cable TV, telephone and others.

Details

- Covers are identified with ICV (Irrigation Control Valve) designation, unless otherwise specified
- Overlapping covers prevent dirt and grass from settling between body and cover
- The bayonet twist-on cover ensures easy removal on 6-inch and 10-inch round covers
- 6" Snap cover and body available
- The 10-inch round and all rectangular boxes include a brass nut, so bolts may be easily added for lockdown
- UV inhibitors prevent discoloration and deterioration, such as cracking or blistering

Materials and Standards

- Overlapping and drop-in covers available
- Available in round, oval, and rectangular
- One-piece molded of polyolefin with a melt index between 10-12
- UV inhibitors added to aid in preventing discoloration and cracking

NDS PRO-SPEC™ SERIES VALVE BOXES – NEXT-GENERATION COMMERCIAL GRADE

NDS Pro-Spec™ 10" Round Corrugated Valve Boxes

Specifications: The NDS Pro-Spec™ 10" round body is tapered and has a minimum wall thickness of 0.250". The cover seat area has 8 structural support ribs on the underside of the seat, each with a minimum thickness of 0.250". The bottom of the body has a 0.500" flange. The 10" round cover has an average thickness of 0.300". The valve box has a 3/8" Brass nut for the bolt-down as a standard feature.

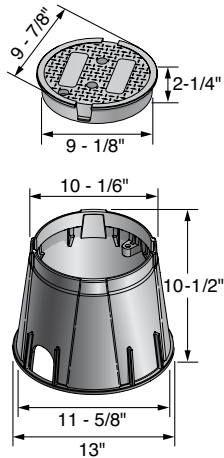

| Part No. | Description | Color (Box/Cover) | Pallet Qty. | Weight Ea. (lbs.) | Product Class |
|------------------------|---|-------------------|-------------|-------------------|---------------|
| Box & Cover | | | | | |
| 311BC | 10" Round Corrugated Box, Round Overlapping Cover - ICV | Black/Green | 132 | 4.6 | 20PR |
| 311BCB | 10" Round Corrugated Box, Round Overlapping Bolt-Down Cover - ICV | Black/Green | 132 | 4.6 | 20PR |
| 311BCBLK | 10" Round Corrugated Box, Round Overlapping Cover - ICV | Black/Black | 132 | 4.6 | 20PR |
| 311BCBW | 10" Round Corrugated Box, Round Overlapping Bolt-Down Cover - Water | Black/Green | 132 | 4.6 | 20PR |
| 311BCR | 10" Round Corrugated Box, Round Overlapping Cover - Reclaimed Water | Black/Purple | 132 | 4.6 | 20PR |
| 311BCS | 10" Round Corrugated Box, Round Overlapping Cover - Sewer | Black/Green | 132 | 4.6 | 20PR |
| 311BCW | 10" Round Corrugated Box, Round Overlapping Cover - Water | Black/Green | 132 | 4.6 | 20PR |
| 312BC | 10" Round Corrugated Box, Round Overlapping Cover - ICV | Green/Green | 132 | 4.6 | 20PR |
| 312BC ELEC | 10" Round Corrugated Box, Round Overlapping Cover - Electric | Gray/Gray | 132 | 4.6 | 20PR |
| 312BCB | 10" Round Corrugated Box, Round Overlapping Bolt-Down Cover - ICV | Green/Green | 132 | 4.4 | 20PR |
| 312BCB ELEC | 10" Round Corrugated Box, Round Overlapping Bolt-Down Cover - Electric | Gray/Gray | 132 | 4.6 | 20PR |
| 312BCBS | 10" Round Corrugated Box, Round Overlapping Bolt-Down Cover - Sewer | Green/Green | 132 | 4.6 | 20PR |
| 312BCRBLK | 10" Round Overlapping Reclaimed Cover | Black/Black | 132 | 4.7 | 20PR |
| 312BCRG | 10" Round Corrugated Box, Round Overlapping Cover - Reclaimed Water | Green/Green | 132 | 4.6 | 20PR |
| 312BCS | 10" Round Corrugated Box, Round Overlapping Cover - Sewer | Green/Green | 132 | 4.6 | 20PR |
| 312BCSAND | 10" Round Corrugated Box, Round Overlapping Cover - ICV | Sand/Sand | 132 | 4.4 | 20PR |
| 312BCW | 10" Round Corrugated Box, Round Overlapping Cover - Water | Green/Green | 132 | 4.6 | 20PR |
| 312PBCBR | 10" Round Corrugated Box, Round Overlapping Bolt-Down Cover - Reclaimed Water | Purple/Purple | 132 | 4.4 | 20PR |
| 312PBCR | 10" Round Corrugated Box, Round Overlapping Cover - Reclaimed Water | Purple/Purple | 132 | 4.4 | 20PR |
| Cover Only | | | | | |
| 311C | 10" Round Overlapping Cover - ICV | Green | 200 | 1.5 | 20PR |
| 311C BLK | 10" Round Overlapping Cover - ICV | Black | 200 | 1.5 | 20PR |
| 311C BRN | 10" Round Overlapping Cover - ICV | Brown | 200 | 1.5 | 20PR |
| 311C ELEC | 10" Round Overlapping Cover - Electric | Gray | 200 | 1.5 | 20PR |
| 311CR | 10" Round Overlapping Cover - Reclaimed Water | Purple | 200 | 1.4 | 20PR |
| 311CRG | 10" Round Overlapping Cover - Reclaimed Water | Green | 200 | 1.5 | 20PR |
| 311CS | 10" Round Overlapping Cover - Sewer | Green | 200 | 1.5 | 20PR |
| 311CSAND | 10" Round Overlapping Cover - ICV | Sand | 200 | 1.4 | 20PR |
| 311CW | 10" Round Overlapping Cover - Water | Black | 200 | 1.5 | 20PR |
| 311CW BLK | 10" Round Overlapping Cover - Water | Green | 200 | 1.5 | 20PR |
| Box Only | | | | | |
| 311B | 10" Round Corrugated Box | Black | 132 | 3 | 20PR |
| 312B | 10" Round Corrugated Box | Green | 132 | 3 | 20PR |
| 312PB | 10" Round Corrugated Box | Purple | 132 | 3 | 20PR |
| 113BB | 2-1/2" x 3/8" SS Bolt | Steel | n/a | 0.1 | 20NM |

NDS PRO-SPEC™ SERIES VALVE BOXES – NEXT-GENERATION COMMERCIAL GRADE

NDS Pro-Spec™ 14" x 19" Rectangular Valve Boxes

Specifications: The NDS Pro-Spec™ 14" x 19" body is tapered and has a minimum wall thickness of 0.187". The body has a double wall at the top cover seat area with a minimum thickness of 0.200". The cover seat area has 18 structural support ribs on the underside of the seat, each with a minimum thickness of 0.200". The bottom of the body has a 0.500" flange. The 14" x 19" cover has an average thickness of 0.200". The valve box has a 3/8" Brass nut for the bolt-down as a standard feature.

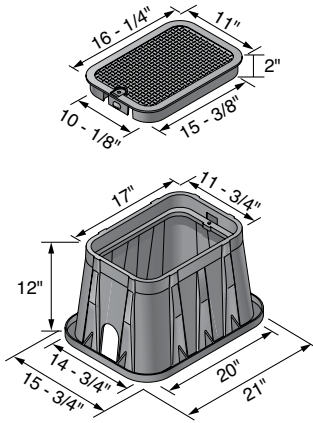

| Part No. | Description | Color (Box/Cover) | Pallet Qty. | Weight Ea. (lbs.) | Product Class |
|------------------------|---|-------------------|-------------|-------------------|---------------|
| Box & Cover | | | | | |
| 313BC | 14" x 19" Box, Overlapping Cover - ICV | Black/Green | 84 | 8.4 | 20PR |
| 313BCB | 14" x 19" Corrugated Box, Overlapping Bolt-Down Cover - ICV | Black/Green | 84 | 8.5 | 20PR |
| 313BCBBLK | 14" x 19" Corrugated Box, Overlapping Bolt-Down Cover - ICV | Black/Black | 84 | 8.5 | 20PR |
| 313BCBR | 14" x 19" Corrugated Box, Overlapping Bolt-Down Cover - Reclaimed Water | Black/Purple | 84 | 8.5 | 20PR |
| 313BCBRBLK | 14" x 19" Corrugated Box, Overlapping Bolt-Down Cover - Reclaimed Water | Black/Black | 84 | 8.5 | 20PR |
| 313BCBRG | 14" x 19" Corrugated Box, Overlapping Bolt-Down Cover - Reclaimed Water | Black/Green | 84 | 8.5 | 20PR |
| 313BCBS | 14" x 19" Corrugated Box, Overlapping Bolt-Down Cover - Sewer | Black/Green | 84 | 8.5 | 20PR |
| 313BCBW | 14" x 19" Corrugated Box, Overlapping Bolt-Down Cover - Water | Black/Green | 84 | 8.5 | 20PR |
| 313BCBWBLK | 14" x 19" Corrugated Box, Overlapping Bolt-Down Cover - Water | Black/Black | 84 | 8.5 | 20PR |
| 314BC | 14" x 19" Box, Overlapping Cover - ICV | Green/Green | 84 | 8.4 | 20PR |
| 314BC ARNB | 14" x 19" Box, Overlapping Cover - Recycled Water English / Spanish | Black/Black | 84 | 8.4 | 20PR |
| 314BCB | 14" x 19" Corrugated Box, Overlapping Bolt-Down Cover - ICV | Green/Green | 84 | 8.5 | 20PR |
| 314BCB ELEC | 14" x 19" Corrugated Box, Overlapping Bolt-Down Cover - Electric | Gray/Gray | 84 | 8.5 | 20PR |
| 314BCBRG | 14" x 19" Corrugated Box, Overlapping Bolt-Down Cover - Reclaimed Water | Green/Green | 84 | 8.5 | 20PR |
| 314BCBS | 14" x 19" Corrugated Box, Overlapping Bolt-Down Cover - Sewer | Green/Green | 84 | 8.5 | 20PR |
| 314BCBSAND | 14" x 19" Corrugated Box, Overlapping Bolt-Down Cover - ICV | Sand/Sand | 84 | 8.5 | 20PR |
| 314BCBW | 14" x 19" Corrugated Box, Overlapping Bolt-Down Cover - Water | Green/Green | 84 | 8.5 | 20PR |
| 314BCSAND | 14" x 19" Box, Overlapping Cover - ICV | Sand/Sand | 84 | 8.2 | 20PR |
| 314PBCBR | 14" x 19" Corrugated Box, Overlapping Bolt-Down Cover - Reclaimed Water | Purple/Purple | 84 | 8.4 | 20PR |
| 314PBCR | 14" x 19" Box, Overlapping Cover - Reclaimed Water | Purple/Purple | 84 | 7.3 | 20PR |
| Cover Only | | | | | |
| 313C | 14" x 19" Overlapping Cover - ICV | Green | 300 | 2.3 | 20PR |
| 313C ELEC | 14" x 19" Overlapping Cover - Electric | Gray | 300 | 2.3 | 20PR |
| 313CBLK | 14" x 19" Overlapping Cover - ICV | Black | 300 | 2.3 | 20PR |
| 313CBRN | 14" x 19" Overlapping Cover - ICV | Brown | 300 | 2.3 | 20PR |
| 313CG ELEC | 14" x 19" Overlapping Cover - Electric | Green | 300 | 2.3 | 20PR |
| 313CR | 14" x 19" Overlapping Cover - Reclaimed Water | Purple | 300 | 2.3 | 20PR |
| 313CRBLK | 14" x 19" Overlapping Cover - Reclaimed Water | Black | 300 | 2.81 | 20PR |
| 313CRG | 14" x 19" Overlapping Cover - Reclaimed Water | Green | 300 | 2.3 | 20PR |
| 313CSAND | 14" x 19" Overlapping Cover - ICV | Sand | 300 | 2.3 | 20PR |
| 313CW | 14" x 19" Overlapping Cover - Water | Black | 300 | 2.3 | 20PR |
| 314CS | 14" x 19" Overlapping Cover - ICV | Black | 300 | 2.3 | 20PR |
| 314CW | 14" x 19" Overlapping Cover - Water | Green | 300 | 2.3 | 20PR |
| Box Only | | | | | |
| 314B | 14" x 19" Box | Green | 84 | 5 | 20PR |
| 314BBLK | 14" x 19" Valve Box | Black | 84 | 5.41 | 20PR |
| 113BB | 2-1/2" x 3/8" SS Bolt | Steel | n/a | 0.1 | 20NM |

VALVE BOXES

NDS PRO-SPEC™ SERIES VALVE BOXES – NEXT-GENERATION COMMERCIAL GRADE

NDS Pro-Spec™ 13" x 20" Rectangular Valve Boxes

Specifications: The NDS Pro-Spec™ 13" x 20" body is tapered and has a minimum wall thickness of 0.250". The body has a double wall at the top cover seat area with a minimum thickness of 0.250". The cover seat area has 22 structural support ribs on the underside of the seat, each with a minimum thickness of 0.130". The bottom of the body has a 0.500" flange. The 13" x 20" cover has an average thickness of 0.250". The valve box has a 3/8" Brass nut for the bolt-down as a standard feature.

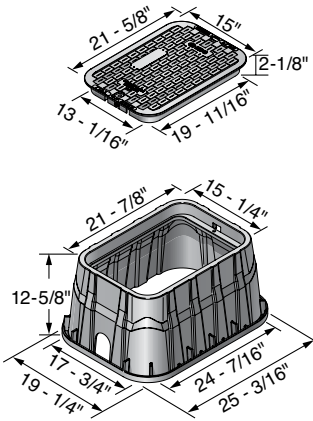

| Part No. | Description | Color (Box/Cover) | Pallet Qty. | Weight Ea. (lbs.) | Product Class |
|------------------------|---|-------------------|-------------|-------------------|---------------|
| Box & Cover | | | | | |
| 317BCB | 13" x 20" Jumbo Corrugated Box, Overlapping Bolt-Down Cover - ICV | Black/Green | 56 | 14.6 | 20PR |
| 317BCBBLK | 13" x 20" Jumbo Corrugated Box, Overlapping Bolt-Down Cover - ICV | Black/Black | 56 | 14.6 | 20PR |
| 317BCBS | 13" x 20" Jumbo Corrugated Box, Overlapping Bolt-Down Cover - Sewer | Black/Green | 56 | 14.6 | 20PR |
| 317BCBW | 13" x 20" Jumbo Corrugated Box, Overlapping Bolt-Down Cover - Water | Black/Black | 56 | 14.6 | 20PR |
| 318BC | 13" x 20" Jumbo Box, Overlapping Cover - ICV | Green/Green | 56 | 14.6 | 20PR |
| 318BCB | 13" x 20" Jumbo Corrugated Box, Overlapping Bolt-Down Cover - ICV | Black/Green | 56 | 14.6 | 20PR |
| 318BCBRBLK | 13" x 20" Jumbo Corrugated Box, Overlapping Bolt-Down Cover - Reclaimed Water | Black/Black | 56 | 14.6 | 20PR |
| 318BCBRG | 13" x 20" Jumbo Corrugated Box, Overlapping Bolt-Down Cover - Reclaimed Water | Green/Green | 56 | 14.6 | 20PR |
| 318BCBS | 13" x 20" Jumbo Corrugated Box, Overlapping Bolt-Down Cover - Sewer | Green/Green | 56 | 14.6 | 20PR |
| 318BCBSAND | 13" x 20" Jumbo Corrugated Box, Overlapping Bolt-Down Cover - ICV | Sand/Sand | 56 | 14.6 | 20PR |
| 318BCBW | 13" x 20" Jumbo Corrugated Box, Overlapping Bolt-Down Cover - Water | Green/Green | 56 | 14.6 | 20PR |
| 318PBCBR | 13" x 20" Jumbo Corrugated Box, Overlapping Bolt-Down Cover Reclaimed Water | Purple/Purple | 56 | 10.7 | 20PR |
| 318PBCR | 13" x 20" Jumbo Box, Overlapping Cover - Reclaimed Water | Purple/Purple | 56 | 14.6 | 20PR |
| Cover Only | | | | | |
| 317C | 13" x 20" Overlapping Cover - ICV | Green | 180 | 5.1 | 20PR |
| 317C BLK | 13" x 20" Overlapping Cover - ICV | Black | 180 | 5.1 | 20PR |
| 317C BRN | 13" x 20" Overlapping Cover - ICV | Brown | 180 | 5.1 | 20PR |
| 317CR | 13" x 20" Overlapping Cover - Reclaimed Water | Purple | 180 | 5 | 20PR |
| 317CS | 13" x 20" Overlapping Cover - Sewer | Green | 180 | 5.1 | 20PR |
| 317CSAND | 13" x 20" Overlapping Cover - ICV | Sand | 180 | 5 | 20PR |
| 317CW | 13" x 20" Overlapping Cover - Water | Black | 180 | 5.1 | 20PR |
| 318CW | 13" x 20" Overlapping Cover - Water | Green | 180 | 5.1 | 20PR |
| Box Only | | | | | |
| 318B | 13" x 20" Jumbo Box | Green | 56 | 9.2 | 20PR |
| 318B BLK | 13" x 20" Jumbo Box | Black | 56 | 9.2 | 20PR |
| 318PB | 13" x 20" Jumbo Box | Purple | 56 | 9.55 | 20PR |
| 113BB | 2-1/2" x 3/8" SS Bolt | Steel | n/a | 0.1 | 20NM |

NDS PRO-SPEC™ SERIES VALVE BOXES – NEXT-GENERATION COMMERCIAL GRADE

NDS Pro-Spec™ 13" x 24" Rectangular Valve Boxes

Specifications: The NDS Pro-Spec™ 13" x 24" body is tapered and has a minimum wall thickness of 0.270". The body has a double wall at the top cover seat area with a minimum thickness of 0.270". The cover seat area has 18 structural support ribs on the underside of the seat, each with a minimum thickness of 0.250". The bottom of the body has a 1.000" flange. The 13" x 24" cover has an average thickness of 0.320". The valve box has a 3/8" Brass nut for the bolt-down as a standard feature.

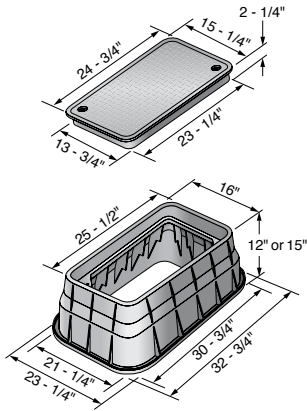

| Part No. | Description | Color (Box/Cover) | Pallet Qty. | Weight Ea. (lbs.) | Product Class |
|------------------------|--|-------------------|-------------|-------------------|---------------|
| Box & Cover | | | | | |
| 321BCB | 13" x 24" x 12" Box, Overlapping Bolt-Down Cover - ICV | Green/Green | 12 | 24 | 20PR |
| 321BCB-BG | 13" x 24" x 12" Box, Overlapping Bolt-Down Cover - ICV | Black/Green | 12 | 24 | 20PR |
| 321BCBS | 13" x 24" x 12" Box, Overlapping Bolt-Down Cover - Sewer | Green/Green | 12 | 24 | 20PR |
| 321BCBW | 13" x 24" x 12" Box, Overlapping Bolt-Down Cover - Water | Green/Green | 12 | 24 | 20PR |
| 322BCB | 13" x 24" x 15" Box, Overlapping Bolt-Down Cover - ICV | Green/Green | 12 | 24 | 20PR |
| 322PBCBR | 13" x 24" x 12" Box, Overlapping Bolt-Down Cover - Reclaimed Water | Purple/Purple | 12 | 24 | 20PR |
| 325BCB | 13" x 24" x 15" Box, Overlapping Bolt-Down Cover - ICV | Black/Green | 12 | 24 | 20PR |
| Cover Only | | | | | |
| 322C | 13" x 24" Overlapping Cover - ICV | Green | 125 | 7 | 20PR |
| 322CS | 13" x 24" Overlapping Cover - Sewer | Green | 125 | 7 | 20PR |
| Box Only | | | | | |
| 321B | 13" x 24" x 12" Box | Green | 12 | 19 | 20PR |
| 322B | 13" x 24" x 15" Box | Green | 12 | 19 | 20PR |
| 325B | 13" x 24" x 15" Box | Black | 12 | 19 | 20PR |
| 121BB | 3/8" x 3" SS Bolt | Steel | n/a | 0.1 | 20NM |

NDS PRO-SPEC™ SERIES VALVE BOXES – NEXT-GENERATION COMMERCIAL GRADE

NDS Pro-Spec™ 17" x 30" Rectangular Valve Boxes

Specifications: The NDS Pro-Spec™ 17" x 30" body is tapered and has a minimum wall thickness of 0.320". The body has a double wall at the top cover seat area with a minimum thickness of 0.320". The cover seat area has 20 structural support ribs on the underside of the seat, each with a minimum thickness of 0.250". The bottom of the body has a 1.000" flange. The 17" x 30" cover has an average thickness of 0.350". The valve box shall have a 3/8" Brass nut for the bolt-down as a standard feature.

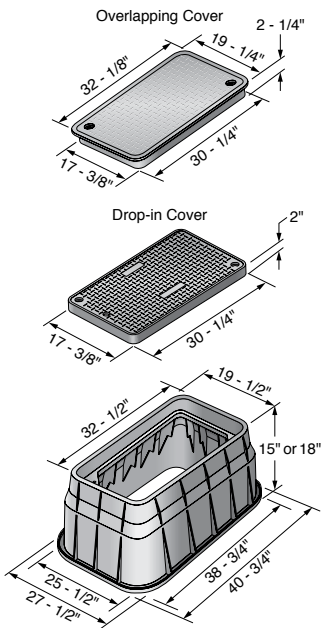

| Part No. | Description | Color (Box/Cover) | Pallet Qty. | Weight Ea. (lbs.) | Product Class |
|------------------------|--|-------------------|-------------|-------------------|---------------|
| Box & Cover | | | | | |
| 324BCB | 17" x 30" x 15" Box, Overlapping Bolt-Down Cover - ICV | Green/Green | 6 | 28 | 20PR |
| 324BCB-BG | 17" x 30" x 15" Box, Overlapping Bolt-Down Cover - ICV | Black/Green | 6 | 28 | 20ND |
| 324BCBS | 17" x 30" x 15" Box, Overlapping Bolt-Down Cover - Sewer | Green/Green | 6 | 28 | 20PR |
| 324BCDB | 17" x 30" x 15" Box, Drop-in Bolt-Down Cover - ICV | Green/Green | 6 | 28 | 20PR |
| 326BCB | 17" x 30" x 18" Box, Overlapping Bolt-Down Cover - ICV | Green/Green | 6 | 39.3 | 20PR |
| 326BCB-BG | 17" x 30" x 18" Box, Overlapping Bolt-Down Cover - ICV | Black/Green | 6 | 41.2 | 20ND |
| 326BCDB | 17" x 30" x 18" Box, Drop-in Bolt-Down Cover - ICV | Green/Green | 6 | 37 | 20PR |
| 326BCDB ELEC | 17" x 30" x 18" Box, Drop-in Cover - Electric | Gray/Gray | 6 | 37.05 | 20PR |
| 326BCDB-BG | 17" x 30" x 18" Box, Drop-in Bolt-Down Cover - ICV | Black/Green | 6 | 37 | 20ND |
| 326BCDBW | 17" x 30" x 18" Box, Drop-in Bolt-Down Cover - Water | Black/Black | 6 | 37 | 20ND |
| 326PBCBR | 17" x 30" x 18" Box, Overlapping Cover - Reclaimed Water | Purple/Purple | 6 | 38 | 20PR |
| Cover Only | | | | | |
| 323C | 17" x 30" Overlapping Cover - ICV | Green | 75 | 11 | 20PR |
| 323CD | 17" x 30" Drop-in Cover - ICV | Green | 75 | 11 | 20PR |
| 323CD ELEC | 17" x 30" Drop-in Cover - Electric | Gray | 75 | 11 | 20PR |
| 323CDW | 17" x 30" Overlapping Cover - Water | Black | 75 | 11 | 20PR |
| 323CR | 17" x 30" Overlapping Cover - Reclaimed Water | Purple | 75 | 11 | 20PR |
| 323CS | 17" x 30" Overlapping Cover - Sewer | Green | 75 | 11 | 20PR |
| Box Only | | | | | |
| 324B | 17" x 30" x 15" Box | Green | 6 | 20 | 20NM |
| 324B BLK | 17" x 30" x 15" Box | Black | 6 | 20 | 20NM |
| 326B | 17" x 30" x 18" Box | Green | 6 | 23 | 20NM |
| 326B BLK | 17" x 30" x 18" Box | Black | 6 | 23 | 20NM |

NDS STANDARD SERIES VALVE BOXES – RESIDENTIAL/COMMERCIAL GRADE

NDS Standard Series 6" Round Valve Boxes

Specifications: The NDS Standard Series 6" round body is tapered and has a minimum wall thickness of 0.200". The body has a double wall at the top cover seat area with a minimum thickness of 0.130". The bottom of the body has a 0.250" flange. The 6" round cover has an average thickness of 0.187".

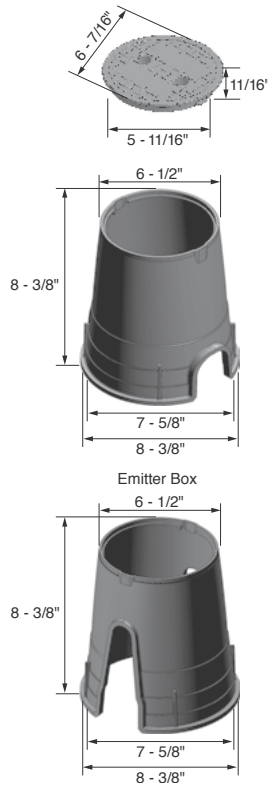

| Part No. | Description | Color (Box/Cover) | Pallet Qty. | Weight Ea. (lbs.) | Product Class |
|------------------------|--|-------------------|-------------|-------------------|---------------|
| Box & Cover | | | | | |
| 107BC | 6" Round Box, Round Overlapping Cover - ICV | Black/Green | 250 | 1.5 | 20ND |
| 107BC ARNB | 6" Round Box, Round Overlapping Cover - Recycled Water English / Spanish | Black/Black | 250 | 1.5 | 20ND |
| 107BC BLK | 6" Round Box, Round Overlapping Cover - ICV | Black/Black | 250 | 1.5 | 20ND |
| 107BC CTN | 6" Round Box, Round Overlapping Cover - ICV - 4 per carton | Black/Green | 108 | 1.05 | 20ND |
| 107BC SAND | 6" Round Box, Round Overlapping Cover - ICV | Sand/Sand | 250 | 1.5 | 20ND |
| 107BC SLV | 6" Round Box, Round Overlapping Cover - ICV - 20 per sleeve | Black/Green | 400 | 1.5 | 20ND |
| 107BCH | 6" Round Snap-in Valve Box, Round Snap-in Overlapping Cover - ICV | Black/Green | 250 | 1.5 | 20ND |
| 107BCR | 6" Round Box, Round Overlapping Cover - Reclaimed Water | Black/Purple | 250 | 1.5 | 20ND |
| 107BCR BLK | 6" Round Box, Round Overlapping Cover - Reclaimed Water | Black/Black | 250 | 1.5 | 20ND |
| 107BCS | 6" Round Box, Round Overlapping Cover - Sewer | Black/Green | 250 | 1.5 | 20NM |
| 107BCW | 6" Round Box, Round Overlapping Solid Plastic Cover - Water | Black/Green | 250 | 1.5 | 20NM |
| 107EBC | 6" Round Emitter Box, Round Overlapping Cover - Emitter Box | Black/Green | 250 | 1.5 | 20ND |
| 107EBCR | 6" Round Emitter Box, Round Overlapping Cover - Emitter Box | Black/Purple | 250 | 1.5 | 20ND |
| 107PBCR | 6" Round Box, Round Overlapping Cover - Reclaimed Water | Purple/Purple | 250 | 1.5 | 20ND |
| 108BC | 6" Round Box, Round Overlapping Cover - ICV | Green/Green | 250 | 1.5 | 20ND |
| 108BCS | 6" Round Box, Round Overlapping Cover - Sewer | Green/Green | 250 | 1.5 | 20ND |
| 108BCW | 6" Round Box, Round Overlapping Cover - Water | Green/Green | 250 | 1.5 | 20ND |
| Cover Only | | | | | |
| 107C | 6" Round Overlapping Cover - ICV | Green | 800 | 0.36 | 20ND |
| 107C BLK | 7" Round Cover ICV | Black | 250 | 1.5 | 20ND |
| 107C BRN | 7" Round Cover ICV | Brown | 250 | 1.5 | 20ND |
| 107C SAND | 6" Round Overlapping Cover - ICV | Sand | 800 | 0.4 | 20ND |
| 107CH | 6" Round Snap-in Overlapping Cover - ICV | Green | 1200 | 0.35 | 20ND |
| 107CR | 6" Round Overlapping Cover - Reclaimed Water | Purple | 800 | 0.4 | 20ND |
| 107CS | 6" Round Overlapping Cover - Sewer | Green | 800 | 0.4 | 20NM |
| 107CW | 6" Round Overlapping Cover - Water | Green | 800 | 0.4 | 20NM |
| Box Only | | | | | |
| 106B | 6" Round Snap-in Valve Box | Black | 250 | 0.9 | 20ND |
| 107B | 6" Round Box | Black | 250 | 1.23 | 20ND |
| 108B | 6" Round Box | Green | 250 | 1.23 | 20ND |

NDS STANDARD SERIES VALVE BOXES – RESIDENTIAL/COMMERCIAL GRADE

NDS Standard Series 10" Round Valve Boxes

Specifications: The NDS Standard Series 10" round body is tapered and has a minimum wall thickness of 0.200". The cover seat area has 6 structural support ribs on the underside of the seat, each with a minimum thickness of 0.250". The bottom of the body has a 0.500" flange. The 10" round cover has an average thickness of 0.250". The valve box has a 5/16" Brass nut for the bolt-down as a standard feature.

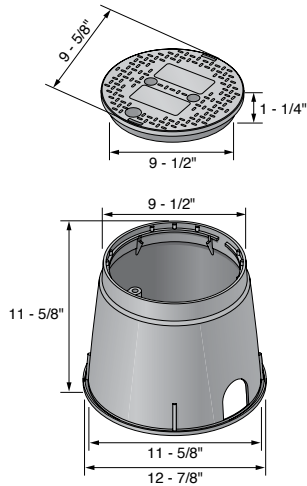

| Part No. | Description | Color (Box/Cover) | Pallet Qty. | Weight Ea. (lbs.) | Product Class |
|------------------------|---|-------------------|-------------|-------------------|---------------|
| Box & Cover | | | | | |
| 111BC | 10" Round Box, Round Overlapping Cover - ICV | Black/Green | 180 | 3 | 20ND |
| 111BC BLK | 10" Round Box, Round Overlapping Cover - ICV | Black/Black | 180 | 3 | 20ND |
| 111BC CTN | 10" Round Box, Round Overlapping Cover - ICV - 4 per carton | Black/Green | 72 | 3.9 | 20ND |
| 111BC SAND | 10" Round Box, Round Overlapping Cover - ICV | Sand/Sand | 180 | 3.2 | 20ND |
| 111BCB | 10" Round Box, Round Overlapping Bolt-Down Cover - ICV | Black/Green | 180 | 3 | 20ND |
| 111BCBW | 10" Round Box, Round Overlapping Bolt-Down Cover - Water | Black/Black | 180 | 3 | 20NM |
| 111BCR | 10" Round Box, Round Overlapping Cover - Reclaimed Water | Black/Purple | 180 | 3 | 20ND |
| 111BCR BLK | 10" Round Box, Round Overlapping Cover - Reclaimed Water | Black/Purple | 180 | 3 | 20ND |
| 111BCS | 10" Round Box, Round Overlapping Cover - Sewer | Black/Green | 180 | 3 | 20NM |
| 111BCW | 10" Round Box, Round Overlapping Cover - Water | Black/Green | 180 | 3 | 20NM |
| 111PBCR | 10" Round Box, Round Overlapping Cover - Reclaimed Water | Purple/Purple | 180 | 3 | 20ND |
| 112BC | 10" Round Box, Round Overlapping Cover - ICV | Green/Green | 180 | 3 | 20ND |
| 112BCB | 10" Round Box, Round Overlapping Bolt-Down Cover - ICV | Green/Green | 180 | 3 | 20ND |
| 112BCRG | 10" Round Box, Round Overlapping Cover - Reclaimed Water | Green/Green | 180 | 3 | 20ND |
| 112BCS | 10" Round Box, Round Overlapping Cover - Sewer | Green/Green | 180 | 3.9 | 20NM |
| 112BCW | 10" Round Box, Round Overlapping Cover - Water | Green/Green | 180 | 3.9 | 20NM |
| Cover Only | | | | | |
| 111C | 10" Round Overlapping Cover - ICV | Green | 300 | 0.95 | 20ND |
| 111C BLK | 10" Round Overlapping Cover - ICV | Black | 300 | 0.95 | 20ND |
| 111C BRN | 10" Round Overlapping Cover - ICV | Brown | 300 | 0.95 | 20ND |
| 111C SAND | 10" Round Overlapping Cover - ICV | Sand | 300 | 0.95 | 20ND |
| 111CR | 10" Round Overlapping Cover - Reclaimed Water | Purple | 300 | 1 | 20ND |
| 111CRG | 10" Round Overlapping Cover - Reclaimed Water | Green | 300 | 0.95 | 20ND |
| 111CS | 10" Round Overlapping Cover - Sewer | Green | 300 | 1 | 20NM |
| 111CW BLK | 10" Round Overlapping Cover - Water | Black | 300 | 0.95 | 20ND |
| 111CW | 10" Round Overlapping Cover - Water | Green | 300 | 1 | 20NM |
| Box Only | | | | | |
| 111B | 10" Round Box | Black | 180 | 2 | 20NM |
| 111BBX2 | 1-3/4" x 5/16" SS Bolt | Steel | n/a | 0.05 | 90WP |
| 111BB | 1-1/4" x 5/16" SS Bolt | Steel | n/a | 0.05 | 20ND |
| 112B | 10" Round Box | Green | 300 | 2 | 20ND |

NDS STANDARD SERIES VALVE BOXES – RESIDENTIAL/COMMERCIAL GRADE

NDS Standard Series 14" x 19" Rectangular Valve Boxes

Specifications: The NDS Standard Series 14" x 19" body is tapered and has a minimum wall thickness of 0.200". The body has a double wall at the top cover seat area with a minimum thickness of 0.250". The cover seat area has 16 structural support ribs on the underside of the seat, each with a minimum thickness of 0.250". The bottom of the body has a 0.500" flange. The 14" x 19" cover has an average thickness of 0.250". The valve box has a 3/8" Brass nut for the bolt-down as a standard feature

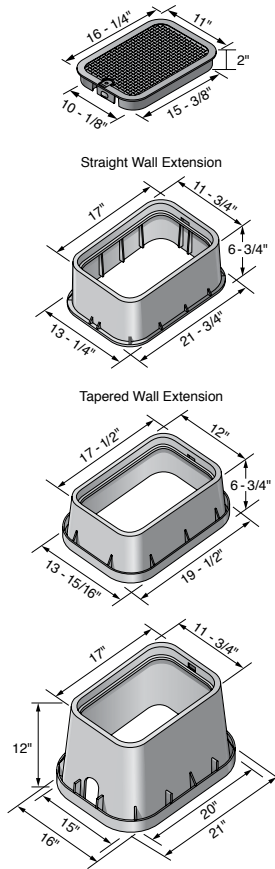

| Part No. | Description | Color (Box/Cover) | Pallet Qty. | Weight Ea. (lbs.) | Product Class |
|------------------------|---|-------------------|-------------|-------------------|---------------|
| Box & Cover | | | | | |
| 115 | 14" x 19" x 6" Extension, Overlapping Cover - ICV | Black/Green | 49 | 16.16 | 20ND |
| 116 | 14" x 19" x 6" Extension, Overlapping Cover - ICV | Green/Green | 49 | 6.16 | 20ND |
| 113BC | 14" x 19" Box, Overlapping Cover - ICV | Black/Green | 78 | 9.1 | 20ND |
| 113BC CTN | 14" x 19" Valve Box Overlap ICV Cover | Black/Green | 48 | 9.32 | 20ND |
| 113BC SAND | 14" x 19" Box, Overlapping Cover - ICV | Sand/Sand | 78 | 9.25 | 20ND |
| 113BCBLK | 14" x 19" Box, Overlapping Cover - ICV | Black/Black | 78 | 9.1 | 20ND |
| 113BCD | 14" x 19" Box, Drop-in Cover - ICV | Black/Green | 78 | 8 | 20ND |
| 113BCE | 14" x 19" Box, Overlapping Cover - Electrical | Black/Green | 78 | 9.32 | 20NM |
| 113BCR | 14" x 19" Box, Overlapping Cover - Reclaimed Water | Black/Purple | 78 | 9.1 | 20ND |
| 113BCRBLK | 14" x 19" Box, Overlapping Cover - Reclaimed Water | Black/Black | 78 | 9.1 | 20ND |
| 113BCRG | 14" x 19" Box, Overlapping Cover - Reclaimed Water | Black/Green | 78 | 9.1 | 20ND |
| 113BCS | 14" x 19" Box, Overlapping Cover - Sewer | Black/Green | 78 | 9.1 | 20ND |
| 113BCW | 14" x 19" Box, Overlapping Bolt-Down Cover - Water | Black/Black | 300 | 9.32 | 20NM |
| 113BCWG | 14" x 19" Box, Overlapping Cover - Water | Black/Green | 78 | 9.1 | 20ND |
| 113PBCR | 14" x 19" Box, Overlapping Cover - Reclaimed Water | Purple/Purple | 78 | 9.29 | 20ND |
| 114BC | 14" x 19" Box, Overlapping Cover - ICV | Green/Green | 78 | 9.95 | 20ND |
| 114BCS | 14" x 19" Box, Overlapping Cover - Sewer | Green/Green | 78 | 9.95 | 20NM |
| 114BCW | 14" x 19" Box, Overlapping Cover - Water | Green/Green | 78 | 9.95 | 20NM |
| 115BCR | 14" x 19" x 6" Box, Overlapping Cover - ICV | Black/Purple | 42 | 7.29 | 20ND |
| 115TBC | 14" x 19" x 6" Tapered Box, Overlapping Cover - ICV | Black/Green | 96 | 6 | 20ND |
| 116TBC | 14" x 19" x 6" Tapered Box, Overlapping Cover - ICV | Green/Green | 96 | 5.55 | 20ND |
| 116TBC SAND | 14" x 19" x 6" Tapered Box, Overlapping Cover - ICV | Sand/Sand | 96 | 6.16 | 20ND |
| Cover Only | | | | | |
| 113C | 14" x 19" Overlapping Cover - ICV | Green | 300 | 2 | 20ND |
| 113C BRN | 14" x 19" Overlapping Cover - ICV | Brown | 300 | 2 | 20ND |
| 113C SAND | 14" x 19" Overlapping Cover - ICV | Sand | 300 | 2 | 20ND |
| 113CB | 14" x 19" Overlapping Cover - ICV | Black | 300 | 2 | 20ND |
| 113CE | 14" x 19" Overlapping Cover - Electrical | Green | 300 | 2.3 | 20NM |
| 113CR | 14" x 19" Overlapping Cover - Reclaimed Water | Purple | 300 | 2.5 | 20ND |
| 113CRB | 14" x 19" Overlapping Cover - Reclaimed Water | Black | 300 | 2 | 20ND |
| 113CRG | 14" x 19" Overlapping Cover - Reclaimed Water | Green | 300 | 2 | 20ND |
| 113CS | 14" x 19" Overlapping Cover - Sewer | Green | 300 | 2 | 20ND |
| 113CW | 14" x 19" Overlapping Cover - Water | Black | 300 | 2 | 20ND |
| 114CW | 14" x 19" Overlapping Cover - Water | Green | 300 | 2 | 20ND |
| Box Only | | | | | |
| 113-6 | 14" x 19" x 6" Extension | Black | 49 | 4.1 | 20ND |
| 113B | 14" x 19" Box | Black | 78 | 6.03 | 20NM |
| 114-6 | 14" x 19" x 6" Rectangular Extension | Green | 49 | 3.86 | 20ND |
| 114B | 14" x 19" Box | Green | 78 | 6.1 | 20ND |
| 116-SAND | 14" x 19" x 6" Extension | Sand | 49 | 6 | 20ND |
| 113BB | 2-1/2" x 3/8" SS Bolt | Steel | n/a | 0.1 | 20NM |

NDS STANDARD SERIES VALVE BOXES – RESIDENTIAL/COMMERCIAL GRADE

NDS Standard Series 13" x 20" Rectangular Valve Boxes

Specifications: The NDS Standard Series 13" x 20" body is tapered and has a minimum wall thickness of 0.250". The body has a double wall at the top cover seat area with a minimum thickness of 0.250". The cover seat area has 16 structural support ribs on the underside of the seat, each with a minimum thickness of 0.250". The bottom of the body has a 0.500" flange. The 13" x 20" cover has an average thickness of 0.250". The valve box has a 3/8" Brass nut for the bolt-down as a standard feature.

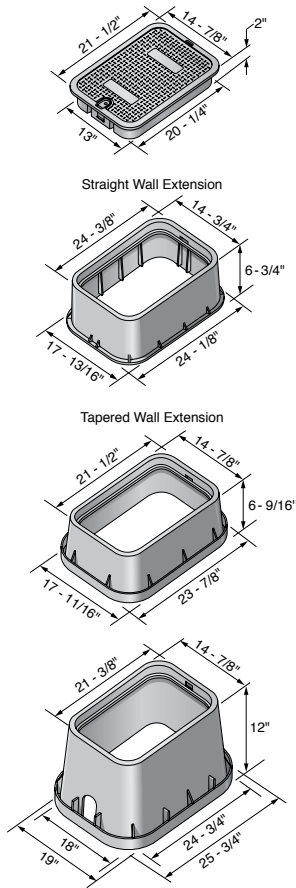

| Part No. | Description | Color (Box/Cover) | Pallet Qty. | Weight Ea. (lbs.) | Product Class |
|------------------------|--|-------------------|-------------|-------------------|---------------|
| Box & Cover | | | | | |
| 119 | 13" x 20" x 6" Jumbo Extension, Overlapping Cover - ICV | Black/Green | 32 | 12 | 20ND |
| 120 | 13" x 20" x 6" Jumbo Extension, Overlapping Cover - ICV | Green/Green | 32 | 12 | 20ND |
| 117BC | 13" x 20" Jumbo Box, Overlapping Cover - ICV | Black/Green | 56 | 14 | 20ND |
| 117BC BLK | 13" x 20" Jumbo Box, Overlapping Cover - ICV | Black/Black | 56 | 14 | 20ND |
| 117BC SAND | 13" x 20" Jumbo Box, Overlapping Cover - ICV | Sand/Sand | 56 | 14 | 20ND |
| 117BCD | 13" x 20" Jumbo Box, Overlapping Cover - ICV | Black/Green | 56 | 14 | 20ND |
| 117BCR | 13" x 20" Jumbo Box, Overlapping Cover - Reclaimed Water | Black/Black | 56 | 14 | 20ND |
| 117BCS | 13" x 20" Jumbo Box, Overlapping Cover - Sewer | Black/Green | 56 | 14 | 20NM |
| 117BCW | 13" x 20" Jumbo Box, Overlapping Cover - Water | Black/Black | 56 | 14 | 20ND |
| 117PBCR | 13" x 20" Jumbo Box, Overlapping Cover - Reclaimed Water | Purple/Purple | 56 | 14 | 20ND |
| 118BC | 13" x 20" Jumbo Box, Overlapping Cover - ICV | Green/Green | 56 | 14 | 20ND |
| 118BCS | 13" x 20" Jumbo Box, Overlapping Cover - Sewer | Green/Green | 56 | 14 | 20ND |
| 118BCW | 13" x 20" Jumbo Box, Overlapping Cover - Water | Green/Green | 56 | 14 | 20ND |
| 118TBC | 13" x 20" x 6" Tapered Box, Overlapping Cover - ICV | Green/Green | 56 | 11.15 | 20ND |
| 119 SAND | 13" x 20" x 6" Jumbo Extension, Overlapping Cover - ICV | Sand/Sand | 32 | 10.95 | 20ND |
| 119TBC | 13" x 20" x 6" Tapered Box, Overlapping Cover - ICV | Black/Green | 56 | 11.15 | 20ND |
| 119TBCR | 13" x 20" Tapered Box, Overlapping Cover - Reclaimed Water | Black/Purple | 56 | 11.15 | 20ND |
| Cover Only | | | | | |
| 117C | 13" x 20" Overlapping Cover - ICV | Green | 180 | 5.3 | 20ND |
| 117C BRN | 13" x 20" Overlapping Cover - ICV | Brown | 180 | 5.3 | 20ND |
| 117C SAND | 13" x 20" Overlapping Cover - ICV | Sand | 180 | 5 | 20ND |
| 117CB | 13" x 20" Overlapping Cover - ICV | Black | 180 | 5.3 | 20ND |
| 117CR | 13" x 20" Overlapping Cover - Reclaimed Water | Purple | 180 | 5.3 | 20ND |
| 117CS | 13" x 20" Jumbo Overlapping Cover - Sewer | Green | 180 | 5 | 20NM |
| 117CW | 13" x 20" Overlapping Cover - Water | Black | 180 | 5.3 | 20ND |
| 118CW | 13" x 20" Overlapping Cover - Water | Green | 180 | 5.3 | 20ND |
| Box Only | | | | | |
| 117-6 | 13" x 20" x 6" Jumbo Extension | Black | 32 | 6.88 | 20ND |
| 117B | 13" x 20" Jumbo Box | Black | 56 | 9.65 | 20NM |
| 118-6 | 13" x 20" x 6" Jumbo Extension | Green | 32 | 6.88 | 20ND |
| 118B | 13" x 20" Jumbo Box | Green | 56 | 9.65 | 20NM |
| 113BB | 2-1/2" x 3/8" SS Bolt | Steel | n/a | 0.1 | 20NM |

NDS STANDARD SERIES VALVE BOXES – RESIDENTIAL GRADE

NDS 6" Round Valve Boxes

Specifications: NDS 6" round body is tapered and has a minimum wall thickness of 0.130". The body has a double wall at the top cover seat area with a minimum thickness of 0.125". The bottom of the body has a 0.250" flange. The 6" round cover has an average thickness of 0.150".

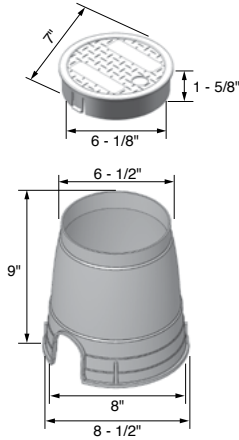

| Part No. | Description | Color (Box/Cover) | Pallet Qty. | Weight Ea. (lbs.) | Product Class |
|------------------------|--|-------------------|---------------------|-------------------|---------------|
| Box & Cover | | | | | |
| D108-G | 6" Valve Box and Overlapping Cover - ICV | Green/Green | 600 | 1.2 | 20ND |
| D109-G | 6" Round Box, 6" Round Cover - ICV | Black/Green | 600 | 1.2 | 20ND |
| D109-P | 6" Round Box, 6" Round Cover - Reclaimed Water | Black/Purple | 600 | 1.21 | 20ND |
| D109-GBOX | 6" Round Box, 6" Round Cover - ICV | Black/Green | 36 Box/ 900 Pal. | 1.2 | 20ND |
| Cover Only | | | | | |
| D109-GL | 6" Round Cover - ICV | Green | 600 | 0.4 | 20ND |
| D109-PL | 6" Round Cover - Reclaimed Water | Purple | 600 | 0.4 | 20ND |
| Box Only | | | | | |
| D109-B/O | 6" Round Box | Black | 600 | 0.8 | 20ME |

NDS 8" x 12" Oval Valve Boxes

Specifications: NDS 8" x 12" body is tapered and has a minimum wall thickness of 0.187". The body has a double wall at the top cover seat area with a minimum thickness of 0.200". The cover seat area has 10 structural support ribs on the underside of the seat, each with a minimum thickness of 0.150". The bottom of the body has a 0.375" flange. The 8" x 12" cover shall have an average thickness of 0.150".

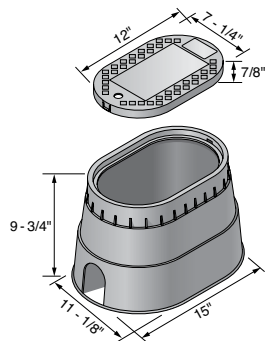

| Part No. | Description | Color (Box/Cover) | Pallet Qty. | Weight Ea. (lbs.) | Product Class |
|------------------------|---|-------------------|-------------|-------------------|---------------|
| Box & Cover | | | | | |
| M2-SG | 8" x 12" Box, Drop-in Cover - Control Valve | Black/Green | 132 | 4 | 20ND |
| Cover Only | | | | | |
| M2-SG-LID | 8" x 12", Drop-in Cover | Green | 132 | 0.719 | 20ND |

NDS STANDARD SERIES VALVE BOXES – RESIDENTIAL GRADE

NDS 8" x 14" Oval Valve Boxes

Specifications: NDS 8" x 14" body is tapered and has a minimum wall thickness of 0.187". The body has a double wall at the top cover seat area with a minimum thickness of 0.200". The cover seat area has 10 structural support ribs on the underside of the seat, each with a minimum thickness of 0.150". The bottom of the body has a 0.375" flange. The 8" x 14" cover has an average thickness of 0.150".

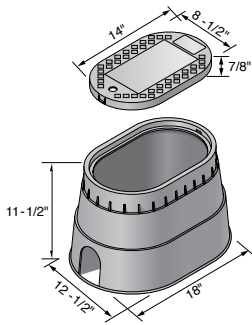

| Part No. | Description | Color (Box/Cover) | Pallet Qty. | Weight Ea. (lbs.) | Product Class |
|-------------|---|-------------------|-------------|-------------------|---------------|
| Box & Cover | | | | | |
| M4-SG | 8" x 14" Box, Drop-in Cover - Control Valve | Black/Green | 96 | 4.6 | 20ND |

NDS 10" x 15" Rectangular Valve Boxes

Specifications: NDS 10" x 15" x 10" body is tapered and has a minimum wall thickness of 0.130". The body has a double wall at the top cover seat area with a minimum thickness of 0.200". The cover seat area has 12 structural support ribs on the underside of the seat, each with a minimum thickness of 0.130". The bottom of the body has a 0.750" flange. The D1000 cover has an average thickness of 0.187". NDS D1000 valve boxes and covers are injection molded of structural foam recycled polyolefin material with a melt index between 10-12. Coloring and UV stabilizers are added, along with processing lubricants when needed.

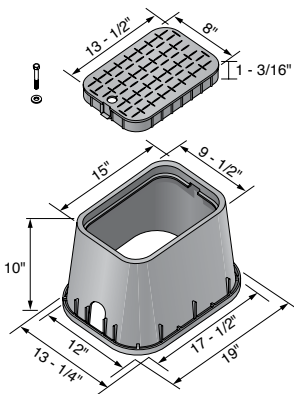

| Part No. | Description | Color (Box/Cover) | Pallet Qty. | Weight Ea. (lbs.) | Product Class |
|-------------|--|-------------------|-------------|-------------------|---------------|
| Box & Cover | | | | | |
| D1000-SG | 10" x 15" x 10" Box, Drop-in Cover - Valve Box | Black/Green | 96 | 4.8 | 20ND |
| Cover Only | | | | | |
| D1000-SGL | 10" x 15" Drop-in Cover - Valve Box | Green | 360 | 1.4 | 20ND |
| Box Only | | | | | |
| D1000-B/O | 10" x 15" x 10" Box | Black | 96 | 3.4 | 20ME |

VALVE BOXES PRODUCTS INDEX

| Part No. | Page | Part No. | Page | Part No. | Page | Part No. | Page | Part No. | Page |
|------------|------|-------------|-------------------------|-------------|------|-------------|------|--------------|------|
| 106B | 199 | 112BCRG | 200 | 117C SAND | 202 | 313BCBRG | 195 | 321B | 197 |
| 107B | 199 | 112BCS | 200 | 117CW | 202 | 313BCBS | 195 | 321BCB | 197 |
| 107BC | 199 | 112BCW | 200 | 117PBCR | 202 | 313BCBW | 195 | 321BCB-BG | 197 |
| 107BC ARNB | 199 | 113-6 | 201 | 118-6 | 202 | 313BCBWBLK | 195 | 321BCBS | 197 |
| 107BC BLK | 199 | 113B | 201 | 118B | 202 | 313C | 195 | 321BCBW | 197 |
| 107BC CTN | 199 | 113BB | 194, 195, 196, 201, 202 | 118BC | 202 | 313CBLK | 195 | 322B | 197 |
| 107BCB | 199 | 113BC | 201 | 118BCS | 202 | 313CBRN | 195 | 322BCB | 197 |
| 107BCR | 199 | 113BCBLK | 201 | 118BCW | 202 | 313C ELEC | 195 | 322C | 197 |
| 107BCR BLK | 199 | 113BC CTN | 201 | 118CW | 202 | 313CG ELEC | 195 | 322CS | 197 |
| 107BCS | 199 | 113BCD | 201 | 118TBC | 202 | 313CR | 195 | 322PBCBR | 197 |
| 107BC SAND | 199 | 113BCE | 201 | 119 | 202 | 313CRBLK | 195 | 323C | 198 |
| 107BC SLV | 199 | 113BCR | 201 | 119 SAND | 202 | 313CRG | 195 | 323CD | 198 |
| 107BCW | 199 | 113BCRBLK | 201 | 119TBC | 202 | 313CSAND | 195 | 323CD ELEC | 198 |
| 107C | 199 | 113BCRG | 201 | 119TBCR | 202 | 313CW | 195 | 323CDW | 198 |
| 107C BLK | 199 | 113BCS | 201 | 120 | 202 | 314B | 195 | 323CR | 198 |
| 107C BRN | 199 | 113BC SAND | 201 | 121BB | 197 | 314BBLK | 195 | 323CS | 198 |
| 107CH | 199 | 113BCW | 201 | 311B | 194 | 314BC | 195 | 324B | 198 |
| 107CR | 199 | 113BCWG | 201 | 311BC | 194 | 314BC ARNB | 195 | 324B BLK | 198 |
| 107CS | 199 | 113C | 201 | 311BCB | 194 | 314BCB | 195 | 324BCB | 198 |
| 107C SAND | 199 | 113CB | 201 | 311BCBLK | 194 | 314BCB ELEC | 195 | 324BCB-BG | 198 |
| 107CW | 199 | 113C BRN | 201 | 311BCBW | 194 | 314BCBRG | 195 | 324BCBS | 198 |
| 107EBC | 199 | 113CE | 201 | 311BCR | 194 | 314BCBS | 195 | 324BCDB | 198 |
| 107EBCR | 199 | 113CR | 201 | 311BCS | 194 | 314BCBSAND | 195 | 325B | 197 |
| 107PBCR | 199 | 113CRB | 201 | 311BCW | 194 | 314BCBW | 195 | 325BCB | 197 |
| 108B | 199 | 113C SAND | 201 | 311C | 194 | 314BCSAND | 195 | 326B | 198 |
| 108BC | 199 | 113PBCR | 201 | 311C BLK | 194 | 314CS | 195 | 326B BLK | 198 |
| 108BCS | 199 | 114-6 | 201 | 311C BRN | 194 | 314CW | 195 | 326BCB | 198 |
| 108BCW | 199 | 114B | 201 | 311C ELEC | 194 | 314PBCBR | 195 | 326BCB-BG | 198 |
| 111B | 200 | 114BC | 201 | 311CR | 194 | 314PBCR | 195 | 326BCDB | 198 |
| 111BB | 200 | 114BCS | 201 | 311CRG | 194 | 317BCB | 196 | 326BCDB-BG | 198 |
| 111BBX2 | 200 | 114BCW | 201 | 311CS | 194 | 317BCBBLK | 196 | 326BCDB ELEC | 198 |
| 111BC | 200 | 114CW | 201 | 311CSAND | 194 | 317BCBS | 196 | 326BCDBW | 198 |
| 111BCB | 200 | 115 | 201 | 311CW | 194 | 317BCBW | 196 | 326PBCBR | 198 |
| 111BC BLK | 200 | 115BCR | 201 | 311CW BLK | 194 | 317C | 196 | D108-G | 203 |
| 111BCBW | 200 | 115TBC | 201 | 312B | 194 | 317C BLK | 196 | D109-B/O | 203 |
| 111BC CTN | 200 | 116 | 201 | 312BC | 194 | 317C BRN | 196 | D109-G | 203 |
| 111BCR | 200 | 116-SAND | 201 | 312BCB | 194 | 317CR | 196 | D109-GBOX | 203 |
| 111BCR BLK | 200 | 116TBC | 201 | 312BCB ELEC | 194 | 317CS | 196 | D109-GL | 203 |
| 111BCS | 200 | 116TBC SAND | 201 | 312BCBS | 194 | 317CSAND | 196 | D109-P | 203 |
| 111BC SAND | 200 | 117-6 | 202 | 312BC ELEC | 194 | 317CW | 196 | D109-PL | 203 |
| 111BCW | 200 | 117B | 202 | 312BCRBLK | 194 | 318B | 196 | D1000-B/O | 204 |
| 111C | 200 | 117BC | 202 | 312BCRG | 194 | 318B BLK | 196 | D1000-SG | 204 |
| 111C BRN | 200 | 117BC BLK | 202 | 312BCS | 194 | 318BC | 196 | D1000-SGL | 204 |
| 111CR | 200 | 117BCD | 202 | 312BCSAND | 194 | 318BCB | 196 | M2-SG | 203 |
| 111CRG | 200 | 117BCR | 202 | 312BCW | 194 | 318BCBRBLK | 196 | M2-SG-LID | 203 |
| 111CS | 200 | 117BCS | 202 | 312PB | 194 | 318BCBRG | 196 | M4-SG | 204 |
| 111C SAND | 200 | 117BC SAND | 202 | 312PBCBR | 194 | 318BCBS | 196 | | |
| 111CW | 200 | 117BCW | 202 | 312PBCR | 194 | 318BCBSAND | 196 | | |
| 111CW BLK | 200 | 117C | 202 | 313BC | 195 | 318BCBW | 196 | | |
| 111PBCR | 200 | 117CB | 202 | 313BCB | 195 | 318CW | 196 | | |
| 112B | 200 | 117C BRN | 202 | 313BCBBLK | 195 | 318PB | 196 | | |
| 112BC | 200 | 117CR | 202 | 313BCBR | 195 | 318PBCBR | 196 | | |
| 112BCB | 200 | 117CS | 202 | 313BCBRBLK | 195 | 318PBCR | 196 | | |

NDS AUTOMATIC METER READER (AMR) BOXES – STANDARD COMMERCIAL GRADE



Superior signal transmission versus products made of concrete materials or cast iron.

Lighter weight material eases installation and lowers freight and handling costs.

Designed specifically for the Automatic Meter reading industry, the newest line of AMR boxes builds on the NDS tradition of strength, durability and value. Like our current automatic Meter Reading products, this new line of AMR boxes and covers are injection-molded of polyoefins and contain UV inhibitors to prevent discoloration and cracking.

Bottom Mounts

- Concealed antennae are completely protected from landscape equipment damage and are less likely to draw attention from vandals
- Exceptional antennae signal transmissions
- Offset cavities eliminate the physical interference between antennae and meter
- Bracket accommodates a majority of the industry antennae

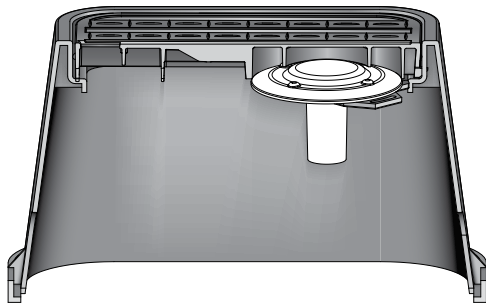

Single AMR bottom mount
(pre-assembled bracket)

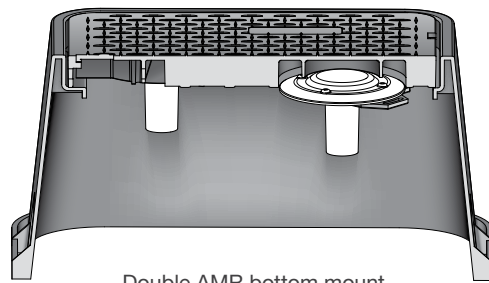

Double AMR bottom mount
(pre-assembled bracket)

Top Mounts

- Recess reduces the probability of damage caused by landscape equipment and vandals
- Offset recesses eliminate the physical interference between the antennae and meter
- Recess and holes accommodate most of the industry antennae
- Compatible with many of the industry Touch Read antennae

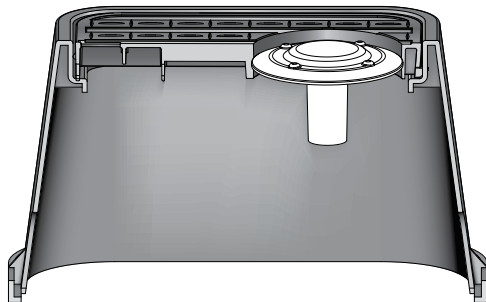

Single AMR top mount

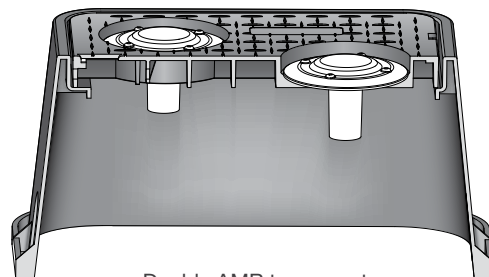

Double AMR top mount

NDS AUTOMATIC METER READER (AMR) BOXES – STANDARD COMMERCIAL GRADE

NDS 14" x 19" AMR Meter Boxes & Covers

Specifications: NDS 14" x 19" AMR meter boxes and covers are injection molded of structural foam recycled polyolefin material with a melt index between 10-12. Coloring and UV stabilizers are added, along with processing lubricants when needed. NDS 14" x 19" x 12" body is tapered and has a minimum wall thickness of 0.250". The body has a double wall at the top cover seat area with a minimum thickness of 0.187". The cover seat area has 30 structural support ribs on the underside of the seat, each with a minimum thickness of 3/16". The bottom of the body has a 1" flange. The 14" x 19" cover has a minimum thickness of 0.250".

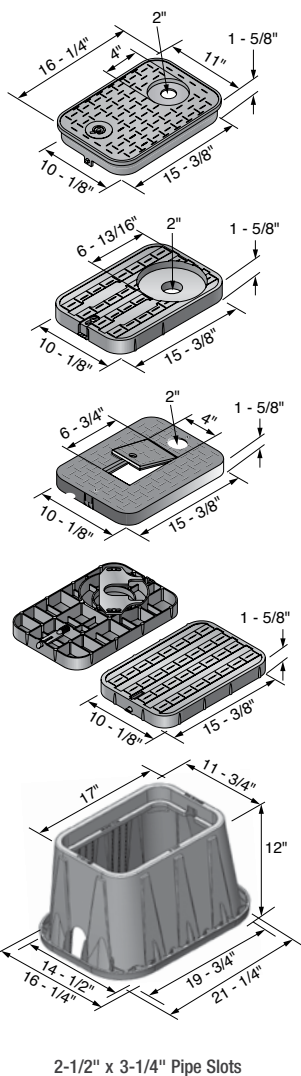

| Part No. | Description - Marking | Color (Box/Cover) | Pallet Qty. | Wt. Ea. lbs. | Product Class |
|------------------------------------|--|-------------------|-------------|--------------|---------------|
| Drop-in Box & Cover | | | | | |
| D12-BAMR | 14" x 19" x 12" Box, Drop-in Locking Solid Plastic, Single Bottom Mount AMR Bracket Cover - Water Meter | Black/Black | 72 | 8.90 | 20ME |
| D12-TAMR | 14" x 19" x 12" Box, Drop-in Locking Solid Plastic, Single 2" AMR/TR Hole w/ 7" Top Recess Cover - Water Meter | Black/Black | 72 | 9.22 | 20ME |
| D1200-DITR | 14" x 19" x 12" Box, Drop-in Solid Plastic, Single 2" AMR/TR Hole Cover - Water Meter | Black/Black | 72 | 9.00 | 20ME |
| Overlapping Box & Cover | | | | | |
| D12AMR-OLLOCTRBLUL | 14" x 19" Blue Overlapping Solid Plastic, Single 1.75" AMR/TR Hole w/ 4" Top Recess Cover - Water Meter | Blue | 100 | 2.80 | 20ME |
| D1200-OLTR | 14" x 19" x 12" Box, Overlapping Solid Plastic, Single 2" AMR/TR Hole Cover - Water Meter | Black/Black | 72 | 9.20 | 20ME |
| Drop-in Cover Only | | | | | |
| D12-BAMRL | 14" x 19" Drop-in Locking Solid Plastic, Single Bottom Mount AMR Bracket Cover - Water Meter | Black | 100 | 2.10 | 20ME |
| D12-TAMRL | 14" x 19" Drop-in Locking Solid Plastic, Single 2" AMR/TR Hole w/ 7" Top Recess Cover - Water Meter | Black | 100 | 2.42 | 20ME |
| D1200-DITRL | 14" x 19" Drop-in Solid Plastic, Single 2" AMR/TR Hole Cover - Water Meter | Black | 100 | 2.20 | 20ME |
| D12-TAMRBLUL | 12" x 17" AMR Top Mount Locking Lid | Blue | 100 | 2.42 | 20ME |
| Overlapping Cover Only | | | | | |
| D12AMR-OLLOCL | 14" x 19" Overlapping Solid Plastic, Single 4" Top Recess Cover - Water Meter | Black | 100 | 2.80 | 20ME |
| D12AMR-OLLOCTRL | 14" x 19" Overlapping Solid Plastic, Single 1.75" AMR/TR Hole w/ 4" Top Recess Cover - Water Meter | Black | 100 | 2.80 | 20ME |
| Box Only | | | | | |
| D1200-B/O | 14" x 19" x 12" Box | Black | 72 | 6.80 | 20ME |
| D600E-EXT | 14" x 19" x 6" Extension | Black | 42 | 4.20 | 20ME |
| D1800-B/O | 14" x 19" x 18" Box | Black | 48 | 10.00 | 20ME |
| Box with Overlapping Cover | | | | | |
| D600E-DISG | 12" x 6" Extension Drop-in Solid Plastic Cover | Black/Green | 42 | 6.40 | 20ME |

NDS AUTOMATIC METER READER (AMR) BOXES – STANDARD COMMERCIAL GRADE

NDS 13" x 20" AMR Boxes & Covers

Specifications: NDS 13" x 20" AMR meter boxes and covers are injection molded of structural foam recycled polyolefin material with a melt index between 10-12. Coloring and UV stabilizers are added, along with processing lubricants when needed. The 13" x 20" body is tapered and has a minimum wall thickness of 0.250". The body has a double wall at the top cover seat area with a minimum thickness of 0.187". The cover seat area has 30 structural support ribs on the underside of the seat, each with a minimum thickness of 3/16". The bottom of the body has a 1" flange. The 14" x 19" cover has an average thickness of 0.250".

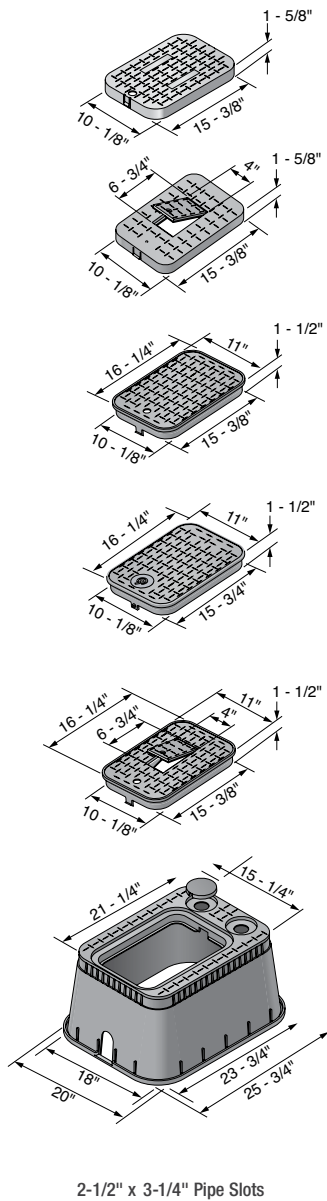

| Part No. | Description - Marking | Color (Box/Cover) | Pallet Qty. | Wt. Ea. lbs. | Product Class |
|------------------------------------|---|-------------------|-------------|--------------|---------------|
| Drop-in Box & Cover | | | | | |
| D15AMR2-DI | 13" x 20" x 12" Jumbo AMR Box, Drop-in Solid Plastic Cover - Water Meter | Black/Black | 48 | 16.20 | 20ME |
| D1200-DICIRBLU | 12" x 17" Box with Drop-in Plastic Cover with cast Iron Meter Reader | Black/Blue | 72 | 10.20 | 20ME |
| Overlapping Box & Cover | | | | | |
| D15AMR2-OLLOC | 13" x 20" x 12" Jumbo AMR Box, Overlapping Locking Solid Plastic Cover - Water Meter | Black/Black | 48 | 16.60 | 20ME |
| D15AMR2-OLR | 13" x 20" x 12" Jumbo AMR Box, Overlapping Meter Reader Plastic w/ Plastic Reader Cover - Water Meter | Black/Black | 48 | 16.40 | 20ME |
| Drop-in Cover Only | | | | | |
| D1200-DISBL | 14" x 19" Drop-in Solid Plastic Cover - Water Meter | Black | 216 | 2.20 | 20ME |
| D1200-DIRBL | 14" x 19" Drop-in Meter Reader Plastic w/ Plastic Reader Cover - Water Meter | Black | 216 | 2.20 | 20ME |
| D1200-DICIRLID | 14" x 19" Drop-in Meter Reader Plastic w/ Cast Iron Reader Cover - Water Meter | Black | 216 | 3.40 | 20ME |
| Overlapping Cover Only | | | | | |
| D1200-OLSBL | 14" x 19" Overlapping Solid Plastic Cover - Water Meter | Black | 216 | 2.40 | 20ME |
| D1200-OLLOCBLD | 14" x 19" Overlapping Locking Solid Plastic Cover - Water Meter | Black | 100 | 2.60 | 20ME |
| Box Only | | | | | |
| D15AMR2-B/O | 13" x 20" x 12" Jumbo AMR Box with No Pipe Slots | Black | 48 | 12.09 | 20ME |
| D15AMR2-DU B/O | 13" x 20" x 12" Jumbo AMR Box with Dual Pipe Slots Reader End | Black | 48 | 10.20 | 20ME |
| D15AMR2-PS B/O | Jumbo AMR Box with Pipe Slots | Black | 48 | 10.20 | 20ME |

NDS AUTOMATIC METER READER (AMR) BOXES – STANDARD COMMERCIAL GRADE

NDS 13" x 20" Jumbo Boxes & AMR Covers

Specifications: NDS 13" x 20" meter boxes and AMR covers are injection molded of structural foam recycled polyolefin material with a melt index between 10-12. Coloring and UV stabilizers are added, along with processing lubricants when needed. The 13" x 20" body is tapered and has a minimum wall thickness of 0.250". The body has a double wall at the top cover seat area with a minimum thickness of 0.187". The cover seat has 56 structural support ribs on the underside of the seat, each with a minimum thickness of 1/50". The bottom of the body has a 1" flange. The 13" x 20" cover has an average thickness of 0.25".

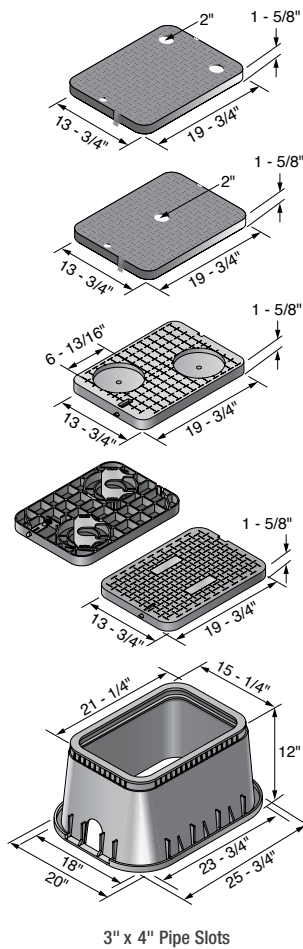

| Part No. | Description - Marking | Color (Box/Cover) | Pallet Qty. | Wt. Ea. lbs. | Product Class |
|---------------------|---|-------------------|-------------|--------------|---------------|
| Drop-in Box & Cover | | | | | |
| D15-BAMR | 13" x 20" x 12" Jumbo Box, Drop-in Locking Solid Plastic w/Double Bottom Mount AMR Brackets Cover - Water Meter | Black/Black | 48 | 24.40 | 20ME |
| D15DU-BAMR | 13" x 20" x 12" Dual Pipe Slot Box, Drop-in Locking Solid Plastic w/ Double Bottom Mount AMR Brackets Cover - Water Meter | Black/Black | 48 | 23.91 | 20ME |
| D1500-DISBTR | 13" x 20" x 12" Jumbo Box, Drop-in Solid Plastic w/ Single Custom AMR/TR Hole Cover - Water Meter | Black/Black | 48 | 13.20 | 20ME |
| Drop-in Cover Only | | | | | |
| D15-BAMRL | 13" x 20" Drop-in Locking Solid Plastic w/ Double Bottom Mount AMR Brackets Cover - Water Meter | Black | 96 | 15.00 | 20ME |
| D15-BAMRLP-AM | 13" x 20" x 12" Drop in Solid Plastic Cover - Reclaimed Water | Purple | 96 | 15.00 | 20ME |
| D15-BAMRP | 13" x 20" x 12" Drop in Solid Plastic Cover with Lid - Reclaimed Water | Purple/Purple | 48 | 15.00 | 20ME |
| Box Only | | | | | |
| D1500-B/O | 13" x 20" x 12" Jumbo Box | Black | 48 | 9.40 | 20ME |
| D1500-DUB/O | 13" x 20" x 12" Dual Pipe Slot Box | Black | 48 | 8.91 | 20ME |
| D750E-EXT | 13" x 20" x 6" Extension | Black | 36 | 5.60 | 20ME |

NDS METER BOXES – STANDARD COMMERCIAL GRADE

NDS D109 Meter Boxes

Specifications: NDS 6" round meter boxes and covers are injection molded of recycled polyolefin material with a melt index between 10-12. Coloring and UV stabilizers are added, along with processing lubricants when needed. The 6" round body is tapered and has a minimum wall thickness of 0.13". The body has a double wall at the top cover seat area with a minimum thickness of 0.125". The bottom of the body has a 0.250" flange. The 6" round cover has an average thickness of 0.15".

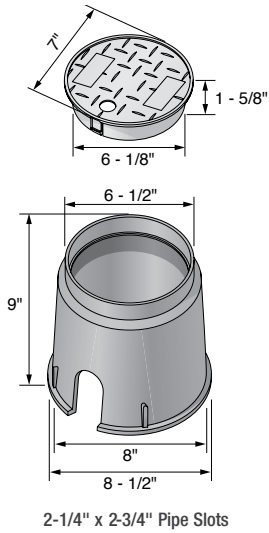

| Part No. | Description - Marking | Color (Box/Cover) | Pallet Qty. | Wt. Ea. lbs. | Product Class |
|------------------------|---|-------------------|-------------|--------------|---------------|
| Box & Cover | | | | | |
| D109-B | 6" Round Box, Overlapping Solid Plastic Cover - Water Meter | Black/Black | 900 | 1.21 | 20ME |
| D109-P | 6" Round Box, Overlapping Solid Plastic Cover - Reclaimed Water | Purple/Purple | 900 | 1.21 | 20ME |
| Cover Only | | | | | |
| D109-PL | 6" Round Overlapping Solid Plastic Cover - Reclaimed Water | Purple | 900 | 0.40 | 20ME |
| D1100-SPL | 10" Overlapping Cover - Reclaimed | Purple | 350 | 0.80 | 20ME |
| Box Only | | | | | |
| D109-B/O | 6" Round Box | Black | 600 | 0.80 | 20ME |

NDS D1000 Meter Boxes

Specifications: NDS D1000 meter boxes and covers are injection molded of structural foam recycled polyolefin material with a melt index between 10-12. Coloring and UV stabilizers are added, along with processing lubricants when needed. NDS 10" x 15" x 10" body is tapered and has a minimum wall thickness of 0.13". The body has a double wall at the top cover seat area with a minimum thickness of 0.20". The cover seat area has 12 structural support ribs on the underside of the seat, each with a minimum thickness of 0.13". The bottom of the body has a 0.75" flange.

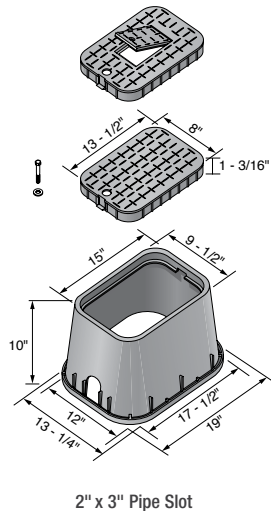

| Part No. | Description - Marking | Color (Box/Cover) | Pallet Qty. | Wt. Ea. lbs. | Product Class |
|--------------------------------|---|-------------------|-------------|--------------|---------------|
| Drop-in Box & Cover | | | | | |
| D1000-SB | 10" x 15" x 10" Box, Drop-in Solid Plastic Cover - Water Meter | Black/Black | 96 | 5 | 20ME |
| D1000-RB | 10" x 15" x 10" Box, Drop-in Meter Reader Plastic w/ Plastic Reader Cover - Water Meter | Black/Black | 96 | 5 | 20ME |
| Drop-in Cover Only | | | | | |
| D1000-SBL | 10" x 15" Drop-in Meter Solid Plastic Cover - Water Meter | Black | 300 | 1.4 | 20ME |
| D1000-RBL | 10" x 15" Drop-in Meter Reader w/ Plastic Reader Cover - Water Meter | Black | 300 | 1.6 | 20ME |

NDS METER BOXES – STANDARD COMMERCIAL GRADE

NDS D1200 Meter Boxes

Specifications: NDS D1200 meter boxes and covers are injection molded of structural foam recycled polyolefin material with a melt index between 10-12. Coloring and UV stabilizers are added, along with processing lubricants when needed. NDS 14" x 19" x 12" body is tapered and has a minimum wall thickness of 0.25". The body has a double wall at the top cover seat area with a minimum thickness of 0.187". The cover seat area has 30 structural support ribs on the underside of the seat, each with a minimum thickness of 3/16". The bottom of the body has a 1" flange. The D1200 cover has a minimum thickness of 0.250".

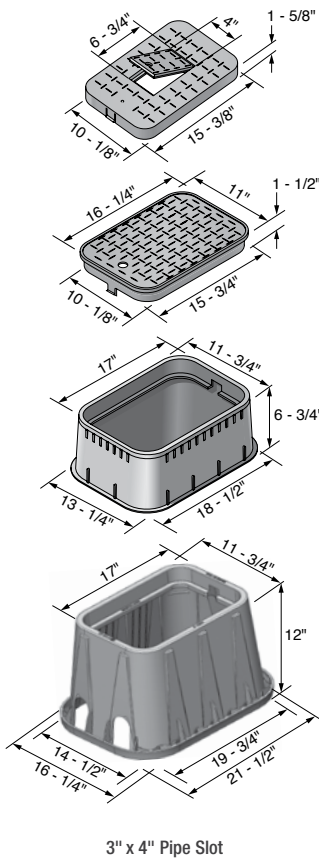

| Part No. | Description - Marking | Color (Box/Cover) | Pallet Qty. | Wt. Ea. lbs. | Product Class |
|--------------------------------|---|-------------------|-------------|--------------|---------------|
| Drop-in Box & Cover | | | | | |
| D1200-DISB | 14" x 19" x 12" Standard Box, Drop-in Solid Plastic Cover - Water Meter | Black/Black | 72 | 9.00 | 20ME |
| D1200-DUDISB | 14" x 19" x 12" Standard Dual Pipe Slot Box, Drop-in Solid Plastic Cover - Water Meter | Black/Black | 72 | 9.00 | 20ME |
| D1200-DISBSWR | 14" x 19" x 12" Standard Box, Drop-in Solid Plastic Cover - Sewer | Black/Black | 72 | 9.00 | 20ME |
| D1200-DISGSWR | 14" x 19" x 12" Standard Box, Drop-in Solid Plastic Cover - Sewer | Black/Green | 72 | 9.00 | 20ME |
| D1200G-DISGSWR | 14" x 19" x 12" Standard Box, Drop-in Solid Plastic Cover - Sewer | Green/Green | 72 | 9.00 | 20ME |
| D1200-DISBLU | 14" x 19" x 12" Standard Box, Drop-in Solid Plastic Cover - Water Meter | Black/Blue | 72 | 9.00 | 20ME |
| D1200-DIRB | 14" x 19" x 12" Standard Box, Drop-in Meter Reader Plastic w/ Plastic Reader Cover - Water Meter | Black/Black | 72 | 9.00 | 20ME |
| D1200-DUDIRB | 14" x 19" x 12" Standard Dual Pipe Slot Box, Drop-in Meter Reader Plastic w/ Plastic Reader Cover - Water Meter | Black/Black | 72 | 9.00 | 20ME |
| D1200-DIBLRD | 14" x 19" x 12" Standard Box, Drop-in Meter Reader Plastic w/ Plastic Reader Cover - Water Meter | Black/Blue | 72 | 9.00 | 20ME |
| D1200-DIRG | 14" x 19" x 12" Standard Box, Drop-in Meter Reader Plastic w/ Plastic Reader Cover - Water Meter | Black/Green | 72 | 9.00 | 20ME |
| D1200-DICIR | 14" x 19" x 12" Standard Box, Drop-in Meter Reader Plastic w/ Cast Iron Reader Cover - Water Meter | Black/Black | 72 | 10.20 | 20ME |
| D1200-DUDICIR | 14" x 19" x 12" Standard Dual Pipe Slot Box, Drop-in Meter Reader Plastic w/ Cast Iron Reader Cover - Water Meter | Black/Black | 72 | 10.20 | 20ME |
| D1200P-DICIRP | 14" x 19" x 12" Standard Box, Drop-in Meter Reader Plastic w/ Cast Iron Reader Cover - Reclaimed Water | Purple/Purple | 72 | 10.20 | 20ME |
| Cover Only | | | | | |
| D1200-DISBLUL | 12" Drop in Solid Plastic Cover - Meter Reader | Blue | 216 | 2.20 | 20ME |

NDS METER BOXES – STANDARD COMMERCIAL GRADE

NDS D1200 Meter Boxes (continued)

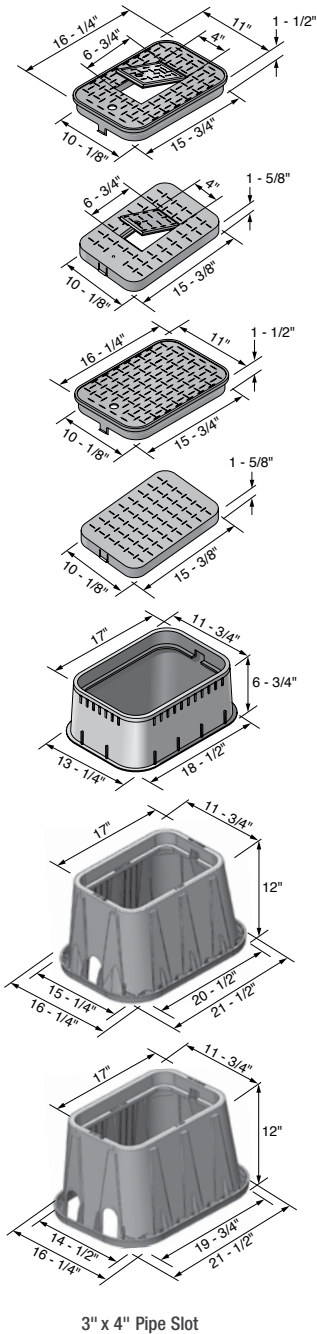

| Part No. | Description - Marking | Color (Box/Cover) | Pallet Qty. | Wt. Ea. lbs. | Product Class |
|------------------------------------|--|-------------------|-------------|--------------|---------------|
| Overlapping Box & Cover | | | | | |
| D1200-OLSB | 14" x 19" x 12" Standard Box, Overlapping Solid Plastic Cover – Water Meter | Black/Black | 72 | 9.20 | 20ME |
| D1200-DUOLSB | 14" x 19" x 12" Standard Dual Pipe Slot Box, Overlapping Solid Plastic Cover – Water Meter | Black/Black | 72 | 9.20 | 20ME |
| D1200-OLLOCB | 14" x 19" x 12" Standard Box, Overlapping Locking Solid Plastic Cover – Water Meter | Black/Black | 72 | 9.40 | 20ME |
| D1200-CI | 14" x 19" x 12" Standard Box, Overlapping Solid Cast Iron Cover – Water Meter | Black/Black | 72 | 19.00 | 20ME |
| D1200-OLRB | 14" x 19" x 12" Standard Box, Overlapping Meter Reader Plastic with Plastic Reader Cover – Water Meter | Black/Black | 72 | 9.20 | 20ME |
| D1200-OLCIR | 14" x 19" x 12" Standard Box, Overlapping Meter Reader Plastic with Cast Iron Reader Cover – Water Meter | Black/Black | 72 | 10.60 | 20ME |
| D1200-OLRBLU | 12" Overlapping Cover with Plastic Meter Reader | Black/Blue | 72 | 9.20 | 20ME |
| D1200-CICIR | 14" x 19" x 12" Standard Box, Overlapping Meter Reader Cast Iron w/ Cast Iron Reader Cover – Water Meter | Black/Black | 72 | 10.28 | 20ME |
| Drop-in Cover Only | | | | | |
| D1200-DISBL | 14" x 19" Drop-in Solid Plastic Cover – Water Meter | Black | 216 | 2.20 | 20ME |
| D1200-DISBSWRL | 14" x 19" Drop-in Solid Plastic Cover – Sewer | Black | 216 | 2.20 | 20ME |
| D1200-DISGL | 12" Drop in Solid Plastic Cover – Meter Reader | Green | 216 | 2.20 | 20ME |
| D1200-DISGSWRL | 14" x 19" Drop-in Solid Plastic Cover – Sewer | Green | 216 | 2.20 | 20ME |
| D1200-DIRBL | 14" x 19" Drop-in Meter Reader with Plastic Reader Cover – Water Meter | Black | 216 | 2.20 | 20ME |
| D1200-DIBLRDL | 14" x 19" Drop-in Meter Reader with Plastic Reader Cover – Water Meter | Blue | 216 | 2.20 | 20ME |
| D1200-DICIRLID | 14" x 19" Drop-in Meter Reader with Cast Iron Reader Cover – Water Meter | Black | 216 | 3.40 | 20ME |
| Overlapping Cover Only | | | | | |
| D1200-CICIR LD | 14" x 19" Overlapping Cast Iron Lid with Cast Iron Reader – Water Meter | Black | 216 | 2.40 | 20ME |
| D1200-OLSBL | 14" x 19" Overlapping Solid Plastic Cover – Water Meter | Black | 216 | 2.40 | 20ME |
| D1200-OLSGL | 12" Overlapping Cover with Solid Plastic Meter Reader | Green | 216 | 2.40 | 20ME |
| D1200-OLLOCBLD | 14" x 19" Overlapping Locking Solid Plastic Cover – Water Meter | Black | 100 | 2.60 | 20ME |
| D1200-OLBLL | 14" x 19" Overlapping Solid Plastic Cover – Water Meter | Blue | 216 | 2.40 | 20ME |
| D1200-CIL | 14" x 19" Overlapping Meter Reader Solid Cast Iron Cover – Water Meter | Black | 216 | 12.20 | 20ME |
| D1200-OLRBLUL | 14" x 19" Overlapping Meter Reader Plastic with Plastic Reader Cover – Water Meter | Blue | 216 | 2.40 | 20ME |
| D1200-OLCIR LD | 14" x 19" Overlapping Meter Reader Plastic with Cast Iron Reader Cover – Water Meter | Black | 216 | 3.80 | 20ME |
| D1200-OLCIRSS | 12" Overlapping Cover with Cast Iron Meter Reader | Black/Black | 72 | 10.33 | 20ME |
| Box Only | | | | | |
| D1200-B/O | 14" x 19" x 12" Standard Box | Black | 72 | 6.80 | 20ME |
| D1200-DUB/O | 14" x 19" x 12" Standard Dual Pipe Slot Box | Black | 72 | 6.80 | 20ME |
| D1200G-B/O | 14" x 19" x 12" Standard Box | Green | 72 | 6.80 | 20ME |
| D600E-EXT | 14" x 19" x 6" Extension Only | Black | 42 | 4.20 | 20ME |

NDS METER BOXES – STANDARD COMMERCIAL GRADE

NDS D1500 Meter Boxes

Specifications: NDS 13" x 20" meter boxes and covers are injection molded of structural foam recycled polyolefin material with a melt index between 10-12. Coloring and UV stabilizers are added, along with processing lubricants when needed. The 13" x 20" body is tapered and has a minimum wall thickness of 0.250". The body has a double wall at the top cover seat area with a minimum thickness of 0.187". The cover seat area has 30 structural support ribs on the underside of the seat, each with a minimum thickness of 1/50". The bottom of the body has a 1" flange. The 13" x 20" cover has an average thickness of 0.250".

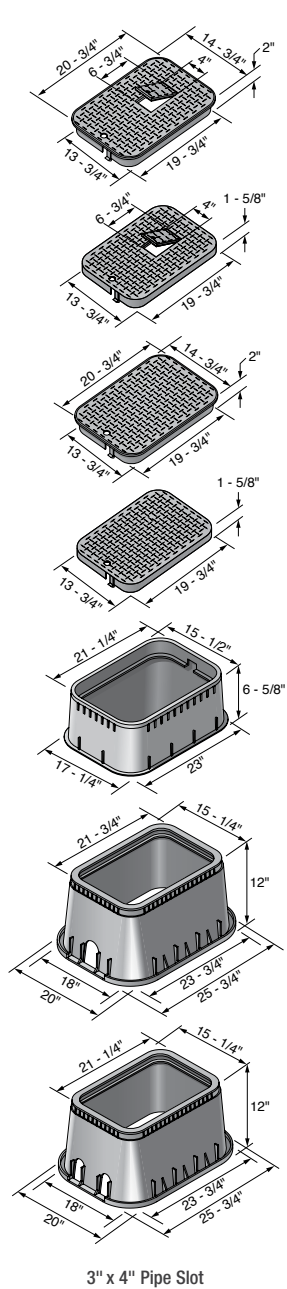

| Part No. | Description - Marking | Color (Box/Cover) | Pallet Qty. | Wt. Ea. lbs. | Product Class |
|------------------------------------|--|-------------------|-------------|--------------|---------------|
| Drop-in Box & Cover | | | | | |
| D1500-DISB | 13" x 20" x 12" Jumbo Box, Drop-in Solid Plastic Cover – Water Meter | Black/Black | 48 | 13.20 | 20ME |
| D1500-DUDISB | 13" x 20" x 12" Dual Pipe Slot Jumbo Box, Drop-in Solid Plastic Cover – Water Meter | Black/Black | 48 | 13.49 | 20ME |
| D1500-DIRB | 13" x 20" x 12" Jumbo Box, Drop-in Meter Reader Plastic w/ Plastic Reader Cover – Water Meter | Black/Black | 48 | 13.20 | 20ME |
| D1500-DUDIRB | 13" x 20" x 12" Dual Pipe Slot Jumbo Box, Drop-in Meter Reader Plastic with Plastic Reader Cover – Water Meter | Black/Black | 48 | 13.49 | 20ME |
| D1500-DICIR | 13" x 20" x 12" Jumbo Box, Drop-in Meter Reader Plastic w/ Cast Iron Reader Cover – Water Meter | Black/Black | 48 | 14.40 | 20ME |
| D1500-DUDICIR | 13" x 20" x 12" Dual Pipe Slot Jumbo Box, Drop-in Meter Reader Plastic with Cast Iron Reader Cover – Water Meter | Black/Black | 48 | 13.20 | 20ME |
| D1500P-DU-DICP | 13" x 20" x 12" Dual Pipe Slot Jumbo Box, Drop-in Meter Reader Plastic with Cast Iron Reader Cover – Water Meter | Purple/Purple | 48 | 14.60 | 20ME |
| D1500-DIRBLU | 13" x 20" Drop-in Plastic Cover with Plastic Meter Reader – Water Meter | Blue/Blue | 48 | 11.60 | 20ME |
| Overlapping Box & Cover | | | | | |
| D1500-OLSB | 13" x 20" x 12" Jumbo Box, Overlapping Solid Plastic Cover – Water Meter | Black/Black | 48 | 13.20 | 20ME |
| D1500-OLRB | 13" x 20" x 12" Jumbo Box, Overlapping Meter Reader Plastic w/ Plastic Reader Cover – Water Meter | Black/Black | 48 | 13.20 | 20ME |
| Drop-in Cover Only | | | | | |
| D1500-DISBL | 13" x 20" Drop-in Solid Plastic Cover – Water Meter | Black | 96 | 3.80 | 20ME |
| D1500-DIRBL | 13" x 20" Drop-in Meter Reader Plastic with Plastic Reader Cover – Water Meter | Black | 96 | 3.80 | 20ME |
| D1500-DICIR LD | 13" x 20" Drop-in Meter Reader Plastic with Cast Iron Reader Cover – Water Meter | Black | 96 | 5.00 | 20ME |
| Overlapping Cover Only | | | | | |
| D1500-OLSBL | 13" x 20" Jumbo Overlapping Solid Plastic Cover – Water Meter | Black | 96 | 3.80 | 20ME |
| D1500-OLRBL | 13" x 20" Overlapping Plastic Cover with Plastic Meter Reader – Water Meter | Black | 96 | 3.80 | 20ME |
| D1500-OLSGL | 13" x 20" Overlapping Plastic Cover with Plastic Meter Reader – Water Meter | Green | 96 | 3.80 | 20ME |
| Box Only | | | | | |
| D1500-B/O | 13" x 20" x 12" Jumbo Box | Black | 48 | 9.40 | 20ME |
| D1500-DUB/O | 13" x 20" x 12" Dual Pipe Slot Jumbo Box | Black | 48 | 8.91 | 20ME |
| D750E-EXT | 13" x 20" x 6" Extension Only | Black | 36 | 5.60 | 20ME |
| D1500-DICIRBLU | 13" x 20" Drop-in Meter Reader Cover, Blue Plastic with Cast Iron Reader Cover – Water Meter | Blue | 96 | 5.00 | 20ME |

METER BOXES

NDS METER BOXES – STANDARD COMMERCIAL GRADE

NDS D1800 Meter Boxes

Specifications: NDS 14" x 19" x 18" meter boxes and covers are injection molded of structural foam recycled polyolefin material with a melt index between 10-12. Coloring and UV stabilizers are added, along with processing lubricants when needed. The 14" x 19" body is tapered and has a minimum wall thickness of 0.250". The body has a double wall at the top cover seat area with a minimum thickness of 0.22". The cover seat area has 26 structural support ribs on the underside of the seat, each with a minimum thickness of 0.12". The bottom of the body has a 0.50" flange. The 14" x 19" cover has an average thickness of 0.20".

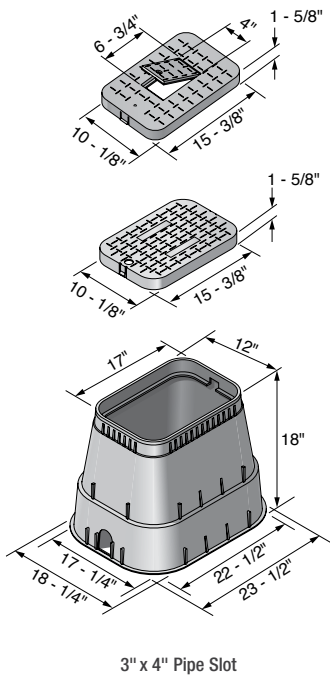

| Part No. | Description - Marking | Color (Box/Cover) | Pallet Qty. | Wt. Ea. lbs. | Product Class |
|--------------------------------|---|-------------------|-------------|--------------|---------------|
| Drop-in Box & Cover | | | | | |
| D1800-DISB | 14" x 19" x 18" Box, Drop-in Solid Plastic Cover - Water Meter | Black/Black | 48 | 12.20 | 20ME |
| D1800-DIRB | 14" x 19" x 18" Box, Drop-in Meter Reader Plastic w/ Plastic Reader Cover - Water Meter | Black/Black | 48 | 12.20 | 20ME |
| D1800-DICIR | 14" x 19" x 18" Box, Drop-in Meter Reader Plastic w/ Cast Iron Reader Cover - Water Meter | Black/Black | 48 | 13.40 | 20ME |
| Drop-in Cover Only | | | | | |
| D1200-DISBL | 14" x 19" Drop-in Box Solid Plastic Cover - Water Meter | Black | 216 | 2.20 | 20ME |
| D1200-DIRBL | 14" x 19" Drop-in Meter Reader w/ Plastic Reader Cover - Water Meter | Black | 216 | 2.20 | 20ME |
| D1200-DICIRLID | 14" x 19" Drop-in Meter Reader w/ Cast Iron Reader Cover - Water Meter | Black | 216 | 3.40 | 20ME |
| D1200-DISBSWRL | 14" x 19" Drop-in Solid Plastic Cover - Sewer | Black | 216 | 2.20 | 20ME |
| Overlapping Cover Only | | | | | |
| D1800-OLSG | 14" x 19" Overlapping Cover - ICV | Black/Green | 48 | 12.40 | 20ME |
| Box Only | | | | | |
| D1800-B/O | 14" x 19" x 18" Box | Black | 48 | 10.00 | 20ME |
| D1800-B/O NH | 14" x 19" x 18" Box, No Pipe Slots | Black | 48 | 10.00 | 20ME |
| D1800-B/O WHT | 14" x 19" Box | White | 48 | 10.00 | 20ME |

NDS METER BOXES – STANDARD COMMERCIAL GRADE

NDS D2400 Meter Boxes

Specifications: NDS 16" round meter pits and covers are injection molded of structural foam recycled polyolefin material with a melt index between 10-12. Coloring and UV stabilizers are added, along with processing lubricants when needed. The 16" round meter pit body is tapered and has a minimum wall thickness of 0.2615". The body has a double wall at the top cover seat area with a minimum thickness of 0.2780". The cover seat area has 8 structural support ribs on the underside of the seat, each with a minimum thickness of 0.0995". The bottom of the body has a 1/2" flange which flares to 1-1/4" at bolt hole. The 12-3/8" cover has an average thickness of 0.375".

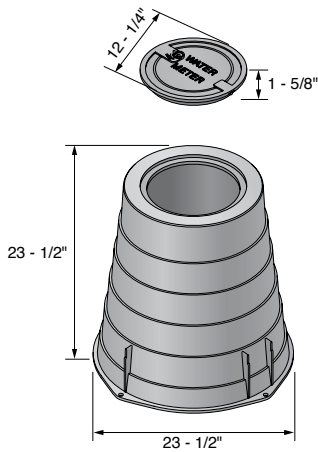

| Part No. | Description - Marking | Color (Box/Cover) | Pallet Qty. | Wt. Ea. lbs. | Product Class |
|------------------------|--|-------------------|-------------|--------------|---------------|
| Box & Cover | | | | | |
| D2400-18LOCSB | 18" Meter Pit, Overlapping Locking Solid Plastic Cover - Water Meter | Black/Black | 52 | 11.40 | 20ME |
| D2400-LOCSB | 24" Meter Pit, Overlapping Locking Solid Plastic Cover - Water Meter | Black/Black | 52 | 17.53 | 20ME |
| Cover Only | | | | | |
| D2400-LOCSWBL | Overlapping Locking Solid Plastic Cover - Water Meter | Black | 52 | 1.60 | 20ME |
| Box Only | | | | | |
| D2400-18 B/O | 18" Meter Pit | Black | 52 | 9.80 | 20ME |
| D2400-B/O | 24" Meter Box | Black | 52 | 14.00 | 20ME |

NDS Replacement Parts

| Part No. | Description - Marking | Color (Box/Cover) | Pallet Qty. | Wt. Ea. lbs. | Product Class |
|----------|-----------------------|-------------------|-------------|--------------|---------------|
| DKEY | Brass Locking Key | Brass | 1 | 0.50 | 20ME |

NDS PRO SERIES METER BOXES – PREMIUM COMMERCIAL GRADE

NDS 6" Round Meter Boxes

Specifications: The NDS 6" round meter boxes and covers are injection molded of structural foam polyolefin material with a melt index between 10-12. Coloring and UV stabilizers are added, along with processing lubricants when needed. The 6" round body is tapered and has a minimum wall thickness of 0.20". The body has a double wall at the top cover seat area with a minimum thickness of 0.13". The bottom of the body has a 0.250" flange. The 6" round cover has an average thickness of 0.187".

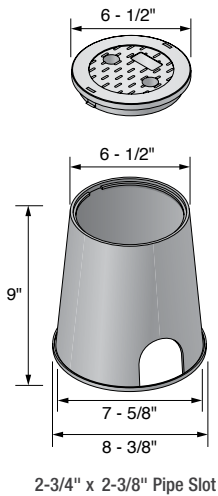

| Part No. | Description - Marking | Color (Box/Cover) | Pallet Qty. | Wt. Ea. lbs. | Product Class |
|------------------------|---|-------------------|-------------|--------------|---------------|
| Box & Cover | | | | | |
| 107BCW | 6" Round Box, Overlapping Solid Plastic Cover - Water Meter | Black/Green | 250 | 1.50 | 20NM |
| 107BCR | 6" Round Box, Overlapping Solid Plastic Cover - Reclaimed Water | Black/Purple | 250 | 1.50 | 20ND |
| 107PBCR | 6" Round Box, Overlapping Solid Plastic Cover - Reclaimed Water | Purple/Purple | 250 | 1.50 | 20ND |
| 107BCS | 6" Round Box, Overlapping Solid Plastic Cover - Sewer | Black/Green | 250 | 1.50 | 20NM |
| 208BCS | 6" Round Box, Round Overlapping Solid Plastic Cover - Sewer | Green/Green | 250 | 1.50 | 20PR |
| Cover Only | | | | | |
| 107CW | 6" Overlapping Solid Plastic Cover - Water Meter | Green | 800 | 0.40 | 20NM |
| 107CR | 6" Overlapping Solid Plastic Cover - Reclaimed Water | Purple | 800 | 0.40 | 20ND |
| 107CS | 6" Overlapping Solid Plastic Cover - Sewer | Green | 800 | 0.40 | 20NM |
| Box Only | | | | | |
| 107B | 6" Round Box | Black | 250 | 1.23 | 20ND |

NDS 10" Round Meter Boxes

Specifications: The NDS 10" round meter boxes and covers are injection molded of structural foam polyolefin material with a melt index between 10-12. Coloring and UV stabilizers are added, along with processing lubricants when needed. The 10" round body is tapered and has a minimum wall thickness of 0.30". The cover seat area has 8 structural support ribs on the underside of the seat, each with a minimum thickness of 0.250". The bottom of the body has a 0.50" flange. The 10" round cover has an average thickness of 0.30". The meter box has a 3/8" 304 Brass nut for the bolt-down as a standard feature.

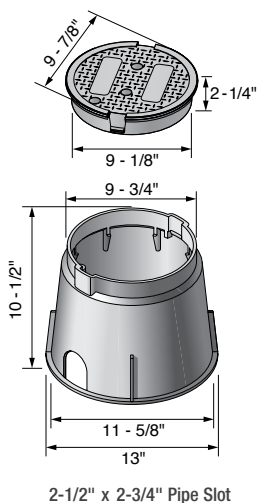

| Part No. | Description - Marking | Color (Box/Cover) | Pallet Qty. | Wt. Ea. lbs. | Product Class |
|------------------------|---|-------------------|-------------|--------------|---------------|
| Box & Cover | | | | | |
| 211PBCR | 10" Round Box, Overlapping Reclaimed Solid Plastic Cover - Water Meter | Purple/Purple | 120 | 4.50 | 20PR |
| 111BCS | 10" Round Box, Overlapping Solid Plastic Cover - Sewer | Black/Green | 180 | 3.00 | 20NM |
| 212BCS | 10" Round Box, Round Overlapping Solid Plastic Cover - Sewer | Green/Green | 120 | 4.50 | 20PR |
| 212BCBS | 10" Round Box, Round Overlapping Bolt-Down Solid Plastic Cover - Sewer | Green/Green | 120 | 4.50 | 20PR |
| 212BC ELEC | 10" Round Box, Overlapping Solid Plastic Cover - Electrical | Gray/Gray | 120 | 4.50 | 20PR |
| 212BCB ELEC | 10" Round Box, Overlapping Bolt-Down Solid Plastic Cover - Electrical** | Gray/Gray | 120 | 4.50 | 20PR |
| Cover Only | | | | | |
| 211CW | 10" Overlapping Water Solid Plastic Cover - Water Meter | Black | 200 | 1.34 | 20PR |
| 211CR | 10" Overlapping Reclaimed Solid Plastic Cover - Water Meter | Purple | 200 | 1.50 | 20PR |
| 111CS | 10" Round Overlapping Solid Plastic Cover - Sewer | Green | 300 | 1.00 | 20NM |
| 211CRG | 10" Round Overlapping Solid Plastic Cover - Reclaimed Water | Green | 200 | 1.34 | 20PR |
| 211CS | 10" Round Overlapping Solid Plastic Cover - Sewer | Green | 200 | 1.50 | 20PR |
| 211C ELEC | 10" Overlapping Solid Plastic Cover - Electrical | Gray | 200 | 1.50 | 20PR |
| Box Only | | | | | |
| 212B | 10" Round Box | Green | 120 | 3.00 | 20PR |
| 211BB | Bolt for 10" Cover | Steel | (Bag of 10) | 0.05 | 20PR |

**Note – Installer responsible for ensuring product meets local building/electrical code requirements.

NDS PRO SERIES METER BOXES – PREMIUM COMMERCIAL GRADE

NDS 14" x 19" Meter Boxes

Specifications: The NDS 14" x 19" meter boxes and covers are injection molded of structural foam polyolefin material with a melt index between 10-12. Coloring and UV stabilizers are added, along with processing lubricants when needed. The 14" x 19" body is tapered and has a minimum wall thickness of 0.250". The body has a double wall at the top cover seat area with a minimum thickness of 0.250". The cover seat area has 16 structural support ribs on the underside of the seat, each with a minimum thickness of 0.250". The bottom of the body has a 0.50" flange. The 12" x 20" cover shall have an average thickness of 0.250". The meter box has a 3/8" 304 Brass nut for the bolt-down as a standard feature.

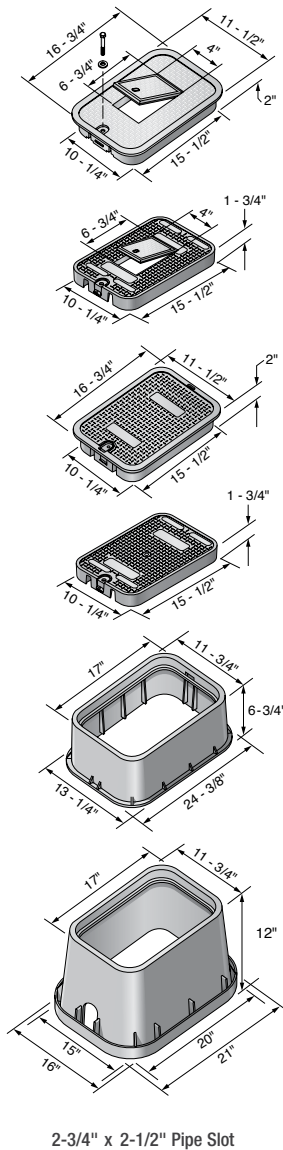

| Part No. | Description - Marking | Color (Box/Cover) | Pallet Qty. | Wt. Ea. lbs. | Product Class |
|------------------------------------|---|-------------------|-------------|--------------|---------------|
| Drop-in Box & Cover | | | | | |
| 113BCDW | 14" x 19" x 12" Box, Drop-in Solid Plastic Cover - Water Meter | Black/Black | 78 | 8.00 | 20NM |
| 113BCDS | 14" x 19" x 12" Box, Drop-in Solid Plastic Cover - Sewer | Black/Green | 78 | 8.00 | 20NM |
| 113BCDMCIF | 14" x 19" x 12" Box, Drop-in Meter Reader Plastic w/ Cast Iron Reader Cover - Water Meter | Black/Black | 78 | 12.00 | 20NM |
| Overlapping Box & Cover | | | | | |
| 113BCW | 14" x 19" x 12" Box, Overlapping Solid Plastic Cover - Water Meter | Black/Black | 78 | 9.32 | 20NM |
| 113BCS | 14" x 19" x 12" Box, Overlapping Solid Plastic Cover - Sewer | Black/Green | 78 | 9.32 | 20NM |
| 113BCE | 14" x 19" x 12" Box, Overlapping Solid Plastic Cover - Electrical | Green/Green | 78 | 9.32 | 20NM |
| 113BCR | 14" x 19" x 12" Box, Overlapping Solid Plastic Cover - Reclaimed Water | Black/Purple | 78 | 9.10 | 20ND |
| 113PBCR | 14" x 19" x 12" Box, Overlapping Solid Plastic Cover - Reclaimed Water | Purple/Purple | 78 | 9.29 | 20ND |
| 113BCM | 14" x 19" x 12" Box, Overlapping Meter Reader Plastic w/ Plastic Reader Cover - Water Meter | Black/Black | 78 | 8.92 | 20NM |
| 113BCMCIF | 14" x 19" x 12" Box, Overlapping Meter Reader Plastic w/ Cast Iron Reader Cover - Water Meter | Black/Black | 78 | 9.38 | 20NM |
| 213PBCR | 14" x 19" Box, Overlapping Solid Plastic Cover - Reclaimed Water | Purple/Purple | 78 | 9.00 | 20PR |
| 214BCS | 14" x 19" Box, Overlapping Solid Plastic Cover - Sewer | Green/Green | 78 | 9.00 | 20PR |
| 214BCB ELEC | 14" x 19" Box, Overlapping Bolt-Down Solid Plastic Cover - Electrical** | Gray/Gray | 78 | 9.00 | 20PR |
| Drop-in Cover Only | | | | | |
| 113CDMCIF | 14" x 19" Drop-in Meter Reader Plastic w/ Cast Iron Reader Cover - Water Meter | Black | 300 | 3.80 | 20NM |
| Overlapping Cover Only | | | | | |
| 113CW | 14" x 19" Overlapping Solid Plastic Cover - Water Meter | Black | 300 | 2.30 | 20NM |
| 114CW | 14" x 19" Overlapping Solid Plastic Cover - Water Meter | Green | 300 | 2.30 | 20NM |
| 113CR | 14" x 19" Overlapping Solid Plastic Cover - Reclaimed Water | Purple | 300 | 2.50 | 20ND |
| 113CE | 14" x 19" Overlapping Solid Plastic Cover - Electric | Green | 300 | 2.30 | 20NM |
| 113CM | 14" x 19" Overlapping Meter Reader Plastic w/ Plastic Reader Cover - Water Meter | Black | 300 | 2.50 | 20NM |
| 113CMCIF | 14" x 19" Overlapping Meter Reader Plastic w/ Cast Iron Reader Cover - Water Meter | Black | 300 | 3.65 | 20NM |
| 213CS | 14" x 19" Overlapping Solid Plastic Cover - Sewer | Green | 300 | 2.50 | 20PR |
| 213C ELEC | 14" x 19" Overlapping Solid Plastic Cover - Electrical** | Gray | 300 | 2.50 | 20PR |
| Box Only | | | | | |
| 113B | 14" x 19" x 12" Box | Black | 78 | 6.00 | 20NM |
| 113-6 | 14" x 19" x 6" Extension | Black | 49 | 4.00 | 20ND |
| 114-6 | 14" x 19" x 6" Extension | Green | 49 | 3.86 | 20ND |
| 113BB | 2-1/2" x 3/8" SS Bolt | Steel | (Bag of 10) | 0.10 | 20NM |

**Note – Installer responsible for ensuring product meets local building/electrical code requirements.

NDS PRO SERIES METER BOXES – PREMIUM COMMERCIAL GRADE

NDS 13" x 20" Meter Boxes

Specifications: The NDS 13" x 20" meter boxes and covers are injection molded of structural foam polyolefin material with a melt index between 10-12. Coloring and UV stabilizers are added, along with processing lubricants when needed. The 13" x 20" body is tapered and has a minimum wall thickness of 0.250". The body has a double wall at the top cover seat area with a minimum thickness of 0.250". The cover seat area has 16 structural support ribs on the underside of the seat, each with a minimum thickness of 0.250". The bottom of the body has a 0.50" flange. The 13" x 20" cover has an average thickness of 0.250". The meter box has a 3/8" 304 Brass nut for the bolt-down as a standard feature.

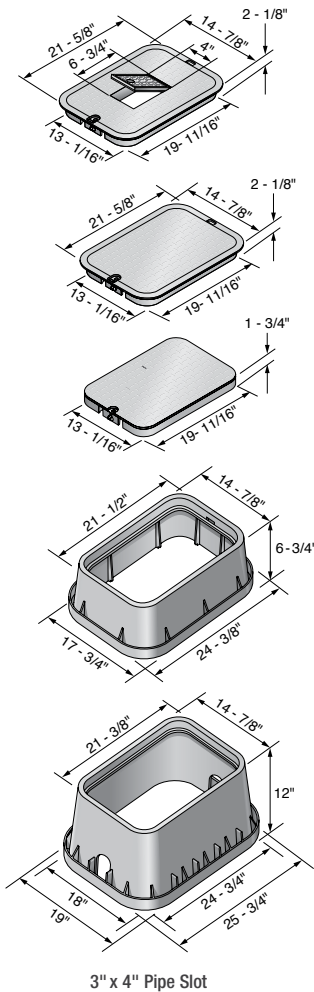

| Part No. | Description - Marking | Color (Box/Cover) | Pallet Qty. | Wt. Ea. lbs. | Product Class |
|------------------------------------|---|-------------------|-------------|--------------|---------------|
| Drop-in Box & Cover | | | | | |
| 117BCDW | 13" x 20" x 12" Box, Drop-in Solid Plastic Cover - Water | Black/Black | 56 | 13.25 | 20NM |
| 117DBCDCIF | 13" x 20" x 12" Dual Outlet Box, Drop-in Meter Reader Plastic w/ Cast Iron Reader Cover - Water Meter | Black/Black | 56 | 14.50 | 20NM |
| Overlapping Box & Cover | | | | | |
| 117BCS | 13" x 20" x 12" Box, Overlapping Solid Plastic Cover - Sewer | Black/Green | 56 | 14.00 | 20NM |
| 117B12CW | 13" x 20" x 12" Valve Box with Overlapping Cover - Water | Black | 56 | 14.00 | 20NM |
| 217PBCR | 13" x 20" Jumbo Box, Overlapping Solid Plastic Cover - Reclaimed Water | Purple | 56 | 13.69 | 20PR |
| 218BCS | 13" x 20" Jumbo Box, Overlapping Solid Plastic Cover - Sewer | Green/Green | 56 | 14.00 | 20PR |
| Drop-in Cover Only | | | | | |
| 117CDMCIF | 13" x 20" Drop-in Meter Reader Plastic w/ Cast Iron Reader Cover - Water Meter | Black | 180 | 7.50 | 20NM |
| Overlapping Cover Only | | | | | |
| 117CW | 13" x 20" Overlapping Solid Plastic Cover - Water Meter | Black | 180 | 5.00 | 20NM |
| 117CS | 13" x 20" Overlapping Solid Plastic Cover - Sewer | Green | 180 | 5.00 | 20NM |
| 217CR | 13" x 20" Jumbo Overlapping Solid Plastic Cover - Reclaimed Water | Purple | 180 | 4.51 | 20PR |
| Box Only | | | | | |
| 117B | 13" x 20" x 12" Box, Single Inlet, Single Outlet | Black | 56 | 8.14 | 20NM |
| 117-6 | 13" x 20" Jumbo Extension | Black | 32 | 6.88 | 20ND |
| 113BB | 2-1/2" x 3/8" SS Bolt | Steel | (Bag of 10) | 0.10 | 20NM |

NDS PRO SERIES METER BOXES – PREMIUM COMMERCIAL GRADE

NDS 13" x 24" Meter Boxes

Specifications: The NDS 13" x 24" meter boxes and covers are injection molded of structural foam polyolefin material with a melt index between 10-12. Coloring and UV stabilizers are added, along with processing lubricants when needed. The 13" x 24" body is tapered and has a minimum wall thickness of 0.27". The body has a double wall at the top cover seat area with a minimum thickness of 0.27". The cover seat area has 18 structural support ribs on the underside of the seat, each with a minimum thickness of 0.250". The bottom of the body has a 1" flange. The 13" x 24" cover has an average thickness of 0.32". The meter box has a 3/8" 304 Brass nut for the bolt-down as a standard feature.

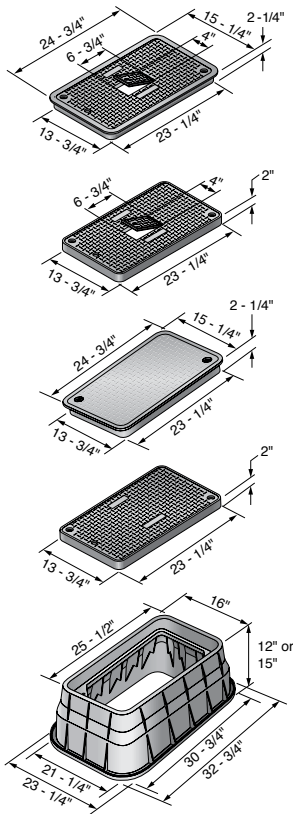

| Part No. | Description - Marking | Color (Box/Cover) | Pallet Qty. | Wt. Ea. lbs. | Product Class |
|--|---|-------------------|-------------|--------------|---------------|
| Drop-in Box & Cover | | | | | |
| 121BCDWB | 13" x 24" x 12" Box, Bolt-Down Drop-in Solid Plastic Cover - Water Meter | Black/Black | 12 | 22.78 | 20NM |
| 121BCDMCIFB | 13" x 24" x 15" Box, Bolt-Down Drop-in Meter Reader Plastic w/ Cast Iron Reader Cover - Water Meter | Black/Black | 12 | 23.13 | 20NM |
| 125BCDMCIFB | 13" x 24" x 12" Box, Bolt-Down Drop-in Meter Reader Plastic w/ Cast Iron Reader Cover - Water Meter | Black/Black | 12 | 26.13 | 20NM |
| **Note – Installer responsible for ensuring product meets local building/electrical code requirements. Insulate bolt with 1/2" x 2-3/4" heat shrink tube and/or a ground rod clamp (such as Thomas & Betts Part Number 63) to reduce the chance of electrical shock. | | | | | |
| Overlapping Box & Cover | | | | | |
| 125PBCRB | 13" x 24" x 15" Box, Bolt-Down Overlapping Solid Plastic Cover - Reclaimed Water | Purple/Purple | 12 | 26.44 | 20ND |
| Drop-in Cover Only | | | | | |
| 121CDM | 13" x 24" Drop-in Meter Reader Plastic w/ Plastic Reader Cover - Water Meter | Black | 125 | 5.81 | 20NM |
| 121CDMCI | 13" x 24" Drop-in Meter Reader Plastic w/ Cast Iron Reader Cover - Water Meter | Black | 125 | 7.13 | 20NM |
| Box Only | | | | | |
| 125B | 13" x 24" x 15" Box | Black | 12 | 19.00 | 20NM |

**Note – Installer responsible for ensuring product meets local building/electrical code requirements.

NDS PRO SERIES METER BOXES – PREMIUM COMMERCIAL GRADE

NDS 17" x 30" Meter Boxes

Specifications: The NDS 17" x 30" meter boxes and covers are injection molded of structural foam polyolefin material with a melt index between 10-12. Coloring and UV stabilizers are added, along with processing lubricants when needed. The 17" x 30" body is tapered and has a minimum wall thickness of 0.32". The body has a double wall at the top cover seat area with a minimum thickness of 0.32". The cover seat area has 20 structural support ribs on the underside of the seat, each with a minimum thickness of 0.250". The bottom of the body has a 1" flange. The 17" x 30" cover has an average thickness of 0.35". The meter box has a 3/8" 304 SS Brass for the bolt-down as a standard feature.

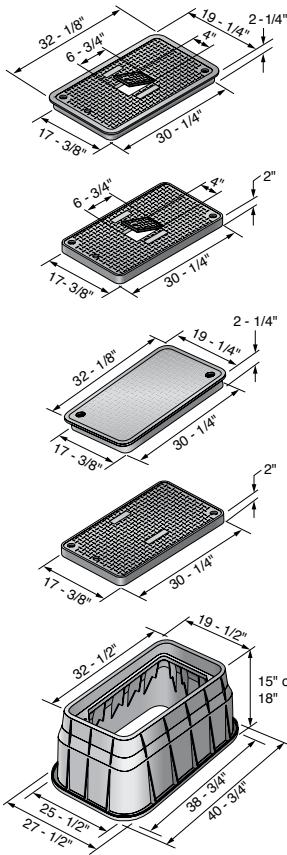

| Part No. | Description - Marking | Color (Box/Cover) | Pallet Qty. | Wt. Ea. lbs. | Product Class |
|--------------------------------|--|-------------------|-------------|--------------|---------------|
| Drop-in Box & Cover | | | | | |
| 124BCDWB | 17" x 30" x 15" Box, Bolt-Down Drop-in Solid Plastic Cover - Water Meter | Black/Black | 12 | 34.70 | 20NM |
| 126BCDWB | 17" x 30" x 18" Box, Bolt-Down Drop-in Solid Plastic Cover - Water Meter | Black/Black | 10 | 37.65 | 20NM |
| 126BCDMB | 17" x 30" x 18" Box, Bolt-Down Drop-in Plastic w/ Plastic Reader Cover - Water Meter | Black/Black | 10 | 41.00 | 20NM |
| 124BCDMCIFB | 17" x 30" x 15" Box, Bolt-Down Drop-in Plastic w/ Cast Iron Reader Cover - Water Meter | Black/Black | 12 | 33.70 | 20NM |
| 126BCDMCIFB | 17" x 30" x 18" Box, Bolt-Down Drop-in Plastic w/ Cast Iron Reader Cover - Water Meter | Black/Black | 10 | 37.65 | 20NM |
| 226BCDB ELEC | 17" x 30" x 18" Box, Bolt-Down Drop-in Solid Plastic Cover - Electric** | Gray/Gray | 10 | 37.05 | 20PR |
| Overlapping Cover Only | | | | | |
| 223CR | 17" x 30" Overlapping Solid Plastic Cover - Reclaimed Water | Purple | 75 | 11.60 | 20ND |
| Drop-in Cover Only | | | | | |
| 123CDMCF | 17" x 30" Drop In Cover with Cast Iron Meter Reader | Black | 75 | 10.30 | 20NM |
| 123CDW | 17" x 30" Drop in Cover - Water | Black | 75 | 1.50 | 20NM |
| Box Only | | | | | |
| 124B | 17" x 30" x 15" Box | Black | 12 | 20.00 | 20NM |
| 126B | 17" x 30" x 18" Box | Black | 10 | 23.80 | 20NM |

**Note – Installer responsible for ensuring product meets local building/electrical code requirements.

METER BOXES PRODUCT INDEX

| Part No. | Page | Part No. | Page | Part No. | Page | Part No. | Page | Part No. | Page |
|------------|----------|-------------|------|--------------------|----------|----------------|---------------|----------------|----------|
| 107B | 216 | 117CW | 218 | 218BCS | 218 | D1200-CIL | 212 | D1200-OLSGL | 212 |
| 107BCR | 216 | 117BCDMCIF | 218 | 223CR | 220 | D1200-DIBLRD | 211 | D1200-OLTR | 207 |
| 107BCS | 216 | 121BCDMCIFB | 219 | 226BCDB ELEC | 220 | D1200-DIBLRDL | 212 | D1200P-DICIRP | 211 |
| 107BCW | 216 | 121BCDWB | 219 | D12AMR-OLLOCL | 207 | D1200-DICIR | 211 | D1500-B/O | 209, 213 |
| 107CR | 216 | 121CDM | 219 | D12AMR-OLLOCTRBLUL | 207 | D1200-DICIRBLU | 208 | D1500-DICIR | 213 |
| 107CS | 216 | 121CDMCIF | 219 | D12AMR-OLLOCTRL | 207 | D1200-DICIRLID | 208, 212, 214 | D1500-DICIRBLU | 213 |
| 107CW | 216 | 123CDMCIF | 220 | D12-BAMR | 207 | D1200-DIRB | 211 | D1500-DICIR LD | 213 |
| 107PBCR | 216 | 123CDW | 220 | D12-BAMRL | 207 | D1200-DIRBL | 208, 212, 214 | D1500-DIRB | 213 |
| 111BCS | 216 | 124B | 220 | D12-TAMR | 207 | D1200-DIRG | 211 | D1500-DIRBL | 213 |
| 111CS | 216 | 124BCDMCIFB | 220 | D12-TAMRBLUL | 207 | D1200-DISB | 211 | D1500-DIRBLU | 213 |
| 113-6 | 217 | 124BCDWB | 220 | D12-TAMRL | 207 | D1200-DISBL | 208, 212, 214 | D1500-DISB | 213 |
| 113B | 217 | 125B | 219 | D15AMR2-B/O | 208 | D1200-DISBLU | 211 | D1500-DISBL | 213 |
| 113BB | 217, 218 | 125BCDMCIFB | 219 | D15AMR2-DI | 208 | D1200-DISBLUL | 211 | D1500-DISBTR | 209 |
| 113BCDMCIF | 217 | 125PBCRB | 219 | D15AMR2-DU B/O | 208 | D1200-DISBSWR | 211 | D1500-DUB/O | 209, 213 |
| 113BCDS | 217 | 126B | 220 | D15AMR2-OLLOC | 208 | D1200-DISBSWRL | 212, 214 | D1500-DUDICIR | 213 |
| 113BCDW | 217 | 126BCDMB | 220 | D15AMR2-OLR | 208 | D1200-DISGL | 212 | D1500-DUDIRB | 213 |
| 113BCE | 217 | 126BCDMCIFB | 220 | D15AMR2-PS B/O | 208 | D1200-DISGSWR | 211 | D1500-DUDISB | 213 |
| 113BCM | 217 | 126BCDWB | 220 | D15-BAMR | 209 | D1200-DISGSWRL | 212 | D1500-OLRB | 213 |
| 113BCMCIF | 217 | 208BCS | 216 | D15-BAMRL | 209 | D1200-DITR | 207 | D1500-OLRBL | 213 |
| 113BCR | 217 | 211BB | 216 | D15-BAMRLP-AM | 209 | D1200-DITRL | 207 | D1500-OLSB | 213 |
| 113BCS | 217 | 211C ELEC | 216 | D15-BAMRP | 209 | D1200-DUB/O | 212 | D1500-OLSBL | 213 |
| 113BCW | 217 | 211CR | 216 | D15DU-BAMR | 209 | D1200-DUDICIR | 211 | D1500-OLSGL | 213 |
| 113CDMCIF | 217 | 211CRG | 216 | D109-B | 210 | D1200-DUDIRB | 211 | D1500P-DU-DICP | 213 |
| 113CE | 217 | 211CS | 216 | D109-B/O | 210 | D1200-DUDISB | 211 | D1800-B/O | 207, 214 |
| 113CM | 217 | 211CW | 216 | D109-P | 210 | D1200-DUOLSB | 212 | D1800-B/O NH | 214 |
| 113CMCIF | 217 | 211PBCR | 216 | D109-PL | 210 | D1200G-B/O | 212 | D1800-B/O WHT | 214 |
| 113CR | 217 | 212B | 216 | D600E-DISG | 207 | D1200G-DISGSWR | 211 | D1800-DICIR | 214 |
| 113CW | 217 | 212BCB ELEC | 216 | D600E-EXT | 207, 212 | D1200-OLBLL | 212 | D1800-DIRB | 214 |
| 113PBCR | 217 | 212BCBS | 216 | D750E-EXT | 209, 213 | D1200-OLCIR | 212 | D1800-DISB | 214 |
| 114-6 | 217 | 212BC ELEC | 216 | D1000-RB | 210 | D1200-OLCIR LD | 212 | D1800-OLSG | 214 |
| 114CW | 217 | 212BCS | 216 | D1000-RBL | 210 | D1200-OLCIRSS | 212 | D2400-18 B/O | 215 |
| 117-6 | 218 | 213C ELEC | 217 | D1000-SB | 210 | D1200-OLLOCB | 212 | D2400-18LOCSB | 215 |
| 117B | 218 | 213CS | 217 | D1000-SBL | 210 | D1200-OLLOCBLD | 208, 212 | D2400-B/O | 215 |
| 117B12CW | 218 | 213PBCR | 217 | D1100-SPL | 210 | D1200-OLRB | 212 | D2400-LOCSB | 215 |
| 117BCDW | 218 | 214BCB ELEC | 217 | D1200-B/O | 207, 212 | D1200-OLRBLU | 212 | D2400-LOCSWBL | 215 |
| 117BCS | 218 | 214BCS | 217 | D1200-CI | 212 | D1200-OLRBLUL | 212 | DKEY | 215 |
| 117CDMCIF | 218 | 217CR | 218 | D1200-CICIR | 212 | D1200-OLSB | 212 | | |
| 117CS | 218 | 217PBCR | 218 | D1200-CICIR LD | 212 | D1200-OLSBL | 208, 212 | | |

You Click, You Order. No Waiting.

Getting connected is easy... set up your account online, or call customer service. 800-7261994. Se Habla Español.

ndspro.net

The 24 hour online dealer tool that helps you manage your NDS Business

Pricing Query

Instant Order Entry, No Wait

Check Discount Schedules

Check Order Status

Invoice Printing

Inventory Query

Manage Your Account

News Updates

Links to ndspro.com and Literature Direct



NEW! Shopping Cart
Easy to Use & Convenient



TERMS AND CONDITIONS OF SALE

Terms: Standard terms are NET 30 days. All invoices are to be paid in US Currency. Title and risk of loss pass to buyer upon shipment.

Freight Allowance: Freight prepaid on orders of \$1250.00 NET or more, with the exception of shipments to HI, Canada, AK, and PR Prepaid freight levels are based on shipments to one location only. It is the responsibility of the customer to determine if his purchase order meets the minimum freight allowance required. NDS reserves the right to select the carrier and point of shipment.

Canada, Hawaii, Puerto Rico & Alaska orders that include EZflow must be a minimum of \$4000 for prepaid freight Terms.

Canada, Puerto Rico & Alaska: Freight prepaid on orders of \$2500.00 (US\$) NET or more.

Hawaii Orders: Freight prepaid on orders of \$3500 NET or more.

Errors & Claims: All claims for shortage in shipment or damaged material must be noted on the “Bill of Lading” and a written request for credit submitted to NDS within 15 days of shipment. NDS responsibility ceases upon delivery to the carrier.

Returned Goods: Returned goods will be accepted only after written approval and shipping instructions are received from NDS. A return goods authorization number is required and must be on all cartons, documents, and correspondence. All returns are subject to a 25% restocking charge, freight cost of returned goods (plus “out freight if applicable”). A higher restocking charge may be assessed against any return requiring extraordinary handling costs.

Minimum Order: \$100.00 minimum order net billing.

Broken Box Charge: A 25% broken box charge will be added for other than full box quantities. 21DI Drip Components, 25DS Dura Slope Channel and 25FC Filcoten Channel are excluded from this policy.

Limited One Year Warranty: The liabilities of NDS are limited solely and exclusively to replacement as set forth in our standard “Statement of Warranty”, alone and do not include any liability for incidental, consequential or other damage of any kind whatsoever, whether any claim is based upon theories of contract, warranty, negligence or tort and without any limitations and do not include shipping charges, labor, installation or any other losses or expenses incurred in operation of any replacement specialty item or fitting. NDS drainage products are designed to be used for exterior surface drainage only.

Limited Lifetime Warranty: NDS warrants to the original owner of its NDS catch basins, grates, channel and Pro Series valve boxes, subject to the conditions set forth in this warranty, that NDS catch basins, grates, channel and Pro Series valve boxes will remain free from manufacturing defects.

All NDS products are guaranteed against defects resulting from faulty workmanship or materials. Claims for labor costs and other expenses required to replace defective products or repair of any damage resulting from the use thereof will not be allowed by NDS. Our liability is limited to replacement of products acknowledged by NDS to be defective.

Exclusive Warranties and Remedies: The foregoing remedies are exclusive and are given and accepted in lieu of (i) any and all other warranties, express or implied, including without limitation the implied warranties of merchantability and fitness for particular purpose; and (ii) any obligation, liability, right, claim or remedy in contract or tort, whether or not arising from NDS, Inc.’s negligence, actual or imputed. The remedies of customer shall be limited to those provided herein to the exclusion of any and all other remedies including, without limitation, incidental or consequential damages. No agreement varying or extending the foregoing warranties or these limitations will be binding on NDS, Inc., unless such is signed in writing by an authorized officer of NDS, Inc.

The liability of NDS, Inc., hereunder shall be limited to restoring to good working order, provided that NDS, Inc., is not required to restore the product to good working order when such failure is due to causes beyond NDS, Inc.’s control, including but not limited to, acts of God, acts of civil or military authority, priorities, strikes, floods, epidemics, war, riots, and other causes that are beyond the manufacturers control.

These provisions are complete and exclusive statements of all terms and conditions between NDS, Inc., and the consumer. These provisions may not be varied, supplemented, qualified or interpreted by any prior course of dealings, written or oral or by trade usage. No NDS, Inc. agent, officer or employee has authority to make any representation, promise or warranty concerning these provisions.

FOR TECHNICAL INFORMATION, CONTACT: Technical Services, (888) 825-4716, TechService@ndspro.com

Visit ndspro.com for more information.



Our products are engineered and produced for performance, durability, ease of installation and the efficient use of resources.

California Prop 65 Warning

To meet the requirements of California Proposition 65, it is our responsibility to inform you of the following:

Warning Some products sold contain chemicals known to the state of California to cause cancer, birth defects, or other reproductive harm. For more information, please go to www.P65Warnings.ca.gov

ndspro.com

NDS Customer Service
851 N. Harvard Ave., Lindsay, CA 93247
Phone: 800.726.1994 · 559.562.9888
Press 2 for Customer Service or 3 for Technical Support
Fax: 800.726.1998 · 559.562.4488
Se Habla Español

**Download our
Mobile App - Search
for NDS Drainage**



A Proud Member of



Visit ndspro.com for:



Videos



Tools/
Calculators



Downloads



Case
Studies



Design
Worx



Request
a Quote