



Underscore® | K-1956-RA

60" x 30" alcove bath right drain

Features

- Integral lumbar support
- Slotted overflow allows for deep soaking
- Integral apron creates a clean, finished look
- Integral flange helps prevent water from seeping behind wall and simplifies alcove installation
- Textured bottom surface



Available Colors/Finishes

Color tiles intended for reference only.

- 0 White
- 96 Biscuit
- 7 Black Black



1-800-4KOHLER (1-800-456-4537)
Kohler Co. reserves the right to make revisions without notice to product specifications.
For the most current specification sheet, go to www.kohler.com USA or www.kohler.ca Canada.
3-27-2026 18:31 - US-CA

THE BOLD LOOK
OF **KOHLER**

Codes/Standards

CSA B45.5/IAPMO Z124
 ASTM E162
 ASTM E662

Technical Information

All product dimensions are nominal.

Drain Location:	Right
Drain Hole Diameter:	2-1/4" (57 mm)
Minimum Flat for Door:	2-13/16" (72 mm)
Basin Area, Bottom:	46-1/4" x 22" (1175 mm x 559 mm)
Basin Area, Top:	52" x 24" (1321 mm x 610 mm)
Water Depth:	15-1/2" (394 mm)
Water Capacity:	68 gal (257.4 L)
Minimum Floor Load:	56 lbs/ft ²
Weight:	105 lbs (47.6 kg)

Material

- Acrylic

Recommended Products/Accessories

K-23726 Drain treatment

K-23732 Tub & shower cleaner

K-31795 Slotted overflow bath drain kit for above-the-floor installations

K-31797 Slotted overflow bath drain kit

Warranty

See website for detailed warranty information.

KOHLER® Plastic Baths and Shower Bases Lifetime Limited Warranty



No change in measurements if connected with drain illustrated. (K-7272)

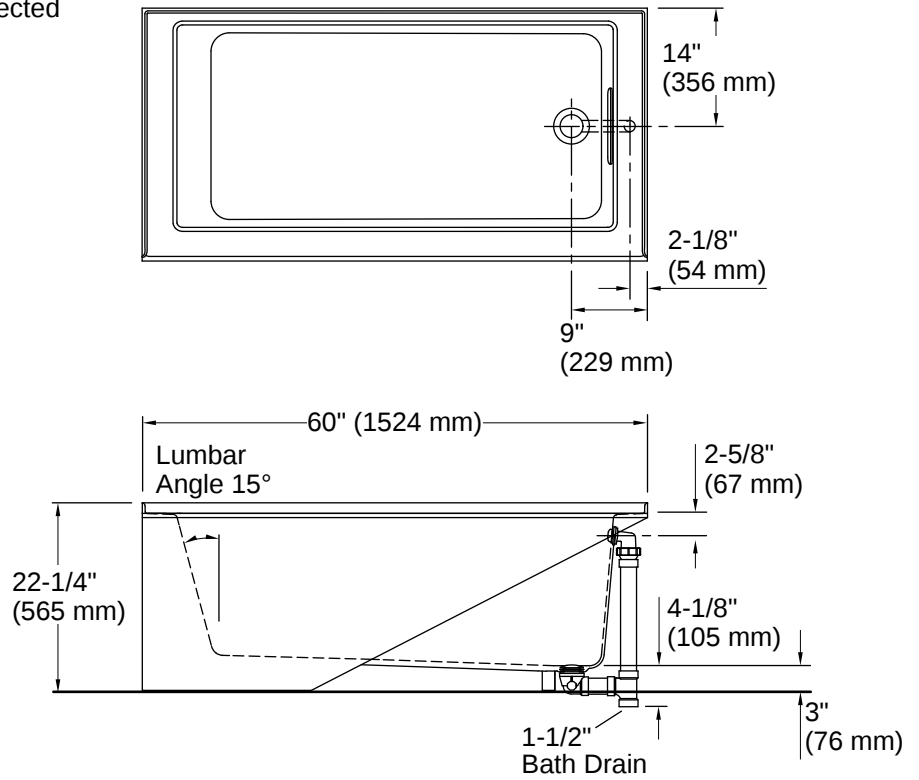
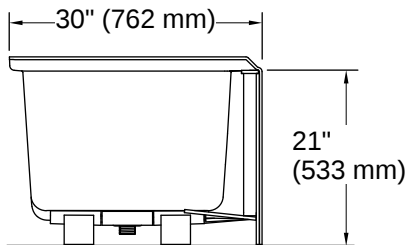
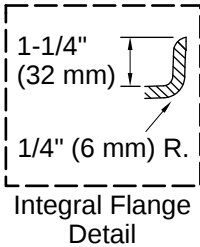

Installation

- Right drain
- Requires Clearflo slotted overflow bath drain (sold separately)
- Alcove

Installation Notes

Install this product according to the installation instructions.

Measure your actual product for rough-in details.

The hot water supply should be 70% of the capacity of the bath or greater. Installations will vary.

