

INSTALLATION AND MAINTENANCE



MODEL: KRF-24V-KIT

**Wireless 24V Multi-System RF Thermostat Kit
For 24V HVAC Control**



KRFTP-B: RF Thermostat



KRFR-24V: 24V HVAC Relay

⚠ DANGER ⚠

ELECTRIC SHOCK OR FIRE HAZARD

READ ALL WIRE SIZING, VOLTAGE REQUIREMENTS AND SAFETY DATA TO AVOID PROPERTY DAMAGE AND PERSONAL INJURY

READ CAREFULLY - These instructions will help prevent difficulties that might arise during thermostat installation. Studying the instructions first may save considerable time and money later. Observing the following procedures will keep installation time to a minimum. Save these instructions for future use.

KRF-24V-KIT SYSTEM DIAGRAM W/ OPTIONAL SENSORS

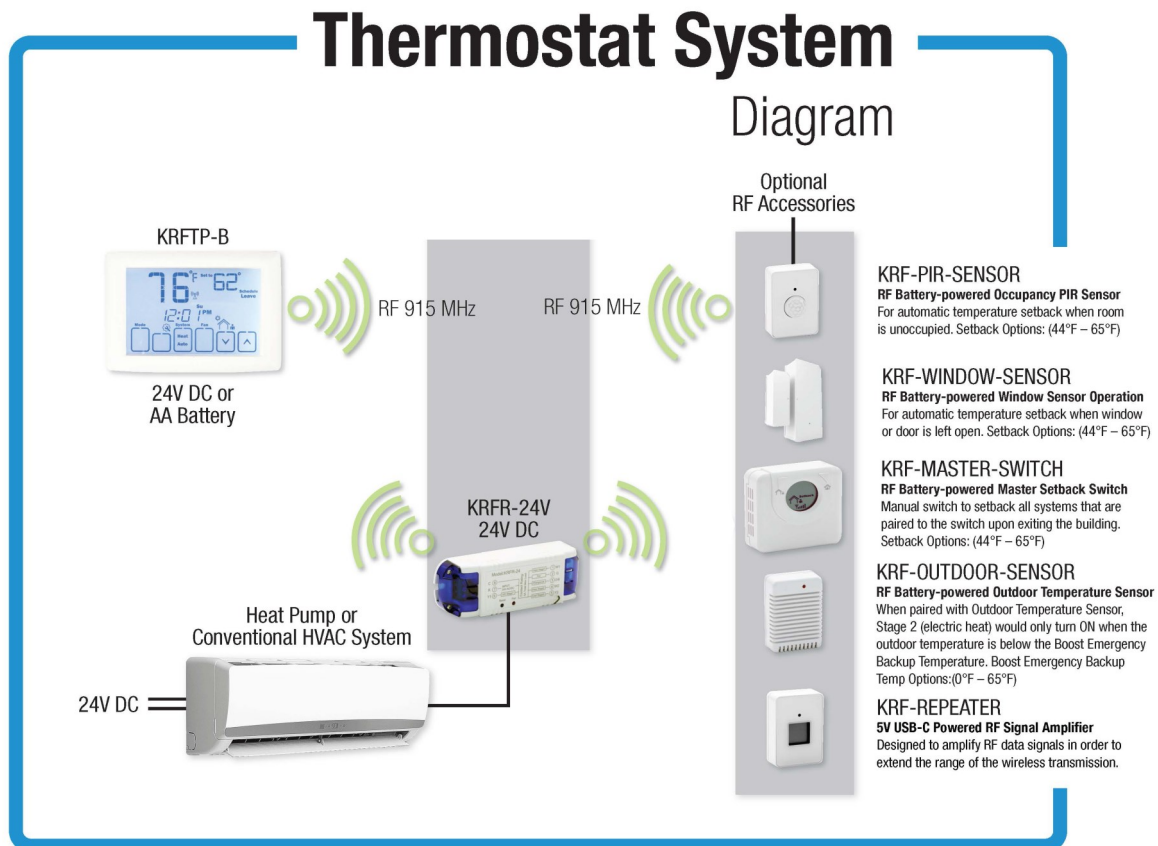

GETTING TO KNOW YOUR THERMOSTAT

ALL SYSTEM ICONS DIAGRAM

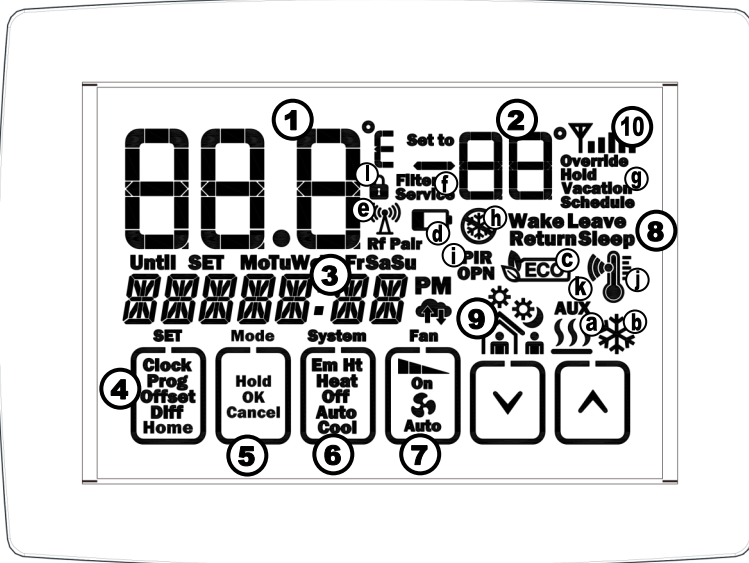

KRFTP-B: RF Thermostat

1. Current Room Temperature
2. Setpoint: User Defined setpoint temperature
3. Time & Day Of The Week
4. Set/Program Menu Button: Show different options during programming.
5. MODE/HOLD Button: Displays HOLD when permanent hold is set.
6. System Button: COOL, HEAT, AUTO, EM HT (emergency heat) or OFF icon will display based on the current mode.
7. Fan Button: ON, FAN or AUTO icon will display based on the current fan mode.
8. Setback Mode - WAKE, LEAVE, RETURN, or SLEEP icon will display based on current setback period.
9. Period Icons - WAKE, LEAVE, RETURN, or SLEEP icon will display based on the current period.
10. Signal Indicator - Strength of RF signal from relays.
 - a. Heat Active Icon
 - b. Cooling Active Icon
 - c. ECO Setback Icon
 - d. Battery Indicator
 - e. RF Signal Indicator
 - f. Change Filter Reminder Icon
 - g. Status Icons—OVERRIDE, HOLD, VACATION or SCHEDULE icon displays based on current status.
 - h. Freeze Protection Mode Icon
 - i. Window/Door Open or PIR Room Unoccupied Icon
 - j. Electric/Emergency Heat Active Icon
 - k. AUX: Second Stage Heating/Cooling Active Icon
 - l. Display Lock Icon

HOME SCREEN DIAGRAM

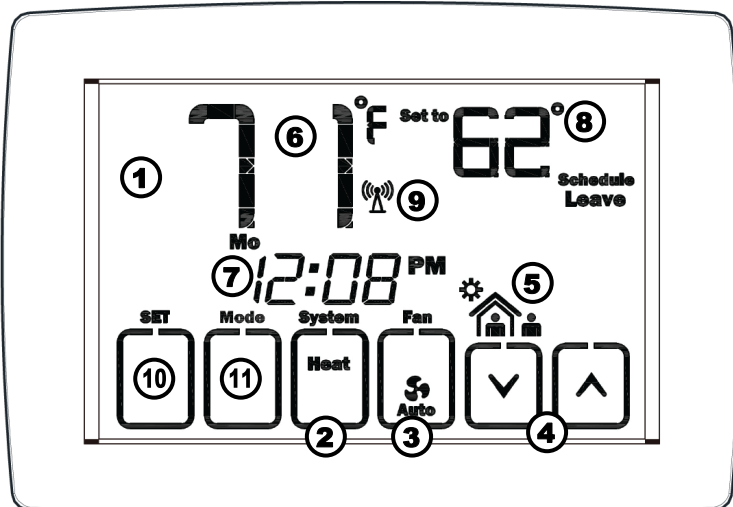

KRFTP-B: RF Thermostat

1. Touch Screen LCD Display
2. System Mode Button
3. Fan Mode Button
4. Up & Down Buttons
5. Period Icons
6. Current Room Temperature
7. Current Day & Time
8. Temperature Setpoint
9. RF Signal Connection Icon
10. Set/Program Menu Options Button
11. Mode Button (Hold)

INSTALLATION AND MAINTENANCE

APPLICATION GUIDE

Description	
Gas or Oil Heat	Yes
Electric Furnace	Yes
Heat Pump (No Aux. or Emergency Heat)	Yes
Heat Pump (With Aux. or Emergency Heat)	Yes
Multi-Stage Systems	Yes
Cool Only Systems	Yes
Millivolt	No
Humidity	No
Dual Fuel	No

Warning:

A trained, experienced technician must install this product.

Carefully read these instructions. You could damage this product or cause a hazardous condition if you fail to follow these instructions.

POWER TYPE

KRFTP-B: RF Thermostat

1. Battery Power*
2. Hardwire (Common Wire)
3. Hardwire (Common Wire) w/ Battery Backup

KRFR-24V: HVAC Relay

1. Hardwire (Common Wire)

Main Components	Description
KRFTB-B	RF 24V Thermostat
KRFR-24V	RF24V Heat Pump Relay

Optional Accessories	Description
KRF-PIR-SENSOR	RF Battery-powered Occupancy PIR Sensor
KRF-WINDOW-SENSOR	RF Battery-powered Window/Door Sensor Operation
KRF-MASTER-SWITCH	RF Battery-powered Master Setback Switch
KRF-OUTDOOR-SENSOR	RF Battery-powered Outdoor Temperature Sensor
KRF-SIGNAL REPEATER	RF USB Powered Signal Extender (+30ft)

INSTALLATION TIPS - WALL LOCATIONS

The thermostat should be installed approximately 4 to 5 feet above the floor. Select an area with average temperature and good air circulation. Pick an installation location that is easy for the user to access. The temperature of the location should be representative of the building.

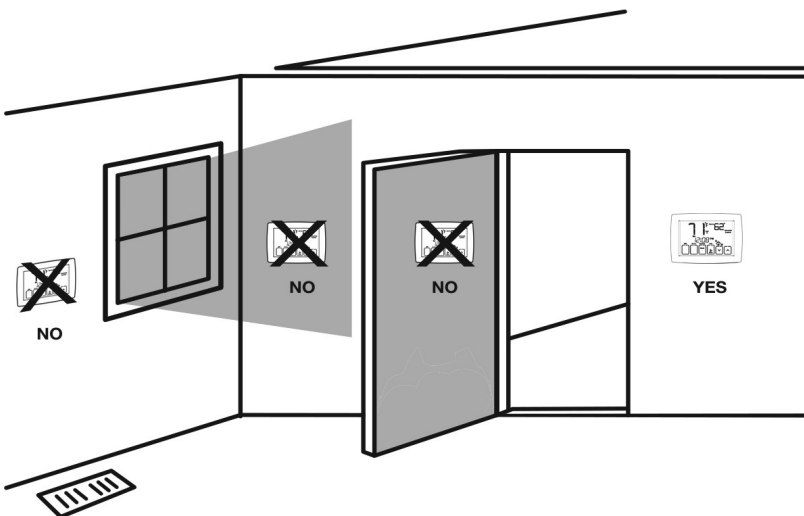

Do not install thermostat in these locations:

- Close to hot or cold air ducts
- That are in direct sunlight
- With an outside wall behind the thermostat
- In areas that do not require conditioning
- Where there are dead spots or drafts (in corners or behind doors)
- Where there might be concealed chimneys or pipes

KRFTP-B RF THERMOSTAT INSTALLATION



KRFTP-B: RF Thermostat

SPECIFICATIONS

Supply Voltage: 24V, 50-60Hz Rating: 0.5A

Wireless Operation: Rf Connect Button

Working Frequency: 915.055 MHz

Working Distance: 30 Meters

Heat Pump Control: (Heating and Cooling).

Touch Screen: Touch Sensitive

Temperature Display Range: 0°F to 95°F (-17°C to 35°C)

Temperature Control Range: 44°F to 90°F (07° C to 32°C)

Display Accuracy: ± 1°F

Optimal Start/Stop: Optimal Start ensures that the set temperature is reached at the scheduled time, while Optimal Stop shuts down the system early upon PROG transition to achieve energy savings.

Deadband: Adjustable 4 to 6 Degrees. (Default 5)

Differential: adjustable from 0.5°F to 2.0°F (Default 1°F)

2nd Stage Offset: adjustable from 2°F to 5°F (Default 3°F)

Boost Emergency Heat Stage (Electric) Time Variable: 5 minutes - 30 minutes range. (default 15 min)

Heat Schedule Options: 5+2 / 5+1+1/ 7 (Default: 5+2)

WARNINGS

1. Changes or modifications to this unit not expressly approved by the party responsible for compliance could void the user authority to operate the equipment.
2. To comply with FCC RF exposure compliance requirements, a separation distance of at least 20 cm must be maintained between the antenna of this device and all persons.
3. This Transmitter must not be co-located or operating in conjunction with any other antenna or transmitter.
4. This device complies with Part 15 of the FCC Rules. Operation is subject to the following two conditions: (1) this device may not cause harmful interference, and (2) must accept any interference received, including interference that may cause undesired operation.

MOUNTING INSTRUCTIONS

Attach Mounting Plate To Wall:

Horizontal Mount Only. Secure one screw on the left and one screw on the right side of the thermostat.

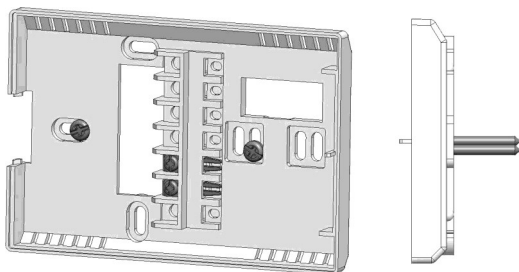

Attach Thermostat to Mounting Plate:

Align the 2 tabs on the thermostat face with corresponding slots on the mounting plate, then push gently until it snaps in place.

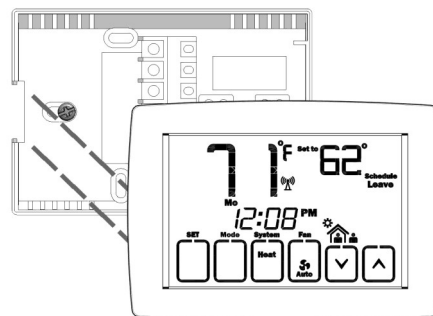

Note: To ensure a solid fit between the thermostat and the mounting plate:

1. Mount mounting plate to a flat wall.
2. Use screws provided.
3. Drywall anchors should be flush with the wall.
4. Wires should be pushed into the wall.

KRFTP-B RF WIRING INSTRUCTIONS

⚠ Caution:
Electrical Hazard

Failure to disconnect the power before beginning to install this product can cause electrical shock or equipment damage.

⚠ Warning:

All components of the control system and the thermostat installation must conform to Class II circuits per the NEC Code.

Caution: Turn off power at the circuit breaker before performing any work on the electrical connections. None of the electrical connections must be live until the installation has been completed and the housing is closed. Only a qualified electrician or authorized technician are permitted to open the terminal box.

Wiring requires a Phillips screwdriver

1. If you are replacing a thermostat, make note of the terminal connections on the thermostat that is being replaced. In some cases the wiring connections will not be color coded. For example, the green wire may not be connected to the G terminal.
2. Loosen the terminal block screws. Insert wires then retighten the terminal block screws.
3. Place nonflammable insulation into the wall opening to prevent drafts.

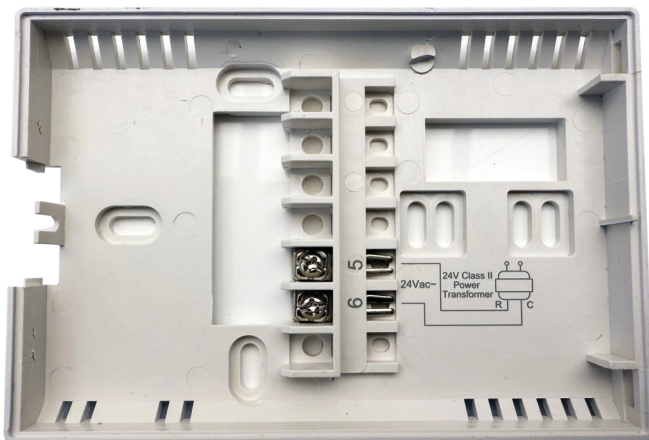

WIRING TIPS

C Terminal

The C (common wire) terminal does not have to be connected when the thermostat is powered by batteries.

Wire Specifications

Use shielded or non-shielded 18-22 gauge thermostat wire.

BATTERY INSTALLATION

Battery installation is optional. Battery Power can be used as primary or as emergency battery backup power for 24V power.

Important: High quality alkaline batteries are recommended. Rechargeable batteries or low quality batteries do not guarantee optimal lifespan.

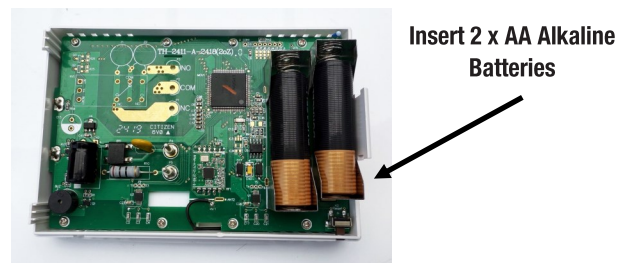

KRFR-24V HVAC RELAY INSTALLATION



KRFR-24V: 24V HVAC Relay

Specifications:

Power supply type: 24VAC

Rating: 24VAC/2A

Wireless Connect: Rf Connect Button

Two-way Communication

WIRING INSTRUCTIONS

Step 1: Remove Blue Covers Screws (4)

Step 2: Remove Blue Covers To

Step 3: Wire Terminals Per

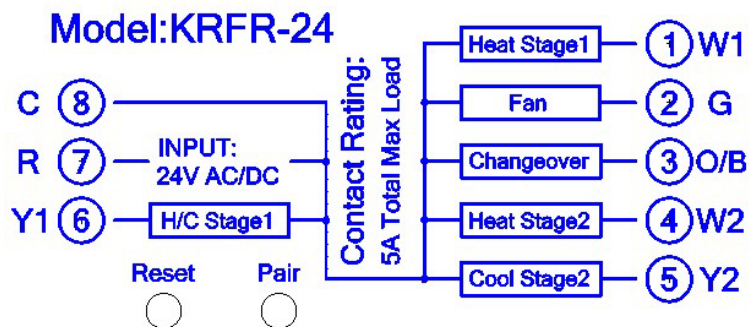
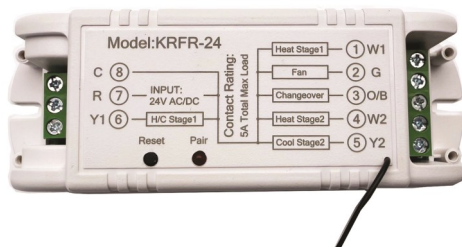
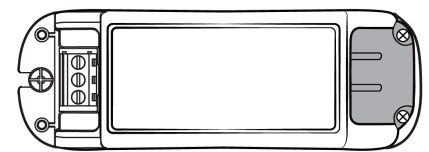
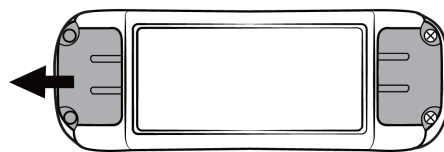
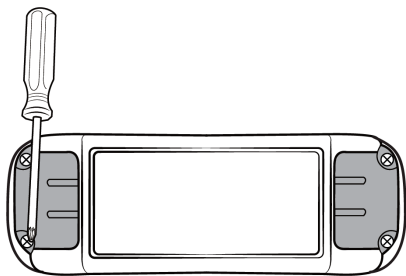

GENERAL NOTES

1. A single KRFTP-B Thermostat can be paired with multiple KRFR-24V relays, provided each relay is within range of the RF signal.
2. Each relay controls one or more 24V HVAC unit within its zone, without exceeding the relay's maximum amperage rating.
3. All paired KRFR-24V relays operate in sync - turning on and off simultaneously.

PAIRING INSTRUCTIONS

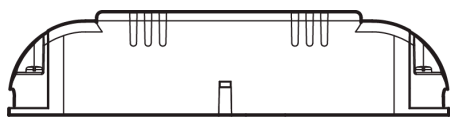

RF Pairing Button

- Step 1:** Press and hold the KRFR-24V Pairing Button for 5 seconds. The LED flashes when it is in pairing mode.
- Step 2:** Press and hold the MODE button on the KRFTP-B thermostat for 3 seconds to pair.
 - A. When KRFR-24V receives a signal, the LED will flash three times.
 - B. If not paired, the LED will remain on.
- Step 3:** Once pairing is successful, the KRFTP-B thermostat will display the device name + the device signal strength, e.g. "KRFLR66".

Note: "66" represents -66 dBm. A higher number indicates a weaker signal.
- Step 4:** Repeat steps 1 thru 3 to pair additional KRFR-24V relays to the system.

KRFR-24V RELAY MOUNTING TIPS

If the HVAC Unit is an attic installation, instead of placing the KRFR-24V Relay in the attic, locate the KRFR-24V relay in the closest closet within the living space to the HVAC unit and mount on the wall inside the closet or on the ceiling of the closet. This location will insure the relay is below the 150°F maximum ambient temperature specification.

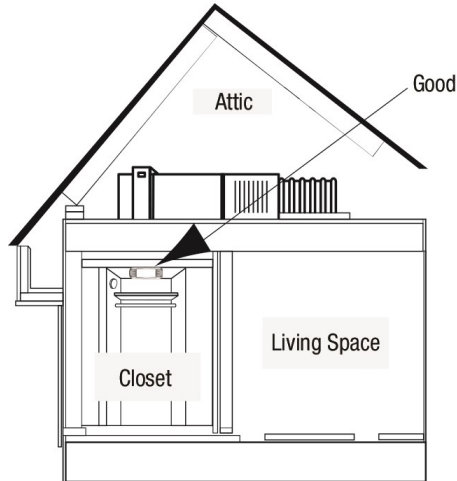

Do not install the KRFR-24V Relay in locations:

- That are behind a chimney
- Where temperature could exceed 150°F
- Where rain or snow or extreme hot or cold is possible

Note: This KRFR-24V Relay is NOT weatherproof.

KRFR-24V Relay Range

Range between the thermostat and the KRFR-24V Relay is up to 98.5 feet with no obstructions and approximately 50 feet in standard residential construction.

To extend the range try replacing the base unit higher if in a basement or further away from large metal objects.

Or add the optional #KRF-REPEATER, *which is an* RF Extender module to extend the range.

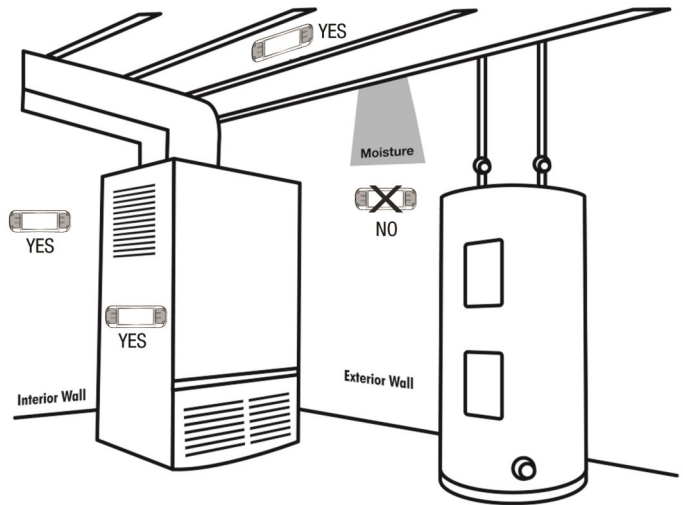

Follow these steps for a simple wireless communication setup.

1. **Locate all components in an area near the HVAC equipment.**
2. **Wire KRFR-24V relay with 8ft pigtail and temporarily mount.**

If you are not able to establish communication, this will allow you to relocate the module to an area with less obstruction, without having to rewire.

- A. Follow the pairing instructions in this manual
- B. Establish communication between devices

Install thermostat in final location.

Turn on fan from thermostat to ensure communication.

Once communication is established, permanently mount KRFR-24V Relay.

Troubleshooting:

If there is no communication between the thermostat and KRFR-24V Relay that are less than 50ft. apart, utilize an 8ft. pigtail to relocate and reduce interference. If there is not communication and devices are over 50ft. apart, add a KRF-REPEATER - Wireless Repeater.

TERMINAL DESCRIPTIONS BY SYSTEM TYPE

Conventional Systems

2-Stage Conventional System with Emergency Heat

Terminal	1 Heat 1 Cool Conventional System	1 Heat 2 Cool Conventional System	2 Heat 1 Cool Conventional System	2 Heat 2 Cool Conventional System
C	Transformer common	Transformer common	Transformer common	Transformer common
R	Transformer power (24V)	Transformer power (24V)	Transformer power (24V)	Transformer power (24V)
G	Fan relay	Fan relay	Fan relay	Fan relay
W1	First stage of heat	First stage of heat	First stage of heat	First stage of heat
W2/AUX	N/A	N/A	Second stage of heat / Auxiliary heat	Second stage of heat / Auxiliary heat
Y1	First stage of cool	First stage of cool	First stage of cool	First stage of cool
Y2	N/A	Second stage of cool	N/A	Second stage of cool
E	Emergency Heat	Emergency Heat	Emergency Heat	Emergency Heat

Heat Pump Systems

Terminal	1 Heat 1 Cool Heat Pump System	2 Heat 1 Cool Heat Pump System	2 Heat 2 Cool Heat Pump System	3 Heat 2 Cool Heat Pump System
C	Transformer common	Transformer common	Transformer common	Transformer common
R	Transformer power (24V)	Transformer power (24V)	Transformer power (24V)	Transformer power (24V)
G	Fan relay	Fan relay	Fan relay	Fan relay
O/B	Heat pump changeover valve energized in cooling	Heat pump changeover valve energized in cooling	Heat pump changeover valve energized in cooling	Heat pump changeover valve energized in cooling
W1	N/A	N/A	N/A	N/A
W2/AUX	N/A	Second stage of heat / Auxiliary heat	N/A	Third stage of heat / Auxiliary heat
Y1	First stage of cooling and heating	First stage of cooling and heating	First stage of cooling and heating	First stage of cooling and heating
Y2	N/A	N/A	Second stage of cooling and heating	Second stage of cooling and heating
E	Emergency Heat	Emergency Heat or Second Stage Heating	Emergency Heat	Emergency Heat or Third Stage Heating

QUICK OPERATION INSTRUCTIONS

PAIRING MODE: HVAC RELAY

- (1) Press and hold the KRFR-24V relay's pairing button for 5 seconds, and the LED flashes 2Hz to enter pairing mode
- (2) Press and hold **MODE** button on the KRFTP-B for 3 seconds to pair
- (3) After pairing, KRFTP-B displays **device name + signal strength**.

OVERRIDE

- (1) Press \triangle / ∇ to set Override Temperature
- (2) Press **OK** to confirm
- (3) Press **CANCEL** to release

FAN

- (1) Press **FAN** to switch FAN On/Auto Mode

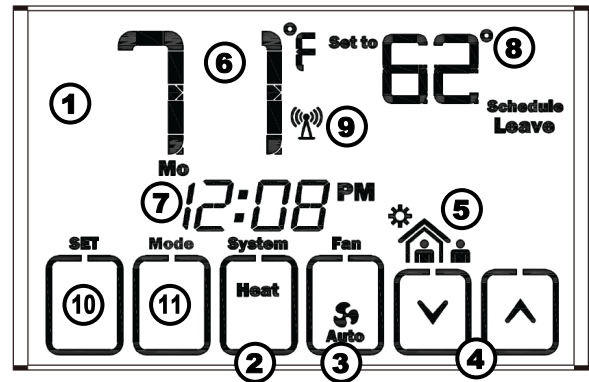

SYSTEM

- (1) Press **System** button to switch Heat / OFF / Auto / Cool / Em Ht

HOLD/VACATION

- (1) Press **MODE** two times to enter the HOLD / HOLIDAY setting mode
- (2) Press \triangle / ∇ to adjust the settings
- (3) Press **OK** to confirm

1. Touch Screen LCD Display
2. System Mode Button
3. Fan Mode Button
4. Up & Down Buttons
5. Period Icons
6. Current Room Temperature
7. Current Day & Time
8. Temperature Setpoint
9. RF Signal Connection Icon
10. Set/Program Menu Options Button
11. Mode Button / OK / HOLD

KEYPAD LOCK

- (1) Press and hold **SET** button and then quickly press the \triangle button for 3 seconds to switch Key Lock On/OFF.

UNPAIR HEAT PUMP / ELECTRIC HEAT RELAYS

- (1) Press and hold the pair button of the wireless devices for 10 seconds to unpair.

SHOW OUTDOOR TEMPERATURE (with Optional Outdoor Sensor in System)

- (1) Press and hold **SET** button and then quickly press the ∇ button to show outdoor temperature.

USER-DEFINED SETTINGS ON THERMOSTAT

USER MENU

Step 1: Press **SET** to enter the User Settings Menu to set user-defined parameters.

Step 2: Press Δ / ∇ to adjust the settings

Step 3: When multiple parameters are required for a Setting **OK** appears. Press **OK** go to next parameter.

Step 4: Press **SET** to confirm and proceed to next Setting.

Step 5: Press and hold **SET** for 3 sec to exit setting mode.

UserMenu Setup Steps		LCD Will Show	Adjustment Options	Default
Clock	Set Current Day	Set Mo (flashing)	Set Day of Week Mo / Tu / We / Th / Fr / Sa / Su	Mo
-Press OK Clock step 2	Press OK: Set Current Time	Set 12:00 (flashing)	Set Current Time Set Hour Press OK to Set Minutes	12:00
Prog	Program Day of Heating Schedule	Set Mo DAY (flashing)	Set Day of Week To Program Schedule Mo / Tu / We / Th / Fr / Sa / Su	Mo
-Press OK Prog step 2	Press OK: Program Time For Each Period of Heating Schedule	Set 6:00 (flashing)	Set Time Set Hour Press OK to Set Minutes	6:00
-Press OK Prog step 3	Press OK: Program Temp For WAKE Period of Heating Schedule	Set 78°F WAKE (flashing)	Choose Set Temp for Wake Period Range of 44°F to 90°F Press OK to move to next Period	78°F
-Press OK Prog step 4	Press OK: Program Temp For LEAVE Period of Heating Schedule	Set 85°F LEAVE (flashing)	Choose Set Temp for Return Period Range of 44°F to 90°F Press OK to move to next Period	85°F
-Press OK Prog step 5	Press OK: Program Temp For RETURN Period of Heating Schedule	Set 78°F RETURN (flashing)	Choose Set Temp for Sleep Period Range of 44°F to 90°F Press OK to move to next Period	78°F
-Press OK Prog step 6	Press OK: Program Temp For SLEEP Period of Heating Schedule	Set 82°F Leave SLEEP (flashing)	Choose Set Temp for Leave Period Range of 44°F to 90°F Press OK to move to next Period	82°F

User Menu Setup Steps CONTINUED		LCD Will Show	Adjustment Options	Default
Display Temp Offset	Changes the calibration of room temp display. E.g. Display reads 70° and you want it to read 72° then select +2.	Set OFFSET	Select from range of -5°F to 5°F	0°F
Differential	Temperature range between the stat switch-on and switch-off points	Set DIFF	Select from range of 1°F to 2°F	1°F
Contrast	Set the display contrast	Set CONT:7	Select from range of 1 (dimmest) to 7 (brightest)	7
C/F	Display temperatures in either Fahren- heit or Celsius	Set SCALE	Select °F or °C	°F
Beep	When ON an audible beep will sound	Set BEEP:OF	Select OF for Off Select ON for On	OF
Filter Service Time	Filter Service Reminder Time.	Filter Service Set OFF	Select between: Off - 100 - 9000 hours	OFF

NOTE: Compressor Delay Times For Heat Pump Systems

Type	System	Delay
1H1C	Heat pump	3 min
2H1C	Heat pump	3 min
2H2C	Heat pump	3 min
3H2C	Heat pump	3 min

INSTALLER/ TECHNICIAN SETUP MENU

This thermostat has a technician setup menu for easy installer configuration. To set up the thermostat for your particular application:

- (1) Press and hold **SET** for 5 seconds to enter the Technician Setup Options Menu.
- (2) Enter Pin code (ID) and Press **OK**. **TIP:** Use \triangle to change digit. Use ∇ to switch to next digit.
- (3) Press \triangle / ∇ to adjust the settings.
- (4) Press **OK** to confirm and proceed to next Setting.
- (5) Press **CONT** to exit setting mode .

HOW TO FIND PIN CODE (ID)?

1. Turns System OFF
2. Touch bottom LEFT + bottom RIGHT corner of the display. The Pin Code will appear on the display.

Installer Menu Setup Steps	LCD Will Show	Adjustment Options	Default
System Mode / Stages	T This feature is required to set the system type being used with desired stages.	Set 1H1C-HP Choose between: 1H1C (heat pump) 2H1C (heat pump) - HEAT2: W2 / EH 2H2C (heat pump) 3H2C (heat pump) - HEAT3: W2 / EH 1H1C (conventional) 1H2C (conventional) 2H1C (conventional) 2H2C (conventional) 1H0C	1H1C-HP
2H1C Only 2nd Stage Heat: Heat Pump or Electric Heat	Option to set 2nd stage of heat to be 24V Controlled Heat Pump or 120/240V Electric Heat	Set HEAT2: W2	Select between: W2 (24V Heat) EH (Electric Heat) W2
3H2C Only 3rd Stage Heat: Heat Pump or Electric Heat	Option to set 3rd stage of heat to be 24V Controlled Heat Pump or 120/240V Electric Heat	Set HEAT3: W2	Select between: W2 (24V Heat) EH (Electric Heat) W2
Heating Schedule Options	You can configure this thermostat to have a 7 day program, a 5+1+1 program or 5+2 program	Set PROG: 7D	Select 7D for 7 day schedule or select 52 for 5-2 / 5 day + weekend or select 51 for 5-1-1 / 5 day + Sat + Sun 7D
Manual Emergency Heat Mode	Enable or Disable Manual Emergency Heat Option	Set EM HT: Y	Select Y for Enabled Select N for Disabled Y
Auto Change - Over	This thermostat can automatically switch between Heat and Cool Modes	Set AUTO: N	Select Y for Enabled Select N for Disabled N
2nd Stage Offset	Adjustable from 2°F to 5°F	Set 3°F STAGE 2	Select between Range: 2°F to 5°F 3°F

Installer Menu Setup Steps	LCD Will Show	Adjustment Options	Default
3H2C Only 3rd Stage Offset	Adjustable From Stage2 Offset + 1°F to 3°F (3H2C-HP only)	Set 3°F STAGE 3	Select between Range: Stage2 Offset + 1°F 2°F 3°F 3°F
Optimal Start	Ensures set temperature is reached at the scheduled time	Set START: OF	Select OF for Off Select ON for On OF
Optimal Stop	Turns system off early upon PROG transition to achieve energy savings	Set STOP: OF	Select Y for Enabled Select N for Disabled OF
Heating Temp Setpoint Limit	Set a maximum heating setpoint limit. The setpoint temperature cannot be raised above this value.	Set 90°F LIMIT: H	Select from range of 44°F to 90°F 90°F
Cooling Temp Setpoint Limit	Set a minimum cooling setpoint limit. The setpoint temperature cannot be lowered below this value.	Set 44°F LIMIT: C	Select from range of 44°F to 90°F 44°F
PIR Occupancy Sensor	Activates PIR Occupancy Sensor Features if being Used in System	Set PIR: N	Select Y for Enabled Select N for Disabled N
RF PIR Occupancy Sensor Time Delay (PIR: Y)	Sets the Setback Temperature Time Delay	Set DELAY	Select between: 10 minutes 30 minutes 60 minutes 10

INSTALLER/ TECHNICIAN SETUP MENU - Continued

Installer Menu Setup Steps CONTINUED		LCD Will Show	Adjustment Options	Default
RF Window/Door Sensor Being Used In System	Activates RF Window/Door Sensor Being Used In System	Set WIN: N	Select Y for Enabled Select N for Disabled	N
RF Master Setback Switch Being Used In System	Activates RF Master Setback Switch Being Used In System	Set MASTER: N	Select Y for Enabled Select N for Disabled	N
Heating Setback Temp (PIR/WIN / MASTER SWITCH)	Sets the Heating Setback Temperature (PIR / WIN / MASTER SWITCH)	65°F SETBACK	Select from range of 44°F to 65°F	65°F
Cooling Setback Temp. (PIR/WIN / MASTER SWITCH)	Sets the Cooling Setback Temperature (PIR / WIN / MASTER SWITCH)	80°F SETBACK	Select from range of 80°F to 90°F	80°F
Outdoor Temperature Sensor Being Used in System	Outdoor Sensor will be used for Boost Emergency Heat Activation instead of time variable when enabled.	ODSEN:N	Select Y for Enabled Select N for Disabled	N
Boost Emergency Heat Stage Time Variable (ELEC2:N)	Emergency Electric Heat will turn on if set point is not reached within (time)	15 TIME: EH	Select from range of 5 minutes to 30 minutes	15
LCD Backlight	Backlight always on – “C” wire required	LIGHT: N	Select Y for Enabled Select N for Disabled	N
Freeze Protection Mode	Heat will turn on if room temp drops below 40F	FROST: Y	Select Y for Enabled Select N for Disabled	Y

***IMPORTANT: SELECT N = Disabled** when operating on battery power only to conserve battery life.

SETTING DATE & TIME

Follow the steps below to set the day of the week and current time:

1. Press the **SET** button to access setup menu. The first setting is to **Set the Day of the Week**.
2. Day of the week is flashing. Use the \triangle or ∇ key to select the current day of the week.
3. Press **OK** to move to next step.
4. The current hour is flashing. Use the \triangle or ∇ key to select the current hour. When using 12-hour time, make sure the correct a.m. or p.m. choice is selected.
5. Press **OK** to move to next step.
6. Minutes are now flashing. Use the \triangle or ∇ key to select current minutes.
7. Press and hold **SET** button for 3 sec to save settings and exit setting mode.

ABOUT YOUR HEATING SCHEDULE

Your thermostat can be programmed to have each day of the week programmed uniquely (7 days), all the weekdays the same with a separate program for Saturday and Sunday (5+2), or all the weekdays the same with a separate program for Saturday and a separate program for Sunday (5+1+1). For all options, there are 4 time period per day. (**WAKE, LEAVE, RETURN, SLEEP**)





PROGRAM CUSTOM 7-DAY HEATING SCHEDULE

Follow the steps below to set the time and temperature for each period of the day:

1. Press the **SET** button to access setup menu. The first setting is to **Set the Clock (see above)**.
2. Press the **SET** button again to start **Programing The Heating Schedule (Day of the Week, Temperature Setpoint and Period Start Time)** for each period of the day. (**WAKE, LEAVE, RETURN, SLEEP**)
3. Day of the week is flashing. Use the \triangle or ∇ key to select the day of the week to be programmed.
4. Press **OK** to move to next step.
5. The Time is now flashing. Use the \triangle or ∇ key to select the Hour/Minutes for the period Start Time.
6. Press **OK** to move to next step.
7. The Temperature is now flashing. Use the \triangle or ∇ key to select desired Temperature Setpoint for the period.
8. Press **OK** to move to next step to program the next period.
9. Repeat the above steps for each Period of the Day.

Repeat steps 3 through 7 for the remaining days of the week.

Press and hold **SET** button for 3 sec to save settings and exit setting mode.

Residential 7-Day Programming							
MON/TUE/WED/THU/FRI/SAT/SUN Default Schedule							
4 Event	Monday	Tuesday	Wednesday	Thursday	Friday	Saturday	Sunday
Wake 	Time: 6:00 am Heat: 70°F (21°C) Cool: 78°F (26°C)	Time: 6:00 am Heat: 70°F (21°C) Cool: 78°F (26°C)	Time: 6:00 am Heat: 70°F (21°C) Cool: 78°F (26°C)	Time: 6:00 am Heat: 70°F (21°C) Cool: 78°F (26°C)	Time: 6:00 am Heat: 70°F (21°C) Cool: 78°F (26°C)	Time: 6:00 am Heat: 70°F (21°C) Cool: 78°F (26°C)	Time: 6:00 am Heat: 70°F (21°C) Cool: 78°F (26°C)
Leave 	Time: 8:00 am Heat: 62°F (17°C) Cool: 85°F (29°C)	Time: 8:00 am Heat: 62°F (17°C) Cool: 85°F (29°C)	Time: 8:00 am Heat: 62°F (17°C) Cool: 85°F (29°C)	Time: 8:00 am Heat: 62°F (17°C) Cool: 85°F (29°C)	Time: 8:00 am Heat: 62°F (17°C) Cool: 85°F (29°C)	Time: 8:00 am Heat: 70°F (17°C) Cool: 78°F (29°C)	Time: 8:00 am Heat: 70°F (17°C) Cool: 78°F (29°C)
Return 	Time: 6:00 pm Heat: 70°F (21°C) Cool: 78°F (26°C)	Time: 6:00 pm Heat: 70°F (21°C) Cool: 78°F (26°C)	Time: 6:00 pm Heat: 70°F (21°C) Cool: 78°F (26°C)	Time: 6:00 pm Heat: 70°F (21°C) Cool: 78°F (26°C)	Time: 6:00 pm Heat: 70°F (21°C) Cool: 78°F (26°C)	Time: 6:00 pm Heat: 70°F (21°C) Cool: 78°F (26°C)	Time: 6:00 pm Heat: 70°F (21°C) Cool: 78°F (26°C)
Sleep 	Time: 10:00 pm Heat: 62°F (17°C) Cool: 82°F (28°C)	Time: 10:00 pm Heat: 62°F (17°C) Cool: 82°F (28°C)	Time: 10:00 pm Heat: 62°F (17°C) Cool: 82°F (28°C)	Time: 10:00 pm Heat: 62°F (17°C) Cool: 82°F (28°C)	Time: 10:00 pm Heat: 62°F (17°C) Cool: 82°F (28°C)	Time: 10:00 pm Heat: 62°F (17°C) Cool: 82°F (28°C)	Time: 10:00 pm Heat: 62°F (17°C) Cool: 82°F (28°C)

PROGRAMMING CUSTOM 5-2 HEATING SCHEDULE

Follow the steps below to set the time and temperature for each period of the day:

1. Press the **SET** button to access setup menu. The first setting is to **Set the Clock (see above)**.
2. Press the **SET** button again to start **Programing The Heating Schedule (Day of the Week, Temperature Setpoint and Period Start Time)** for each period of the day. (**WAKE, LEAVE, RETURN, SLEEP**)
3. The Week Days (MoTuWeThFri) are flashing. Continue to next step or use the Δ or ∇ key to select the Weekend Days (SaSun) to be programmed.
4. Press **OK** to move to next step.
5. The Time is now flashing. Use the Δ or ∇ key to select the Hour/Minutes for the period Start Time.
6. Press **OK** to move to next step.
7. The Temperature is now flashing. Use the Δ or ∇ key to select desired Temperature Setpoint for the period.
8. Press **OK** to move to next step to program the next period.
9. Repeat the above steps for each Period of the Day.

Repeat steps 3 through 7 for the remaining Weekend Days (SatSun).

Press and hold **SET** button for 3 sec to save settings and exit.





PROGRAMMING CUSTOM 5-1-1 HEATING SCHEDULE





Follow the steps below to set the time and temperature for each period of the day:

1. Press the **SET** button to access setup menu. The first setting is to **Set the Clock (see above)**.
2. Press the **SET** button again to start **Programing The Heating Schedule (Day of the Week, Temperature Setpoint and Period Start Time)** for each period of the day. (**WAKE, LEAVE, RETURN, SLEEP**)
3. The Week Days (MoTuWeThFri) are flashing. Continue to next step or use the Δ or ∇ key to select the Saturday or Sunday to be programmed.
4. Press **OK** to move to next step.
5. The Time is now flashing. Use the Δ or ∇ key to select the Hour/Minutes for the period Start Time.
6. Press **OK** to move to next step.
7. The Temperature is now flashing. Use the Δ or ∇ key to select desired Temperature Setpoint for the period.
8. Press **OK** to move to next step to program the next period.
9. Repeat the above steps for each Period of the Day.

Repeat steps 3 through 7 for Saturday and Sunday

Press and hold **SET** button for 3 sec to save settings and exit.

Residential 5-2 Day Programming Weekday/Weekend Default Schedule		
4 Event	Weekday	Weekend
Wake 	Time: 6:00 am Heat: 70°F (21°C) Cool: 78°F (26°C)	Time: 6:00 am Heat: 70°F (21°C) Cool: 78°F (26°C)
Leave 	Time: 8:00 am Heat: 62°F (17°C) Cool: 85°F (29°C)	Time: 8:00 am Heat: 70°F (17°C) Cool: 78°F (29°C)
Return 	Time: 6:00 pm Heat: 70°F (21°C) Cool: 78°F (26°C)	Time: 6:00 pm Heat: 70°F (21°C) Cool: 78°F (26°C)
Sleep 	Time: 10:00 pm Heat: 62°F (17°C) Cool: 82°F (28°C)	Time: 10:00 pm Heat: 62°F (17°C) Cool: 82°F (28°C)

Residential 5-1-1 Day Programming Weekday/SAT/SUN Default Schedule			
4 Event	Weekday	Saturday	Sunday
Wake 	Time: 6:00 am Heat: 70°F (21°C) Cool: 78°F (26°C)	Time: 6:00 am Heat: 70°F (21°C) Cool: 78°F (26°C)	Time: 6:00 am Heat: 70°F (21°C) Cool: 78°F (26°C)
Leave 	Time: 8:00 am Heat: 62°F (17°C) Cool: 85°F (29°C)	Time: 8:00 am Heat: 70°F (17°C) Cool: 78°F (29°C)	Time: 8:00 am Heat: 70°F (17°C) Cool: 78°F (29°C)
Return 	Time: 6:00 pm Heat: 70°F (21°C) Cool: 78°F (26°C)	Time: 6:00 pm Heat: 70°F (21°C) Cool: 78°F (26°C)	Time: 6:00 pm Heat: 70°F (21°C) Cool: 78°F (26°C)
Sleep 	Time: 10:00 pm Heat: 62°F (17°C) Cool: 82°F (28°C)	Time: 10:00 pm Heat: 62°F (17°C) Cool: 82°F (28°C)	Time: 10:00 pm Heat: 62°F (17°C) Cool: 82°F (28°C)

FILTER CHANGE REMINDER

If your installing contractor has configured the thermostat to remind you when the air filter needs changed, you will see a reminder in the display when your air filter needs changed. The reminder will be shown in the display after your system has run long enough to require an air filter change.

Resetting the filter change reminder: When the reminder is

displayed, you should change your air filter and reset the reminder by holding down the “**Clean**” key on the left side of the thermostat for 3 seconds.

TEMPORARY AND PERMANENT HOLD FEATURES

Temporary Hold: When you adjust the set temperature, the thermostat will display **Override** next to the setpoint temperature on the display. This is a temporary hold. If you do nothing, the temperature will remain at this setpoint temporarily for 4 hours. The program setpoint will then replace the temporary setpoint.

Permanent Hold: Press the **MODE** button to access the HOLD menu. Set the desired HOLD temperature and press **OK**. You will see **HOLD** appear next to the setpoint temperature in the display. The thermostat will now permanently stay at this setpoint until manually cancelled.

To Return To Programmed Schedule Press the **CANCEL** button at the bottom of the screen to exit temporary and permanent holds.