

Features

- 1/2" (12.7 mm) angle supply with stop
- Four-arm handle

Material

- KOHLER finishes resist corrosion and tarnishing
- Solid-brass construction for durability and reliability



Codes/Standards











ASME A112.18.1/CSA B125.1

KOHLER® Faucet Lifetime Limited Warranty

See website for detailed warranty information.

Available Colors/Finishes

Color tiles intended for reference only.

| Color | Code | Description |
|---|------|--------------------------------|
|  | CP | Polished Chrome |
|  | SN | Vibrant® Polished Nickel |
|  | AF | Vibrant® French Gold |
|  | BN | Vibrant® Brushed Nickel |
|  | BV | Vibrant® Brushed Bronze |
|  | BL | Matte Black |
|  | 2MB | Vibrant® Brushed Moderne Brass |
|  | BGP | Vibrant Brushed Graphite |
|  | TT | Vibrant Titanium |
|  | DR | Deep Bronze |

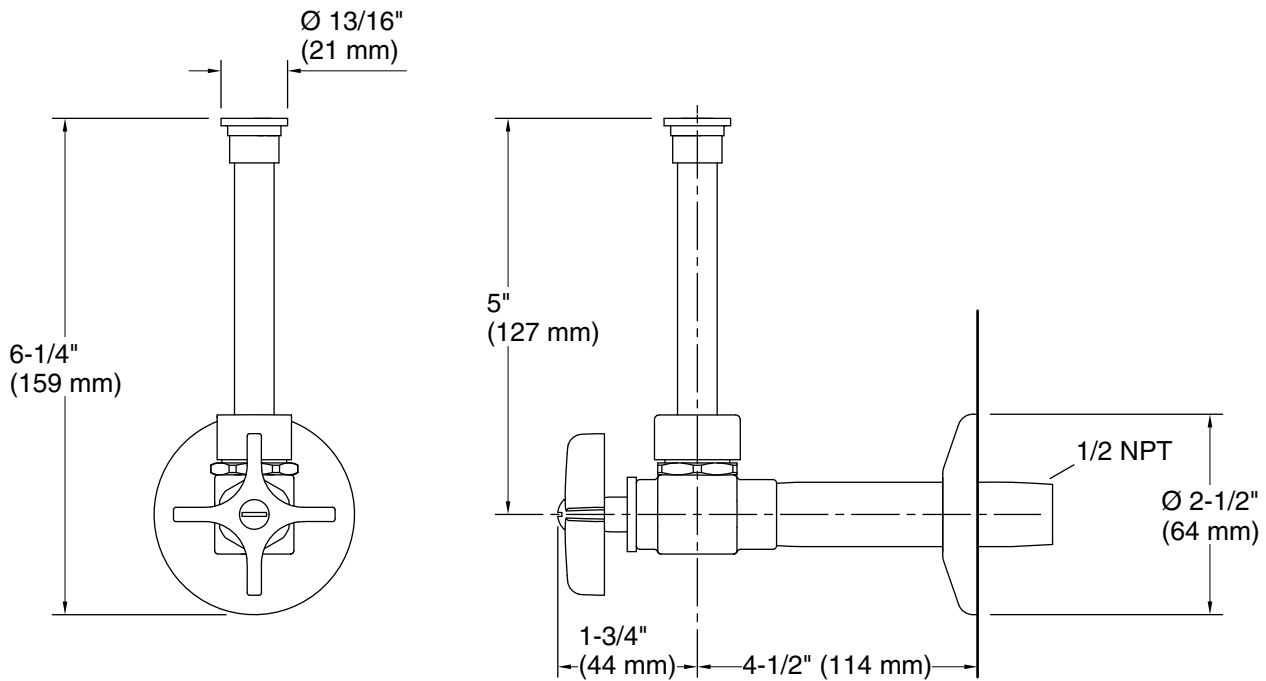

Technical Information

All product dimensions are nominal.

Material: Brass

Notes

Install this product according to the installation instructions.