

Features

- Compression valve
- Annealed vertical tube with supply flange
- 3/8 NPT connection with flange
- Four-arm handle stop

Material

- Brass

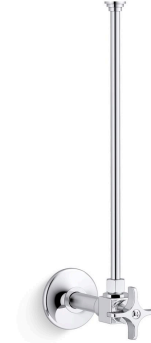

Codes/Standards











ASME A112.18.1/CSA B125.1

KOHLER® One-Year Limited Warranty

See website for detailed warranty information.

Available Colors/Finishes

Color tiles intended for reference only.

Color	Code	Description
	CP	Polished Chrome
	SN	Vibrant® Polished Nickel
	AF	Vibrant® French Gold
	BN	Vibrant® Brushed Nickel
	BV	Vibrant® Brushed Bronze
	BL	Matte Black
	2MB	Vibrant® Brushed Moderne Brass
	BGP	Vibrant Brushed Graphite
	TT	Vibrant Titanium
	DR	Deep Bronze

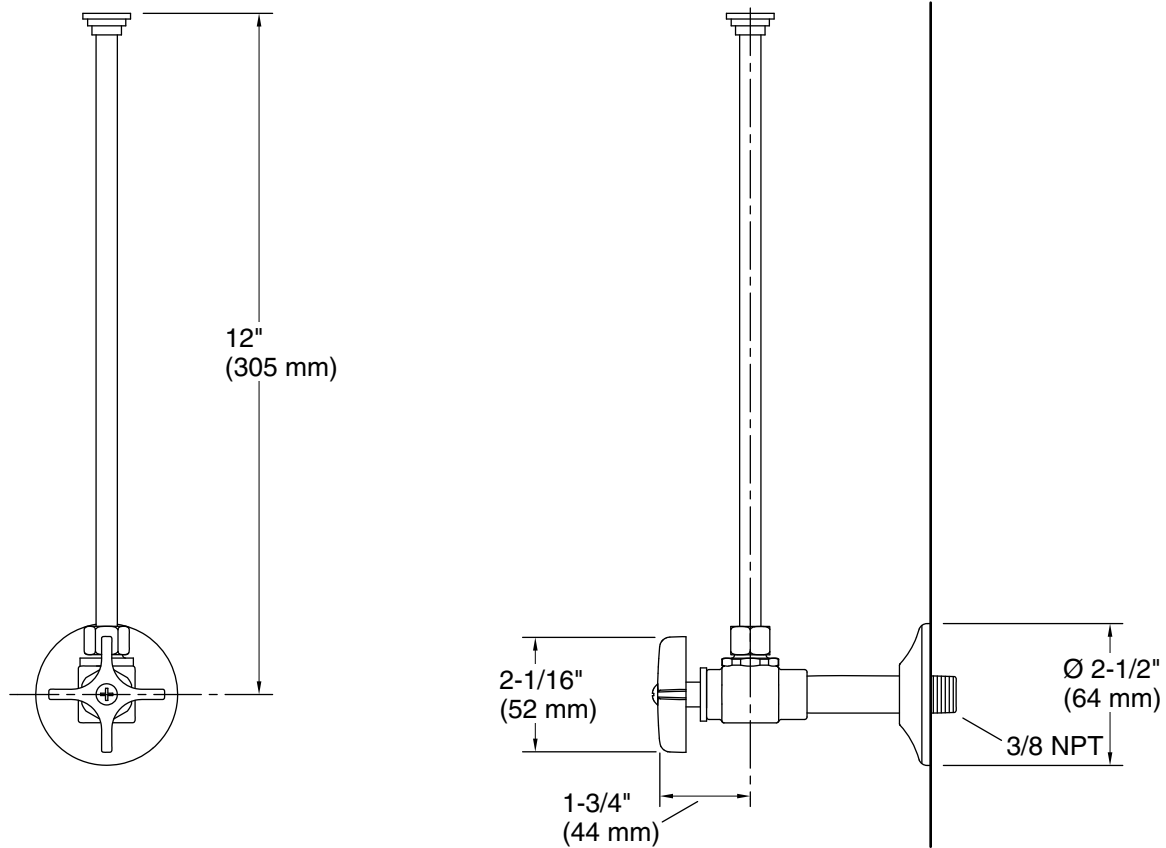

Technical Information

All product dimensions are nominal.

Material: Brass

Notes

Install this product according to the installation instructions.