

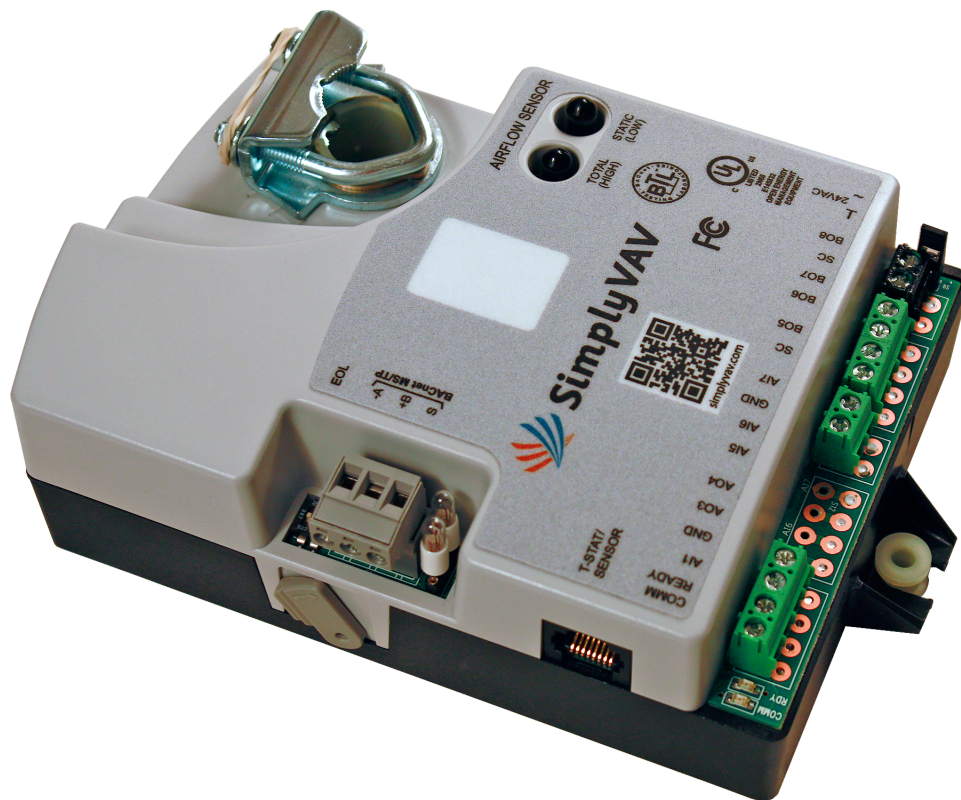

SimplyVAV

Application and Installation Guide



©2018, KMC Controls, Inc.

NetSensor, WinControl, and the KMC logo are registered trademarks of KMC Controls, Inc.

AppStat, BACstage, FlexStat, FullBAC, KMC Connect, KMC Connect Lite, KMC Converge, KMC Converge GFX, KMC Conquest, TotalControl, SimplyVAV, and the SimplyVAV logo are trademarks of KMC Controls, Inc.

All rights reserved. No part of this publication may be reproduced, transmitted, transcribed, stored in a retrieval system, or translated into any language in any form by any means without the written permission of KMC Controls, Inc.

Printed in U.S.A.

The material in this manual is for information purposes only. The contents and the product it describes are subject to change without notice. KMC Controls, Inc. makes no representations or warranties with respect to this manual. In no event shall KMC Controls, Inc. be liable for any damages, direct or incidental, arising out of or related to the use of this manual.

KMC Controls, Inc.

19476 Industrial Drive

New Paris, IN 46553

U.S.A.

TEL: 1.574.831.5250

FAX: 1.574.831.5252

info@kmccontrols.com

Contents	3
Section 1: About the controllers	5
Specifications	6
Accessories and replacement parts	9
Available models	10
Safety considerations	10
Section 2: Installing the controllers	13
Setting the rotation limits	13
Mounting on a VAV terminal box	14
Connecting an airflow sensor	15
Connecting inputs and outputs	15
Connecting room temperature sensors	15
Connecting a DAT sensor	16
Connecting power	17
Maintenance	18
Section 3: Changing the room setpoint	19
Section 4: Configuring the controllers	21
Getting started with configuration	21
Entering system temperature setpoints and limits	23
Configuring the VAV Box options	27
Set the airflow setpoints	29
Advanced options	33
Restore Application	35
Section 5: Balancing airflow	37
Section 6: Application drawings	41
Cooling or heating without reheat	42
Staged reheat	43
Modulating reheat	44
Time proportional reheat	45
Floating reheat	46
Dual-duct application	47
Section 7: Sequences of operation	49
Input sources	49
Occupancy sequence	50
Automatic occupancy	50
Occupied	50
Unoccupied	51
Standby	51
Space setpoints	51
Types of setpoints	51
Setpoint limits	52
PID control loops	52
Airflow setpoints sequence	53
Changeover	53
Discharge Air Temperature (DAT) limiting	53

System diagnostic indicators	54
NEED AHU (BV1)	55
NEED COLDER SUPPLY (BV2)	55
NEED MORE STATIC (BV3)	55
NEED HOTTER SUPPLY (BV7)	55
Damper operation	55
Fan operation	56
Series Fan	56
Parallel Fan	56
Reheat sequence	57
Modulating reheat	58
Staged reheat	58
Time proportioned reheat	59
Floating reheat	59
Balancing airflow sequence	60
Dual duct	61
Section 8: System integration and networking	63
Connecting to an MS/TP network	63
Connections and wiring	64
End of line termination switches	64
Network bulbs	64
Setting up network communications	65
BACnet objects	67
Input objects	67
Output objects	67
Value objects	68
Loop objects	70
Appendix A: K-factors	71
Index	73

Section 1: About the controllers

This section provides a description of the SimplyVAV series of controllers. It also introduces safety information. Review this material before selecting, installing, or operating the controllers.

The SimplyVAV series of controllers are an easy and unique approach to operating a wide variety of VAV terminal units. The integrated actuators, internal airflow sensors, and wide variety of application programs make these BACnet Application Specific controllers ideal for either new or retrofit installations.

The controllers feature simple, menu driven setup choices when used with a SimplyVAV digital sensor. No special programming skills or software tools are required to choose applications, enter setpoints, set network addressing, and balance airflow. All options can be set by using only an STE-8001 sensor which can be installed as the permanent room sensor or temporarily connected as a technician's service tool.

All models are BACnet Application Specific Controllers that are ready to connect to a BACnet MS/TP network. Device instance, MAC address, and baud rate are set from an STE-8001 sensor without special software.

BAC-8001 Model BAC-8001 is supplied with inputs, outputs, and sequences of operation for the following functions.

- Single duct heating and cooling VAV
- Automatic heating/cooling changeover including morning warmup
- Occupancy setback—requires STE-8201
- System diagnostic indicators
- Airflow balancing

BAC-8005 and BAC-8205 Models BAC-8005 and BAC-8205 are supplied with inputs, outputs, and sequences of operation for the following functions.

- Single duct heating and cooling VAV
- Modulating, floating, time proportional, and staged reheat
- Series and parallel fan control
- Automatic heating/cooling changeover including morning warmup
- Discharge air temperature limiting
- Occupancy setback—requires STE-8201
- Actuator position feedback for true damper positioning (BAC-8205 only)
- System diagnostic indicators
- Airflow balancing

BAC-8007 Model BAC-8007 is supplied with inputs, outputs, and sequences of operation for the following functions.

- Dual-duct VAV heating and cooling
- Occupancy setback—requires STE-8201
- System diagnostic indicators
- Airflow balancing

Additional topics in this section

Specifications	6
Accessories and replacement parts	9
Available models	10
Safety considerations	10

Specifications

SimplyVAV controller specifications are subject to change without notice.

Inputs and outputs

All inputs and outputs are factory programmed and application specific. No field configuration is required. For details on input and output connections, see the topic [Application drawings on page 41](#). For a detailed listing of input and output objects, see the topic [BACnet objects on page 67](#).

Analog inputs

Analog inputs represent BACnet analog input. Not all inputs are applicable or required for all models.

Key features	Standard units of measure. Overvoltage input protection
Connectors	RJ-45 room sensor jack Screw terminals for wire sizes 12-26 AWG
Conversion	12-bit analog-to-digital conversion
Input range	Passive, 10 k Ω pull-up to 3.3 volts DC

Analog outputs

Analog outputs are configured to represent BACnet analog output objects. No field configuration is required. For details on application specific output connections see the section [Application drawings on page 41](#).

Key features	Output short protection Standard units of measure
Connector	Screw terminals for wire size 12-26 AWG
Conversion	12-bit digital-to-analog conversion
Output voltage	0–10 VDC
Output current	30 mA per output, 30 mA total for all analog outputs

Binary outputs

Binary outputs are configured to represent BACnet binary output objects. No field configuration is required. For details on application specific output connections see the section [Application drawings on page 41](#).

Key features	Optically isolated triac output
Connector	Screw terminals for wire size 12-26 AWG
Output range	Maximum switching 24 Volts AC 1 ampere per external output, 3 amperes total

Communications—BACnet MS/TP

- EIA-485 operating at rates up to 76.8 kilobaud.
- Removable screw terminal block.
- Wire size 12-26 AWG
- Switch selected end of line termination

Memory

- Programs and program parameters are stored in nonvolatile memory.
- Auto restart on power failure

Air flow sensor features

- Configured as BACnet analog input object.
- CMOS differential pressure 0-2 inches of water (0-500 Pa) measurement range. Internally linearized and temperature compensated.
- Span accuracy 4.5% of reading.
- Zero point accuracy 0.0008 in. H₂O/0.2 Pa at 25° C
- Barbed connections for 1/4 inch FR tubing.

Actuator specifications

Torque	40 in-lb. (4.5 N•m)
Angular rotation	0 to 95° Adjustable end stops at 45° and 60° rotation
Motor timing BAC-8001, BAC-8005, BAC-8007	90 sec./90° at 60 Hz 108 sec./90° at 50 Hz
Motor timing BAC-8205	60 sec./90° at 60 Hz
Shaft size	Directly mounts on 3/8 to 5/8 inch (9.5 to 16 mm) round or 3/8 to 7/16 inch (9.5 to 11 mm) square damper shafts.

Regulatory

- UL 916 Energy Management Equipment
- BACnet Testing Laboratory listed as an application specific controller (ASC).
- CE compliant
- FCC Class B, Part 15, Subpart B and complies with Canadian ICES-003 Class B

This device complies with part 15 of the FCC Rules. Operation is subject to the following two conditions: (1) This device may not cause harmful interference, and (2) this device must accept any interference received, including interference that may cause undesired operation.

Installation

Supply voltage	24 volts AC, -15%, +20% 5 VA, 50/60 Hz
Weight	13.2 ounces (376 grams)
Case material	Flame retardant plastic

Environmental limits

Operating	32 to 120° F (0 to 49° C)
Shipping	-40 to 140° F (-40 to 60° C)
Humidity	5-93% relative humidity (non-condensing)

Dimensions

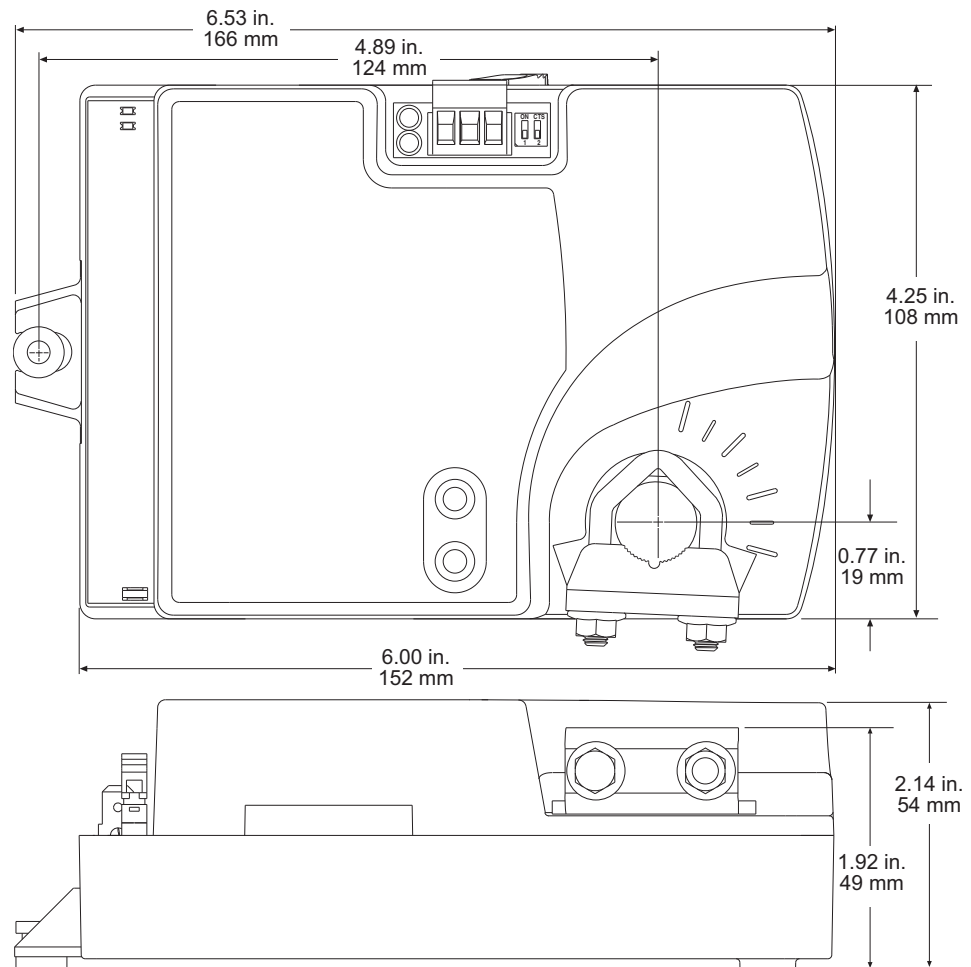

Accessories and replacement parts

The following accessories and replacement parts are available from KMC Controls, Inc.

Power transformer

XEE-6111-50	Transformer, 120-to-24 VAC, 50 VA, single-hub
XEE-6112-50	Transformer, 120-to-24 VAC, 50 VA, dual-hub
XEE-6311-100	Transformer, 120, 277 -to-24 VAC, 50/60 Hz, 96 VA, dual-hub

Sensors

STE-8001W80	SimplyVAV sensor and digital display
STE-8201W80	SimplyVAV sensor and digital display with motion sensor
STE-6010W80	Discrete temperature sensor with RJ-45 connector
STE-6014W80	Discrete temperature sensor with rotary setpoint dial, RJ-45 connector
STE-6017W80	Discrete temperature sensor with rotary setpoint dial, override button, RJ-45 connector
HPO-9005	Room Sensor Adapter

Sensor cables

HSO-9001	Cable: Ethernet, 50 foot
HSO-9011	Cable: Ethernet, 50 foot, Plenum Rated

Surge suppressors

KMD-5567	EIA-485 surge suppressor for MS/TP networks
----------	---

Replacement parts

HPO-0054	Replacement bulbs
HPO-0063	Replacement two-pin jumper

Dual duct actuator

TSP-8001	VAV actuator with airflow inputs (required for dual duct)
----------	---

Airflow sensors

For VAV terminal units without airflow pickup tubes, order one of the following sensors.

SSS-1012	3-5/32 in. length (80 mm)
SSS-1013	5-13/32 in. length (137 mm)
SSS-1014	7-21/32 in. length (195 mm)
SSS-1015	9-29/32 in. length (252 mm)
KIT-8001	A 3-5/32 inch sensor and 3 feet of FR tubing

Available models

The following is a list of SimplyVAV available models.

Description	Models
BACnet ASC: VAV Cooling/Heating only, 40 in-lbs, 90 second actuator	BAC-8001
BACnet ASC: VAV Fan and Reheat, 40 in-lbs, 90 second actuator	BAC-8005
BACnet ASC: VAV Dual Duct, 40 in-lbs, 90 second actuator	BAC-8007
BACnet ASC: VAV Fan and Reheat, True damper position, 40 in-lbs, 60 second actuator	BAC-8205

Safety considerations

KMC Controls assumes the responsibility for providing you a safe product and safety guidelines during its use. Safety means protection to all individuals who install, operate, and service the equipment as well as protection of the equipment itself. To promote safety, we use hazard alert labeling in this manual. Follow the associated guidelines to avoid hazards.



Danger represents the most severe hazard alert. Bodily harm or death will occur if danger guidelines are not followed.



Warning represents hazards that could result in severe injury or death.



Caution indicates potential personal injury or equipment or property damage if instructions are not followed.

Note: Notes provide additional information that is important.

Tip: Provides programing tips and shortcuts that may save time.

Section 2: Installing the controllers

This section provides important instructions and guidelines for installing the SimplyVAV controllers. Carefully review this information before installing the controller.

Installing SimplyVAV includes the following topics that are covered in this section.

Installation topics in this section

Setting the rotation limits	13
Mounting on a VAV terminal box	14
Connecting an airflow sensor	15
Connecting inputs and outputs	15
Connecting room temperature sensors	15
Connecting a DAT sensor	16
Connecting power	17
Maintenance	18

Setting the rotation limits

SimplyVAV controllers are manufactured for a damper that rotates 90 degrees from open to close. If the VAV damper is not a 90 degree damper, set the rotation limits to 45 or 60 degrees before mounting the controller.



Caution

Before setting the rotation limits on the controller, refer to the damper position specifications in the VAV control box to which the controller will be attached. Setting rotation limits that do not match the VAV damper may result in improper operation or equipment damage.

Illustration 2-1 Controller rotation limit selections

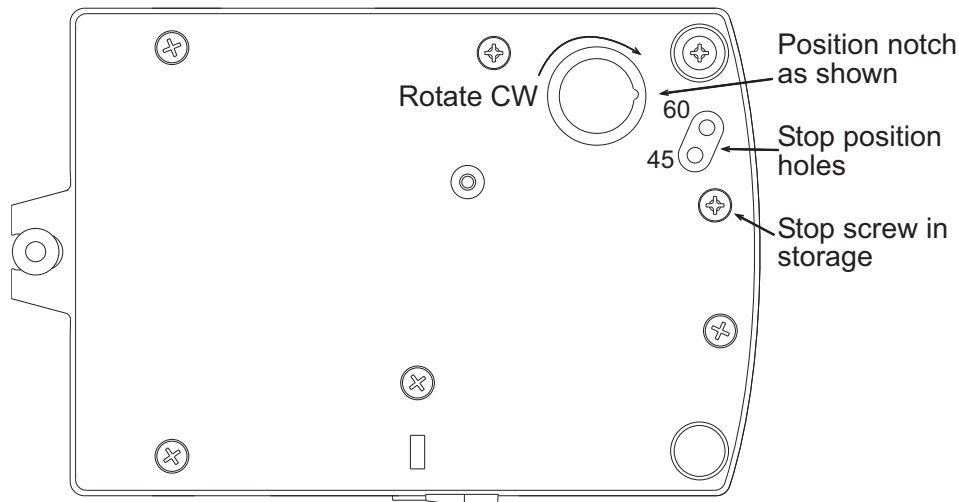

To set the rotational limits, do the following

- 1 Turn the controller over so you have access to the back.
- 2 Manually rotate the actuator fully clockwise as viewed from the back.
- 3 Remove the stop screw from its storage location and clean any debris from the threads.
- 4 Insert the screw into the correct stop position hole.
- 5 Tighten the screw only until the head touches the plastic in the bottom of the recess.

Mounting on a VAV terminal box

Mount the controller inside of a metal enclosure. To maintain RF emissions specifications, use either shielded connecting cables or enclose all cables in conduit.

Mount the controller directly over the damper shaft. A minimum shaft length of 2.0 inch (51 mm) is required.

Note: SimplyVAV controllers are designed to directly mount to 3/8 to 5/8 inch (9.5 to 16 mm) round or 3/8 to 7/16 inch (9.5 to 11 mm) square damper shafts.

Illustration 2-2 Controls and indicators

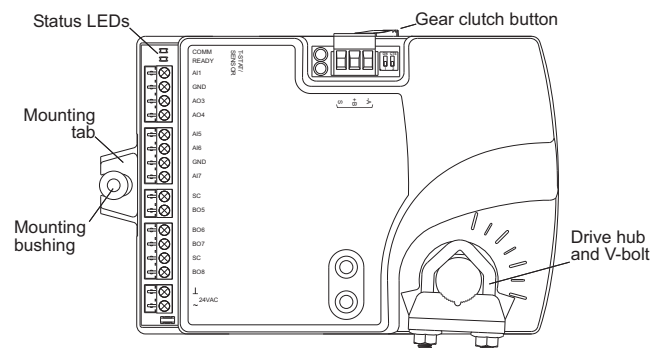

Mount the controller as follows:

- 1 Manually rotate the damper on the VAV box to the fully open position.
- 2 On the controller, press the gear clutch button and rotate the drive hub in the same direction that opened the damper. Turn the hub until it reaches a rotation limit.
- 3 Loosen the nuts on the V-bolt until the damper shaft can fit through the collar.
- 4 Place the controller over the damper shaft.
- 5 Finger tighten the nuts on the V-bolt to position the shaft in the drive hub.
- 6 Center the mounting bushing in the mounting tab and fasten it with a #8 sheet metal screw.
- 7 Evenly tighten the V-bolt nuts on the drive hub to 30-35 in-lbs.

Connecting an airflow sensor

An airflow sensor is incorporated as one of the inputs to the controller. Remove the plugs and connect the tubing from the pitot assembly to the airflow sensor inputs next to the drive hub.

Illustration 2-3 Airflow sensor inputs

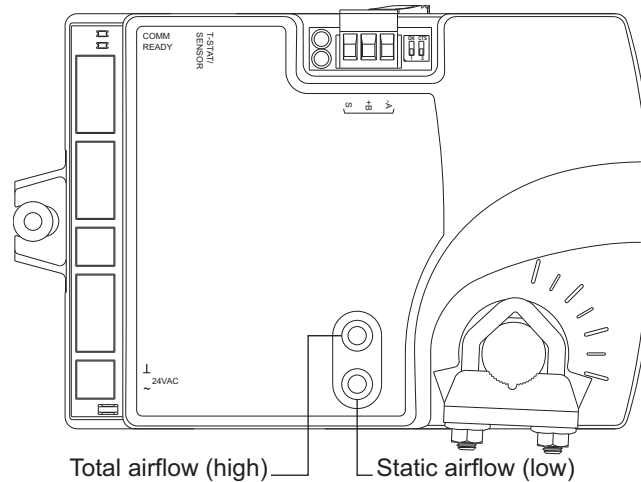

Typically, airflow sensors are supplied by the manufacturer as part of the VAV terminal unit. If a sensor is needed, choose a sensor listed in the topic [Accessories and replacement parts on page 9](#).

Connecting inputs and outputs

SimplyVAV series controllers have preconfigured inputs and outputs to support only the supplied programs and applications.

- For input and output connection information, see the topic [Application drawings on page 41](#).
- To connect room temperature sensors, see the topic [Connecting room temperature sensors on page 15](#)
- To connect a DAT sensor, see the topic [Connecting a DAT sensor on page 16](#).
- For the BACnet object descriptions of the inputs and outputs, see the topic [BACnet objects on page 67](#).

Connecting room temperature sensors

Connect any of the following sensors to the RJ-45 thermostat and sensor jack. The controller automatically detects the type of sensor. No programming or configuration is required.

- STE-6010W80
- STE-6014W80
- STE-6017W80
- STE-8001W80
- STE-8201W80

Connect the controller to sensors with standard Ethernet cables up to 75 feet long. See the installation guide supplied with the sensors for sensor installation instructions.

Illustration 2-4 Connecting to a sensor

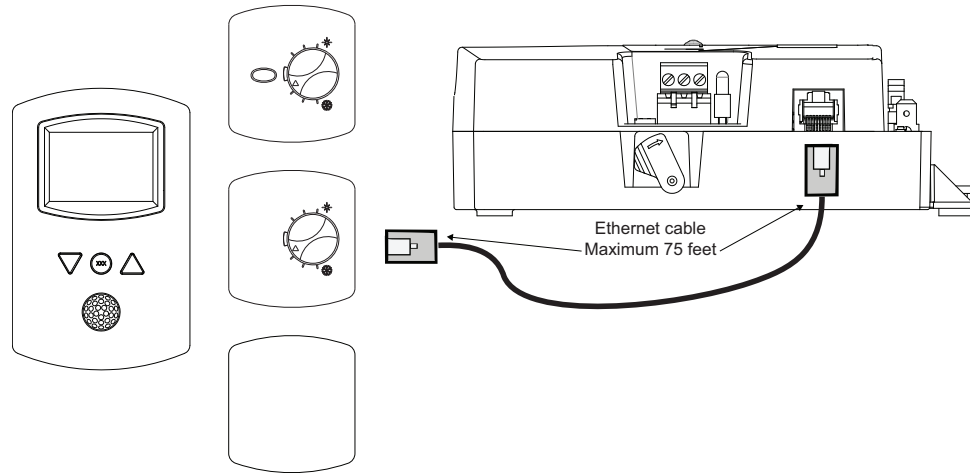

Connecting a DAT sensor

The Discharge Air Temperature sensor is required for automatic changeover and for VAV terminal units with reheat.

Illustration 2-5 Discharge air temperature sensor location

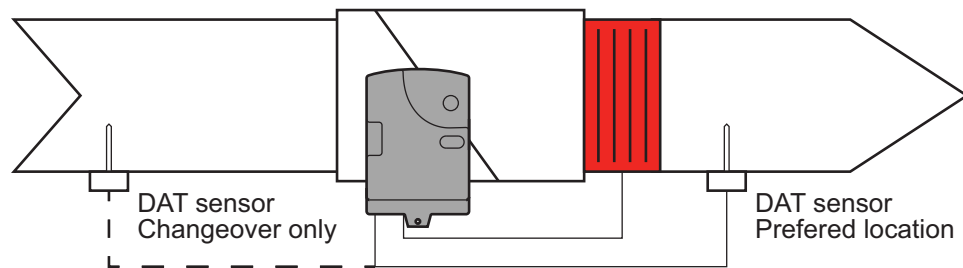

Connect a 10 kΩ, Type 3 thermistor temperature probe to the discharge air temperature input. The input includes the internal pull-up resistor. An STE-1401 sensor is suitable for this application. Follow the instructions supplied with the sensor for installation.

- For DAT limiting and reheat, install the sensor in the airflow after the reheat unit. See the topic, [Advanced options on page 33](#) to enable discharge air temperature control.
- When the DAT sensor is used only to detect primary air temperature, the sensor can be placed in either location shown in the illustration [Discharge air temperature sensor location](#).

Illustration 2-6 Discharge air temperature input details

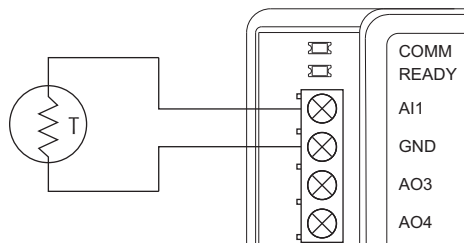

Connecting power

The controllers require a 24 volt, AC power source. Use the following guidelines when choosing and wiring transformers to the controller.

- Use a Class-2 transformer of the appropriate size to supply power to the controller.
- KMC Controls recommends powering only one controller from each transformer.
- Do not run 24 volt, AC power from within an enclosure to external controllers.

Connect the 24 volt AC power supply to the power terminal block on the lower right side of the controller. Connect the ground side of the transformer to the ground terminal **⊥** and the AC phase to the phase **~** terminal. Power is applied to the controller when the transformer is connected to power.

Illustration 2-7 Controller power terminals

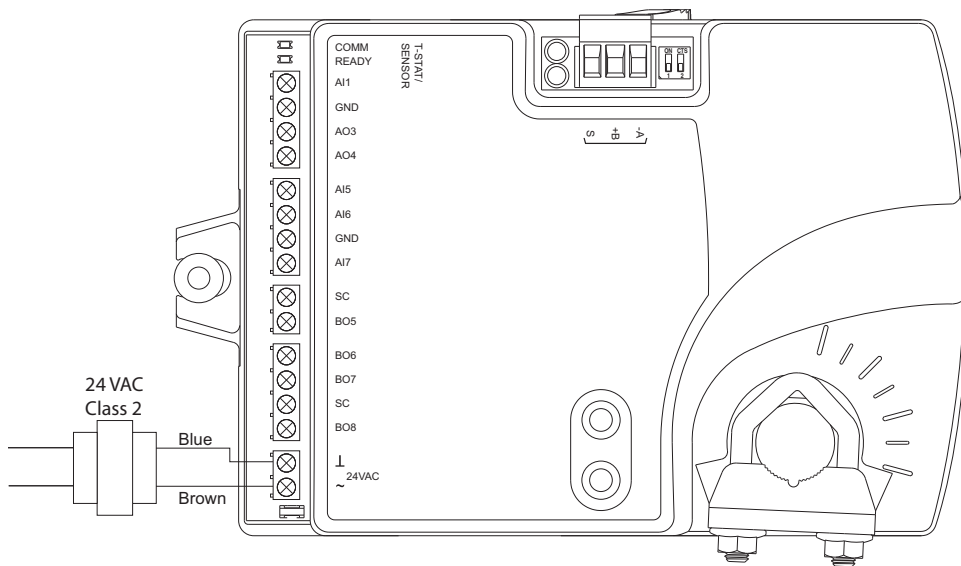

Maintenance

SimplyVAV controllers require no routine maintenance. If necessary, clean with a damp cloth and mild soap.

Section 3: Changing the room setpoint

This section covers topics for the end user in a facility.

Changing the SimplyVAV user functions with an STE-8001 or STE-8201 are limited to changing the active setpoints in a room. The setpoints are entered or changed using the buttons and display on the front of the sensor.

Quick start to changing setpoints

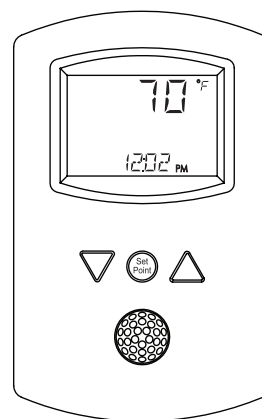

1. Press any button to begin changing setpoints.
2. If required, enter Password 1.
3. Press the up Δ or down ∇ buttons to change a setpoint value.
4. Press the \odot button to save the value or advance to the next function.



To enter or change the active setpoints you may need Password 1.

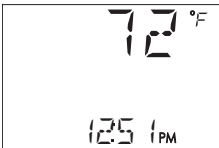

Tip: Once the following procedure is started, all steps must be completed in order.

Changing room setpoints

Procedure	Steps	Sensor display
1 Starting display	Start from the temperature display.	
2 Enter Password 1.	<ol style="list-style-type: none"> 1. Press any button. The display changes to PSW 1. 2. Press the Δ or ∇ buttons to change the first digit. 3. Press the \odot button to select the next digit. Repeat for all four digits. 	

Note: If Password 1 has not previously been entered, the display will change to the occupied cooling setpoint display after Step 1.

Changing room setpoints (continued)

Procedure	Steps	Sensor display
3 Set the active cooling setpoint.	<ol style="list-style-type: none"> 1. Press the Δ or ∇ buttons to change the cooling setpoint temperature. The setpoint changes in increments of 0.5 degrees. 2. Press the \odot button to save the value. The display advances to set the heating setpoint. 	 <p>The sensor display shows a temperature of 74.5°F. Above the temperature, the word 'OCCUPIED' is on the left and 'SETPOINT' is on the right. Below the temperature is a snowflake icon, and at the bottom, the word 'COOLING' is displayed.</p>
4 Set the active heating setpoint.	<ol style="list-style-type: none"> 1. Press the Δ or ∇ buttons to change the heating setpoint temperature. The setpoint changes in increments of 0.5 degrees. 2. Press the \odot button to save the value. The display returns to the temperature display. 	 <p>The sensor display shows a temperature of 68.5°F. Above the temperature, the word 'OCCUPIED' is on the left and 'SETPOINT' is on the right. Below the temperature is a flame icon, and at the bottom, the word 'HEATING' is displayed.</p>

Section 4: **Configuring the controllers**

This topics in this section are advanced topics for control technicians and engineers.

The configuration functions that are accessible through an STE-8000 series digital sensor are all of the values and settings that are entered during the installation and commissioning of a VAV terminal unit. Typically, these functions do not change after the installation and commissioning process.

To set up the configuration functions, you will need the following items and information.

- Details about the VAV terminal unit including the configuration for fans and reheat.
- An STE-8001 or STE-8201 digital sensor to use as a configuration tool.
- The building automation system plans for controllers connected to a network.

Users may change the active heating and cooling setpoints without accessing the configuration functions. This procedure is covered in the topic [Changing the room setpoint on page 19](#).

Note: The instructions for the configuration functions cover all of the functions that a digital sensor can set up in the SimplyVAV series of controllers. Not all functions are available on every model of controller.

Configuration topics



Getting started with configuration	21
Entering system temperature setpoints and limits	23
Configuring the VAV Box options	27
Set the airflow setpoints	29
Advanced options	33
Restore Application	35

Getting started with configuration

For access to the configuration functions you will need the Password 2.

- If the controller has not been previously set up, no password is required.
- A new Password 2 can be entered or changed in the advance functions. See the topic [Advanced options on page 33](#).

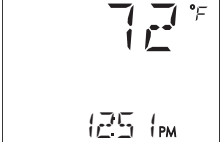
Enter the configuration mode

Procedure	Detailed steps	Sensor display
1 Starting display	<ol style="list-style-type: none"> 1. Start at the temperature display. 2. Press the Δ and ∇ buttons together. <ul style="list-style-type: none"> • If Password 2 is not required, the display changes to CNFG. • If required, enter Password 2. The display changes to CNFG when Password 2 is correct. 	
2 Enter Password 2.	<ol style="list-style-type: none"> 1. Press the Δ and ∇ buttons together and hold them down until the display changes to PSW2. 2. Press the Δ or ∇ button to change the first digit. 3. Press the \odot button to select the next digit. Repeat for all four digits. 4. When the button is pushed for the fourth correct digit, the display changes to COMM. <p>Note: If Password 2 has not previously been entered the display will change to the CNFG display after Step 1.</p>	
3 Select a configuration function.	Access to the configuration functions always start at the CNFG display.	

Entering system temperature setpoints and limits

The system temperature setpoints set the operational parameters and limits for the VAV terminal unit.





The temperature setpoints include the following items.

- Minimum cooling and maximum heating setpoints
- Occupied and unoccupied cooling setpoints
- Occupied and unoccupied heating setpoints
- Changeover differential setpoint
- Standby differential setpoint

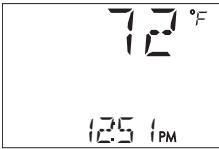

Setting the temperature setpoints requires entering Password 2 which is described in detail in the topic [Getting started with configuration on page 21](#).

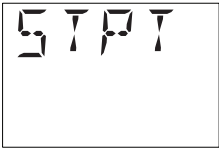
Tip: Once the following procedure is started, all steps must be completed in order.



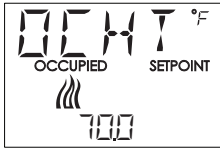

Procedure to set the temperature setpoints

Procedure	Detailed steps	Sensor display
1 Start at the temperature display.	1. Start at the temperature display.	
	2. Press the Δ and ∇ buttons together. <ul style="list-style-type: none"> • If Password 2 is not required, the display changes to CNFG. • If required, enter Password 2. The display changes to CNFG when Password 2 is correct. 	
2 Select the setpoint display.	1. From the CNFG display, press the Δ or ∇ buttons to show STPT .	
	2. Press the \odot button to select the CNFG options. The display changes to STPT .	
	3. Press the \odot button to select STPT . The display changes to MIN .	
3 Set the minimum cooling setpoint.	This setpoint limits the lowest temperature that a user can enter as the active setpoint.	

Procedure to set the temperature setpoints (continued)

Procedure	Detailed steps	Sensor display
4 Set the maximum heating setpoint.	<ol style="list-style-type: none"> 1. Press the Δ or ∇ buttons to set the minimum cooling setpoint. The setpoint will change in 0.5° increments. 2. Press the \odot button to save the setpoint and advance to the next function. 	
5 Set the occupied cooling setpoint.	<p>This setpoint is used as the active setpoint when the space is occupied.</p> <ol style="list-style-type: none"> 1. Press the Δ or ∇ buttons to set the occupied cooling setpoint. The setpoint will change in 0.5° increments. 2. Press the \odot button to save the setpoint and advance to the next function. <p>Note: This setpoint can also be changed as described in the topic Changing the room setpoint on page 19.</p>	
6 Set the occupied heating setpoint.	<p>This setpoint is used as the active setpoint when the space is occupied.</p> <ol style="list-style-type: none"> 1. Press the Δ or ∇ buttons to set the occupied heating setpoint. The setpoint will change in 0.5° increments. 2. Press the \odot button to save the setpoint and advance to the next function. <p>Note: This setpoint can also be changed as described in the section Changing the room setpoint on page 19.</p>	

Procedure to set the temperature setpoints (continued)

Procedure	Detailed steps	Sensor display
7 Set the unoccupied cooling setpoint.	<p>This setpoint is used as the active setpoint when the space is unoccupied.</p> <ol style="list-style-type: none"> 1. Press the Δ or ∇ buttons to set the unoccupied cooling setpoint. The setpoint will change in 0.5° increments. 2. Press the \odot button to save the setpoint and advance to the next function. 	
8 Set the unoccupied heating setpoint.	<p>This setpoint is used as the active setpoint when the space is unoccupied.</p> <ol style="list-style-type: none"> 1. Press the Δ or ∇ buttons to set the unoccupied heating setpoint. The setpoint will change in 0.5° increments. 2. Press the \odot button to save the setpoint and advance to the next function. 	
9 Set the supply air temperature changeover setpoint. <i>Not used in all models.</i>	<p>This setpoint sets the supply air temperature at which the controller will change between heating to cooling.</p> <ol style="list-style-type: none"> 1. Press the Δ or ∇ buttons to set the changeover setpoint. The setpoint will change in 1° increments. 2. Press the \odot button to save the setpoint and advance to the next function. 	
10 Set the minimum temperature differential setpoint.	<p>The minimum allowable temperature value between the cooling and heating setpoints.</p> <ol style="list-style-type: none"> 1. Press the Δ or ∇ buttons to set the differential setpoint. The setpoint will change in 1° increments. 2. Press the \odot button to save the setpoint and advance to the next function. 	
11 Set the standby differential setpoint.	<p>The standby setpoint is calculated by adding or subtracting the offset value to or from the value of the occupied setpoint.</p> <ol style="list-style-type: none"> 1. Press the Δ or ∇ buttons to set the standby differential setpoint. The setpoint will change in 1° increments. 2. Press the \odot button to save the setpoint and advance to the next function. 	

Procedure to set the temperature setpoints (continued)

Procedure	Detailed steps	Sensor display
12 Select a new configuration function or exit.	<ol style="list-style-type: none">1. Press the Δ or ∇ buttons to select one of the following:<ul style="list-style-type: none">• 30%, FLOW, ADVC, or RSTR options• BACK to choose another configuration function.• EXIT to return to the temperature display.2. Press the \odot button to select the next function.	 A rectangular box representing a sensor display. Inside the box, the characters 'STPT' are displayed in a large, black, monospaced font, centered horizontally and vertically.

Configuring the VAV Box options







The box options set the controller for the specific mechanical installation of the VAV terminal unit. The box options include the following items.

- The K-factor for the VAV terminal unit. If the K-factor is not available, see the topic [K-factors on page 71](#).
- Reheat configuration (optional)
- Fan configuration (optional)
- Direction of damper to close

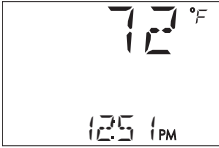

Setting the box options requires entering Password 2 which is described in the topic [Getting started with configuration on page 21](#).

Tip: Once the following procedure is started, all steps must be completed in order.

Procedure to set the box functions

Procedure	Detailed steps	Sensor display
1 Starting display	<ol style="list-style-type: none"> 1. Start at the temperature display. 2. Press the Δ and ∇ buttons together. <ul style="list-style-type: none"> • If Password 2 is not required, the display changes to ENFG. • If required, enter Password 2. The display changes to ENFG when Password 2 is correct. 	 
2 Select the box settings display.	<ol style="list-style-type: none"> 1. From the ENFG display, press the Δ or ∇ buttons to show the 30x display. 2. Press the \odot button to select the ENFG options. The display changes to STPT. 3. Press the Δ or ∇ buttons to change the display to 30x. 4. Press the \odot button to select 30x. 	  
3 Set the primary VAV terminal unit K-factor.	The K-factor is supplied by the manufacturer of the VAV terminal unit. Typically it is on the label with the unit airflow information.	

Procedure to set the box functions (continued)

Procedure	Detailed steps	Sensor display
	<ol style="list-style-type: none"> Press the Δ or ∇ buttons to set the primary K-factor. Press the \odot button to save the entry and advance to the next function. 	
<p>4 Set the secondary VAV terminal unit K-factor.</p> <p><i>Not used in all models.</i></p>	<p>The K-factor is supplied by the manufacturer of the VAV terminal unit. Typically it is on the label with the unit airflow information.</p> <ol style="list-style-type: none"> Press the Δ or ∇ buttons to set the secondary K-factor. Press the \odot button to save the entry and advance to the next function. 	
<p>5 Set the mode of reheat for the terminal unit.</p> <p><i>Not used in all models.</i></p>	<ol style="list-style-type: none"> Press the Δ or ∇ buttons to choose one of the following reheat options. <ul style="list-style-type: none"> None—Reheat is not enabled. Staged—Enables staged reheat. Modulating—The analog reheat output varies from 0-10 volts DC. Floating—The reheat outputs control a tristate actuator. Time proportional—A 24-volt triac output controls a thermal wax valve. Press the \odot button to save the reheat option and advance to the next function. 	
<p>6 Set the fan option.</p> <p><i>Not used in all models.</i></p>	<ol style="list-style-type: none"> Press the Δ or ∇ buttons to choose one of the following fan options. <ul style="list-style-type: none"> None—No fan is connected to the controller. Series—The VAV unit includes a series fan. Parallel—The VAV unit includes a parallel fan. Press the \odot button to save the fan option and advance to the next function. 	

Procedure to set the box functions (continued)

Procedure	Detailed steps	Sensor display
7 Set the damper direction to close.	<ol style="list-style-type: none"> Press the Δ or ∇ buttons to which direction to damper moves to close. <p>CCW—The actuator turns counterclockwise to close the damper.</p> <p>CW—The actuator turns clockwise to close the damper.</p> Press the \odot button to save the damper option and advance to the next function. 	<p>The sensor display shows the word 'AIR' in large characters at the top and 'CCW' in smaller characters below it.</p>
8 Select a new configuration function or exit.	<ol style="list-style-type: none"> Press the Δ or ∇ buttons to select one of the following: <ul style="list-style-type: none"> STPT, FLOW, ADJC. or RSTR options BACK to choose another configuration function EXIT to return to the temperature display. Press the \odot button to select the next function. 	<p>The sensor display shows the word 'BOX' in large characters.</p>

Set the airflow setpoints

The airflow setpoints set the airflow limits for the VAV terminal unit.







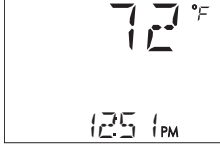

- Airflow heating and cooling minimum and maximum limits
- Auxiliary flow setpoint (optional)
- Minimum and maximum fan speeds (optional)

Setting the airflow setpoints requires entering Password 2 which is described in the topic [Getting started with configuration on page 21](#).

Note: If the VAV unit is a heat only or cooling only unit, the airflow setpoints for the unused mode must be set within the range of the mode in use. Failure to set the unused setpoints correctly will result in unpredictable or erroneous air balancing settings.

Tip: Once the following procedure is started, all steps must be completed in order.

Procedure to set the airflow setpoints

Procedure	Detailed steps	Sensor display
1 Starting display	<ol style="list-style-type: none"> 1. Start at the temperature display. 2. Press the Δ and ∇ buttons together. <ul style="list-style-type: none"> • If Password 2 is not required, the display changes to CNFG. • If required, enter Password 2. The display changes to CNFG when Password 2 is correct. 	 
2 Select the flow setpoint display.	<ol style="list-style-type: none"> 1. From the CNFG display, press the Δ or ∇ buttons to show the CNFG display. 2. Press the \odot button to select the CNFG options. The display changes to STPT. 3. Press the Δ or ∇ buttons to change the display to FLOW. 4. Press the \odot button to select FLOW. The display changes to MINCL. 	  
3 Set the cooling minimum airflow limit.	<ol style="list-style-type: none"> 1. Press the Δ or ∇ buttons to set the minimum limit for cooling airflow. The setpoint changes in 1 CFM increments. 2. Press the \odot button to save the setpoint and advance to the next function. 	
4 Set the cooling maximum airflow limit.	<ol style="list-style-type: none"> 1. Press the Δ or ∇ buttons to set the maximum limit for cooling airflow. The setpoint changes in 1 CFM increments. 2. Press the \odot button to save the setpoint and advance to the next function. 	
5 Set the axillary airflow setpoint.	<p>This setpoint sets the airflow for when reheat is active auxiliary airflow.</p>	
<i>Not used for all models.</i>		

Procedure to set the airflow setpoints (continued)

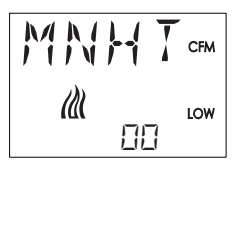
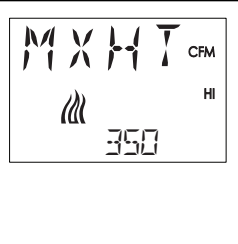
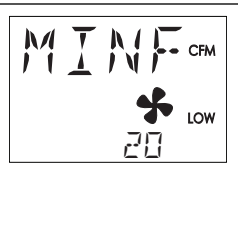
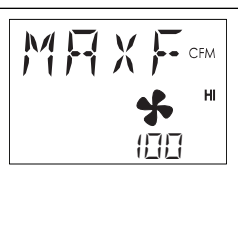
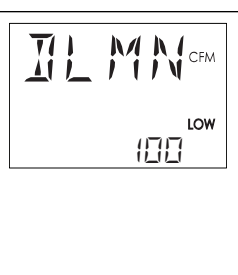
Procedure	Detailed steps	Sensor display
	<ol style="list-style-type: none"> 1. Press the Δ or ∇ buttons to set a value for the auxillary airflow. The setpoint changes in 1 CFM increments. 2. Press the \odot button to save the setpoint and advance to the next function. 	
<p>6 Set the heating minimum airflow limit</p>	<ol style="list-style-type: none"> 1. Press the Δ or ∇ buttons to set the minimum limit for heating airflow. The setpoint will change in 1 CFM increments. 2. Press the \odot button to save the setpoint and advance to the next function. 	
<p>7 Set the heating maximum airflow limit.</p>	<ol style="list-style-type: none"> 1. Press the Δ or ∇ buttons to set the maximum limit for heating airflow. The setpoint will change in 1 CFM increments. 2. Press the \odot button to save the setpoint and advance to the next function. 	
<p>8 Set the minimum limit for fan speed.</p> <p><i>Not used for all models.</i></p>	<ol style="list-style-type: none"> 1. Press the Δ or ∇ buttons to set the minimum limit for the fan speed. The setpoint will change in 1% increments. 2. Press the \odot button to save the setpoint and advance to the next function. 	
<p>9 Set the maximum limit for fan speed.</p> <p><i>Not used for all models.</i></p>	<ol style="list-style-type: none"> 1. Press the Δ or ∇ buttons to set the maximum limit for the fan speed. The setpoint will change in 1% increments. 2. Press the \odot button to save the setpoint and advance to the next function. 	
<p>10 Set the dual duct minimum airflow.</p> <p><i>Not used for all models.</i></p>	<p>This setpoint is for the minimum airflow when a dual-duct system is at temperature setpoint.</p> <ol style="list-style-type: none"> 1. Press the Δ or ∇ buttons. 2. Press the \odot button to save the setpoint and advance to the next function. 	

Procedure to set the airflow setpoints (continued)

Procedure	Detailed steps	Sensor display
11 Select a new configuration function or exit.	<ol style="list-style-type: none">1. Press the Δ or ∇ buttons to select one of the following:<ul style="list-style-type: none">• STPT, BOX, ADVC, or RSTR options• BACK to choose another configuration function• EXIT.2. Press the \odot button to select the next function.	

Advanced options







The advanced options set up passwords and special features in the controller.

- Establish or change Password 1 and Password 2
- Set timers for standby and override (optional)
- Enable automatic occupancy (optional)
- Enable discharge air temperature control (optional)
- Calibrate the sensor



















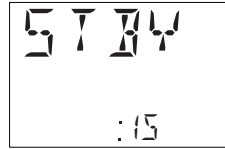

Setting the advance options requires entering Password 2 which is described in the topic [Getting started with configuration on page 21](#).

Tip: Once the following procedure is started, all steps must be completed in order.



Table 4-1 Procedure to set the advanced options

Procedure	Steps	Sensor display
1 Starting display	1. Start at the temperature display.	
	2. Press the Δ and ∇ buttons together. <ul style="list-style-type: none"> • If Password 2 is not required, the display changes to ENFG. • If required, enter Password 2. The display changes to ENFG when Password 2 is correct. 	
2 Select the advanced display.	1. From the ENFG display, press the \odot button to show the STPT display.	 
	2. Press the Δ or ∇ buttons to change the display to ADVC .	
	3. Press the \odot button to select ADVC .	
3 Change Password 1.	Note: Entering four zeros (0000) removes the password.	
	1. Press the Δ or ∇ buttons to change the first digit. 2. Press the \odot button to select the next digit. Repeat for all four digits.	

Procedure to set the advanced options (continued)

Procedure	Steps	Sensor display
	3. When the  button is pressed for the last digit, the new password is saved and the display advances.	
4 Change Password 2. <i>Applies only to STE-6017 sensors.</i>	Note: Entering four zeros (0000) removes the password. 1. Press the  or  buttons to change the first digit. 2. Press the  button to select the next digit. Repeat for all four digits. 3. When the  button is pressed for the last digit, the new password is saved and the display advances.	
5 Set the local unoccupied override timer. <i>Applies only to STE-6017 sensors.</i>	1. Press the  or  buttons to set the local unoccupied override timer. The value will change in 1 minute increments. 2. Press the  button to save the setpoint and advance to the next function.	
6 Set the standby time <i>Applies only to STE-8201 digital sensors.</i>	1. Press the  or  buttons to set the time for the standby time. The value will change in 1 minute increments. 2. Press the  button to save the setpoint and advance to the next function.	
7 Set discharge air temperature limiting. <i>Not used for all models. Required for reheat.</i>	1. Press the  or  buttons to enable or disable discharge air temperature limiting. 2. Press the  button to save the setpoint and advance to the next function.	
8 Set the automatic occupancy mode. <i>Requires a discharge air temperature sensor.</i>	1. Press the  or  buttons to enable or disable automatic occupancy. 2. Press the  button to save the setpoint and advance to the next function. Enable The controller will automatically changed to the unoccupied state when it detects the loss of primary air supply. Disable The controller will remain in the occupied mode regardless of the primary air supply.	

Procedure to set the advanced options (continued)

Procedure	Steps	Sensor display
9 Set the temperature sensor calibration constant.	<ol style="list-style-type: none"> Press the Δ or ∇ buttons to set the calibration constant. The setpoint will change in 0.1 minute increments. <ul style="list-style-type: none"> For a low input reading enter a positive correction value. For a high input reading enter a negative correction value. Press the \odot button to save the setpoint and advance to the next function. 	
10 Select a new configuration function or exit.	<ol style="list-style-type: none"> Press the Δ or ∇ buttons to select one of the following: <ul style="list-style-type: none"> STPT, FLOW, BOX, or RSTR options BACK to choose another configuration function EXIT to return to the temperature display. Press the \odot button to select the next function. 	

Restore Application

Choose the RSTR function to reset the SimplyVAV controller to the original configuration and settings. Use it also to change the units of measure to display on a SimplyVAV sensor. There are two versions of the application program in the controller.

- The Metric version displays temperature in Celsius and uses metric values for units of measure.
- The English version displays temperature in Fahrenheit and uses English values for units of measure.







Access to the Restore Application function requires entering Password 2 which is described in the topic [Getting started with configuration on page 21](#).

Tip: Once the following procedure is started, all steps must be completed in order.

**Caution**

Choosing RSTR deletes all previously configured values including balancing values and passwords. Only the BACnet communications settings will remain unchanged.

Procedure to restore application

Procedure	Detailed steps	Sensor display
1 Starting display	<ol style="list-style-type: none"> 1. Start at the temperature display. 2. Press the Δ and ∇ buttons together. <ul style="list-style-type: none"> • If Password 2 is not required, the display changes to CNFG. • If required, enter Password 2. The display changes to CNFG when Password 2 is correct. 	 
2 Select the restore settings display.	<ol style="list-style-type: none"> 1. From the CNFG display, press the Δ or ∇ buttons to show the CNFG display. 2. Press the \odot button to select the CNFG options. The display changes to STPT. 3. Press the Δ or ∇ buttons to change the display to RSTR. <p>Caution: Choosing RSTR deletes all previously entered values and returns the controller to the manufacturer's settings. Only the BACnet communications settings will remain unchanged.</p> 4. Press the \odot button to select RSTR. 	  
3 Choose the application.	<ol style="list-style-type: none"> 1. Press the Δ or ∇ buttons to choose ENGLISH or METRIC. <p>Metric The sensor displays temperature in Celsius and uses metric values for units of measure.</p> <p>English The sensor displays temperature in Fahrenheit and uses English values for units of measure.</p> 2. Press the \odot button to save the entry and advance to the next function. 	 

Section 5: Balancing airflow

Topics in this section are for control technicians or engineers who will be balancing the airflow in the controllers.

The airflow balancing procedure described in this section requires the following items.

- A flow hood or other accurate method to measure airflow.
- An STE-8001 or STE-8201 wall sensor. If the system does not include one of these sensors, temporarily disconnect the installed sensor and connect an STE-8001 as a service tool.
- The engineering design specifications for the minimum and maximum airflow setpoints.
- Password 2 which is described in the topic [Getting started with configuration on page 21](#).

Note: If the VAV unit is a heat only or cooling only unit, the airflow setpoints for the unused mode must be set within the range of the mode in use. Failure to set the unused setpoints correctly will result in unpredictable or erroneous air balancing settings. See [Set the airflow setpoints on page 29](#) for the procedure to adjust the setpoints.





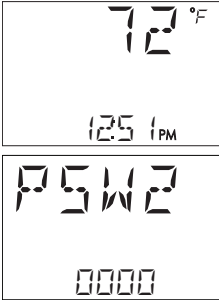

Note: Starting the balancing procedure erases all previous airflow correction factors. The airflow readings displayed by the digital sensor are the actual uncorrected airflow readings as measured by the controller.

Tip: Once the following procedure is started, all steps must be completed in order.





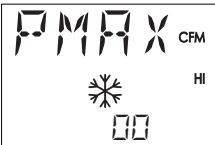







Table 5-1 The airflow balancing procedure

Procedure	Steps	Sensor display
1 Starting display	<ol style="list-style-type: none"> 1. Start at the temperature display. 2. Press the Δ and ∇ buttons together. <ul style="list-style-type: none"> • If Password 2 is not required, the display changes to ENFG. • If required, enter Password 2. The display changes to ENFG when Password 2 is correct. 	







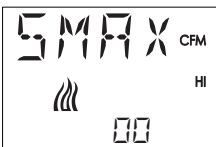

The airflow balancing procedure (continued)

Procedure	Steps	Sensor display
2 Select the CNFG display.	<ol style="list-style-type: none"> <li data-bbox="505 205 1130 281">From the CNFG display, press the Δ or ∇ buttons to advance to COMM and the BLNC display. <li data-bbox="505 548 1130 623">Press the \odot button to select BLNC. The display advances to PR I. <li data-bbox="505 737 1130 768">Press the \odot button to select PR I. 	   
3 Measure and enter the actual maximum primary airflow	<p>The display begins flashing PMAx and also displays the actual airflow at the bottom.</p> <p>Note: The airflow will attempt to stabilize on the highest value for either the cooling or heating maximum airflow even if only one mode is operational.</p> <p>Note: The airflow displayed by the digital sensor in this step is the actual, uncorrected airflow.</p> <ol style="list-style-type: none"> <li data-bbox="505 1247 1130 1278">Wait for the maximum airflow value to stabilize. <li data-bbox="505 1295 1130 1327">With a flow hood, measure the actual airflow. <li data-bbox="505 1344 1130 1419">Press the \odot button to advance to the entry display. PMAx stops flashing. <li data-bbox="505 1436 1130 1512">Press the Δ or ∇ buttons to enter the measured airflow. <li data-bbox="505 1528 1130 1604">Press the \odot button to save the measured airflow. The display changes to PM IN. 	
4 Measure and enter the actual minimum primary airflow	<p>The display begins flashing PM IN and also displays the actual airflow at the bottom.</p>	

The airflow balancing procedure (continued)

Procedure	Steps	Sensor display
	<p>Note: The airflow will attempt to stabilize on the lowest value for either the cooling or heating minimum airflow even if only one mode is operational.</p> <p>Note: The airflow displayed by the digital sensor in this step is the actual, uncorrected airflow.</p> <ol style="list-style-type: none"> 1. Wait for the minimum airflow value to stabilize. 2. With a flow hood, measure the actual airflow. 3. Press the  button to advance to the entry display. PM IN stops flashing. 4. Press the  or  buttons to enter the measured airflow. 5. Press the  button to save the measured airflow. The display advances to PR I. 	
5 Advance or exit	<ol style="list-style-type: none"> 1. Press the  or  buttons to select one of the following: <ul style="list-style-type: none"> • SEC to balance the secondary VAV for dual duct systems. Choosing SEC advances to the SMAx display. This is available only on dual duct models. • BACK to choose another commissioning function • EXIT to return to the temperature display. 2. Press the  button to select the next function. 	 
6 Measure and enter the actual maximum secondary airflow	<p>The display begins flashing SMAx and also displays the actual airflow at the bottom.</p> <p>Note: The airflow displayed by the digital sensor in this step is the actual, uncorrected airflow.</p> <ol style="list-style-type: none"> 1. Wait for the maximum airflow value to stabilize. 2. With a flow hood, measure the actual airflow. 3. Press the  button to advance to the entry display. SMAx stops flashing. 4. Press the  or  buttons to enter the measured airflow. 5. Press the  button to save the measured airflow. The display advances to SM IN. 	

The airflow balancing procedure (continued)

Procedure	Steps	Sensor display
7 Measure and enter the actual minimum secondary airflow	<p>The display begins flashing SM IN and also displays the actual airflow at the bottom.</p> <p>Note: The airflow displayed by the digital sensor in this step is the actual, uncorrected airflow.</p> <ol style="list-style-type: none"> 1. Wait for the minimum airflow value to stabilize. 2. With a flow hood, measure the actual airflow. 3. Press the  button to advance to the entry display. SM IN stops flashing. 4. Press the  or  buttons to enter the measured airflow. 5. Press the  button to save the measured airflow. The display advances to SEC. 	
8 Advance or exit	<ol style="list-style-type: none"> 1. Press the  or  buttons to select one of the following: <ul style="list-style-type: none"> • PR I to balance the primary VAV for dual duct systems • BACK to choose another configuration function. • EXIT to return to the temperature display. 2. Press the  button to select the next function. 	

Section 6: Application drawings

This section covers the drawings, materials, and instructions for specific VAV applications.

Each SimplyVAV model is designed for a specific set of applications. The following topics are for control technicians and engineers that will plan for and install controllers for SimplyVAV applications.

Submittal sheets for all of these applications are available from the [BAC-8000 series](#) page at [KMCControls.com](#).

Application drawings in this section

Cooling or heating without reheat	42
Staged reheat	43
Modulating reheat	44
Time proportional reheat	45
Floating reheat	46
Dual-duct application	47

Cooling or heating without reheat

The BAC-8001 is configured for single-duct cooling VAV control without reheat. Connect the controller as shown in the illustration [Cooling or heating application drawing on page 42](#). A BAC-8005 or BAC-8205 may also be used for this application.

For cooling and heating, a duct temperature sensor is required for Discharge Air Temperature limiting and automatic changeover. See the topic [Advanced options on page 33](#) for instructions to enable Discharge Air Temperature limiting.

Submittal sheets for several variations of this application are available from the [BAC-8000 series](#) page at KMCControls.com.

Illustration 6-1 Cooling or heating application drawing

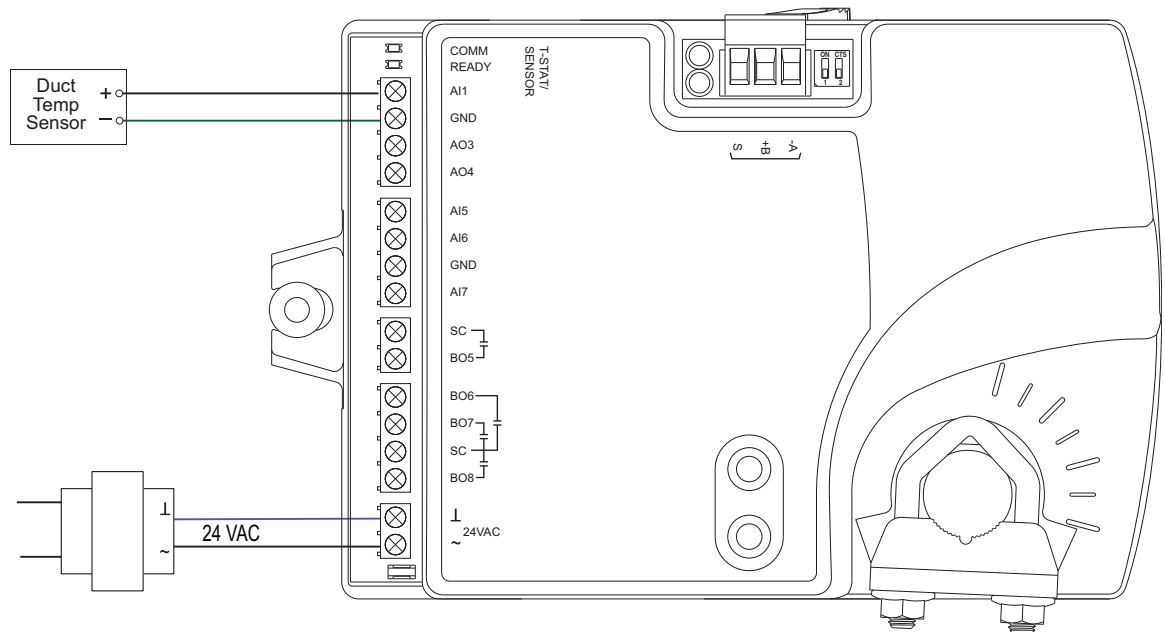

Staged reheat

The staged reheat application is for BAC-8005 or BAC-8205 controllers. The controllers are configured to switch reheat units that are controlled with 24 volts AC. Reheat units with up to three stages of reheat can be controlled by these controllers.

- For one-stage, electric reheat or hot water reheat with an on/off valve, use only output terminal B06.
- For two-stage reheat use output terminals B06 and B07.
- For three-stage reheat use output terminals B06, B07, and B08.

For cooling and heating, a duct temperature sensor is required for Discharge Air Temperature limiting and automatic changeover. See the topic [Advanced options on page 33](#) for instructions to enable Discharge Air Temperature limiting.

When connecting the controller to a fan powered VAV unit, the fan circuits must be compatible with the following specifications.

- The fan start circuit is a 24 volt AC pilot duty output.
- The fan speed output is 0-10 volts DC.

Submittal sheets for several variations of this application are available from the [BAC-8000 series](#) page at [KMCCcontrols.com](#).

Illustration 6-2 BAC-8005 and BAC-8205 with three-stage reheat

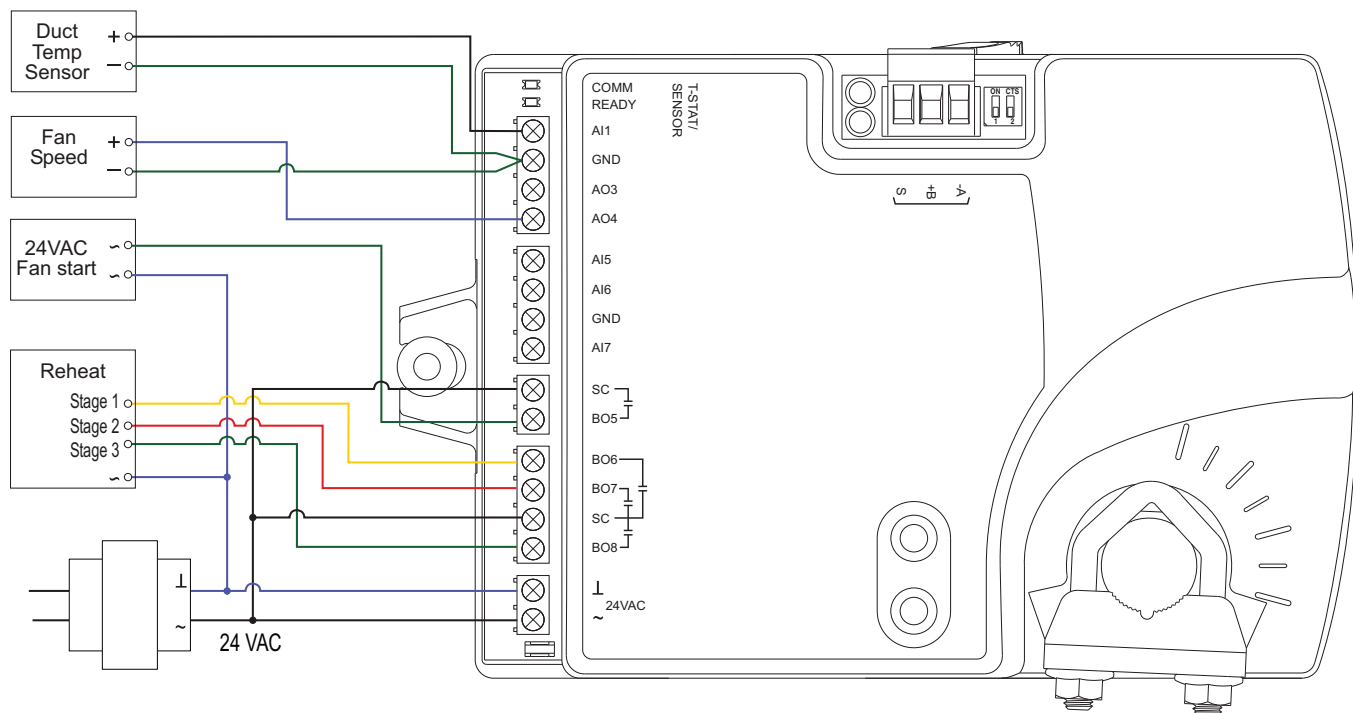

Modulating reheat

The modulating reheat application is for a BAC-8005 or BAC-8205 controller. The modulating option for reheat can control either an electric reheat unit with an analog input or a modulating hot water valve. The analog reheat output at output terminal AO3 varies between 0 and 10 volts DC.

For cooling and heating, a duct temperature sensor is required for Discharge Air Temperature limiting and automatic changeover. See the topic [Advanced options on page 33](#) for instructions to enable Discharge Air Temperature limiting.

When connecting the controller to a fan powered VAV unit, the fan circuits must be compatible with the following specifications.

- The fan start circuit is a 24 volt AC pilot duty output.
- The fan speed output is 0-10 volts DC.

Submittal sheets for several variations of this application are available from the [BAC-8000 series](#) page at [KMCCcontrols.com](#).

Illustration 6-3 Modulating reheat

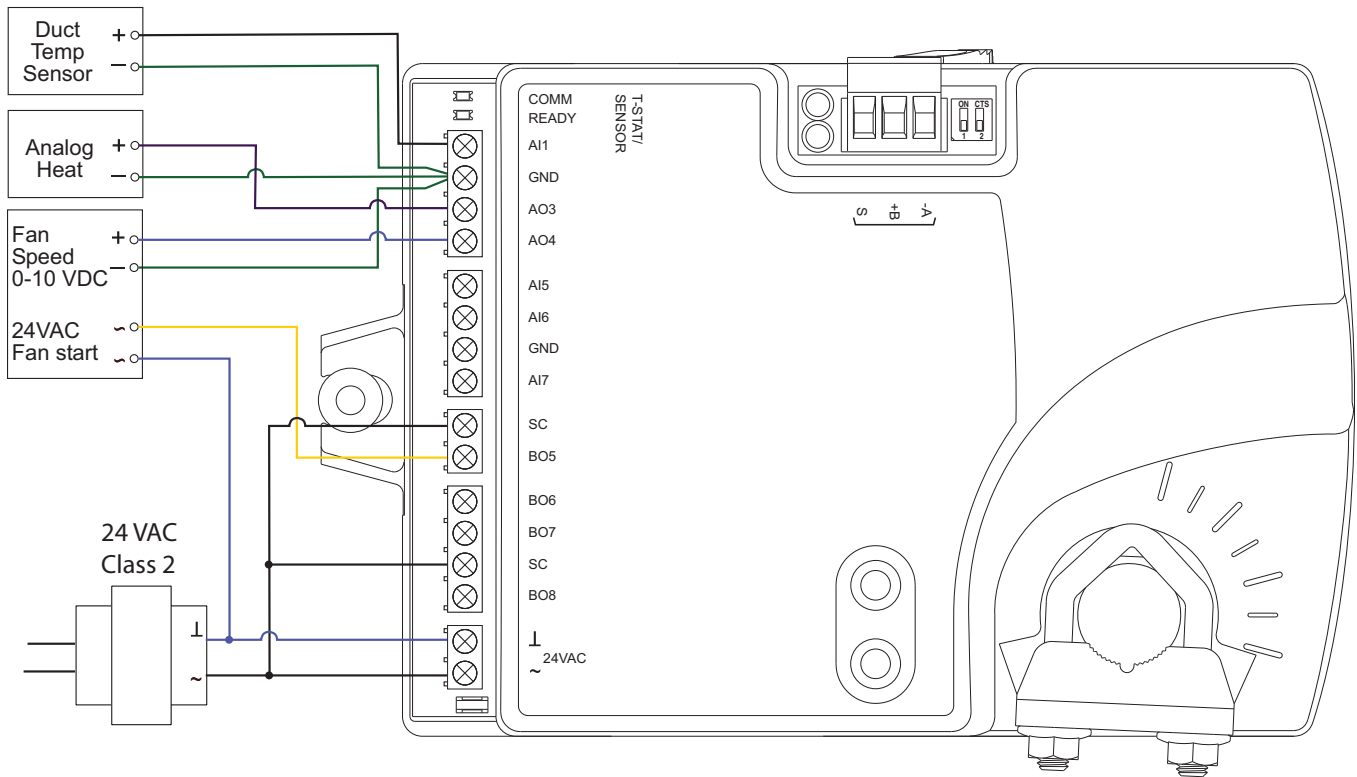

Time proportional reheat

The time proportional reheat application is for BAC-8005 or BAC-8205 controllers. This application is typically used in hydronic systems with a hot water reheat coil and a wax top control valve. The reheat output is a triac that can switch up to 1 ampere at 24 volts AC.

For cooling and heating, a duct temperature sensor is required for Discharge Air Temperature limiting and automatic changeover. See the topic [Advanced options on page 33](#) for instructions to enable Discharge Air Temperature limiting.

When connecting the controller to a fan powered VAV unit, the fan circuits must be compatible with the following specifications.

- The fan start circuit is a 24 volt AC pilot duty output.
- The fan speed output is 0-10 volts DC.

Submittal sheets for several variations of this application are available from the [BAC-8000 series](#) page at [KMCControls.com](#).

Illustration 6-4 Time proportional reheat

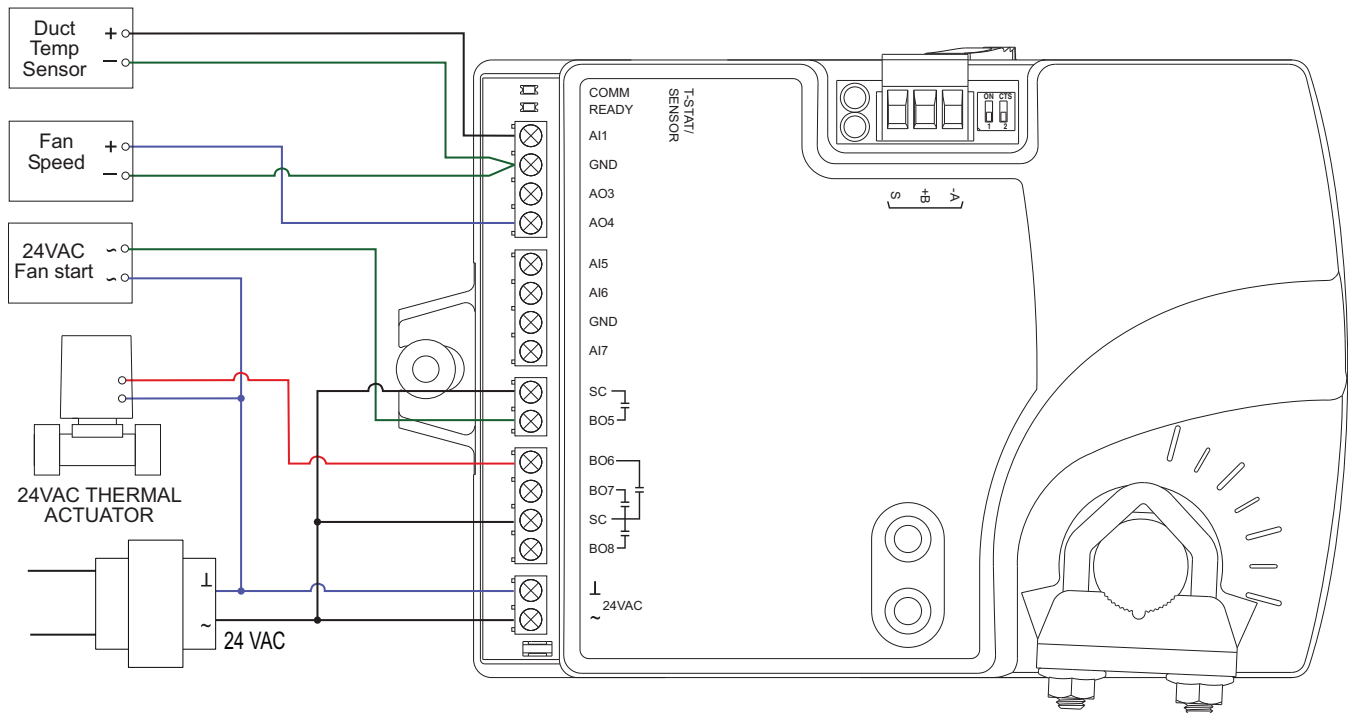

Floating reheat

The floating reheat application is for BAC-8005 or BAC-8205 controllers. Use this application in hydronic systems that are controlled by an actuator with tri-state inputs. The reheat outputs are triacs that can switch up to 1 ampere at 24 volts AC.

For cooling and heating, a duct temperature sensor is required for Discharge Air Temperature limiting and automatic changeover. See the topic [Advanced options on page 33](#) for instructions to enable Discharge Air Temperature limiting.

When connecting the controller to a fan powered VAV unit, the fan circuits must be compatible with the following specifications.

- The fan start circuit is a 24 volt AC pilot duty output.
- The fan speed output is 0-10 volts DC.

Submittal sheets for several variations of this application are available from the [BAC-8000 series](#) page at [KMCControls.com](#).

Illustration 6-5 Floating reheat

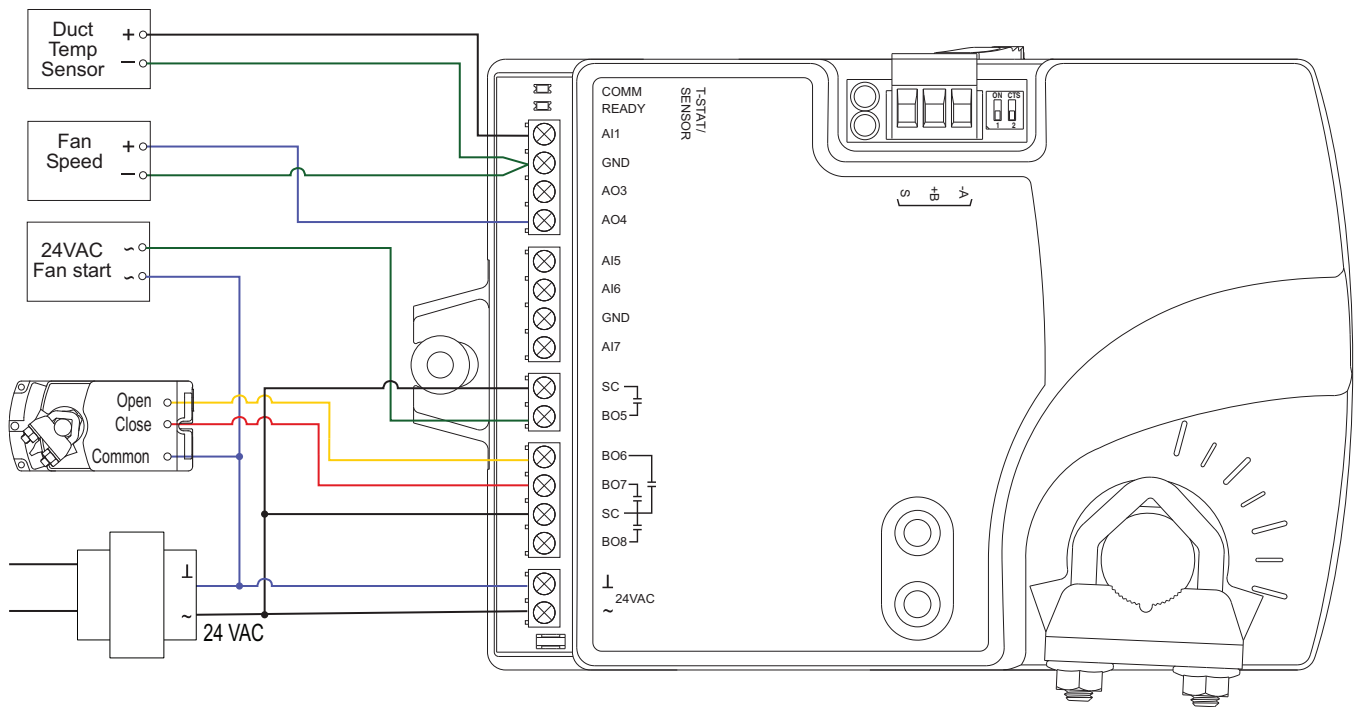

Dual-duct application

The dual-duct application is for a BAC-8007 controller. Dual-duct VAV requires a TSP-8001 actuator to be used with the BC-8007 as shown in the illustration [Dual-duct wiring diagram](#) on page 47.

Submittal sheets for several variations of this application are available from the [BAC-8000 series](#) page at [KMCCcontrols.com](#).

Illustration 6-6 Dual-duct wiring diagram

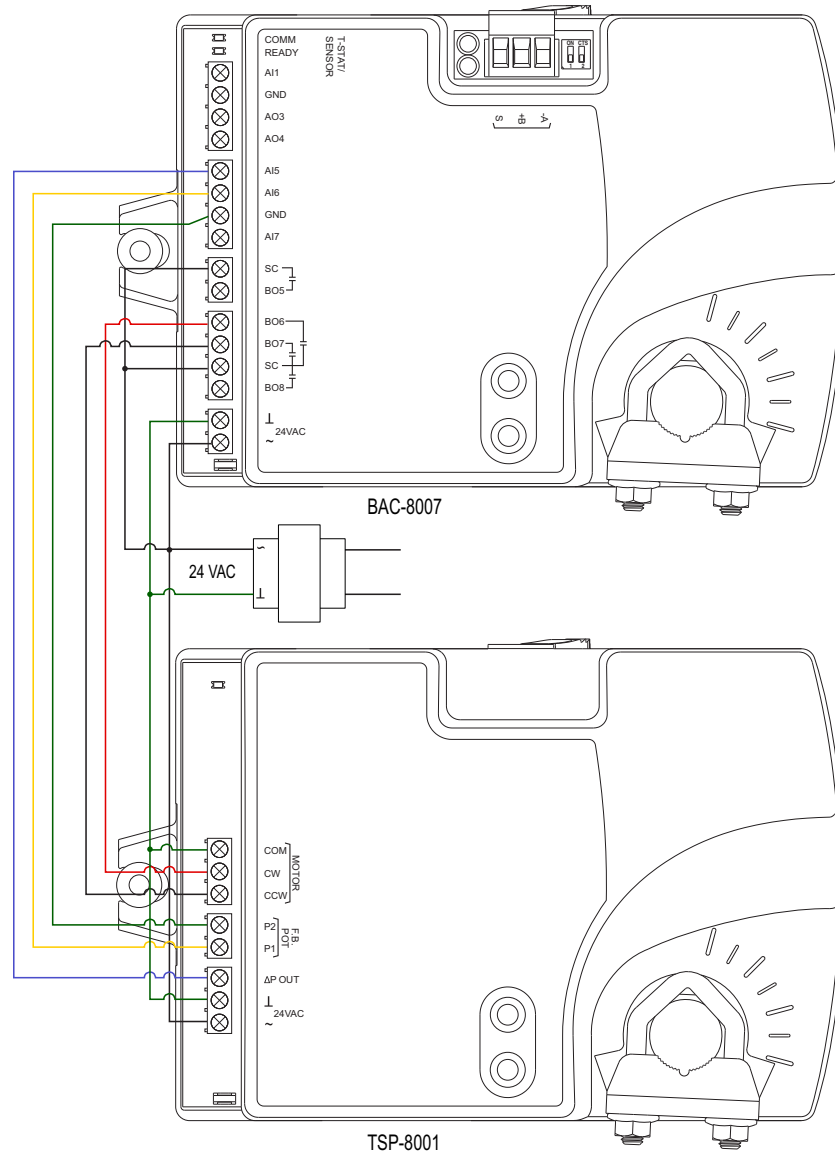

Section 7: Sequences of operation

Topics in this section cover the sequences of operation for the SimplyVAV controllers. These are advanced topics for control technicians and engineers.

These sequences of operation are descriptions of each major component of the SimplyVAV programming. They are provided as an aid to understanding on how the controllers operate.

This section covers the following sequences of operation.

Input sources	49
Occupancy sequence	50
Space setpoints	51
PID control loops	52
Airflow setpoints sequence	53
Changeover	53
Discharge Air Temperature (DAT) limiting	53
System diagnostic indicators	54
Damper operation	55
Fan operation	56
Reheat sequence	57
Balancing airflow sequence	60
Dual duct	61

Input sources

The SimplyVAV controllers require specific sensors to measure room temperature, airflow, and discharge air temperature. All sensors are automatically detected and the programming is automatically set up for the sensors.

- SimplyVAV digital wall sensors
- STE-6000 series discreet temperature sensors
- Discharge air temperature sensor
- Airflow sensors and pickups

SimplyVAV digital wall sensors—The SimplyVAV digital wall sensors include a room temperature sensor, a digital display, and a push button interface for entering setpoints and configuring the controllers. If a SimplyVAV digital wall sensor is detected, the sensor's temperature is mapped to the Space Temperature Reference value object as the temperature input value. See the topic [BACnet objects on page 67](#) for additional information on value objects.

The SimplyVAV digital wall sensor model BAC-8201 includes also a motion sensor to detect when the zone is temporary unoccupied. This is described in the topic [Occupancy sequence on page 50](#).

STE-6000 series discreet temperature sensors—There are three models of the STE-6000 series sensors compatible with the SimplyVAV controllers. If one of the three sensors is detected, the sensor's temperature is mapped to the Space Temperature Reference value object as the temperature input value. See the topic [BACnet objects on page 67](#) for additional information on value objects.

Models STE-6014 and STE-6017 also include a dial for adjusting the setpoint . If either of these two sensors is detected, the dial position sets the Active setpoint a few degrees above or below the Occupied setpoint.

The STE-6017 includes a button that when pushed will override the unoccupied state. This is described in the topic [Occupancy sequence on page 50](#).

Discharge air temperature sensor—The DAT sensor is an optional Type-III, 10 kΩ thermistor and is required for VAV heating applications. If the controller detects that this sensor is connected, then the controller will use discharge air temperature to determine when to change between heating and cooling. The DAT sensor input is used also to control reheat. See the topics [Discharge Air Temperature \(DAT\) limiting on page 53](#) and [Changeover on page 53](#).

Airflow sensors and pickups—VAV airflow is calculated by measuring the high and low duct pressures with the built-in airflow sensor which is connected to airflow pickup tubes. The high and low pressure measurements along with the K-factor of the VAV terminal unit are used to calculate the airflow through the VAV unit.

Occupancy sequence

A SimplyVAV controller is designed to operate as a stand-alone controller and determine occupancy based only on the availability of primary airflow and motion in the zone. The controller can be in any one of the following occupancy states.

- [Occupied on page 50](#)
- [Unoccupied](#)
- [Standby](#)

Occupancy can also be commanded by another BACnet device or an operator workstation connected the building automation network. See the topic [System integration and networking on page 63](#) for details.

Automatic occupancy

If Automatic Occupancy is enabled, the controller will automatically toggle between *Unoccupied*, *Occupied*, and *Standby* based on the presence of primary airflow and motion in the zone.

The default for Automatic Occupancy is *Disabled*. See the topic [Advanced options on page 33](#) to change Automatic Occupancy.

Occupied

For controllers without a connected motion sensor, the controller changes to *Occupied* upon the detection of primary airflow.

Controllers with a connected motion sensor change to *Occupied* upon the detection of primary airflow and motion in the space. The unit will remain in the *OCCUPIED* state as long as periodic motion is detected and primary airflow continues. If motion stops, the controller changes to *STANDBY*.

Unoccupied

The controller Occupancy mode changes to *UNOCCUPIED* when it detects a loss of primary airflow. While in the *UNOCCUPIED* state, the controller will fully open the damper in an attempt to reach the maximum airflow setpoint.

Loss of primary airflow is defined as less than 25% of the requested flow for at least 5 minutes. The Occupancy mode changes to *Occupied* or *Standby* once the actual airflow is at least 30% of the requested flow.

Standby

In units with a connected motion sensor, the controller starts in *STANDBY* and changes to *OCCUPIED* after detecting motion in the space. Motion in the space is defined as two movements detected within 5 minutes. The controller will change back to *STANDBY* after a lack of motion for the period specified by the variable Standby Time.

Standby mode is not valid for controllers without a motion sensor, unless commanded by a building management system.

Space setpoints

There are four temperature setpoints each for heating and cooling for a total of eight setpoints.

- Active cooling
- Occupied cooling
- Unoccupied cooling
- Standby cooling
- Active heating
- Occupied heating
- Unoccupied heating
- Standby heating

Types of setpoints

The SimplyVAV controllers may use any of the following setpoints based on a user entered setpoint or the state of occupancy and standby which is described in the topic [Occupancy sequence on page 50](#).

Active setpoint—The active setpoint is the current setpoint. The active setpoint is determined by the following.

- If the space is occupied, the controller uses the occupied setpoint as the active setpoint.
- If an STE-6014 and STE-6017 is connected, the Active setpoint is set by the dial to be a few degrees above or below the Occupied setpoint. The range of adjustment is set by the variable STBY OFFSET. The dial setting does not change the setpoint when in the Unoccupied or Standby state.
- If the space is unoccupied the controller uses the unoccupied setpoint as the active setpoint.
- If controller is in standby, the controller calculates the standby setpoint.
- A user with Password 1 can enter an active setpoint from a SimplyVAV digital wall sensor. This entry will change the occupied setpoint within the setpoint limits.

Occupied setpoint—A temperature setpoint entered by the controls technician during controller setup and system commissioning. This is the setpoint used when the controller is occupied which is determined by primary airflow and, on controllers equipped with motion sensors, motion in the zone.

Unoccupied setpoint—A temperature setpoint entered by the controls technician during controller setup and system commissioning. This is the setpoint used when the system is unoccupied .

Standby setpoint—The standby setpoint is used when the controller is in the standby state. It is a value calculated from the occupied setpoint and the variable STBY OFFSET. The standby offset value is entered by the controls technician during controller setup and system commissioning. See the topic [Occupancy sequence on page 50](#).

Setpoint limits

The programming in the controller limits the setpoint entry so that no heating setpoint is set higher than its corresponding cooling setpoint.

If a user is adjusting a setpoint and it falls within the range set by the value of Minimum Setpoint Differential, the corresponding setpoint will be changed to maintain the differential. For example, the Minimum Setpoint Differential is 4° F and the Occupied Heating setpoint is 70° F. If the user lowers the Occupied Cooling setpoint to 71° F, the controller recalculates the Occupied Heating setpoint and changes it to 67° F.

PID control loops

A PID control loop calculates an error value from the difference between the measured room temperature and the active setpoint. The error value is expressed as a percentage and is typically used in a BAS controller to control the state of an output. When the difference between the setpoint and room temperature is large, the error is large. As the system reduces the difference between the setpoint and space temperature, the error becomes smaller.

The SimplyVAV controllers use up to three PID loops.

- The heating PID loop.
- The cooling PID loop.
- The discharge air temperature (DAT) loop.

For SimplyVAV controllers, the output of either the cooling and heating PID loop is used to calculate the position of the damper. If present, the DAT input and DAT loop controls the Reheat loop.

The PID loops in the SimplyVAV controllers are standard BACnet objects and are described in the topic [BACnet objects on page 67](#).

Airflow setpoints sequence

Airflow Setpoint is calculated based on the demand for cooling or heating depending on whether the Cooling loop or Heating loop is greater than zero.

If no room sensor is connected to the controller, the controller uses the Minimum Cooling Airflow setpoint to maintain airflow.

Cool Air Sequence

As the Cooling loop increases from 0% to 100%, Primary Airflow Setpoint is proportionally calculated between Minimum Cooling Airflow and Maximum Cooling Airflow.

If there is a call for reheat to maintain room temperature, the primary airflow is set to the value of Auxiliary Flow.

Warm Air Available

In the heating mode, as the Heating Loop increases from 0% to 100%, Primary Airflow Setpoint is proportionally calculated between Minimum Heating Airflow and Maximum Heating Airflow.

See also the topics, [Changeover on page 53](#) and [Input sources on page 49](#).

Changeover

The Discharge Air Temperature input is used by the controller to determine the type of air that is being supplied by the AHU. The sensor is required for applications that require automatic change over between cooling and heating.

When the Heating loop is inactive, the Discharge Air Temperature input is compared to the SAT Changeover Temp. If the Discharge Air Temperature is below the SAT Changeover Temp minus 2°, the SAT Changeover Mode is set to *COOL*. If the Discharge Air Temperature is above the SAT Changeover Temp plus 2° Fahrenheit, the SAT Changeover Mode is set to *HEAT*. The default changeover temperature is 74° Fahrenheit.

See the topic [Discharge Air Temperature \(DAT\) limiting on page 53](#) and [Input sources on page 49](#).

Discharge Air Temperature (DAT) limiting

A Discharge Air Temperature sensor and DAT limiting is required to control VAV units with reheat. If a Discharge Air Temperature (DAT) sensor is detected and DAT Limiting is

enabled, the VAV terminal will be controlled by the DAT loop. The unit will also limit the Discharge Air Temperature to within 15° F of the Space Temp Reference.

When there is a call for heat and the primary air is cool air, the reheat outputs are directly controlled by the DAT Loop and the DAT Setpoint reset based on the output of the Heating loop. As the Heating loop increases from 0% to 50%, DAT Setpoint is proportionally calculated between Space Temp Reference and Space Temp Reference + 15° F up to maximum 90° F. This allows the reheat to be controlled by the DAT loop over the first 50% of a call for heating.

Illustration 7-1 DAT limiting operation

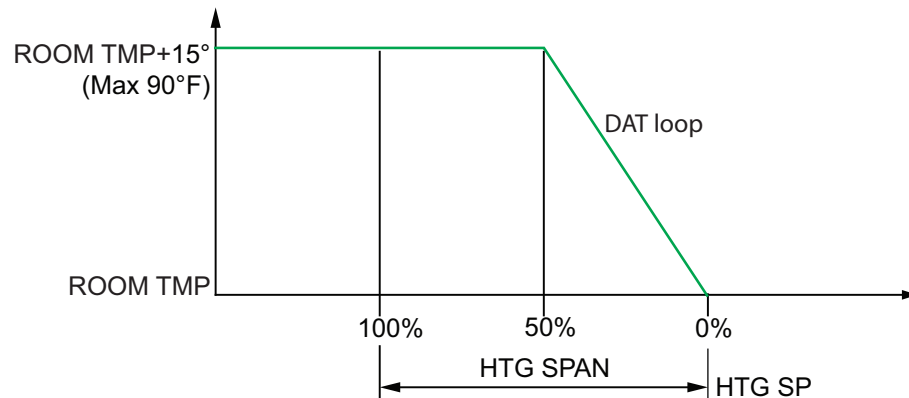

If DAT Limiting is enabled, and a DAT sensor is not connected, the controller will lockout reheat control only in the cooling mode. The unit will operate this way until a DAT sensor is detected or until the unit is commanded to control to the Active Heating Setpoint by a supervisory BMS.

If the unit has detected a DAT sensor and DAT Limiting is not enabled, the unit's reheat is controlled by the Heating loop instead of the DAT loop.

See also the topics [Changeover on page 53](#) and [Input sources on page 49](#).

System diagnostic indicators

The controller programming includes four system diagnostic indicators in the form of BACnet value objects.

- [NEED AHU \(BV1\)](#)
- [NEED COLDER SUPPLY \(BV2\)](#)
- [NEED MORE STATIC \(BV3\)](#)
- [NEED HOTTER SUPPLY \(BV7\)](#)

These diagnostic indicators or flags are monitored by other BACnet devices, such as air handling units, connected to the same building automation system as the controller. How the indicators are used is beyond the scope of these instructions.

NEED AHU (BV1)

The Need AHU Start value object is set to *TRUE (1)* for any of the following conditions.

- The system mode is *UNOCCUPIED* and the Cooling loop or the Heating loop is greater than 100% for longer than 10 minutes.
- The system mode is *OCCUPIED* or *STANDBY*.
- Either of the Motion Override or Local Override variable objects are *TRUE (1)*.

The Need for AHU Start object changes to *FALSE (0)* when both loops drop below 5% and the system mod is not *OCCUPIED* or *STANDBY* and both override variable objects are *FALSE (0)*.

NEED COLDER SUPPLY (BV2)

The Need Colder Supply value object is set to *TRUE (1)* when the system mode is *STANDBY* or *OCCUPIED* and the Cooling loop is greater than 95% for 30 minutes. The indicator changes to *FALSE (0)* when the Cooling loop falls below 90% or when the system mode is *UNOCCUPIED*.

NEED MORE STATIC (BV3)

The Need More Static value object is set to *TRUE (1)* when the controller has attempted to drive the damper fully open for longer than 2 minutes 30 seconds and any of the following are *TRUE (1)*.

- The system mode is *OCCUPIED* or *STANDBY*.
- Either of the Motion Override or Local Override variable objects are *TRUE (1)*.

When any of these conditions are no longer true, the indicator changes to *FALSE (0)*.

NEED HOTTER SUPPLY (BV7)

The Need Warmer Supply value object is set to *TRUE (1)* when the system mode is *STANDBY* or *OCCUPIED* and the Heating loop is greater than 95% for 30 minutes. The indicator changes to *FALSE (0)* when the Heating loop falls below 90% or when the system mode is no longer *OCCUPIED*.

Damper operation

Damper movement is determined by comparing the actual airflow reading to the airflow setpoints. If the actual airflow is within 5% of the setpoint, no damper action is initiated. Once within the 5% deadband, the actual airflow must be outside a 7% deadband before damper position changes.

To improve stability near setpoint, the damper motor is pulsed when the actual flow rate is within 15% of the requested flow rate. The pulse rate is 5 seconds and the duty cycle is controlled by analog variable MOTOR PAUSE. In addition, the motor will pause for 10 seconds before the damper changes direction.

Fan operation

The SimplyVAV controllers support both series and parallel fan powered VAV units. For either type of fan operation, the fan is controlled through the following terminals.

- A binary output triac controls a 24-volt fan starting circuit. See the topic [Configuring the VAV Box options on page 27](#) for the procedure to configure the controller for a fan.
- A 0-10 volt DC analog output controls the speed of the fan. The output controls fan speed at either Min Fan Speed or Max Fan Speed. See the topic [Set the airflow setpoints on page 29](#) for the procedure to set the fan speeds.

If the VAV unit is not configured for a fan, the two outputs are not used and remain inactive regardless of the occupancy state.

Series Fan

If the controller is configured for a series fan, any time the Occupancy mode of the controller is set to either *OCCUPIED* or *STANDBY*, the fan runs continuously. The fan speed is set to Maximum Fan Speed when the state is *OCCUPIED* and set to Minimum Fan Speed when the state is *STANDBY*.

When the Occupancy state is *UNOCCUPIED*, the fan starts and runs at minimum speed only on a call for heating. The fan starts when the Heating loop is greater than 5% and stops when the Heating loop is less than 1%.

Illustration 7-2 Series fan operation

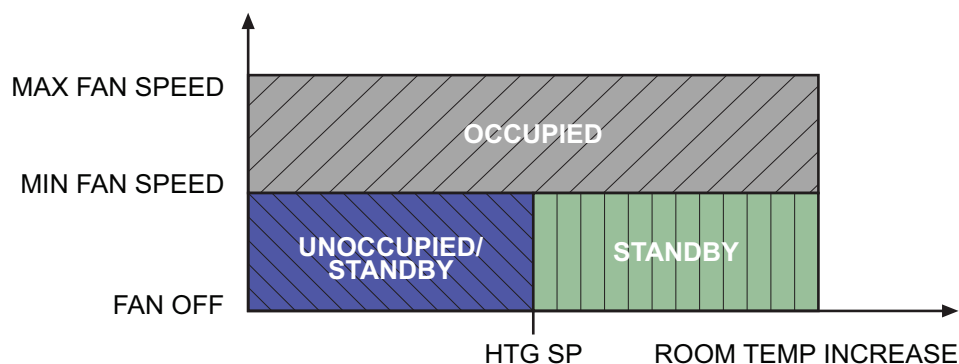

Parallel Fan

If the controller is configured for a parallel fan, any time the Occupancy mode of the controller is set to either *OCCUPIED* or *STANDBY* and there is a call for heat, the fan runs continuously. The fan starts when the Heating loop is greater than 5% and stops when the Heating loop is less than 1%.

When the unit Occupancy state is *UNOCCUPIED*, the fan starts and runs at minimum speed only on a call for heating. The fan starts when the Heating loop is greater than 5% and stops when the Heating loop is less than 1%.

Illustration 7-3 Parallel fan operation

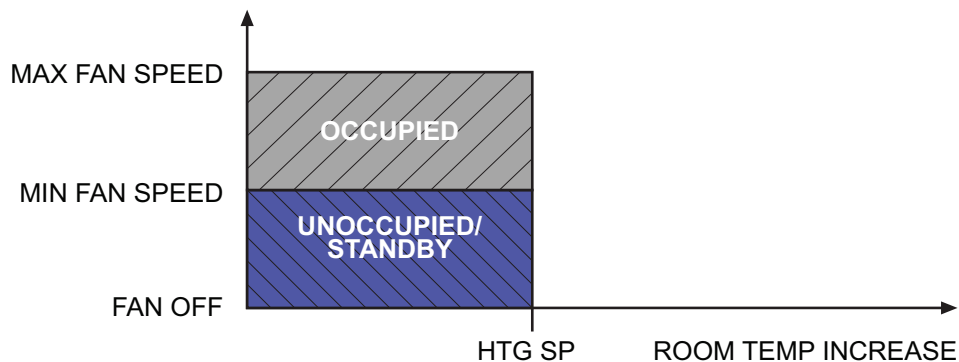

Reheat sequence

The SimplyVAV controllers can control four types of reheat installations.

- *Modulating reheat*
- *Staged reheat*
- *Time proportioned reheat*
- *Floating reheat*

All reheat is controlled by either the Heating loop or the Discharge Air Temp Limiting (DAT) PID loop. Loops are described in the topic [PID control loops on page 52](#).

- If Discharge Air Temp Limiting is enabled, reheat is controlled by the DAT PID loop.
- If DAT control is not enabled, reheat is controlled by the Heating loop.

In the following descriptions, the loop controlling reheat is referred to as the Reheat loop.

Modulating reheat

If the controller is configured for modulating reheat, it controls an analog reheat unit with 0-10 volts DC at the analog reheat output. On a call for reheat, the reheat output is modulated over the span of the Reheat loop. If the Reheat loop is less than 10%, the reheat output remains at zero. The reheat is set to zero if the Cooling loop is active.

See the topic [Modulating reheat on page 44](#) for an application drawing.

Illustration 7-4 Modulating reheat operation

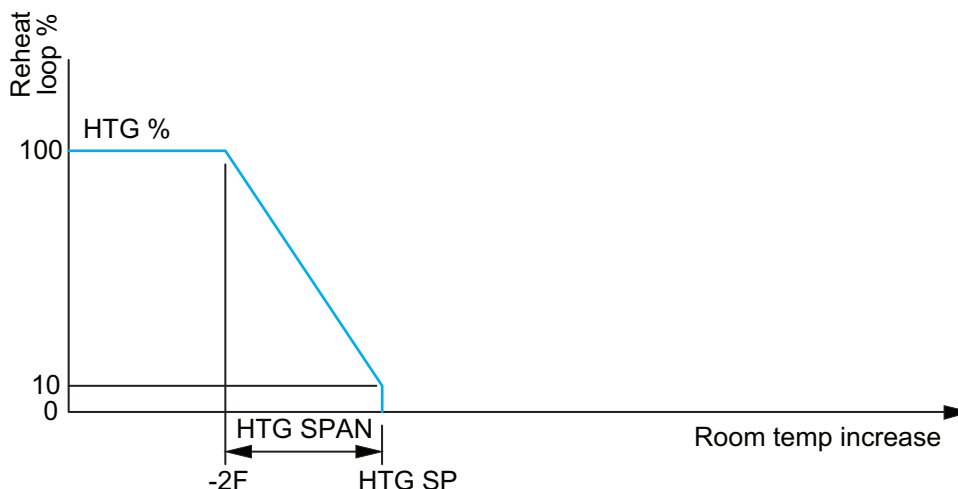

Staged reheat

If the controller is configured for staged reheat, it can control up to three stages of reheat through binary triac outputs. The reheat outputs are commanded *On* when the Reheat loop rises above the *ON* threshold and *Off* when the loop drops below the *OFF* threshold. Thresholds are described in the following chart, [Staged reheat thresholds on page 58](#).

See the topic [Staged reheat on page 43](#) for an application drawing.

Table 7-1 Staged reheat thresholds

Heating stages	Output state	
	On threshold	Off threshold
Stage 1	35%	15%
Stage 2	65%	45%
Stage 3	95%	75%

Time proportioned reheat

For controllers configured for time proportional reheat, the duty cycle of a binary triac output varies over a 10 second period. For example, if the Reheat loop is at 50%, the reheat output is ON for 5 seconds and OFF for 5 seconds. If the Reheat loop is less than 10%, the reheat output remains at zero.

See the topic [Time proportional reheat on page 45](#) for an application drawing.

Illustration 7-5 Time proportional reheat operation

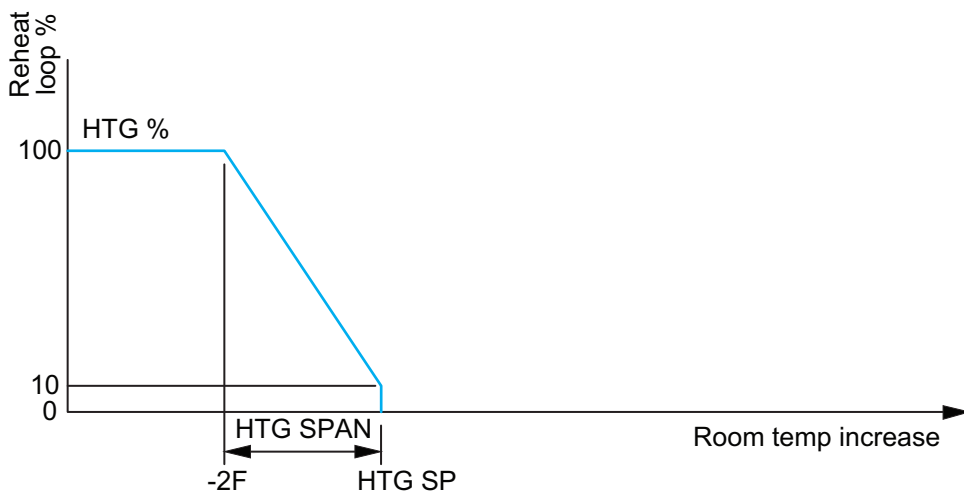

Floating reheat

If the controller is configured for floating reheat, it controls two binary triac outputs to drive the inputs of a tri-state actuator connected to a valve. If the Reheat loop is less than 30%, the valve is driven closed. If the loop is greater than 70%, the valve is driven open. If the loop is in between 30% and 70%, no valve action is taken.

See the topic [Floating reheat on page 46](#) for an application drawing.

Illustration 7-6 Floating reheat operation

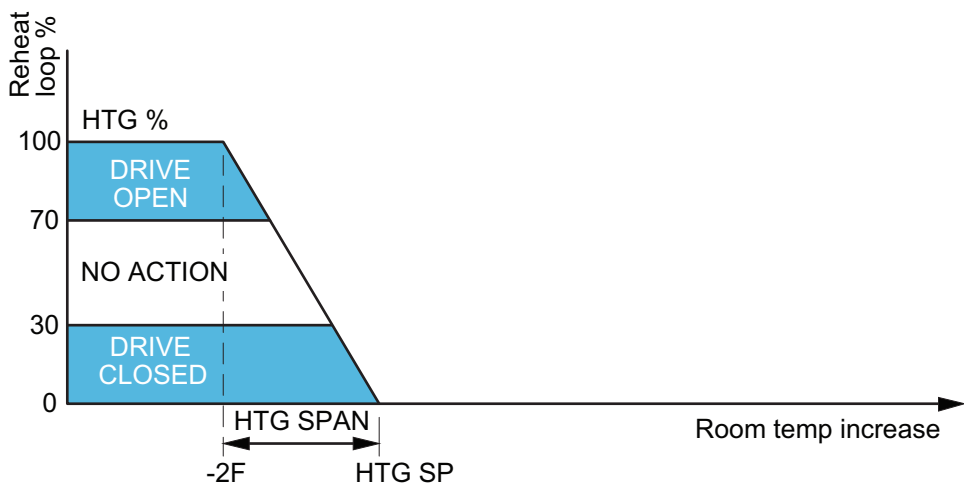

Balancing airflow sequence

Balancing airflow is the process of calibrating the internal airflow sensor to a known standard. In the field, airflow is measured with an airflow hood or other measuring instrument and then compared to the airflow measurements from the sensor in the controller. The balancing process requires an STE-8001 or STE-8201 digital sensor as the technicians setup tool for initiating the balancing sequence and entering actual flow measurements.

When the balancing sequence starts, all other functions of the controller are locked out.

At the start of the sequence, the controller drives the damper open until the airflow reaches the highest value of either the cooling or heating maximum airflow setpoints. An airflow measurement is made with an airflow hood and the actual airflow value is entered into the controller. Once the actual airflow is entered, the controller drives the damper closed to the lower value of either the cooling or heating minimum airflow. Another measurement is made with the flow hood and that measurement is entered into the controller.

After the minimum airflow measurement is entered, the programming in the controller calculates airflow correction factors which are used to adjust measurements from the internal airflow sensor. Balancing is complete and the controller is returned to normal operation.

See the topic [Balancing airflow on page 37](#) for the procedure to balance the airflow with a digital sensor.

Dual duct

A dual duct installation consists of separate primary heating and cooling ducts, both with control dampers and airflow monitoring. For this type of installation a SimplyVAV BAC-8007 controls the cooling air (primary) damper and a TSP-8001 actuator controls the heating air (secondary) damper.

- As the space temperature rises above the cooling setpoint, the primary airflow is modulated from the Cooling Minimum flow to the Cooling Maximum Flow.
- As the space temperature falls below the heating setpoint, the secondary airflow is modulated from the Heating Minimum flow to the Heating Maximum Flow.
- Between the heating and cooling setpoints, both the primary airflow and secondary airflow are modulated to maintain the Dual Duct Minimum airflow.

See the topic, [Dual-duct application on page 47](#) for an application drawing.

Illustration 7-7 Dual duct sequence

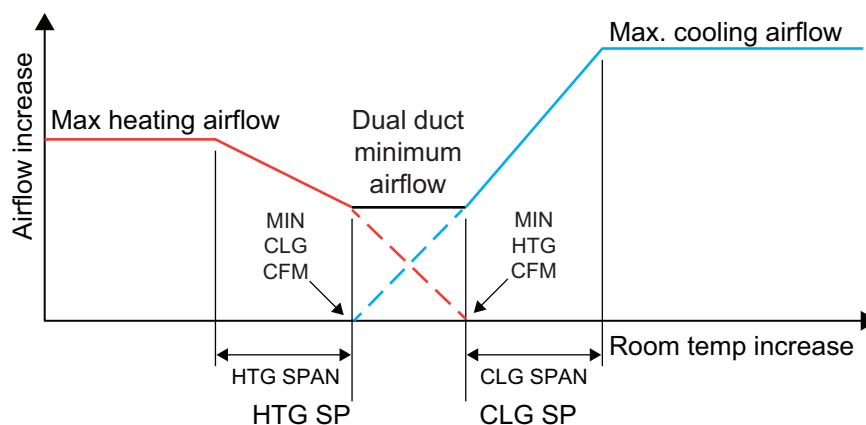

Section 8: System integration and networking

Topics in this section cover integrating the controllers into a building automation network. These are advanced reference topics for control technicians and engineers.

The controllers can be installed as standalone controllers or they can be connected to a BACnet MS/TP network. The topics in this section are reference material for control technicians or engineers who are planning, installing, and setting up controllers that are connected to a network.

In addition to the information in this section, you will also need the following information.

- Detailed plans and drawings for the building automation system.
- Information about the facility LAN including routers, switches, and network firewalls.
- Sequences of operation for other BACnet devices that will monitor or interact with SimplyVAV controllers.

Integration topics

Connecting to an MS/TP network	63
Setting up network communications	65
BACnet objects	67

Connecting to an MS/TP network

SimplyVAV controllers are BACnet MS/TP compliant controllers. Connect them only to a BACnet MS/TP network.

To enter the BACnet device instance, MAC address, and network baud, see the topic [Setting up network communications on page 65](#).

Illustration 8-1 MS/TP network wiring and EOL switches

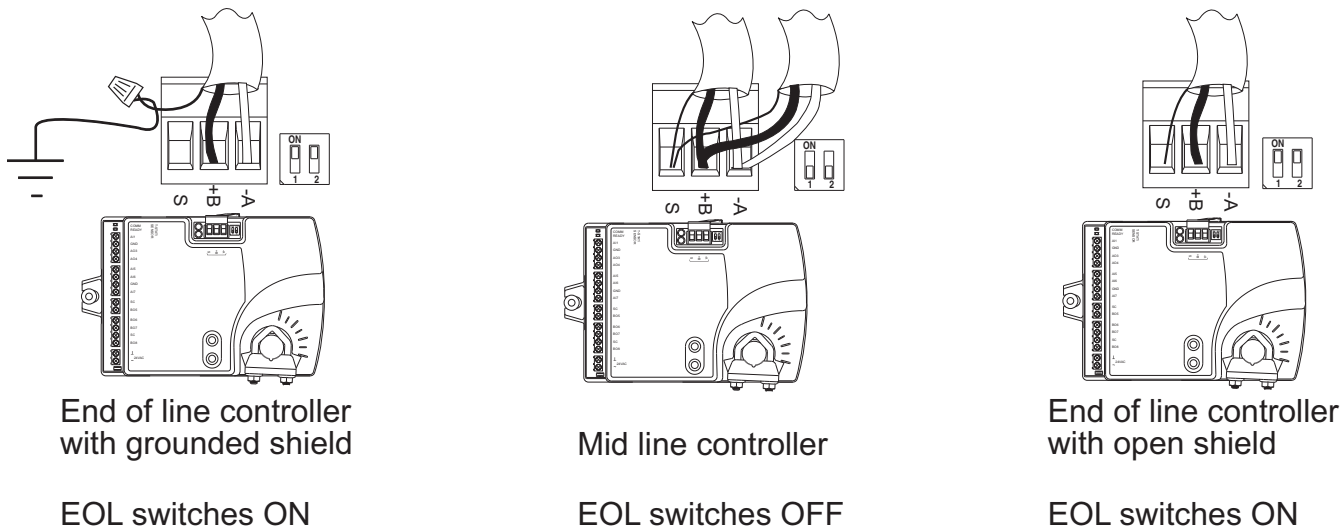

Connections and wiring

Use the following principles when connecting a controller to an MS/TP network:

- Connect no more than 128 addressable BACnet devices to one MS/TP network. The devices can be any mix of controllers or routers.
- For best network performance, limit the MS/TP network size to 32 controllers.
- Use twisted pair, shielded cable with capacitance of no more than 51 picofarads per foot for all network wiring. Belden cable model #82760 meets the cable requirements.
- Connect the -A terminal in parallel with all other - terminals.
- Connect the +B terminal in parallel with all other + terminals.
- Connect the shields of the cable together at each mid line controller. For SimplyVAV controllers use the S terminal.
- Connect the shield to an earth ground at one end only.
- Use a KMD-5575 repeater if the cable length will exceed 4000 feet (1220 meters). Use no more than four repeaters per MS/TP network.
- Place a KMD-5567 surge suppressor in the cable where it exits a building.

End of line termination switches

The controllers on the physical ends of the EIA-485 wiring segment must have end of line termination added for proper network operation.

- For controllers at the end of the network set the EOL switches to *On*
- For mid line controllers at the end of the network set the EOL switches to *Off*

Network bulbs

SimplyVAV controllers include network bulbs located near the MS/TP network connector. These bulbs serve three functions:

- Removing both bulbs will disconnect the controller from the MS/TP network.
- If one or both bulbs are lit, it indicates the network connection or controller power is not properly wired.
- If the voltage or current on the network exceeds safe levels, the bulbs may open and protect the controller from damage.

Bulbs are illuminated If one or both bulbs are illuminated, it indicates the network is not phased correctly. The ground potential of the controller is not the same as other controllers on the network. The brighter the isolation bulbs on a controller are illuminated, the closer that controller is to the source of the problem. Remove power and check the network and power connections.







Bulbs are open If one or both bulbs are open—as tested with an ohm meter—it indicates the voltage or current on the network exceeded safe levels. Correct the conditions and replace the bulbs.

Bulbs not inserted correctly One lead from one or both of the bulbs are not inserted into the socket.

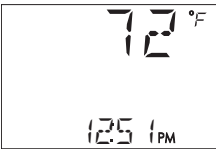

Setting up network communications

Set the network communication settings before placing a controller on the network. Setting network settings requires entering Password 2 which is described in the topic [Getting started with configuration on page 21](#).

Table 8-1 Procedure to set up network communications

Procedure	Detailed steps	Sensor display
1 Starting display	1. Start at the temperature display.	
	2. Press the Δ and ∇ buttons together. <ul style="list-style-type: none"> If Password 2 is not required, the display changes to ENFG. If required, enter Password 2. The display changes to ENFG when Password 2 is correct. 	
2 Select the ENFG display	1. From the ENFG display, press the Δ or ∇ buttons to advance to the COMM display.	
	2. Press the \odot button. The display changes to COMM .	
3 Enter the device instance.	1. Press the Δ or ∇ buttons to change the first digit.	
	2. Press the \odot button to select the next digit. Repeat for all seven digits.	
	3. When the \odot button is pressed for the last digit, the display changes to MAC .	
4 Enter the MAC address.	1. Press the Δ or ∇ buttons to change the MAC address.	
	2. Press the \odot button to save the selected MAC address. The display changes to BAUD .	

Procedure to set up network communications (continued)

Procedure	Detailed steps	Sensor display
5 Enter the baud	<ol style="list-style-type: none"> 1. Press the Δ or ∇ buttons to select a new baud. 2. Press the \ominus button to save the selected baud. The display returns to COMM. 	 <p>The sensor display shows the word "BAUD" in large characters at the top and the number "38400" in smaller characters below it.</p>
6 Advance or exit	<ol style="list-style-type: none"> 1. Press the Δ or ∇ buttons to select one of the following: <ul style="list-style-type: none"> • BLNC or CNFG options • EXIT to return to the temperature display. 2. Press the \ominus button to select the next function. 	 <p>The sensor display shows the word "COMM" in large characters.</p>

BACnet objects

The SimplyVAV controllers are BACnet Application Specific Controller (ASC) that are composed of standard BACnet objects. This section lists the objects that are likely to be monitored by a standard BACnet operator workstation to verify system operation.



Changing the configuration of any object may result in unpredictable operation of a controller and damage to equipment that is under control of a SimplyVAV controller.

Input objects

The following BACnet input objects represent values at the physical inputs of the controller. For wiring details, see the topic [Application drawings on page 41](#).

Table 8-2 Input objects

Input	Name	Description	Object type	Termination
AI1	DISCHARGE AIR	Discharge Air Temperature	KMC 10K Type_III	10K fixed
AI2	SPACE SENSOR	Space Sensor	KMC Type II Deg F	10K fixed
AI3	SETPOINT OFFSET	Setpoint Offset	TABLE 4	10K fixed
AI4	PRIMARY DUCT	Primary Duct Pressure		
AI5	SECONDARY DUCT	Secondary Duct Pressure		

Output objects

The following BACnet output objects represent values at the physical outputs of the controller. For application specific output wiring details, see the topic [Application drawings on page 41](#).

Table 8-3 Output objects

Output	Name	Description	Units
A03	ANALOG HEAT	Analog Heat	0_100%
A04	FAN SPEED	Fan Speed	0_100%
B01	DAMPER CW	Damper Clockwise	
B02	DAMPER CCW	Damper Counter Clockwise	
B05	FAN	Fan	
B06	HT STAGE 1	Heating Stage 1	
B07	HT STAGE 2	Heating Stage 2	
B08	HT STAGE 3	Heating Stage3	

Value objects

BACnet value objects represent setpoints or other operational conditions in the controller.

Note: Not all objects are present in every model.

Table 8-4 Analog value objects

Object	Name	Description
AV1	SPACE TEMP	Space Temperature
AV2	STPT OFFSET	Setpoint Offset
AV3	ACT COOL STPT	Active Cooling Setpoint
AV4	ACT HEAT STPT	Active Heating Setpoint
AV5	OCC CL STPT	Occupied Cooling Setpoint
AV6	OCC HT SPT	Occupied Heating Setpoint
AV7	UNOCC CL STPT	Unoccupied Cooling Setpoint
AV8	UNOCC HT STPT	Unoccupied Heating Setpoint
AV9	MIN CL STPT	Minimum Cooling Setpoint
AV10	MAX HT STPT	Maximum Heating Setpoint
AV11	MIN STPT DIFF	Minimum Setpoint Differential
AV12	STBY OFFSET	Standby Offset
AV13	MIN COOL FLOW	Minimum Cooling Flow
AV14	MAX COOL FLOW	Maximum Cooling Flow
AV15	MIN HEAT FLOW	Minimum Heating Flow
AV16	MAX HEAT FLOW	Maximum Heating Flow
AV17	AUXILIARY FLOW	Auxiliary Flow
AV18	PRI K FACT	Primary K Factor
AV19	PRI CORR SLOPE	Primary Correction Slope
AV20	PRI CORR OFFST	Primary Correction Offset
AV21	PRI LO FLOW CORR	Primary Low Flow Correction
AV22	PRI FLOW STPT	Primary Flow Setpoint
AV23	PRI RAW FLOW	Primary Raw Flow
AV24	PRI ACTUAL FLOW	Primary Actual Flow
AV32	MIN FAN SPEED	Minimum Fan Speed
AV33	MAX FAN SPEED	Maximum Fan Speed

Analog value objects (continued)

Object	Name	Description
AV36	DAT STPT	Discharge Air Temp Setpoint
AV37	SAT CHANGEOVER	SAT Changeover Temperature
AV38	LOCAL OVRD TIME	Local Override Timer
AV39	STANDBY TIME	Standby Timer (motion)
AV40	STANDBY TRIGGER	Standby Trigger
AV43	MEASURED MAX	Measured Maximum
AV44	MEASURED MIN	Measured Minimum
AV45	PRI SAVE MIN FLO	Primary Saved Minimum Airflow
AV47	DAT MAXIMUM	Maximum DAT Setpoint
AV48	CW DMP POS	CW Damper Position
AV49	CCW DMP POS	CCW Damper Position
AV50	DAMPER POSITION	Damper Position
AV51	ApplicationID	
AV54	MOTOR PAUSE	Analog Value #54
AV55	CHNG_OVER_DELAY	Cooling Change Over Delay
AV56	LOW AUTO OCC	Low Limit for Auto Occupy

Table 8-5 Binary value objects

Object	Name	Description
BV1	NEED AHU	Need For AHU
BV2	NEED COLDER SPLY	Need For Colder Air Supply
BV3	NEED MORE STATIC	Need For AHU
BV4	LOCAL OVRD	Local Override Mode
BV5	MOTION OVRD	Motion Override Mode
BV6	MOTION SENSOR	Motion Sensor (Wall Stat)
BV7	NEED HOTTER SPLY	Need For Hotter Air Supply
BV8	CHANGE OVER MODE	SAT Changeover Mode
BV9	DAT LIMITING	Discharge Air Temp Limiting
BV10	CLOCKWISE CLOSE	Clockwise Close
BV11	AUTO OCCUPANCY	Auto Occupancy Detection

Binary value objects (continued)

Object	Name	Description
BV12	BALANCE MODE	Balance Mode
BV13	DAT SENSOR	DAT Sensor Present
BV14	PRI BAL TRIGGER	Primary Balance Trigger

Table 8-6 Multistate value objects

Object	Name	Description
MSV1	OCCUPIED MODE	Occupied Mode
MSV2	FAN CONFIG	Fantype Configuration
MSV3	REHEAT	Reheat Type
MSV6	WALL SENSOR	Multi-state Value #6

Loop objects

BACnet PID loops are used for modulating the damper and controlling reheat.

Table 8-7 PID control loop objects

Loop	Name	Description
LOOP1	CL LOOP	Cooling Loop
LOOP2	HT LOOP	Heating Loop
LOOP3	DAT Loop	Discharge Air Temp Loop

Appendix A: K-factors

To set up a VAV controller, a K-factor must be entered into the controller. Typically, this is part of the airflow chart that the manufacturer places on the VAV unit. If this information is missing and not available from the manufacturer, use the K-factor in the following chart.

Table A-1 Start point K factors

Duct size in inches	K-factor, CFM	K-factor, LPS
4	265	8
5	357	11
6	460	14
7	652	19
8	890	27
9	1145	34
10	1443	43
12	1972	59
14	2771	86
16	3741	111
24 x 16	6980	208

Index

A

- accessories 9
- actuator
 - mounting 14
 - rotation limits 13
 - shaft size 6
 - specifications 6
 - speed 6
- airflow
 - balancing 37
 - maximum limit 29
 - minimum limit 29
 - sensor 15
 - setting limits 29
- applications 41
 - cooling only without reheat 42
 - cooling/heating without reheat 42
 - dual duct 47
 - floating reheat 46
 - modulating reheat 44
 - staged reheat 43
 - three-stage reheat 43
 - time proportional reheat 45
- automatic occupancy
 - enabling 33
 - sequence 50
- auxillary flow
 - sequence 53
 - setting 29

B

- BAC-8001
 - cooling only 42
 - cooling/heating 42
- BAC-8005
 - modulating reheat 44-46
 - staged reheat 43
- BAC-8007, dual-duct 47
- BACnet objects 67
 - input 67
 - loops 70
 - outputs 67
 - PID loop sequence 52
 - value 68
- balancing
 - procedure 37
 - sequence 60
- baud 65

bulbs

- network 63
- replacement 9

C

- calibration
 - airflow 37
 - sensors 33
- Celsius display 35
- changeover sequence 53
- configuration 21
- connecting
 - airflow sensor 15
 - DAT sensor 16
 - input devices 15
 - output devices 15
 - sensors 15

D

- damper
 - sequence 55
 - setting direction to close 27
- device instance 65
- diagnostic indicators 54
- discharge air temperature
 - enabling 33
 - sensor connection 16
- display units 35
- dual duct
 - application drawing 47
 - sequence 61

E

- end-of-line switches 63
- end stops 13
- English display 35

F

- Fahrenheit display 35
- fans
 - configuration 27
 - parallel sequence 56
 - series sequence 56
 - setting speed 29
 - speed sequence 56
 - with floating reheat 46
 - with modulating reheat 44
 - with staged reheat 43
 - with time proportional reheat 45
- floating reheat 46

I

- inputs
 - as BACnet objects 67
 - connecting 15
 - DAT sensor 16
 - room sensors 15
 - specifications 6
- installing the controller 13

K

- K-factor
 - setting 27
 - unknown 71

M

- MAC address 65
- maintenance 18
- Metric display 35
- models 10
- modulating reheat 44
- motion sensing sequence 50
- mounting 14
- MS/TP wiring 63

N

- network
 - address 65
 - baud 65
 - bulbs 63
 - termination 63
 - wiring 63

O

- occupied
 - sequence 50
 - temperature setpoints 23
- outputs
 - as BACnet objects 67
 - connecting 15
 - specifications 6
- override
 - sequence 49
 - setting time 33

P

- parallel fan
 - configuration 27
 - sequence 56
- passwords
 - changing and establishing 33
 - Password 1 19

- Password 2 21
- PID loops
 - as BACnet objects 70
 - sequence of operation 52

R

- reheat
 - configuration 27
 - floating 46
 - modulating 44
 - sequences of operation 57
 - staged 43
 - three-stage 43
 - time proportional 45
 - two-stage 43
- replacement parts 9
- restore application 35
- rotation limits 13

S

- sensors
 - airflow 15
 - calibration 33
 - compatible 9
 - connecting 15
 - DAT sensor 16
 - room sensors 15
 - sequence 49
- sequences of operation 49
 - airflow setpoints 53
 - balancing 60
 - changeover 53
 - damper 55
 - DAT limiting 53
 - dual duct 61
 - fans 56
 - input sources 49
 - motion detection 50
 - occupancy 50
 - PID loops 52
 - sensors 49
 - setpoints 51
 - standby 50
 - system diagnostics 54
 - unoccupied 50
- series fan 56
 - configuration 27
 - sequence 56
- setpoints
 - limits sequence 51
 - room temperature sequence 51
 - sequence 51

setting

changeover 23

limits 23

occupied 23

room 19

standby 23

shaft size for actuator 6

specifications 6

standby

sequence 50

setting timer 33

submittal sheets 41

system diagnostic indicators 54

T

three-stage reheat 43

time proportional reheat 45

timers, setting 33

transformer wiring 17

tri-state reheat 46

two-stage reheat 43

U

units to display 35

unoccupied

sequence 50

temperature setpoints 23

V

value objects 68

W

wiring

application drawings 41

connecting power 17

DAT sensor 16

MS/TP network 63

room sensors 15