

Features

- Single handle controls flow to outlets
- ADA-compliant ergonomic handle
- Coordinates with other products in the Riff collection
- Trim only; requires K-728-K two- or three-way transfer valve, or K-737-K two- or three-way diverter valve (sold separately)

Material

- Premium material construction with metal handle ensures reliability and durability
- KOHLER finishes resist corrosion and tarnishing

Installation

- Patented K-joint installation technology ensures consistent trim appearance, regardless of variability in valve rough-in
- Wall-mount
- Trim only; requires valve to complete installation (sold separately)

Required Products/Accessories

K-737-K 3/4" Two- or Three-Way Diverter Valve

or

K-728-K 3/4" two- or three-way transfer valve

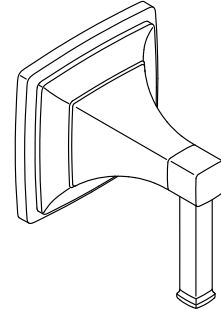

Codes/Standards





ASME A112.18.1/CSA B125.1
ADA
ICC/ANSI A117.1
CSA B651
OBC

KOHLER® Faucet Lifetime Limited Warranty

See website for detailed warranty information.

Available Colors/Finishes

Color tiles intended for reference only.

Color	Code	Description
	CP	Polished Chrome
	SN	Vibrant® Polished Nickel
	BN	Vibrant® Brushed Nickel
	BL	Matte Black
	2MB	Vibrant® Brushed Moderne Brass

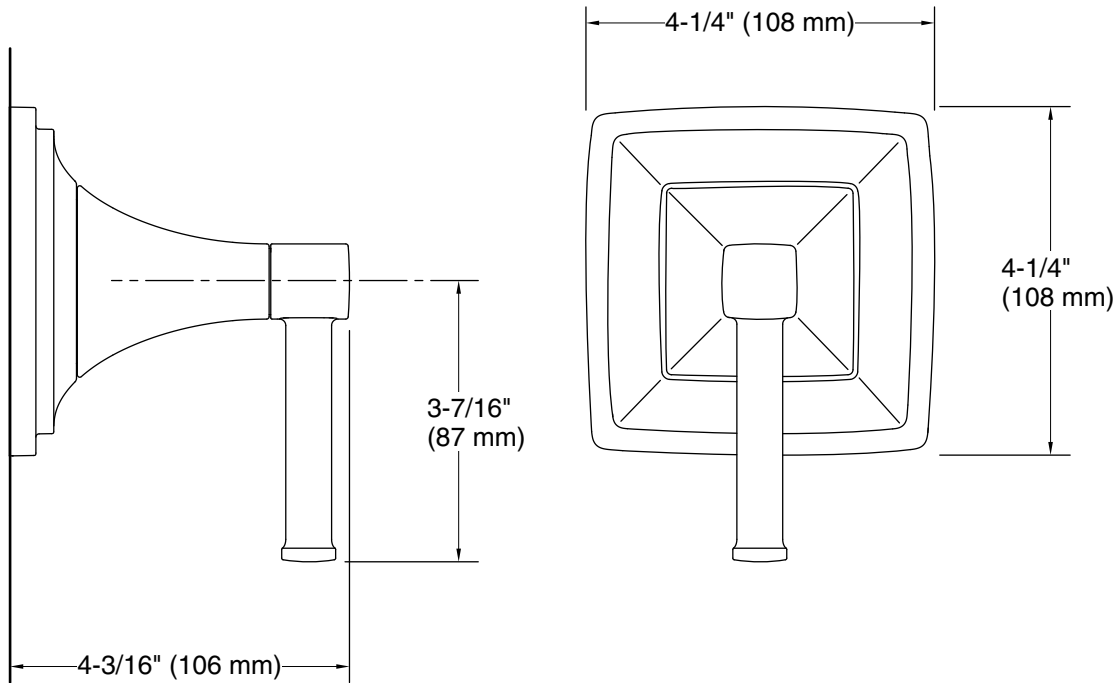

Technical Information

All product dimensions are nominal.

Spout:

Notes

ADA, OBC, CSA B651 compliant when installed to the specific requirements of these regulations.