

Features

- Includes faceplate with handle, bath spout, shower arm and flange
- A single handle controls both on/off activation and temperature setting
- Cross handle
- Integrated push-button diverter
- Includes nondiverter bath spout with 1/2" NPT connection
- For use with any KOHLER showerhead (sold separately)
- Complements Purist faucets and accessories

Material

- Premium material construction with metal handle ensures reliability and durability
- KOHLER finishes resist corrosion and tarnishing

Installation

- Trim only; requires valve to complete installation (sold separately)

Required Products/Accessories

K-11748 Series Rite-Temp® Valves

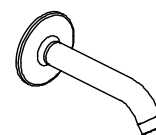
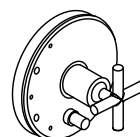
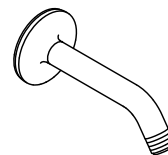

ADA

Codes/Standards









ASME A112.18.1/CSA B125.1
ADA

KOHLER® Faucet Lifetime Limited Warranty

See website for detailed warranty information.

Available Colors/Finishes

Color tiles intended for reference only.

Color	Code	Description
	CP	Polished Chrome
	SN	Vibrant® Polished Nickel
	BN	Vibrant® Brushed Nickel
	BV	Vibrant® Brushed Bronze
	BL	Matte Black
	2MB	Vibrant® Brushed Moderne Brass
	BGP	Vibrant Brushed Graphite
	TT	Vibrant Titanium

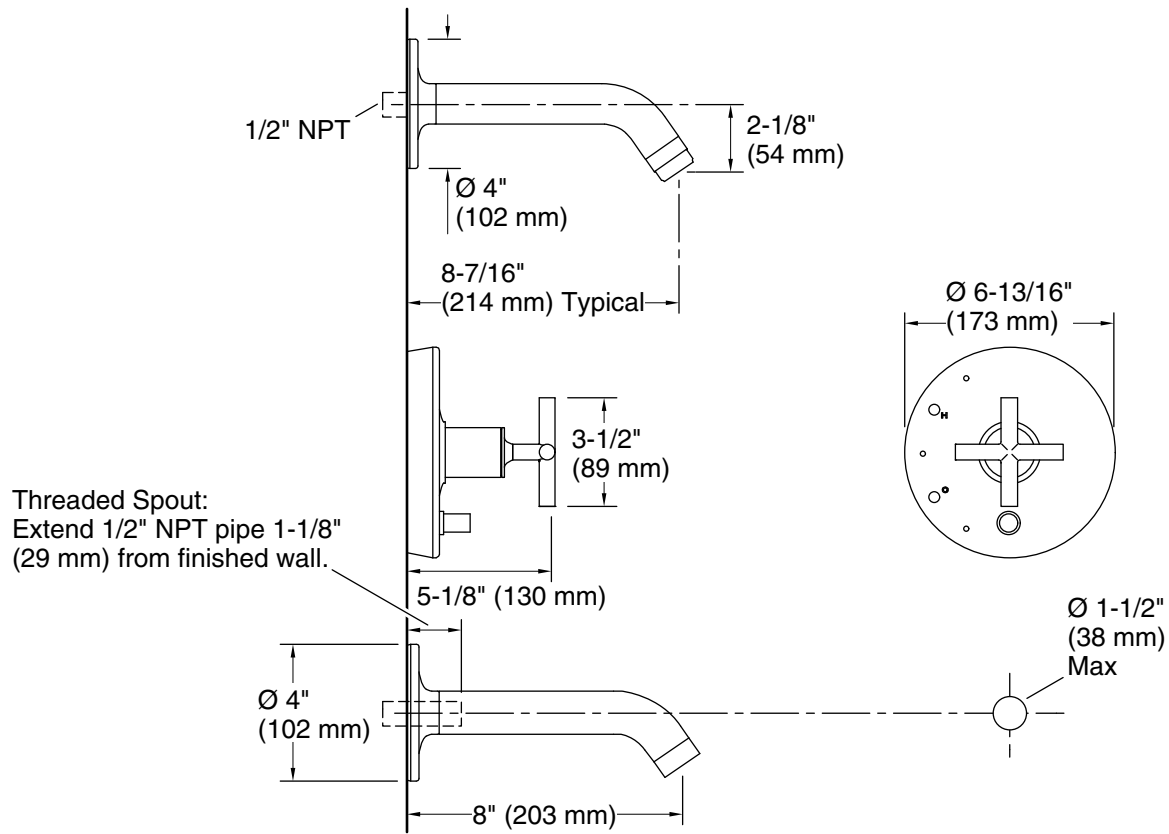

Technical Information

All product dimensions are nominal.

Spout:

Spout reach: 8" (204 mm)

Notes

Install this product according to the installation instructions.

Avoid cross-flow conditions. Do not install shut-off device on either valve outlet.

Cap the shower outlet if deck-mount spout, diverter, or handshower is connected to the spout outlet.

ADA compliant when installed to the specific requirements of these regulations.