

Features

- 36" (914 mm) minimum base cabinet width
- Single bowl
- 9" (229 mm) depth provides generous workspace
- Five oversized faucet holes
- Oversized holes allow for easy installation of faucets and accessories
- Bowl slopes toward drain to minimize water pooling
- Offset drain increases workspace in the sink and storage space underneath
- Included accessories: cutting board, drain board, colander / drying rack, soaking bin with drain, stainless steel bottom sink rack
- All included accessories nest neatly together for easy storage when not in use
- Drain board, colander / drying rack, soaking bin with drain, and bottom sink rack are dishwasher-safe

Material

- KOHLER® enameled cast iron
- Acid-resistant enamel finish

Installation

- Undermount

Recommended Products/Accessories

- K-23725 Cast iron cleaner
- K-23726 Drain treatment
- K-35007 Bifold multipurpose rack
- K-35002 Ice bucket holder
- K-35003 Workstation sink cover
- K-35004 HDPE cutting board
- K-35005 Marble serving tray
- K-35487 Three-piece ice bucket set
- K-35484 Three-piece workstation sink prep bowl set
- K-11352 Disposal Flange with Stopper
- K-8801 Sink drain and strainer with tailpiece
- K-8799 Sink drain and strainer basket

Optional Products/Accessories

- K-5807 36" Under-mount Sink Kit
- K-9000 P-Trap

Included Components

- K-35000 Three-piece workstation sink accessory set
- K-35001 Maple wood cutting board
- K-6237 Left-Bowl Sink Rack
- K-6255 Right-Bowl Sink Rack



Codes/Standards









ASME A112.19.1/CSA B45.2

KOHLER® Enameled Cast Iron Kitchen and Bathroom Sink Lifetime Limited Warranty

See website for detailed warranty information.

Available Colors/Finishes

Color tiles intended for reference only.

Color	Code	Description
	0	White
	FF	Sea Salt™
	96	Biscuit
	NY	Dune
	95	Ice™ Grey
	58	Thunder™ Grey
	7	Black Black™
	TRF	Truffle

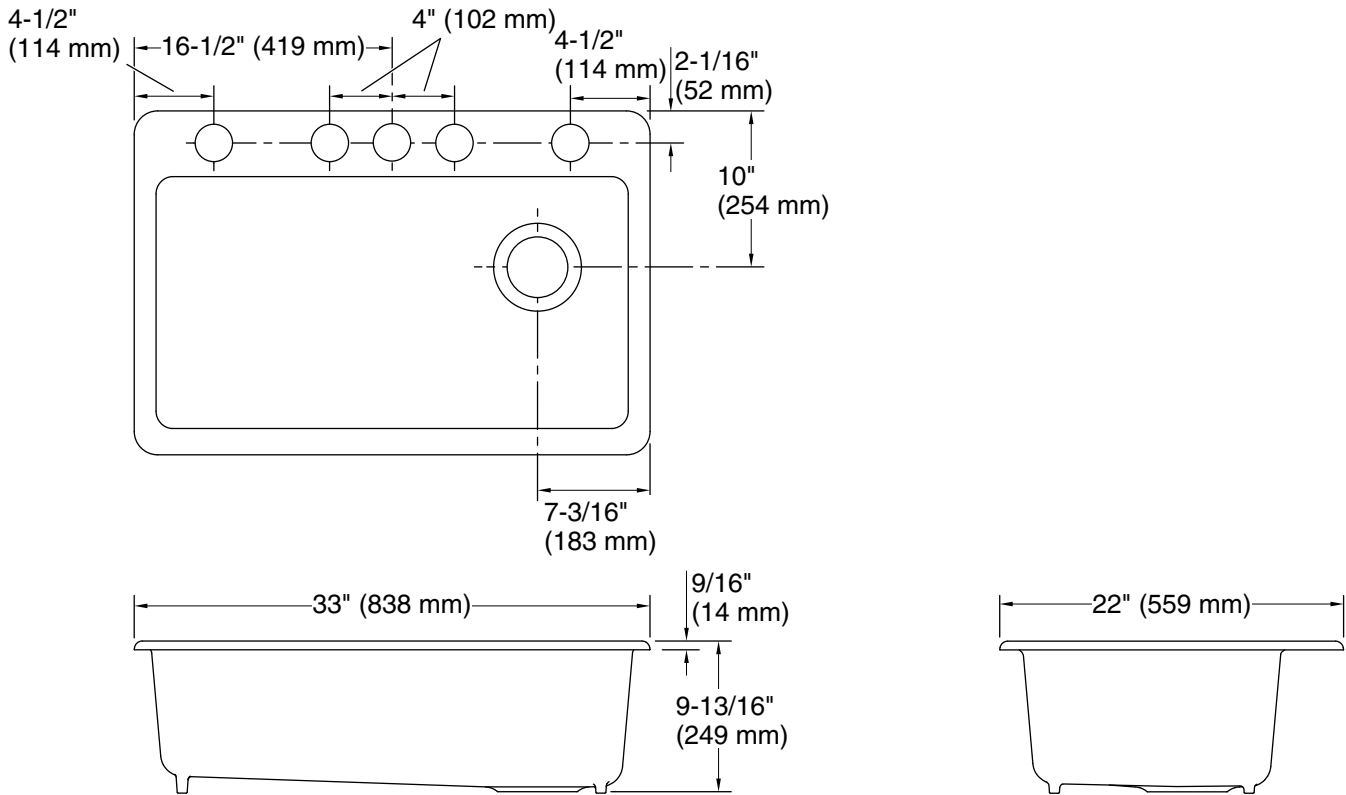

Technical Information

All product dimensions are nominal.

Basin configuration:	Single Bowl
Center(s):	8" (203 mm)
Min. base cabinet width:	36" (914 mm)
Bowl area (Basin #1):	Length: 30-1/4" (768 mm) Width: 15-13/16" (402 mm) Bowl depth: 9" (229 mm) Water depth: 9" (229 mm)
Number of deck holes:	5
Faucet hole(s):	2-3/8" (60 mm)
Drain hole:	3-7/8" (98 mm)
Template:	Undermount, 1166727-7, required, included

Notes

Install this product according to the installation instructions.

NOTICE: Countertop manufacturer or cutter must use the cut-out template provided with the product, or a current one provided by Kohler Co. (call 1-800-4KOHLER). Kohler Co. is not responsible for cutout errors when the incorrect cut-out template is used.