

KOHLER® Faucets **Billet™** Two-hole bridge kitchen sink faucet with side sprayer **K-28673-9**

Features

- High-arch spout and 360° spout rotation offer superior clearance for filling pots and cleaning
- Two round handles offer separate control of hot and cold water
- Matching side sprayer provides flexibility and convenience for cleaning and food prep
- 1.5 gpm (5.7 lpm) maximum flow rate at 60 psi (4.14 bar)
- Coordinates with other products in the Billet™ collection

Material

- Premium metal construction for durability and reliability
- KOHLER finishes resist corrosion and tarnishing

Installation

- Three-hole installation
- Flexible supply lines simplify installation



Codes/Standards









ASME A112.18.1/CSA B125.1
 NSF/ANSI/CAN 61
 NSF/ANSI/CAN 372
 DOE - Energy Policy Act 1992
 California Energy Commission (CEC)

KOHLER® Faucet Lifetime Limited Warranty

See website for detailed warranty information.

Available Colors/Finishes

Color tiles intended for reference only.

Color	Code	Description
	CP	Polished Chrome
	SN	Vibrant® Polished Nickel
	AF	Vibrant® French Gold
	VS	Vibrant® Stainless
	BV	Vibrant® Brushed Bronze
	BL	Matte Black
	2MB	Vibrant® Brushed Moderne Brass
	BMB	Matte Black with Moderne Brass
	TT	Vibrant Titanium

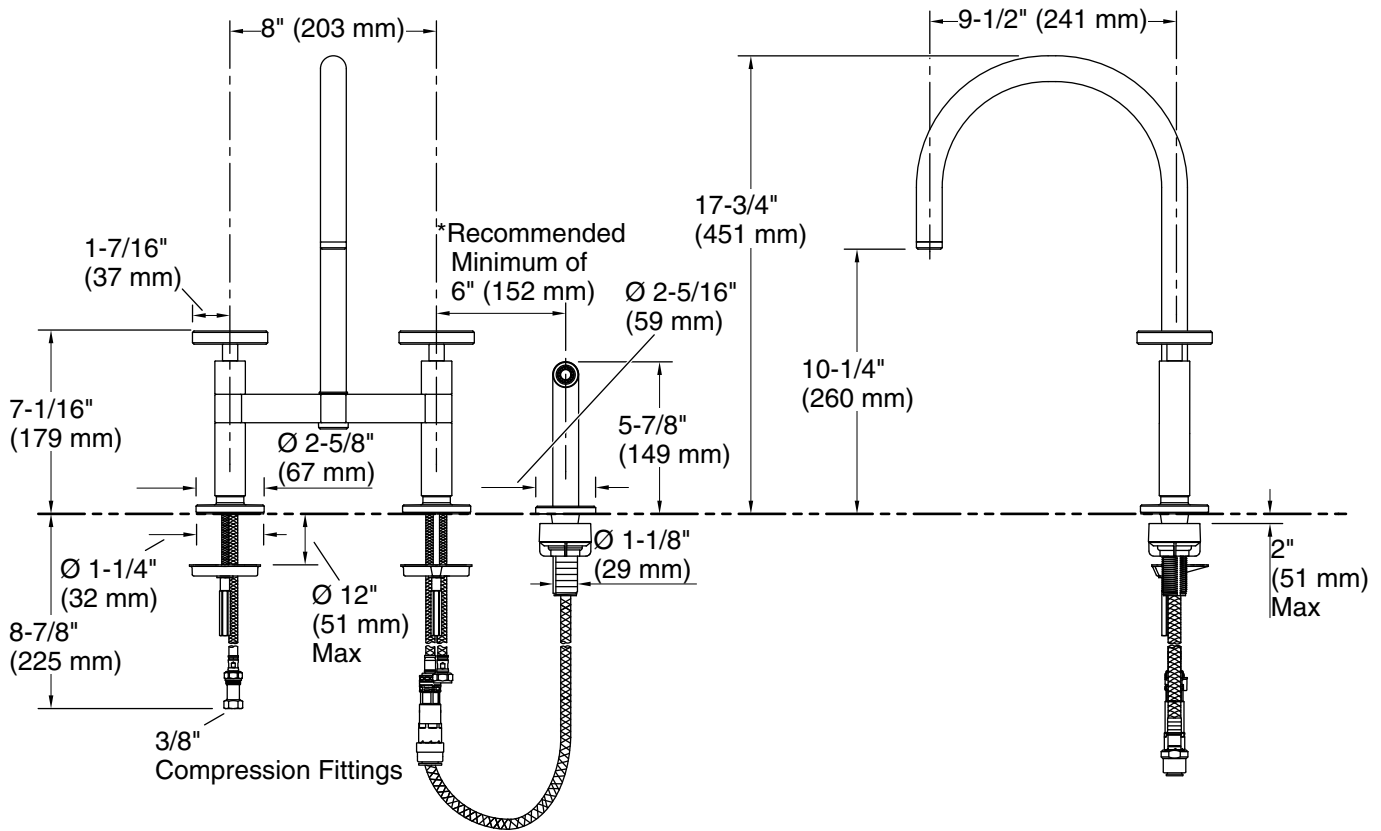

Technical Information

All product dimensions are nominal.

Faucet flow rate: 1.5 gal/min (5.7 l/min)

Spout:

Spout reach: 9-1/2" (241 mm)

Notes

Install this product according to the installation instructions.