

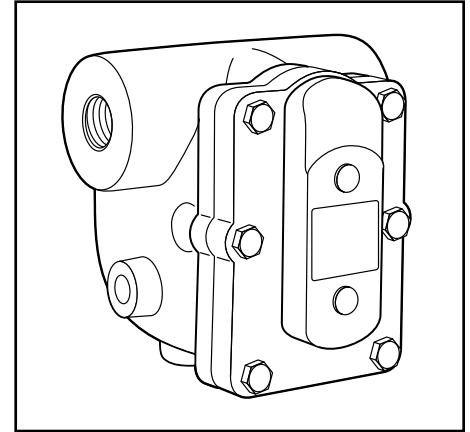







Series I In-line Float and Thermostatic Steam Traps

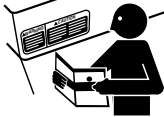

 WARNING	
	<ul style="list-style-type: none">• Before using product, read and understand instructions.• Save these instructions for future reference.
	<ul style="list-style-type: none">• All work must be performed by qualified personnel trained in the proper application, installation, and maintenance of steam systems in accordance with all applicable codes and ordinances.• To prevent serious burns, wear heat resistant gloves when opening and closing steam valves, or handling hot equipment.
	<ul style="list-style-type: none">• To prevent serious burns, the internal pressure of the trap must be 0 psi (0 bar) before servicing.• To prevent serious personal injury from steam pipe blow down, connect a temporary pipe between the steam pipe opening and a drain, or stand at least 100 ft. (30m) from the front of the pipe opening.
	<ul style="list-style-type: none">• To prevent property damage, personal injury, or death, cap off the gate valves if they are not connected to a drain and when they are not in use for test or pressure relief.
Failure to follow this warning could cause property damage, personal injury or death.	

<p>IMPORTANT: To prevent system damage from water hammer or sudden shock, open supply valves slowly.</p> <p>If you are uncertain about the product's adaptability for your application, please call the factory or authorized representative before using the product.</p>	<p>The trap seat rating (stamped on the nameplate) must be equal to or greater than the maximum pressure differential across the trap.</p>
---	--

OPERATION

START-UP

The balanced pressure thermostatic element is **open** to vent air from the steam space into the return line.

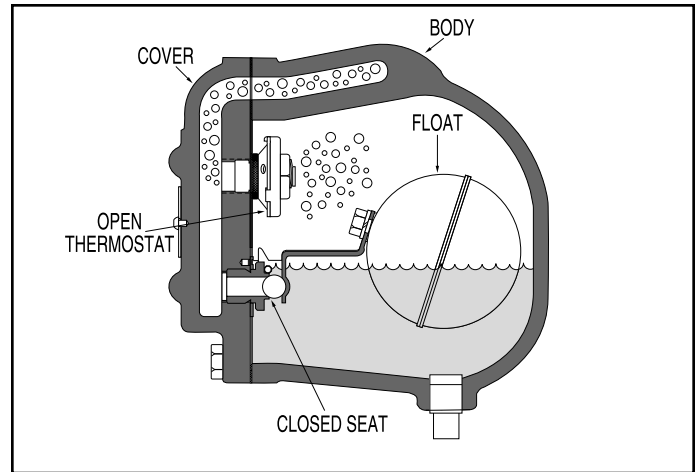

NORMAL OPERATION

The balanced pressure thermostatic element is **closed** to prevent the loss of steam into the return line.

The float will modulate to provide continuous drainage of condensate.

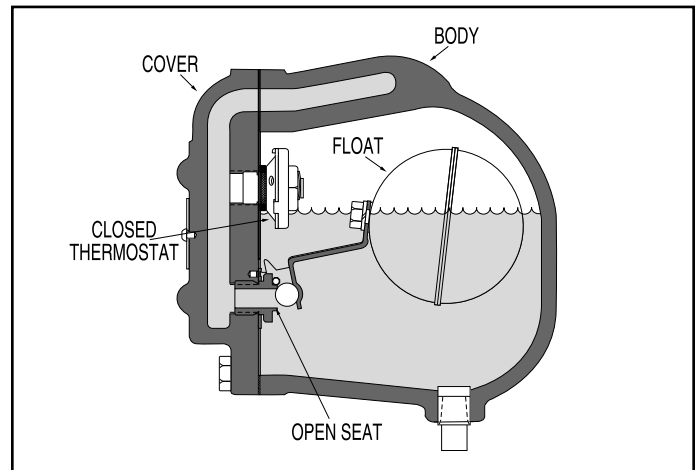

INSTALLATION –

Series I In-line Float and Thermostatic Steam Traps

1. Determine where to install the trap, based on the following requirements:

- a. The trap must be located as close as possible and below the equipment to be drained.
- b. The trap must be in a straight run of horizontal pipe and pitched to allow condensate to flow into the trap inlet and away from the trap outlet. Refer to the Typical Piping Diagrams at the right.
- c. Plenty of space around the trap is needed for servicing, which may include removal of the body or cover.

TYPICAL PIPING DIAGRAMS

Trap Draining to Open Drain

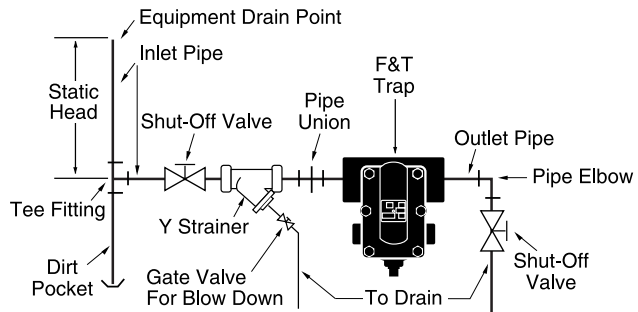

Trap Draining to Gravity Return Line

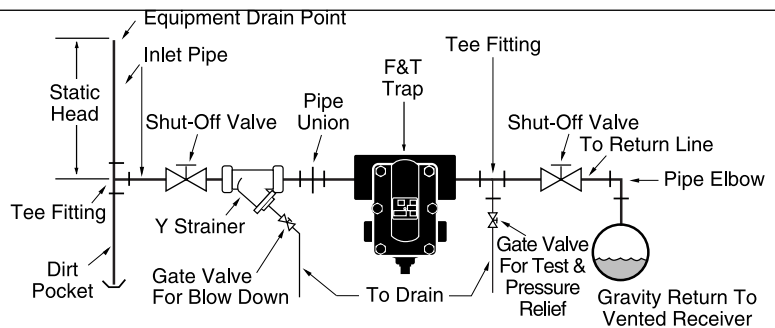

Trap Draining to Overhead Return Line or Pressurized Return Line

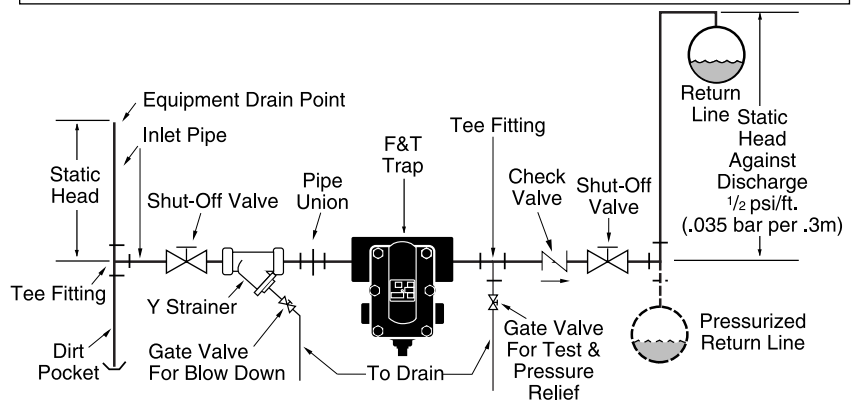

2. Install a shut-off valve (A) on the inlet pipe (B).

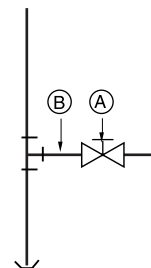

3. Install a Y Strainer (C) on the inlet pipe (B).

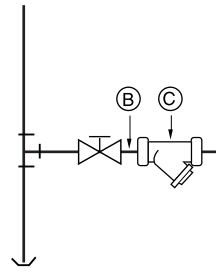

4. Install a gate valve for blow down (D) by connecting it to the Y Strainer drain tapping (C).

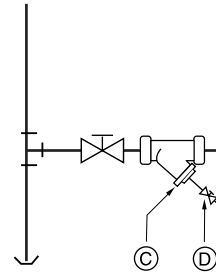

5a. Cap off the outlet pipe (X).

b. **Slowly** turn steam on with full pressure for (5) five minutes to blowdown the inlet pipe (B).

c. Turn off steam and allow pipe to cool.

d. Remove cap from the outlet pipe (X).

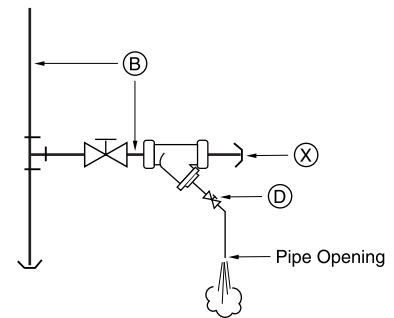

WARNING

To prevent serious personal injury from steam pipe blow down, connect a temporary pipe between the steam pipe opening and a drain, or stand at least 100 ft. (30m) from the front of the pipe opening.

Failure to follow this warning could cause property damage, personal injury, or death.



CAUTION

To prevent serious burns, the internal pressure of the trap must be 0 psi (0 bar) before servicing.

Failure to follow this caution will cause personal injury.

6. Close the gate valve (D). If it is not connected to a drain, install a cap (E) on the outlet pipe (F).
Note: Remove the cap (E) when the gate valve (D) is used for test or pressure relief. Recap when the test or pressure relief is complete.

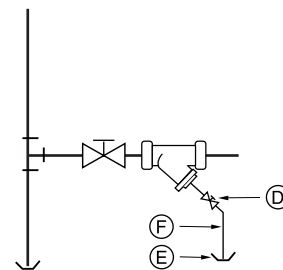

WARNING

To prevent property damage, personal injury, or death, cap off the gate valve if it is not connected to a drain and when it is not in use for test or pressure relief.
 Failure to follow this warning could cause property damage, personal injury, or death.

7. Install a pipe union (G) on the inlet pipe (B).

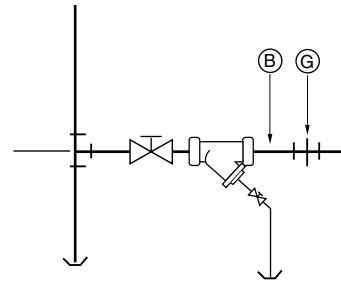

8. Position the F&T trap so that the inlet pipe (B) will connect with the "IN" tapping on the body (H), and the "DOWN" arrow (J) is pointing down.

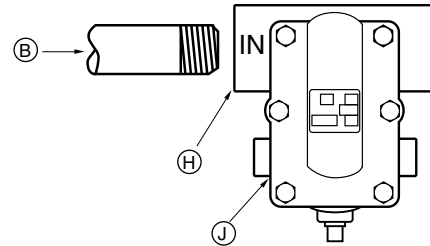

9. Install the F&T trap (K) on the inlet pipe (B) as positioned in Step 8.

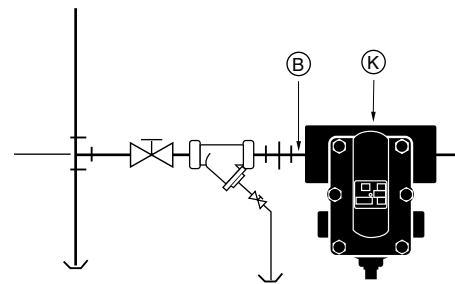

For Applications with a Return Line

10. Install a tee fitting (L) on the return line (M) near the trap outlet (N).

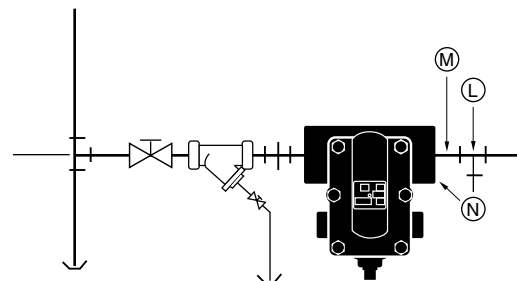

11a. Install a gate valve (P) on the outlet pipe (Q) for test or pressure relief.

b. Close the gate valve (P).

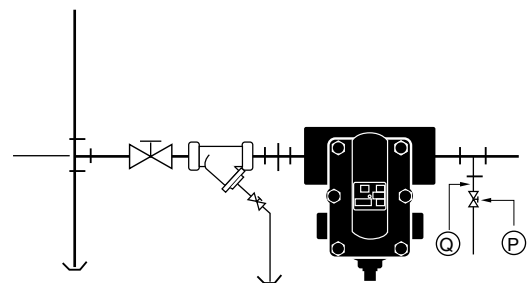

12. If the gate valve (P) is not connected to a drain, install a cap (R) on the outlet pipe (Q).
Note: Remove the cap (R) when the gate valve (P) is used for test or pressure relief. Recap when the test or pressure relief is complete.

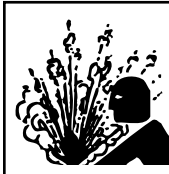
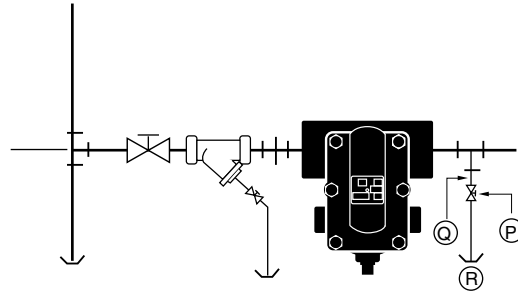

WARNING

To prevent property damage, personal injury, or death, cap off the gate valve if it is not connected to a drain, and when it is not in use for test or pressure relief. Failure to follow this warning could cause property damage, personal injury, or death.

For Applications with a Gravity Return, Pressurized Return or Return Line Above the Trap Discharge

13. Install a check valve (S) on the return line (M).

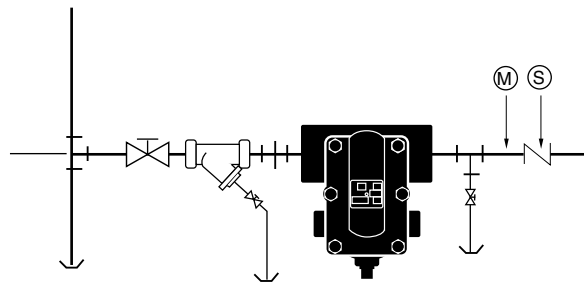

For All Series Applications

14. Install a shut-off valve (T) on the return line (M).

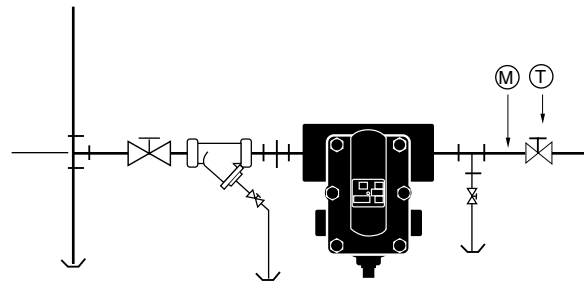

15. Depending on your application, complete one of the following steps:

a. Connect the return line (M) to a drain (U)

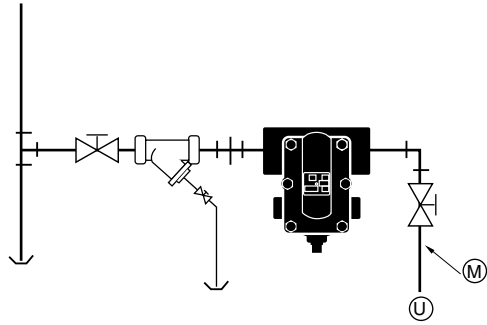

OR

b. Add a gravity return line (V)

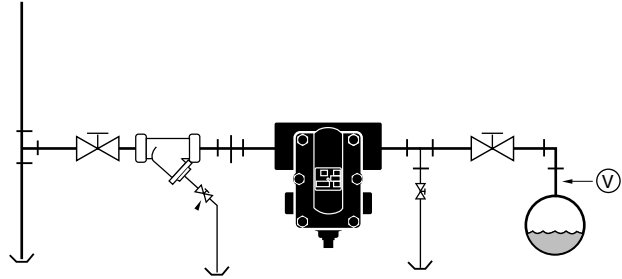

OR

c. Add a pressurized return (W) or a return line above the trap discharge (X).

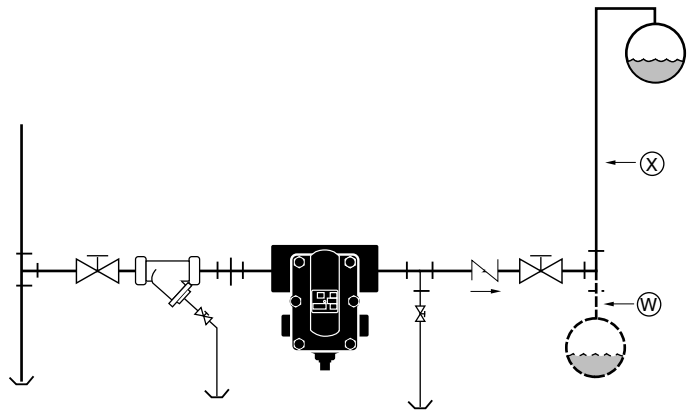

INSTALLATION COMPLETE

MAINTENANCE

When checked regularly and properly maintained, the Series I Float and Thermostatic Traps will provide optimum performance and long life.

SCHEDULE:

- Initially, every 2-3 days after start-up until system is clean.
- Every 6 months thereafter.

PROCEDURE:

1. Inspect joints for leaks. Stop all leaks by tightening bolts and replacing gaskets, if necessary.
2. Clean strainers by opening the blow down valve and allowing full steam pressure to flow out for (2) two minutes. Then, close the valve.
3. Test traps by following the "Troubleshooting" procedure.



CAUTION

- To prevent serious burns, the internal pressure of the trap must be 0 psi (0 bar) before servicing.
- To prevent serious personal injury from steam pipe blow down, connect a temporary pipe between the steam pipe opening and a drain, or stand at least 100 ft. (30m) from the front of the pipe opening.

Failure to follow this caution will cause personal injury.



TROUBLESHOOTING

We recommend trap replacement when parts no longer operate properly. A new trap or a complete cover assembly is more economical than repairing or replacing individual parts, and it will provide greater

Problem:

1. Improper Heating

- a. **Cause:** The float assembly is not opening or functioning properly. This could be caused by a leak in the float.

Test: Use a thermometer to test inlet temperature. A cold trap is an indication the trap failed closed.

Solution: Disassemble the trap. Shake the float, listening for water, and inspect for leaks. Replace any worn or defective parts.

- b. **Cause:** The steam pressure is higher than the trap's seat rating pressure which prevents the trap from opening.

Test: Check the seat pressure rating on the In-line F&T trap nameplate with the available steam pressure to the equipment being drained.

Solution: Install a new Hoffman Specialty Bear Trap® with the proper pressure range.

Note: The trap must be selected for the maximum differential pressure that will be encountered. A high pressure seat may be used at lower differential pressures, but the capacity rating will be less than an identical size trap with a low pressure rated seat.

- c. **Cause:** Full capacity drainage is prevented by worn linkage.

Test: Disassemble the trap and inspect for worn parts.

Solution: Install a new Hoffman Specialty In-line F&T Bear Trap®.

reliability. If you choose to repair the trap, order Hoffman Specialty replacement parts and follow the Repair Procedure provided.

Problem:

2. Energy Wasted

- a. **Cause:** A worn pin and seat, or dirt deposited on the seat prevents tight closure.

Test: Using a stethoscope, listen for a low pitch whistle sound. A low pitch whistle sound indicates the trap is open and blowing live steam.

Solution: Disassemble the trap and inspect for dirt or worn parts. Clean if dirty, or replace if worn.

- b. **Cause:** The thermostatic element failed open and is blowing live steam.

Test: Using a stethoscope, listen for a low pitch whistle sound. A low pitch whistle sound indicates the trap is open and blowing live steam.

Solution: Disassemble the trap and replace the thermostatic element