

Part No.	Reference No.	Quantity	Description
0000094262~S	*		ELECTRICAL CONTROL BOX
0000094258~S	*		GENERAL ASSEMBLY
0000094260~S	*		HEAT EXCHANGER, BLOWER ASSEMBLY, FLUE COLLECTOR, POWER VENTER & TURBULATORS
0000094261~S	*		MANIFOLD BURNER ASSEMBLY
0000094259~S	*		MODEL NUMBER DESCRIPTION
0000094208~S	*		PANELS & LOUVERS

Part No.	Reference No.	Quantity	Description
000008160~P	*		ELECTRICAL CONTROL BOX PARTS LIST

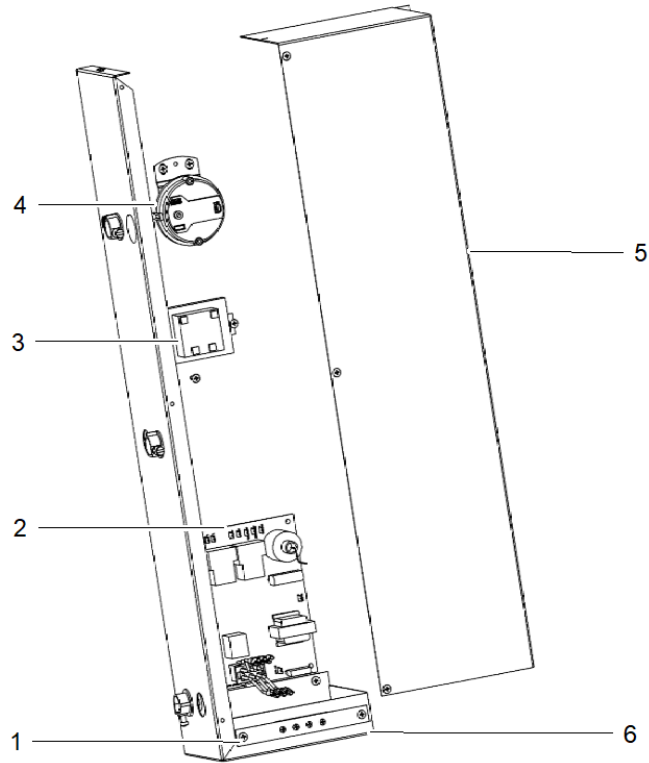

All orderable Service Parts are identified for this product.
Parts that are not identified, will not be available to order.

Parts List Number :000094220

Model Number :GNNE020ATA20000

Part No.	Reference No.	Quantity	Description
PLT05204	1	1	PLATE; TERMINAL BLOCK
BRD03396	2	1	BOARD; CONTROL
TRR01251	3	1	TRANSFORMER; 50VA, 120V PRI., 24V SEC
SWT03800	4	1	SWITCH; AIR PRESSURE, STD ALT (0-4,999 FT)
SWT03802	4a	1	SWITCH; AIR PRESSURE, HIGH ALT (5,000 FT+)
COV02682	5	1	COVER; CONTROL BOX
BOX01188	6	1	BOX; CONTROL

Part No.	Reference No.	Quantity	Description
000008755~P	*		GENERAL ASSY GN

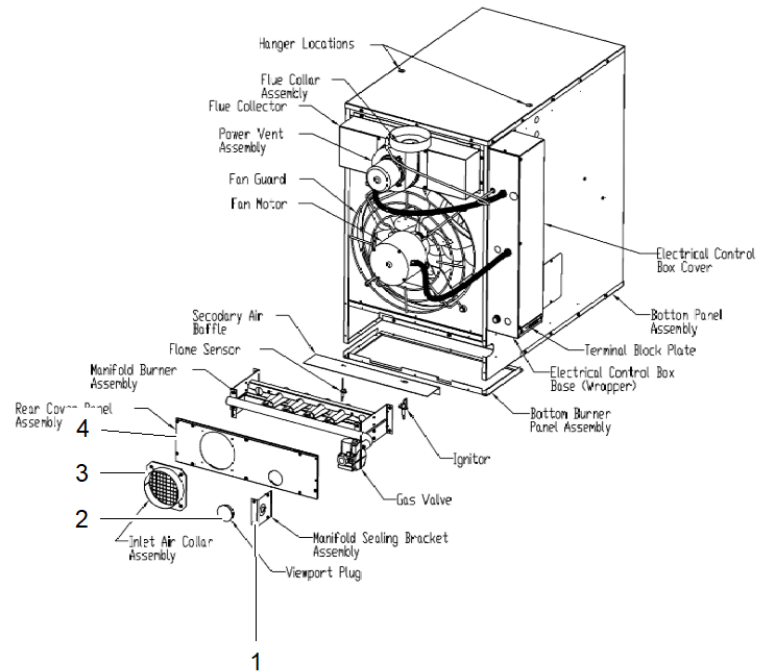

All orderable Service Parts are identified for this product.
Parts that are not identified, will not be available to order.

Part No.	Reference No.	Quantity	Description
BRK05237	1	1	BRACKET; MANIFOLD SEALING ASSY
GLS01083	2	1	GLASS; PEEP HOLE SIGHT
CLR00906	3	1	COLLAR; INLET AIR
PNL37228	4	1	PANEL; REAR COVER

Parts List Number :000094220

Model Number :GNNE020ATA20000

Part No.	Reference No.	Quantity	Description
000008002~P	*		HEAT EXCHANGER, BLOWER ASSEMBLY, FLUE CO

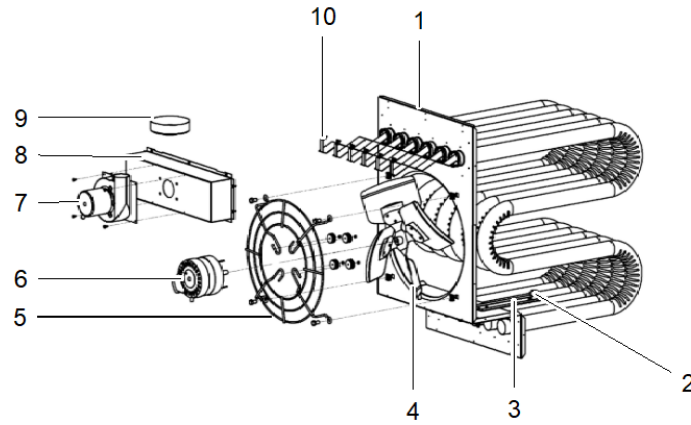

All orderable Service Parts are identified for this product.
Parts that are not identified, will not be available to order.

This is an optional feature. This is not a factory option.

Part No.	Reference No.	Quantity	Description
KIT16766	*	1	KIT; FAN/GUARD/MOTOR MOUNT HARDWARE KIT [QTY. REQ'D PER CAPACITY]
EXC02532	1	1	EXCHANGER; VESTIBULE PANEL/TUBE ASSY, STAINLESS (HEAT EXCHANGER, INCLUDES TURBULATORS)
SWT01036	2	1	SWITCH; AUXILARY CONTROL, HIGH LIMIT, 60T23-203675, F170-40, OPENS 130F, CLOSES 170F
BRK02536	3	1	BRACKET; HIGH LIMIT
FAN04813	4	1	FAN; BLADE
GRD02103	5	1	GUARD; FAN GUARD, INCLUDES MOTOR MOUNTING PLATE
MOT07943	6	1	MOTOR; BLOWER W/CAPACITOR, 1/3 HP, 5.8 AMP, 120/60, OPEN DRIP PROOF
BLW00660	7	1	BLOWER; ASM., COMBUSTION AIR, W/MOTOR 115/60, 1.8A,
FLU00221	8	1	FLUE; COLLECTOR BOX 200 TUBULAR
ADP00491	9	1	ADAPTER; ASM., FLUE COLLAR
TRB00229	10	8	TURBULATOR;

Part No.	Reference No.	Quantity	Description
000008722~P	*		MANIFOLD BURNER ASSEMBLY PARTS LIST



All orderable Service Parts are identified for this product.
Parts that are not identified, will not be available to order.

Parts List Number :000094220

Model Number :GNNE020ATA20000

Part No.	Reference No.	Quantity	Description
CNT05013	1	1	CONTROL; SPARK IGNITOR
BNR01034	2	8	BURNER;
SEN02145	3	1	SENSOR; FLAME SENSOR, DS, 1.500"
ORF01748	5	8	ORIFICE; STANDARD ORIFICE, (NATURAL GAS)
VAL08914	6	1	VALVE; SINGLE STAGE NATURAL GAS
MFD00844	7	1	MANIFOLD;
BRK04427	8	1	BRACKET; MANIFOLD BRACKET SUB-ASSY

Part No.	Reference No.	Quantity	Description
000007961~P	*		MODEL NUMBER DESCRIPTION

MODEL NUMBER DESCRIPTION		75013797	REV A
Tubular Propeller Fan Units GN Models			
MODEL NUMBER EXAMPLE G H N E 0 2 0 A T A 1 0 0 0 J 1 2 3 4 5 6 7 8 9 10 11 12 13 14 15			
Digit: 1 - Gas Heating Equipment		Digit 12, 13, 14	
G = Gas Heating		0 = None	
		S = Special	
Digit: 2 - Unit Type		Digit 15 - Miscellaneous Options	
N = Tubular Propeller Fan Unit		0 = None	
		A = #409 Stainless Steel Burners	
Digit: 3 - Fuel Type		B = Air Pressure Switch for Elevation Above 5000 Feet	
N = Natural Gas		C = #409 Stainless Steel Flue Collector	
P = Propane Gas (LP)		D = Summer-Winter Switch	
S = Special		E = Vertical Louvers	
Digit 4 - Development: Sequence		J = Totally Enclosed Motor	
E = Fifth Generation etc		7 = OSHA Fan Guard	
Digit 5,6,7 - Input Capacity			
010 = 100 MBh			
012 = 125 MBh			
015 = 150 MBh			
017 = 175 MBh			
020 = 200 MBh			
025 = 250 MBh			
030 = 300 MBh			
035 = 350 MBh			
040 = 400 MBh			
Digit 8 - Main Power Supply			
A = 115/60/1			
B = 230/60/1			
C = 208/60/3			
D = 230/60/3			
E = 460/60/3			
F = 575/60/3			
G = 208/60/1			
S = Special			
Digit 9 = Gas Control Option			
H = Electronic Modulating W/Room Sensing			
L = Electronic Modulating W/External 4-20 mA Input			
N = Electronic Modulating W/External 0-10 VDC Input			
T = Single Stage, Direct Spark Ignition			
V = Two Stage, Direct Spark Ignition			
S = Special			
Digit 10 - Design Sequence			
A = First Design			
Digit 11 = Heat Exchanger Material			
1 = Standard (Aluminized Steel)			
2 = #409 Stainless Steel			
S = Special			

Part No.	Reference No.	Quantity	Description
000008101~P	*		PANELS & LOUVERS PARTS LIST

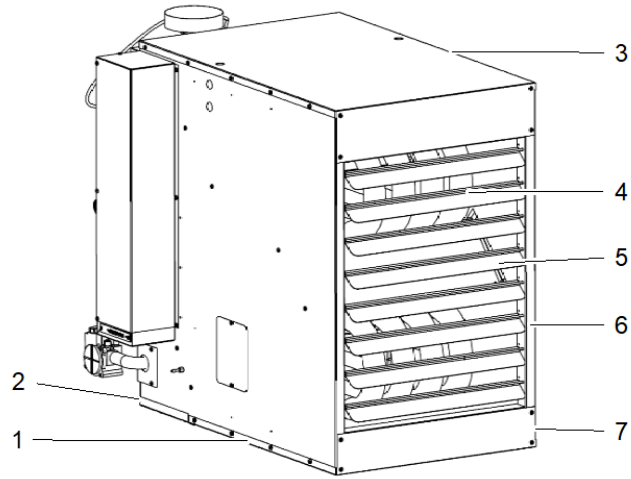

All orderable Service Parts are identified for this product.
Parts that are not identified, will not be available to order.

Part No.	Reference No.	Quantity	Description
CAB01185	*	1	CABLE; IGNITION-36 IN. LONG
CON01299	*	1	CONNECTOR; MOLEX ASSY(LEADS 19 IN LONG)
TUB13641	*	1	TUBING; VINYL, (PRESSURE SWITCH)
PNL37222	1	1	PANEL; RIGHT SIDE JACKET, W/ INSULATION
PNL37227	2	1	PANEL; BOTTOM BURNER
PNL30474	3	1	PANEL; TOP JACKET, W/ INSULATION
SPG00194	4	8	SPRING; CONE, ADJUSTABLE LOUVERS FOR HORZ. AND VERT.(ORDER QTY EQUALS PIECES)
LVR00110	5	8	LOUVER;
PNL30476	6	1	PANEL; LEFT SIDE JACKET, W/ INSULATION
PNL37226	7	1	PANEL; BOTTOM JACKET, W/ INSULATION