

Installation and Operation Manual

prioAir





Inline Duct Fan



prioAir 6
prioAir 6-EC



prioAir 8
prioAir 8-EC
prioAir 10
prioAir 10-EC

				
Note	Warning / Important note	Information	Technical information	Practical tip



1. prio**Air** is an axial duct fan intended for installation in ventilation systems. Stand alone versions were not evaluated by UL and would void their marking.
2. CAUTION: This duct fan shall be installed at minimum of 1 m (3 ft) from any accessible opening of the duct."
3. CAUTION: For General Ventilation Use Only. Do Not Use To Exhaust Hazardous Or Explosive Material and Vapors. prio**Air** is suitable for clean air, air with low dust and grease content, and media up to max. density of 0.081 lb/ft³ (or 1.3 kg/m³).
4. CAUTION: prio**Air** is suitable for temperature ranges between -13°F to +131°F (-25°C to +55°C).
5. Remove unit from packaging and inspect within 15 days after receipt. If damaged, report damage to carrier. Do NOT operate this unit with visible damage to the blower or impeller assembly.
6. Cordless units are NOT to be used with rigid conduit. Flex conduit (1/2 inch) is recommended for permanent installations.
7. Corded models are available and are factory wired. If using a corded model the following installations are required:
 - a. Do NOT Use in junction with an extension cord.
 - b. If installed outdoors – Use only with GFCI protected receptacles.
 - c. Do NOT operate any fan with a damaged cord or plug.
 - d. Do NOT run cord under carpeting.
 - e. Do NOT cover cord with throw rugs, runners, or similar coverings.
 - f. Arrange cord away from traffic areas to avoid tripping hazards.
8. An appropriate duct termination device (roof cap, wall cap, louvered shutters, etc.) are to be used with this fan.

Warnings

1. **TO REDUCE THE RISK OF FIRE, ELECTRICAL SHOCK, OR INJURY TO PERSONS, OBSERVE THE FOLLOWING:**
 - a. Use this unit in the manner intended by the manufacturer. If you have any questions, contact your manufacturer's representative.
 - b. Before servicing or cleaning unit, switch power off at service panel and lock the service disconnecting means to prevent power from being switched on accidentally. If the service disconnecting means cannot be locked, securely fasten a prominent warning device, such as a tag, to the service panel. For corded models, unplug the fan from the power supply.
 - c. Installation work and electrical wiring must be done by qualified person(s) in accordance with all applicable codes and standards, including fire-rated construction.
 - d. Sufficient air is needed for proper combustion and exhausting of gases through the flue (chimney) of fuel burning equipment to prevent back drafting. Follow the heating equipment manufacturer's guideline and safety standards such as those published by the National Fire Protection Association (NFPA), and the American Society for Heating, Refrigeration and Air Conditioning Engineers (ASHRAE), as well as your local code authorities.
 - e. When cutting or drilling into the wall and ceiling, do not damage electrical wiring or other hidden utilities.
 - f. Ducted fans must always be vented to the outdoors.
 - g. NEVER place a switch where it can be reached from a tub or shower.
2. **WARNING! Check the voltage on the fan faceplate to verify it corresponds to the motor name plate rating.**

Dimensions

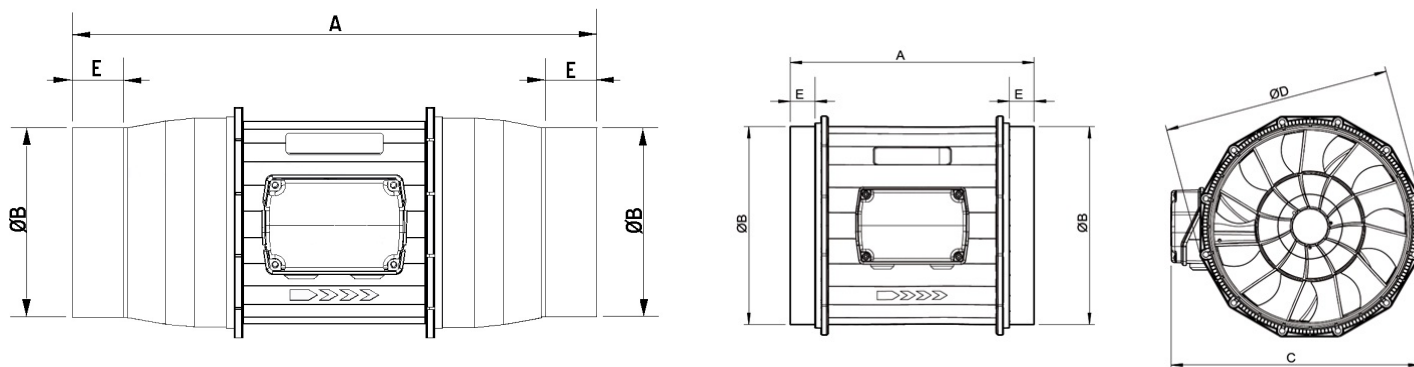

Model	A	B	C	D	E
prioAir 6	16 ³ / ₁₆	5 ⁷ / ₈	8 ¹ / ₄	7 ³ / ₈	1 ⁵ / ₈
prioAir 6-EC	16 ³ / ₁₆	5 ⁷ / ₈	8 ¹ / ₄	7 ³ / ₈	1 ⁵ / ₈
prioAir 8	9 ¹¹ / ₁₆	7 ⁷ / ₈	9 ³ / ₄	9	1
prioAir 8-EC	9 ¹¹ / ₁₆	7 ⁷ / ₈	9 ³ / ₄	9	1
prioAir 10	11 ¹³ / ₁₆	9 ¹³ / ₁₆	11 ¹⁵ / ₁₆	11 ¹³ / ₁₆	1 ³ / ₁₆
prioAir 10-EC	11 ¹³ / ₁₆	9 ¹³ / ₁₆	11 ¹⁵ / ₁₆	11 ¹³ / ₁₆	1 ³ / ₁₆

All dimensions in inches

Installation

The prioAir ventilation fan may be mounted in either the horizontal or vertical orientation. Each fan is designed with a series of mounting holes, patterned around the center axis of the fan which provides optimum control of the electrical box orientation during installation.

All prioAir units come standard with a mounting bracket (shown below) and mounting hardware.

Mounting options

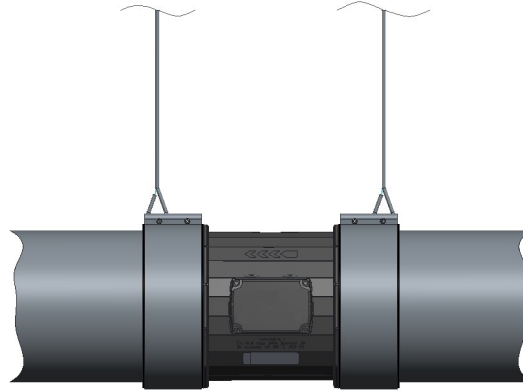
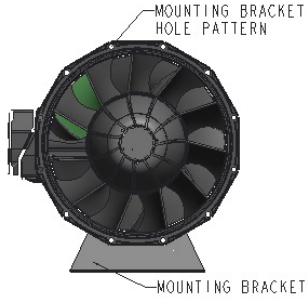

Horizontal Installation
Suspended

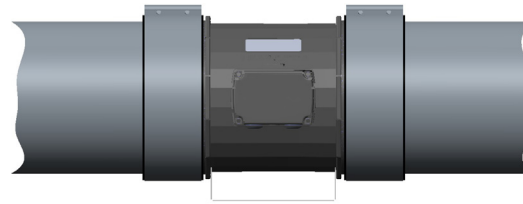

Horizontal Installation
Mounting Bracket

Vertical Installation
Mounting Bracket

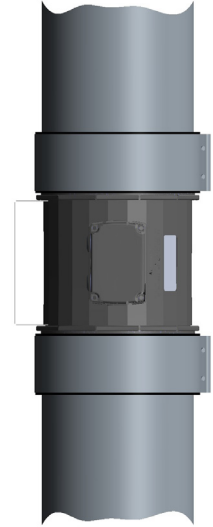

1. When installing, keep the number of elbows and bends to a minimum. If necessary, long radius elbows or bends are recommended.
2. Duct Sealant, caulk, or tape should be applied to all seams to prevent air leakage and maximize air performance.
3. Flex, spiral, or snap lock ducting may be used. If using rigid duct, Fantech FC clamps are recommended to connect duct work to the fan (see above illustrations).
4. To minimize static pressure losses and promote adequate airflow, minimize duct run lengths where possible. If using flex duct, keep duct runs straight and taut.
5. If installing in an unconditioned space, covering the fan with insulation is recommended to prevent condensation from forming.
6. For general ventilation applications, at least 8 ft of insulated flexible duct shall be installed between the exhaust or supply grille(s) and the fan.

Wiring

Models prioAir 6 and prioAir 8

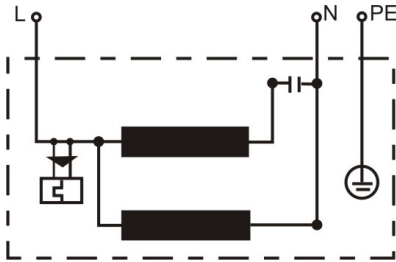

Factory Motor Wiring (For reference only)	Terminal Marking	Field Wiring to be Completed by Installer
Color		Function
blue	L	Power supply 120VAC, 50/60 Hz
black	N	Neutral conductor
green/yellow	PE	Protective conductor

Models prioAir 6-EC and prioAir 8-EC

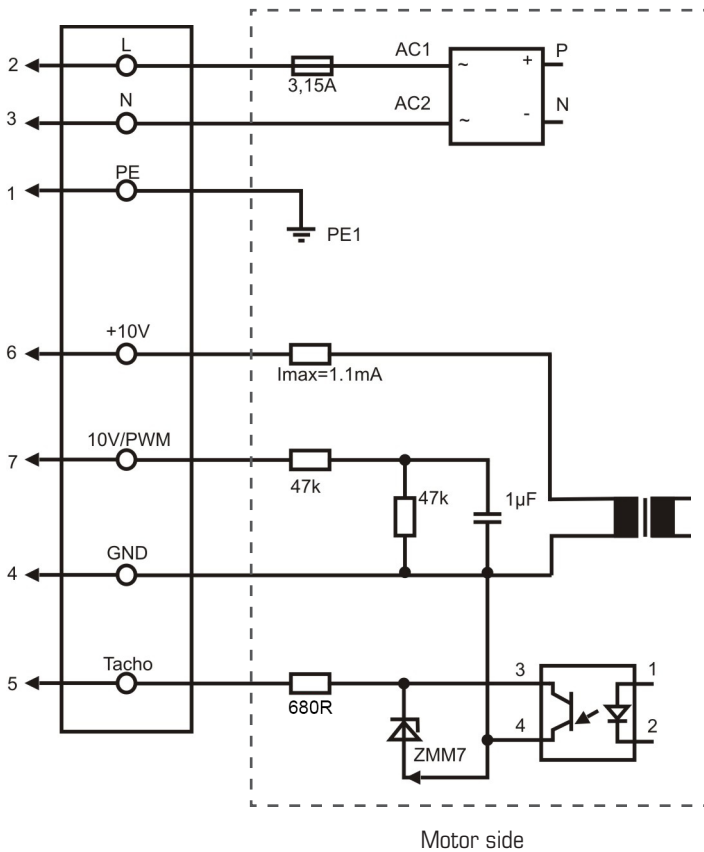

Factory Motor Wiring (For reference only)	Terminal Marking	Field Wiring to be Completed by Installer
Color		Function
Brown	L	Power supply 120VAC, 50/60 Hz
Blue	N	Neutral Conductor
Green/Yellow	PE	Protective Conductor
Red	+10V	Voltage Output 10V/1.1mA, Electrically Isolated
Yellow	10V/PWM	Controller Input 0...10V or PWM, Electrically Isolated
Blue	GND	GND- Connection to the Controller Interface
White	Tacho	Speed Output: Open Collector; 1 Impulse per revolution, electrically isolated Isink_max=10mA

Control Options (for prioAir 6EC and PrioAir 8EC models)

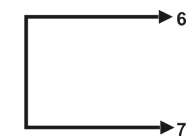

Maximum Speed

Place Jumper Between Terminals 6 and 7

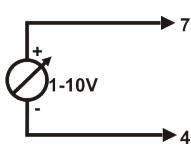

Adjustable Speed

10V | n = max
1V | n = min
< 1V | n = 0

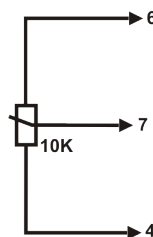

Potentiometer

Speed Controlled

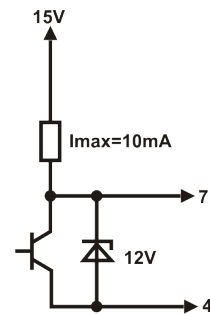

Adjustable Speed Through PWM 1... 10kHz

100% PWM | n = max
10% PWM | n = max
<10% PWM | n=0

Warranty

Fantech, Inc. warrants to the original purchaser that our products will be free from defects in material and workmanship for a period of five (5) years from the date of shipment. THIS IS OUR SOLE AND EXCLUSIVE PRODUCT WARRANTY AND IS IN LIEU OF AND EXCLUDES ALL OTHER WARRANTIES, EXPRESS OR IMPLIED, ARISING BY OPERATION OF LAW OR OTHERWISE, INCLUDING WITHOUT LIMITATION, MERCHANTABILITY AND FITNESS FOR A PARTICULAR PURPOSE WHETHER OR NOT THE PURPOSE OR USE HAS BEEN DISCLOSED TO US IN SPECIFICATIONS, DRAWINGS OR OTHERWISE, AND WHETHER OR NOT OUR PRODUCTS ARE SPECIFICALLY DESIGNED AND/OR MANUFACTURED BY US FOR PURCHASER'S USE OR PURPOSE.

This warranty does not cover any losses or damages due to misuse, accident, abuse, neglect, normal wear and tear, negligence (other than ours), unauthorized alteration, use beyond rated capacity, or improper installation, maintenance or application. This warranty shall be null and void to the extent that purchaser supplied incorrect information to us about the necessary product specifications or the environment in which the products were to be used, and our selection or design of the products for the purchaser was based in part on such information.

Limitation of Warranty and Liability

THE SOLE AND EXCLUSIVE REMEDY FOR BREACH OF ANY WARRANTY HEREUNDER SHALL BE LIMITED TO REPAIR, CORRECTION OR REPLACEMENT, OR REFUND OF THE PURCHASE PRICE UNDER THE PRECEDING PARAGRAPH ENTITLED "LIMITED WARRANTY". FANTECH VENTILATION PRODUCTS SHALL NOT BE LIABLE FOR DAMAGES CAUSED BY DELAY IN PERFORMANCE AND IN NO EVENT, REGARDLESS OF THE FORM OF THE CLAIM OR CAUSE OF ACTION, SHALL OUR LIABILITY TO PURCHASER AND/OR ITS CUSTOMERS EXCEED THE PRICE PAID BY PURCHASER FOR THE SPECIFIC PRODUCT PROVIDED BY US THAT GAUGE RISE TO THE CLAIM OR CAUSE OF

If within thirty (30) days after purchaser's discovery of any warranty defects within the warranty period, purchaser notifies us thereof in writing, we shall, at our option, repair, correct or replace F.O.B. point of manufacture, or refund the purchase price for, the products that we have found to be defective. Failure by purchaser to give such written notice within the 30-day time period shall be deemed an absolute and unconditional waiver of purchaser's claim for such defects. Products repaired or replaced shall be covered by this warranty for the remainder of the original warranty period or ninety (90) days from the date of shipment, whichever is longer.

Warranty claims should be sent to Fantech, Inc., Attn: Quality Department, 10048 Industrial Blvd., Lenexa, KS 66215. Included in the claim should be Order Number, Model Numbers, Serial Numbers and a detailed description of the issues.

Purchaser assumes all other responsibility for any loss, damage or injury to persons or property arising out of the use of our products, either alone or in combination with other products or components.

ACTION. PURCHASER AGREES THAT IN NO EVENT SHALL OUR LIABILITY TO PURCHASER AND/OR ITS CUSTOMERS EXTEND TO INCLUDE INCIDENTAL, CONSEQUENTIAL OR PUNITIVE DAMAGES. The term "consequential damages" shall include, but not be limited to, loss of anticipated profits, business interruption, loss of use or revenue, cost of capital, or loss or damage to property or equipment. It is expressly understood that any technical advice furnished by us with respect to the use of our products is given without charge, and we assume no obligation or liability for the advice given, or results obtained, all such advice being given and accepted.

Warning

Fantech products are designed and manufactured to provide reliable performance, but they are not guaranteed to be 100% free from defects. Even reliable products will experience occasional failures and this possibility should be recognized by the user. If these products are

used in a life support ventilation system where failure could result in loss or injury, the user should provide adequate backup ventilation, supplementary natural ventilation, failure alarm system, or acknowledge willingness to accept the risk of such loss or injury.

For Customer/Technical Support call (800) 747-1762

Notes:

Fantech reserves the right to make technical changes.
For updated documentation please refer to www.fantech.net

Fantech®