

PRODUCT SPECIFICATIONS

Fireclay 33" x 19-15/16" x 9-3/16" 60/40 Double Bowl Farmhouse Workstation Sink with Aqua Divide White. Sink is molded from fine fireclay with a durable porcelain glaze providing a finish that is non-porous and resists staining. Naturally sound deadening and Center drain placement.

Installation Type:	Farmhouse, Sink Kits
Material:	Fireclay
Special Features:	Aqua Divide Workstation
Finish:	White (WH)
Number of Bowls:	2
Sink Dimensions:	33" x 19-15/16" x 10-1/8"
Bowl 1 Dimensions:	12" x 16-1/4" x 9-3/16"
Bowl 2 Dimensions:	18-3/8" x 16-1/4" x 9-1/8"
Drain Size:	3-1/2" (89mm)
Drain Location:	Center
Minimum Cabinet Size:	36"
Template Included:	No

Special Note: Sink is reversible offering the option of a traditional flat front or a decorative band feature.



Included with Product: one LKCB1217HW cutting board.

A Century of Tradition and Quality. For more than 100 years, Elkay has been making innovative products and providing exceptional customer care. We take pride in offering plumbing products that make life easier, inspire change and leave the world a better place.



Product Compliance: ASME A112.19.2/CSA B45.1

Sinks are listed by IAPMO[®] as meeting the applicable requirements of the Uniform Plumbing Code[®], International Plumbing Code[®], and National Plumbing Code of Canada.

[Clean and Care Manual \(PDF\)](#)
[Installation Instructions \(PDF\) - 100003608](#)
[Warranty \(PDF\)](#)

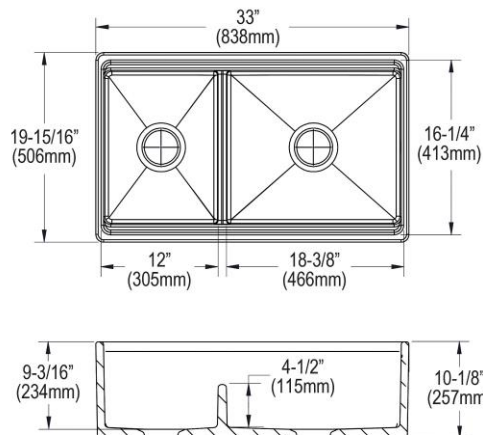
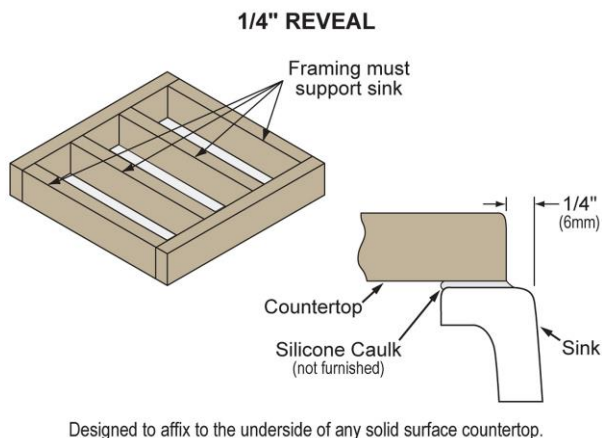

Installation Profile:



PART: _____ QTY: _____
 PROJECT: _____
 CONTACT: _____
 DATE: _____
 NOTES: _____
 APPROVAL: _____

Included Accessories

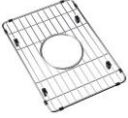
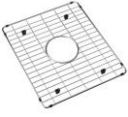
In keeping with our policy of continuing product improvement, Elkay reserves the right to change product specifications without notice. Please visit elkay.com for the most current version of Elkay product specification sheets. This specification describes an Elkay product with design, quality, and functional benefits to the user. When making a comparison of other producers' offerings, be certain these features are not overlooked.

LKCB1217HW	Elkay Hardwood 12-1/2" x 17-3/8" x 1-1/2" Cutting Board Spec Sheet (PDF)	
Optional Accessories		
LKBG1115SS	Elkay Stainless Steel 10-7/16" x 14-9/16" x 1-5/16" Bottom Grid Spec Sheet (PDF)	
LKBG1715SS	Elkay Stainless Steel 16-3/4" x 14-9/16" x 1-5/16" Bottom Grid Spec Sheet (PDF)	
LK99FC	Elkay® Deluxe Drain 3-1/2" Type 304 Stainless Steel Body for Fireclay Sinks Spec Sheet (PDF)	
LKEC2037	Elkay Explore Three Hole Bridge Faucet with Pull-down Spray and Lever Handles Spec Sheet (PDF)	

In keeping with our policy of continuing product improvement, Elkay reserves the right to change product specifications without notice. Please visit elkay.com for the most current version of Elkay product specification sheets. This specification describes an Elkay product with design, quality, and functional benefits to the user. When making a comparison of other producers' offerings, be certain these features are not overlooked.