

PRODUCT SPECIFICATIONS

Single Level Filter Maintenance Kit with Filter. Overall dimensions are 17-9/16" x 13-3/4" x 10-9/16".

Special Features:	Filtered
Mounting Type:	Wall Mount (On Wall)
Finish:	Stainless Steel
Dimensions:	17-9/16" x 13-3/4" x 10-9/16"
Shipping Weight:	8 lbs.
Flow Rate:	1.5 GPM (5.6 L/m)
Capacity:	
Temperature:	40-100°F (4-38°C)
Initial Pressure Drop:	2-5 PSI (14-34 kPa)
Maximum Pressure:	105 PSI (724 kPa)
Minimum Pressure:	20 PSI (138 kPa)
Water Inlet:	3/8" (9.5mm) O.D. tube
Water Outlet:	1/4" (6.4mm) O.D. tube

Special Note: Compatible with single-level EZ / LZ filtered models only and 36 in. of space on left side of drinking water unit provides sufficient access to conduct filter replacement.

- Cooler side panel provides convenient access to filter, water shut-off valve, and power supply without removing entire wrapper
- Two alignment pins on the panel make it easy to attach
- At least 36 in. of space on left side of drinking water unit is recommended
- Retrofit kit is compatible with Elkay® EZ/LZ single-level filtered coolers and bottle filling stations
- WaterSentry® 51300C 3,000-gallon filter is tested and certified to NSF 42 and 53 for the reduction of lead, Class 1 particulate, chlorine taste and odor
- Kit includes cooler wrapper with side access panel, 51300C water filter, security Torx bit and screws



Included with Product: One stainless steel wrapper with side access panel (for single level stations) and filter

A Century of Tradition and Quality.

For more than 100 years, Elkay has been making innovative products and providing exceptional customer care. We take pride in offering plumbing products that make life easier, inspire change and leave the world a better place.

[Installation Instructions \(PDF\) - 200000888](#)

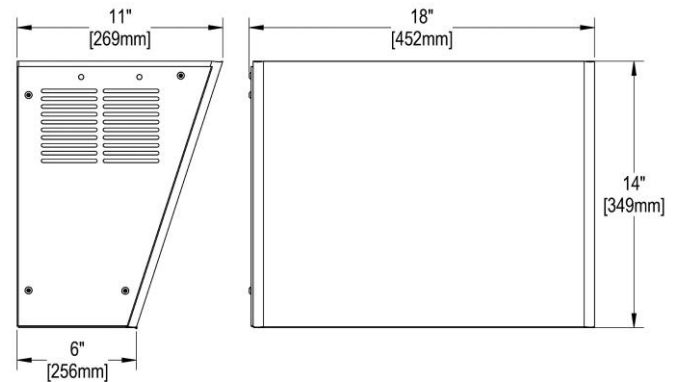

PART: _____ QTY: _____

PROJECT: _____

CONTACT: _____

DATE: _____

NOTES: _____

APPROVAL: _____

In keeping with our policy of continuing product improvement, Elkay reserves the right to change product specifications without notice. Please visit elkay.com for the most current version of Elkay product specification sheets. This specification describes an Elkay product with design, quality, and functional benefits to the user. When making a comparison of other producers' offerings, be certain these features are not overlooked.