

PRODUCT SPECIFICATIONS

Crosstown® 18 Gauge Stainless Steel 31-1/2" x 18-1/2" x 9" Single Bowl Undermount Sink. Sink is manufactured from 18 gauge 304 Stainless Steel with a Polished Satin finish, Rear Right drain placement, and Full spray sides and bottom with Sides and Bottom pads.

| | |
|------------------------------|--|
| Installation Type: | Undermount |
| Material: | 304 Stainless Steel |
| Finish: | Polished Satin |
| Gauge: | 18 |
| Sound Deadening: | Full spray sides and bottom with Sides and Bottom pads |
| Number of Bowls: | 1 |
| Sink Dimensions: | 31-1/2" x 18-1/2" x 9" |
| Bowl 1 Dimensions: | 30" x 17" x 9" |
| Drain Size: | 3-1/2" (89mm) |
| Drain Location: | Rear Right |
| Minimum Cabinet Size: | 36" |
| Mounting Hardware: | Part # 54300008 included |
| Template Included: | Yes |
| Cutout Template #: | 1000001381 |

Template is available for download at elkay.com. CAD software will be required to open the template.

Cutout Dimensions for Drop-in Installation:

29-3/4" x 16-3/4" (756mm x 425mm) with 7/16" (12mm) corner radius

Installation Profile:

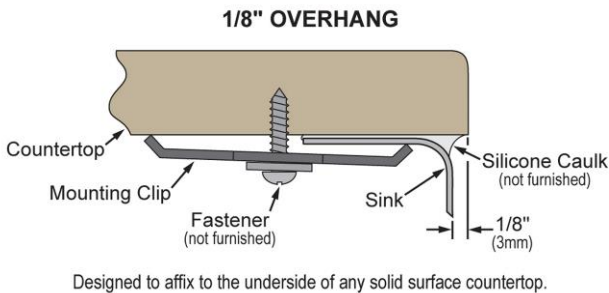

Designed to affix to the underside of any solid surface countertop.



A Century of Tradition and Quality. For more than 100 years, Elkay has been making innovative products and providing exceptional customer care. We take pride in offering plumbing products that make life easier, inspire change and leave the world a better place.



Product Compliance: ASME A112.19.3/CSA B45.4



Sinks are listed by IAPMO® as meeting the applicable requirements of the Uniform Plumbing Code®, International Plumbing Code®, and National Plumbing Code of Canada.

[Clean and Care Manual \(PDF\)](#)
[Installation Instructions \(PDF\) - 1000005239](#)
[Warranty \(PDF\)](#)

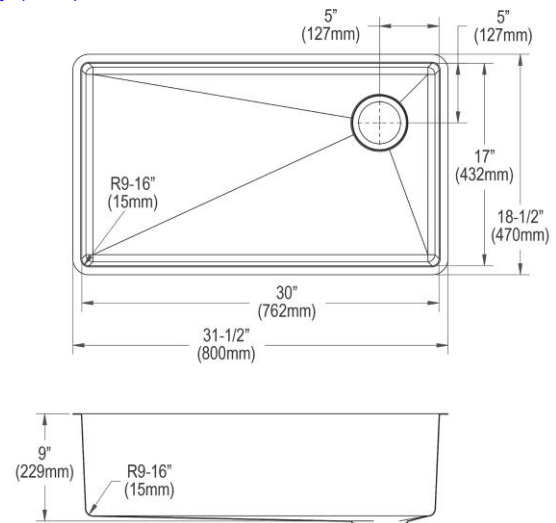

PART: _____ QTY: _____

PROJECT: _____







CONTACT: _____

DATE: _____

NOTES: _____

APPROVAL: _____

In keeping with our policy of continuing product improvement, Elkay reserves the right to change product specifications without notice. Please visit elkay.com for the most current version of Elkay product specification sheets. This specification describes an Elkay product with design, quality, and functional benefits to the user. When making a comparison of other producers' offerings, be certain these features are not overlooked.

| Optional Accessories | | |
|---------------------------|---|---|
| CTXBG2815 | Elkay Crosstown Stainless Steel 28-1/2" x 15-1/2" x 1-1/4" Bottom Grid Spec Sheet (PDF) |  |
| LK35 | 3-1/2" Drain Fitting Type 304 Stainless Steel Body Strainer Basket and Tailpiece Spec Sheet (PDF) |  |
| LKDD | Elkay® 3-1/2" Drain Fitting Deep Strainer Basket Spec Sheet (PDF) |  |
| LK3000CR | Everyday Kitchen Deck Mount Faucet with Remote Lever Handle Chrome Spec Sheet (PDF) |  |
| LK3001CR | Everyday Kitchen Deck Mount Faucet with Remote Lever Handle and Side Spray Chrome Spec Sheet (PDF) |  |
| LK5000 | Elkay Everyday Single Hole Deck Mount Kitchen Faucet with Pull-out Spray Lever Handle + Optional Escutcheon Spec Sheet (PDF) |  |
| LK6000 | Elkay Everyday Single Hole Deck Mount Kitchen Faucet with Pull-down Spray Forward Only Lever Handle Spec Sheet (PDF) |  |

In keeping with our policy of continuing product improvement, Elkay reserves the right to change product specifications without notice. Please visit elkay.com for the most current version of Elkay product specification sheets. This specification describes an Elkay product with design, quality, and functional benefits to the user. When making a comparison of other producers' offerings, be certain these features are not overlooked.