

**PRODUCT SPECIFICATIONS**

Dayton® Stainless Steel 33" x 22" x 8" Equal Double Bowl Dual Mount Sink. Sink is manufactured from 18 gauge 300 series Stainless Steel with a , Premium Highlighted Satin finish, Rear Center drain placement, and Bottom only pads.

<b>Installation Type:</b>	Drop-in, Undermount
<b>Material:</b>	300 series Stainless Steel
<b>Special Features:</b>	Slim Rim
<b>Finish:</b>	, Premium Highlighted Satin
<b>Gauge:</b>	18
<b>Sound Deadening:</b>	Bottom only pads
<b>Number of Bowls:</b>	2
<b>Sink Dimensions:</b>	33" x 22" x 8"
<b>Bowl 1 Dimensions:</b>	14-1/2" x 18-5/16" x 8"
<b>Bowl 2 Dimensions:</b>	14-1/2" x 18-5/16" x 8"
<b>Drain Size:</b>	3-1/2" (89mm)
<b>Drain Location:</b>	Rear Center
<b>Minimum Cabinet Size:</b>	36"
<b>Mounting Hardware:</b>	Part # 64090012 included for drop-in installation for countertops up to 3/4" (19mm) thick.
<b>Template Included:</b>	No
<b>Cutout Template #:</b>	<a href="#">1000000358</a>

Template is available for download at [elkay.com](#). CAD software will be required to open the template.

**Cutout Dimensions for Drop-in Installation:**

32-3/8" x 21-3/8" (822mm x 543mm) with 1-1/2" (38mm) corner radius

**Hole Drilling Configurations:**

1-1/2" (38mm) Diameter Faucet Holes

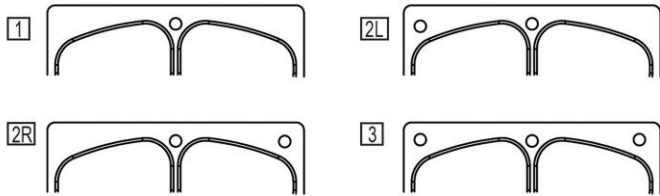

**A Century of Tradition and Quality.**

For more than 100 years, Elkay has been making innovative products and providing exceptional customer care. We take pride in offering plumbing products that make life easier, inspire change and leave the world a better place.



**Product Compliance:** ASME A112.19.3/CSA B45.4



Sinks are listed by IAPMO® as meeting the applicable requirements of the Uniform Plumbing Code®, International Plumbing Code®, and National Plumbing Code of Canada.

[Clean and Care Manual \(PDF\)](#)

[Installation Instructions \(PDF\) - 1000005237](#)

[Warranty \(PDF\)](#)

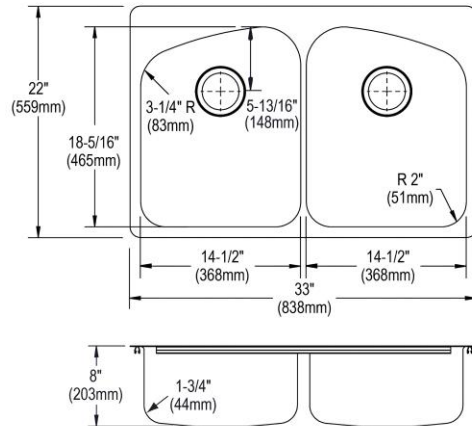

PART: \_\_\_\_\_ QTY: \_\_\_\_\_

PROJECT: \_\_\_\_\_

CONTACT: \_\_\_\_\_

DATE: \_\_\_\_\_

NOTES: \_\_\_\_\_





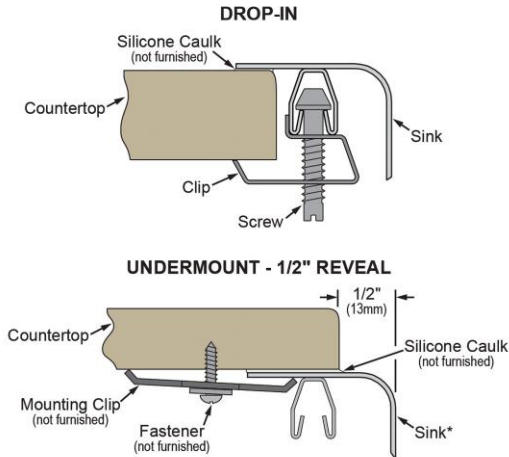

APPROVAL: \_\_\_\_\_

In keeping with our policy of continuing product improvement, Elkay reserves the right to change product specifications without notice. Please visit [elkay.com](#) for the most current version of Elkay product specification sheets. This specification describes an Elkay product with design, quality, and functional benefits to the user. When making a comparison of other producers' offerings, be certain these features are not overlooked.

**Installation Profile:**



\*Designed to affix to the underside of any solid surface countertop.

Optional Accessories		
<a href="#">GOBG1520LSS</a>	Dayton <sup>®</sup> Stainless Steel 13-1/4" x 17-1/16" x 1" Bottom Grid <a href="#">Spec Sheet (PDF)</a>	
<a href="#">GOBG1520RSS</a>	Dayton <sup>®</sup> Stainless Steel 13-1/4" x 17-1/16" x 1" Bottom Grid <a href="#">Spec Sheet (PDF)</a>	
<a href="#">LKCB1520LTHW</a>	Elkay Hardwood 12" x 19-3/4" x 1" Cutting Board - (Top mount installation) <a href="#">Spec Sheet (PDF)</a>	
<a href="#">LKCB1520LUHW</a>	Elkay Hardwood 12" x 20-11/16" x 1" Cutting Board - (Undermount installation) <a href="#">Spec Sheet (PDF)</a>	
<a href="#">D1125</a>	Dayton <sup>®</sup> 3-1/2" Stainless Steel Drain with Removable Basket Strainer and Rubber Stopper <a href="#">Spec Sheet (PDF)</a>	
<a href="#">LKWERBSS</a>	Elkay <sup>®</sup> Stainless Steel 15-3/8" x 12-3/8" x 5-7/16" Rinsing Basket <a href="#">Spec Sheet (PDF)</a>	

In keeping with our policy of continuing product improvement, Elkay reserves the right to change product specifications without notice. Please visit [elkay.com](http://elkay.com) for the most current version of Elkay product specification sheets. This specification describes an Elkay product with design, quality, and functional benefits to the user. When making a comparison of other producers' offerings, be certain these features are not overlooked.