

Part No.	Reference No.	Quantity	Description
0000136330~S	*		GENERAL ASSEMBLY
0000136329~S	*		MODEL NUMBER DESCRIPTION

Part No.	Reference No.	Quantity	Description
0000020758~P	*		GENERAL ASSEMBLY

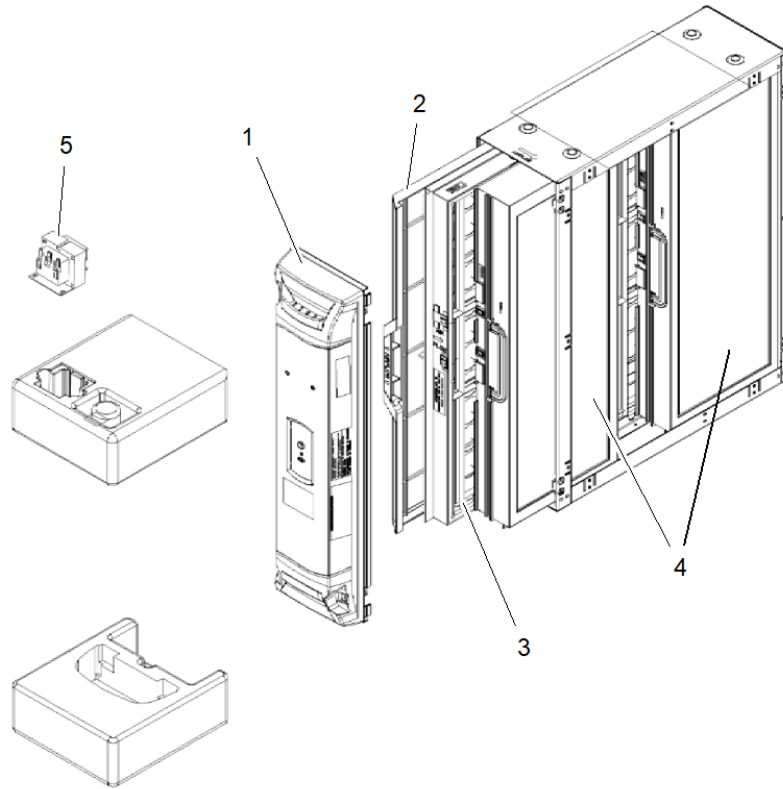

Part No.	Reference No.	Quantity	Description
CAB01157	*	1	CABLE; POWER CONTROL, (2 X 3 PLUG WITH THERMOSTAT WIRE)
CNT06888	*	1	CONTROL; PCB ASSEMBLY, ACCE MAIN BOARD, 3.50 X 3.12
FUS01349	*	1	FUSE; 3A FLAT BLADE, ATC-3 (5EA/CASE)
GKT05089	*	1	GASKET; ACCE
GKT05090	*	1	GASKET; GAS-COLLECTING COVER
KIT19209	*	1	KIT; ASM DOOR SHELL - 24.5IN, (CONSISTS OF OUTER HOUSING ASSY, LATCH, KEEPER, 2-WASHERS, WARNING LABEL, IFD LOGO LABEL, & ENVIROWISE/TRANE/AMER STD LO
KIT19223	*	1	KIT; LATCH ASSEMBLY (CONSISTS OF 4-LATCHES, 4-KEEPERS, 16-SCREWS)
KIT19269	*	1	KIT; ENVIROWISE/TRANE/AMER STD LOGO LABELS AND IFD LABEL
KIT19772	*	1	KIT; MOUNTING
KIT19220	1	1	KIT; DOOR ASM-IFD - 24.5 IN
FLR06466	2	1	FILTER; PRE-FILTER, 24.19 LONG X 26.07 WIDE
CHG00061	3	1	CHARGER; FIELD CHARGER ASSEMBLY, 24.3 X 26.3
FLR06455	4	1	FILTER; IFD-FILTER ASSEMBLY (PACKAGE OF 2 FILTERS) (COLLECTION CELL)
TRR02067	5	1	TRANSFORMER; 115V PRI, 24V SEC, 60 HZ, 50 VA

Part No.	Reference No.	Quantity	Description
0000020756~P	*		MODEL NUMBER DESCRIPTION

MODEL NOMENCLATURE

75014267

REV
A

Whole House Air Cleaner Units

Example Model Number:

E F D 1 4 5 D L F R 0 0 0 A A
1 5 10 15

Digit 1 Brand

T = Trane
 V = America Standard
 E = Envirowise

Digit 2 Accessory Type

F = Filtration

Digit 3 Accessory Type

D = IFD

Digit 4-6 Model Series

145 = Model Series Dimension
 14D = Model Series Dimension Downflow
 175 = Model Series Dimension
 17D = Model Series Dimension Downflow
 210 = Model Series Dimension
 21D = Model Series Dimension Downflow
 245 = Model Series Dimension
 24D = Model Series Dimension Downflow
 215 = Model Series Dimension
 235 = Model Series Dimension
 260 = Model Series Dimension

Digit 7 Equipment Application

A = Major Design Series

Digit 8 Equipment Application

L = Power Supply L (Low Voltage)

Digit 9-10 Major Modification & Voltage

FR = Furnace
 AH = Air Handler

Digit 11-13 Major Modification & Voltage

000 = Not use

Digit 14 Minor Modification

A = Minor Design

Digit 15 Service Digit

A = Service Digit A,B,C, etc.

Models

14.5" Furnace	E F D 1 4 5 D L F R 0 0 0 A A
17.5" Furnace	E F D 1 7 5 D L F R 0 0 0 A A
17.5" Furnace Downflow	E F D 1 7 D D L F R 0 0 0 A A
21" Furnace	E F D 2 1 D D L F R 0 0 0 A A
21" Furnace Downflow	E F D 2 1 5 D L A H 0 0 0 A A
24.5" Furnace	E F D 2 3 5 D L A H 0 0 0 A A
24.5" Furnace Downflow	E F D 2 4 5 D L F R 0 0 0 A A
21.5" Air Handler	E F D 2 6 0 D L A H 0 0 0 A A
23.5" Air Handler	E F D 1 7 5 D L A H 0 0 0 A A
26" Air Handler	E F D 2 1 0 D L F R 0 0 0 A A

