

Part No.	Reference No.	Quantity	Description
0000189273~S	*		General Assembly
0000189272~S	*		Model Number Description

Part No.	Reference No.	Quantity	Description
0000042609~P	*		General Assembly

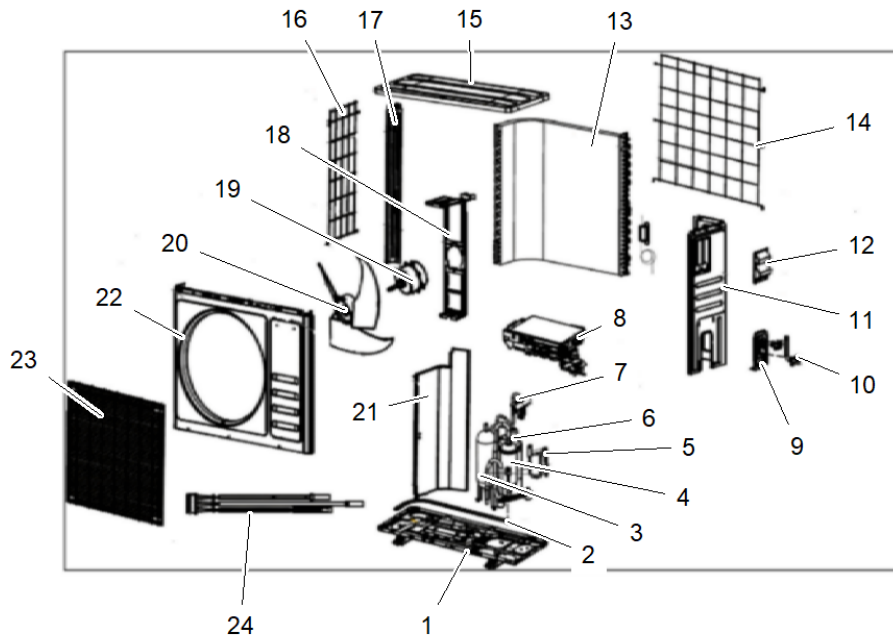

All orderable Service Parts are identified for this product.
Parts that are not identified, will not be available to order.
This is a typical illustration. The unit in the field may not appear exactly as shown.

Part No.	Reference No.	Quantity	Description
BOX04657	*	1	BOX; BOTTOM SHIPPING CARTON
CBT01950	*	1	CABINET; SHIPPING CARTON
COV06301	*	1	COVER; PACKAGING FOAM
INS03948	*	1	INSULATION; BOTTOM PACKAGING FOAM
PAN04512	1	1	PAN; BASE
HTR72144	2	1	HEATER; BASE PAN HEATER ASSEMBLY
ACC00384	3	1	ACCUMULATOR;
COM14142	4	1	COMPRESSOR; ASM
VAL20707	5	1	VALVE; HIGH PRESSURE ASSEMBLY
TUB16246	6	1	TUBE; SUCTION ASSEMBLY
VAL20710	7	1	VALVE; SWITCHOVER ASSEMBLY
CNT09444	8	1	CONTROL; OUTDOOR PCB ASSEMBLY
BRK05482	9	1	BRACKET; VALVE
VAL20712	10	1	VALVE; SERVICE ASSEMBLY
PNL39790	11	1	PANEL; ACCESS
COV06296	12	1	COVER; CONTROL
COL32353	13	1	COIL;
GRL02391	14	1	GRILLE; BACK WIRE
COV06297	15	1	COVER; TOP
GRL02392	16	1	GRILLE; SIDE WIRE
SUP07107	17	1	SUPPORT; CORNER POST
BRK05485	18	1	BRACKET; MOTOR
FAN06783	19	1	FAN; MOTOR
FAN06780	20	1	FAN; FAN
PLT07461	21	1	PLATE; PARTITIAN
PNL39791	22	1	PANEL; FRONT
GRL02394	23	1	GRILLE; FAN
SEN03191	24	1	SENSOR; OUTDOOR TEMP. ASSEMBLY

Part No.	Reference No.	Quantity	Description
0000042607~P	*		Model Number Description

MODEL NUMBER DESCRIPTION

75015602

REV
A

Example Model Number:
E4HL5018A1000AA
1 - - - 5 - - - - 10 - - - - 15

Digit 1 – Brand Name

A = RunTru by Trane
E = RunTru

Digit 2 - Refrigerant Type

4 = R410A

Digit 3,4 – Product Family

AC = Air Condition
HP = Heat Pump
HL = Side Discharge

Digit 5 – Nominal Efficiency Rating

4 = 14.3 SEER2
5 = 15.2 SEER2

Digit 6,7,8 – Nominal Capacity

BTU/HOUR x 1000

Digit 9 – Major Development Sequence

Primary Design / Form Series
Alphabetic Character "A" through "Z"

Digit 10 – Electric Power Supply Characteristics

1 = 200-230V/1PH/60HZ or 208-230V/1PH/60HZ

Digit 11,12,13 – Secondary Function

000 = No Secondary Function

Digit 14,15 – Minor Development Sequence/Series Design Change

Alphabetic Character "A" through "Z"

