



SERIES

Built to FIT. Designed to deliver.



fantech[®]

a systemair company



FIT® SERIES

Balanced Ventilation for Multi-Family Living

Designed for multi-family applications, the FIT® Series fresh air appliance with energy recovery (ERV) delivers efficient, code-compliant ventilation in a compact, low-profile design.

With an airflow capacity of up to 129 CFM at 0.4" w.g., this energy recovery ventilator ensures fresh air supply while transferring heat and moisture for year-round comfort and efficiency.

The FIT® Series is built for flexibility, offering both hardwired and corded versions to meet installation preferences. Its slim profile and ceiling bracket make mounting easy, even in tight spaces. The energy recovery core optimizes heating and cooling efficiency by transferring heat and moisture between incoming and outgoing air.

For multi-family projects where space is at a premium but performance is non-negotiable, the FIT® Series is the right choice.

Built to FIT. Designed to deliver.



What Does this Mean for You:



Enhanced Flexibility: Ideal for mirrored floor-plans and code requiring hard-connect options.



Slim Profile: The compact design allows for clean installation in tight spaces with minimal footprint.



Greater Efficacy: Greater airflow with less energy consumption.



Enhanced IAQ Solutions: Meets HVI and CSA requirements.



Key Features of the FIT Series

Energy Efficiency
up to 77% SRE at 32°F/0°C

Easy Installation & Maintenance

CSI & HVI Certified

MERV3 filter (included)
MERV8 and MERV13 Filters (optional)









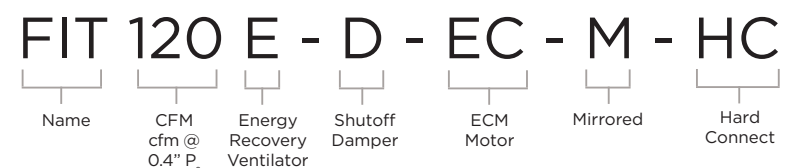

Side-Port Connections

Fan Efficacy
up to 2.2 cfm/W

FIT[®] SERIES PRODUCT LINE

What's in the name?



Model		FIT [®] 80E ²	FIT [®] 80E-D ²	FIT [®] 120E ²	FIT [®] 120E-D ²	FIT [®] 120E-D-EC ²
R Easy to specify BIM objects & CSI specs available on product page						
Airflow range (Low/ High speed)	cfm @ 0.4" wg	36-78	36-78	40-127	40-127	40-129
Duct connection	inch	4	4	5	5	5
Voltage / Phase	V / -	120/1	120/1	120/1	120/1	120/1
Duct type		Round	Round	Round	Round	Round
Consumed power (Low / High speed)	W	42/52	42/52	45/120	45/120	23/147
Fan Efficacy @ 0°C/32°F	cfm/W	1.5	1.5	1.2	1.2	2.2
Adjusted Sensible Recovery Efficiency @ 0°C/32°F	%	75	75	81	81	80
Sensible Recovery Efficiency @ 0°C/32°F ¹	%	70	70	74	74	77
Sensible Recovery Efficiency @ -25°C/-13°F ¹	%	55	55	61	61	61
Total Recovery Efficiency @ 35°C/95°F ¹	%	50	50	64	64	70
Max current	A	0.6	0.6	1.4	1.4	3
Certifications						
Defrost cycle		Fan Shutdown	Fan Shutdown	Fan Shutdown	Fan Shutdown	Fan Shutdown
Depth	inch (mm)	20 5/8 (523)	20 5/8 (523)	23 5/32 (588)	23 5/32 (588)	23 5/32 (588)
Width	inch (mm)	21 5/8 (549)	21 7/8 (556)	24 5/8 (625)	25 1/16 (636)	25 1/16 (636)
Height	inch (mm)	10 1/6 (255)	10 1/6 (255)	10 (254)	10 (254)	10 (254)
Weight	lbs (Kg)	29 (13)	30 (13)	34 (15)	35 (16)	35 (16)

¹Performance at low speed. ² Standard has fresh air supply on the right; Mirrored has fresh air supply on the left.

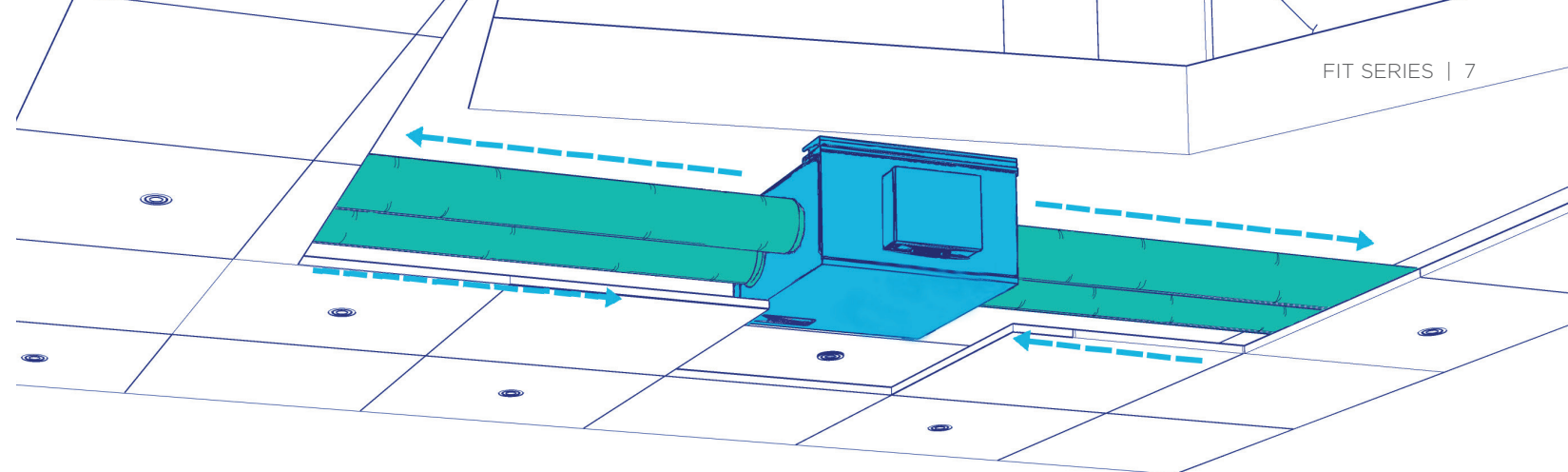

Creating Healthy IAQ



FIT ERV
bring in fresh air, remove stale air; air tempered by outgoing air

ECO-Feel IAQ
increases ventilation based on TVOCs

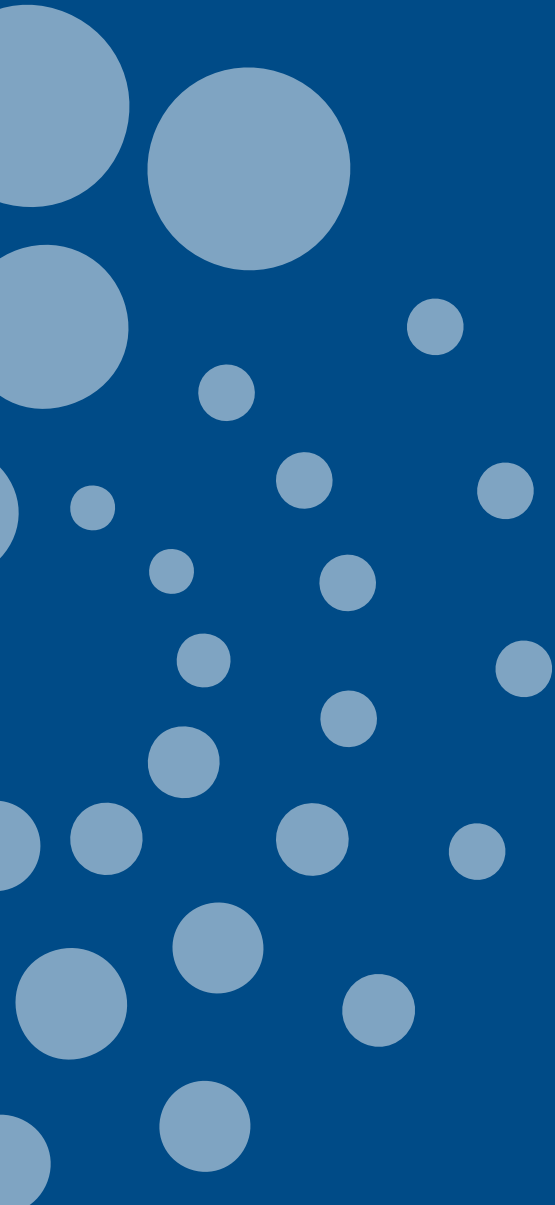

Customer Support:

USA 800.747.1762 • USsupport@fantech.net

CANADA 800.565.3548 • CANADAsupport@fantech.net

Distributed Locally by:



Systemair Inc. reserves the right to modify, at any time and without notice, any or all of its products' features, designs, components and specifications to maintain their technological leadership position. The application rendering presented in this brochure is for a visual presentation purpose only. Please, contact a professional for technical guidance.

Zephyr Creative • March 2025 • E1993