

SpeediChannel[®]

PRODUCT

SpeediChannel[®]

APPLICATION

Cover system for air conditioning linesets

PURPOSE

SpeediChannel[®] is a system used to cover linesets, drain lines, and control cables when they can not be installed inside a wall.

COMPOSITION

U.V. inhibited virgin resin

ADVANTAGES

SpeediChannel[®] is an innovative channel system used to cover air conditioning linesets. The two-part system has a base and a cover. The base is fastened to a wall or ceiling, then with the use of SpeediClip™ that snaps onto the molded center rail of the channel, cable ties can easily secure the linesets. The cover then simply snaps on top of the base and is screwed in for extreme durability.

Available in three widths - 3", 4", and 6", each channel is 6-1/2' long and is part of a complete system including couplings, elbows, covers and tees.

Manufactured from rigid PVC, the SpeediChannel[®] system comes in three colors, Natural, White and Brown. The SpeediChannel[®] system can be painted as desired to match any wall color. The PVC used in the SpeediChannel[®] system is resistant to UV light. SpeediChannel[®] is easier to inventory, transport and install than competing brands, and the flat pack design reduces warehouse storage and contractor transport space. Tight fit corner design and installation accessories deliver the contractor a clean install every time.

COLORFAST STABILITY

The stability of the color on SpeediChannel[®] remains consistent after 5 years of external exposure. The contrast on the Grey scale according to ISO EN 105 A02 of the finished goods will not be below level 3, when compared to an unexposed control sample of the same grade. This statement is limited to the climate zones where the annual global irradiation is less than 100,000 Langleys: North American climate.

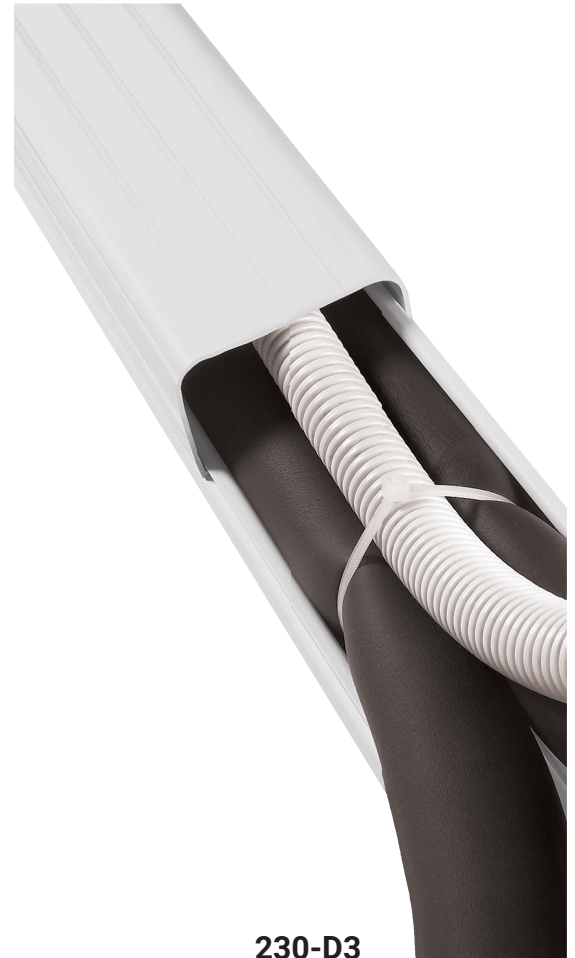

230-D3

SpeediChannel®

PAINTING SPECIFICATIONS

DiversiTech recommends any 100% acrylic latex or 100% acrylic latex with a urethane additive when painting SpeediChannel® products, due to the flexibility within the paint. Lacquers are not recommended with PVC products because lacquers are more brittle and won't flex with the channel. Some suggestions: Duration® by Sherwin Williams®, Manor Hall® paints by PPG, and Moorlife® by Benjamin Moore®. In addition to paint type, only light-to-medium colored paints (Light Reflectance Value of 55% units or greater) should be applied to SpeediChannel® or most any exterior PVC products. Light Reflectance Value (LRV) is a measurement that indicates how much light a color reflects. An LRV of 0% is absolute black and an LRV of 100% is perfectly reflective white. Always check a paint's LRV because some lighter paints may actually have a lower LRV than expected.

UNIQUE PIECES

Flex hose kit
 Flat wall escutcheon
 Integrated flex joint
 Long radius 90 flat elbow

HARDWARE

Stainless steel

SLEEVE STYLE

Single piece

SPECIFICATIONS

SpeediChannel - 6-1/2' Long Channel

Available in 3 widths
 Includes SpeediClips™

Size	Natural	Brown	White	A	B	C
3"	230-D3A	230-D3B	230-D3W	2.75 in.	2.55 in.	78.74 in.
4"	230-D4A	230-D4B	230-D4W	4.13 in.	2.75 in.	78.74 in.
6"	230-D6		230-D6W	5.90 in.	3.14 in.	78.74 in.

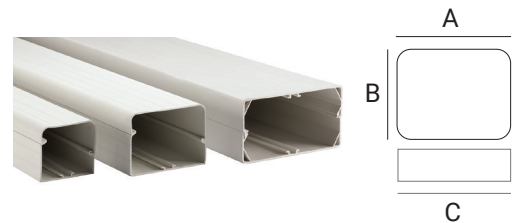

Wall Penetration

Size	Natural	Brown	White	A	B	C
3"	230-WC3	230-WC3B	230-WC3W	4.33 in.	7.08 in.	2.77 in.
4"	230-WC4	230-WC4B	230-WC4W	5.70 in.	7.48 in.	4.14 in.
6"	230-WC6		230-WC6W	6.29 in.	7.87 in.	5.92 in.

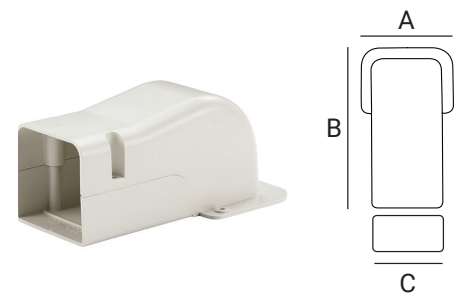

Wall Sleeve

Size	Natural	A	B	C
2-1/2"	230-WS2	3.80 in.	13.67 in.	2.44 in.

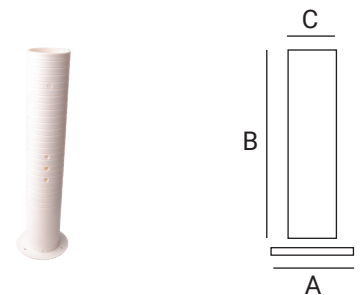

SpeediChannel®

Union Coupling

Size	Natural	Brown	White	A	B	C
3"	230-CP3	230-CP3B	230-CP3W	2.96 in.	2.77 in.	2.77 in.
4"	230-CP4	230-CP4B	230-CP4W	4.34 in.	3.16 in.	4.14 in.
6"	230-CP6		230-CP6W	6.11 in.	3.36 in.	5.92 in.

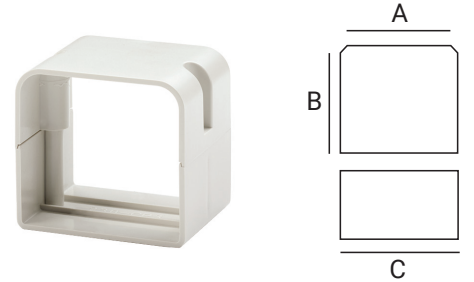

90° Long Radius Bend

Size	Natural	Brown	White	A	B	C
3"	230-LFB3	230-LFB3B	230-LFB3W	2.96 in.	2.77 in.	9.84 in.
4"	230-LFB4	230-LFB4B	230-LFB4W	4.34 in.	3.16 in.	9.84 in.
6"	230-LFB6		230-LFB6W	6.11 in.	3.36 in.	9.84 in.

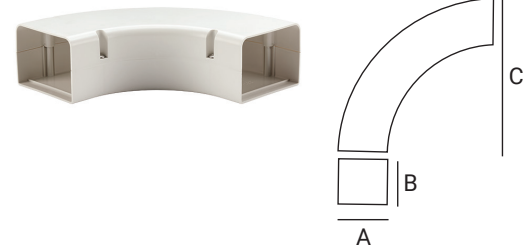

90° Flat Bend

Size	Natural	Brown	White	A	B	C
3"	230-FB3	230-FB3B	230-FB3W	4.33 in.	4.52 in.	2.77 in.
4"	230-FB4	230-FB4B	230-FB4W	5.90 in.	5.90 in.	4.14 in.
6"	230-FB6		230-FB6W	6.69 in.	6.69 in.	5.92 in.

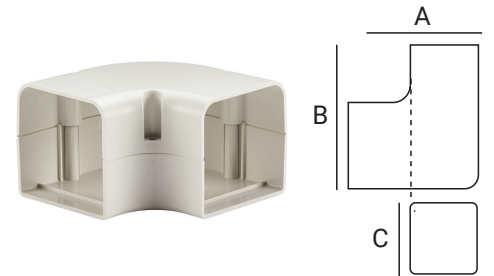

90° Inside Elbow

To place around the internal corner

Size	Natural	Brown	White	A	B	C
3"	230-EB3	230-EB3B	230-EB3W	3.74 in.	3.74 in.	2.70 in.
4"	230-EB4	230-EB4B	230-EB4W	4.33 in.	4.33 in.	4.14 in.
6"	230-EB6		230-EB6W	6.10 in.	6.10 in.	5.92 in.

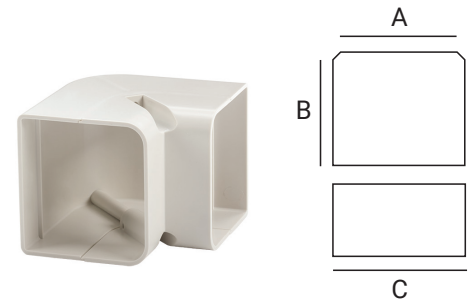

90° Outside Elbow

To place around the outside corner

Size	Natural	Brown	White	A	B	C
3"	230-EIN3	230-EIN3B	230-EIN3W	3.74 in.	3.74 in.	2.77 in.
4"	230-EIN4	230-EIN4B	230-EIN4W	4.33 in.	4.33 in.	4.14 in.
6"	230-EIN6		230-EIN6W	6.10 in.	6.10 in.	5.92 in.

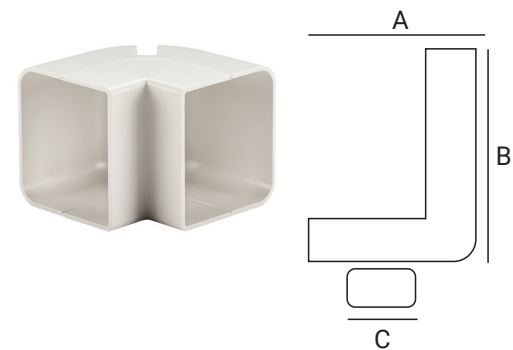

SpeediChannel®

45° Flat Bend

To place around an obstacle

Size	Natural	Brown	White	A	B	C
3"	230-FB453	230-FB453B	230-FB453W	3.64 in.	5.72 in.	2.77 in.
4"	230-FB454	230-FB454B	230-FB454W	3.64 in.	6.70 in.	4.14 in.
6"	230-FB456		230-FB456W	3.64 in.	7.49 in.	5.92 in.

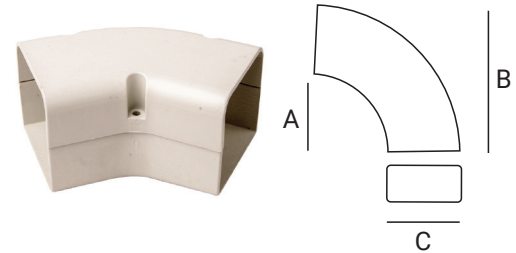

T-Joint

To create a tee connection between three pieces of SpeediChannel

Size	Natural	Brown	White	A	B	C
4"	230-TJ4	230-TJ4B	230-TJ4W	4.14 in.	4.14 in.	7.87 in.
6"	230-TJ6		230-TJ6W	5.92 in.	5.92 in.	9.84 in.

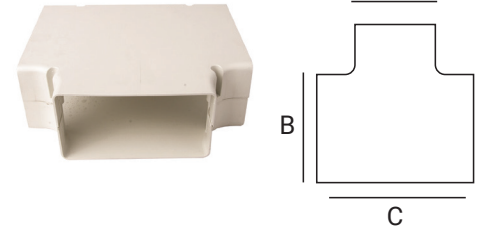

Reducer Coupling

To join two pieces of SpeediChannel

Size	Natural	Brown	White	A	B	C
3" x 4"	230-TC34		230-TC34W	4.14 in.	3.16 in.	2.77 in.
4" x 6"	230-TC46		230-TC46W	5.92 in.	6.11 in.	4.14 in.

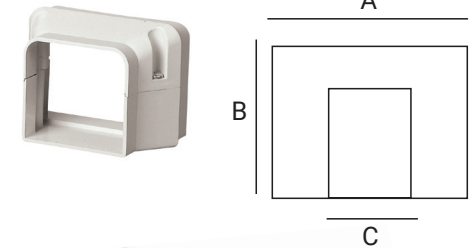

Flex Joint

Size	Natural	Brown	White	A	B	C
3"	230-FJ3			19.68 in.	2.55 in.	2.55 in.
4"	230-FJ4			19.68 in.	3.93 in.	3.93 in.

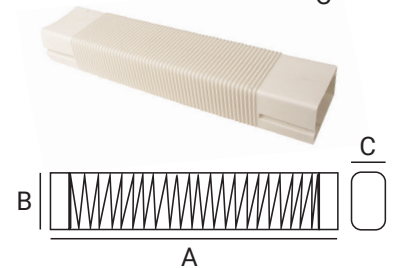

Duct End

To terminate a run of SpeediChannel to a small opening

Size	Natural	Brown	White	A	B	C
3"	230-DE3	230-DE3B	230-DE3W	4.72 in.	2.77 in.	1.77 in.
4"	230-DE4	230-DE4B	230-DE4W	4.72 in.	4.14 in.	1.96 in.
6"	230-DE6		230-DE6W	4.72 in.	5.92 in.	2.36 in.

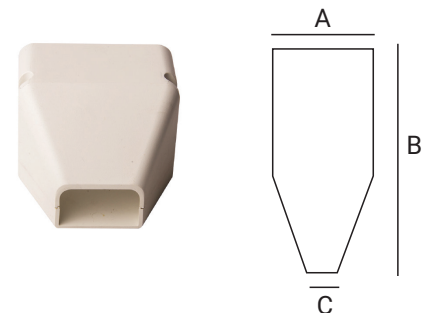

SpeediChannel®

Cap

To cap the end of the SpeediChannel

Size	Natural	Brown	White	A	B	C
3"	230-DC3		230-DC3W	2.75 in.	2.55 in.	
4"	230-DC4		230-DC4W	4.13 in.	2.95 in.	
6"	230-DC6		230-DC6W	5.90 in.	3.14 in.	

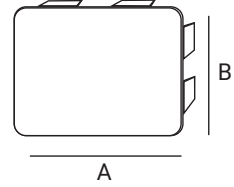
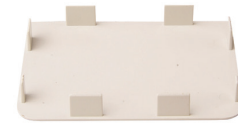

Flat Wall Escutcheon

To cover a rough opening in a soffit, wall, or ceiling penetration

Size	Natural	Brown	White	A	B	C
3"	230-FR3		230-FR3W	6.11 in.	3.54 in.	2.77 in.
4"	230-FR4		230-FR4W	5.92 in.	3.93 in.	4.14 in.
6"	230-FR6		230-FR6W	7.48 in.	4.33 in.	5.92 in.

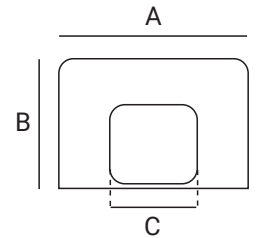
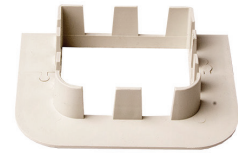

Wall Escutcheon

To cover a rough opening in a wall, or ceiling penetration

Size	Natural	Brown	White	A	B	C
3"	230-WR3		230-WR3W	4.54 in.	4.34 in.	2.77 in.
4"	230-WR4		230-WR4W	5.92 in.	4.74 in.	4.14 in.
6"	230-WR6		230-WR6W	7.48 in.	6.51 in.	5.92 in.

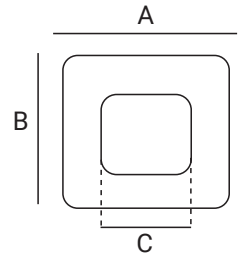

Soffit Fittings

Ideal for outdoor applications

Size	Natural	Brown	White	A	B	C
3"	230-SF3		230-SF3W	4.69 in.	4.84 in.	2.77 in.
4"	230-SF4		230-SF4W	6.07 in.	5.72 in.	4.14 in.

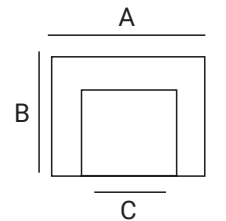

Adjustable Flat Bend

Flex from 45° to 90° degrees

Size	Natural	Brown	White	A	B	C
3"	230-AFB3		230-AFB3W	2.75 in.	2.60 in.	4.10 in.
4"	230-AFB4		230-AFB4W	4.12 in.	2.95 in.	5.28 in.

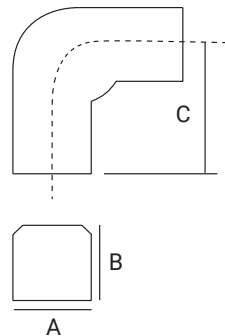

SpeediChannel®

Flex Hose Connection Kit

Size	Natural	Brown	White	A	B	C
3"	230-FH3-KIT		230-FH3W-KIT	39 in.	3 in.	
4"	230-FH4-KIT		230-FH4W-KIT	39 in.	4 in.	



SpeediChannel Installation Kits

Includes three 48 in. pieces of channel and selected fittings

Size	Natural	Brown	White
3"	230-IKC3		230-IKC3W
4"	230-IKC4		230-IKC4W

