Comfort-Aire®

Century®

MARS
Delivering Confidence

INSTALLATION MANUAL

Ceiling and Floor Unit

Models

B-VMH18UU-1

B-VMH24UU-1

CONTENTS

	PAGE
PRECAUTIONS.....	2
INSTALLATION INFORMATION.....	3
ATTACHED FITTINGS.....	4
INSPECTING AND HANDLING THE UNIT.....	5
INDOOR UNIT INSTALLATION.....	5
OUTDOOR UNIT INSTALLATION.....	7
CONNECT THE DRAIN PIPE.....	10
INSTALL THE CONNECTING PIPE.....	11
AIR EVACUATION.....	15
WIRING.....	16
TEST OPERATION.....	17

1. PRECAUTIONS

- **Keep this manual where the operator can easily find it.**
- **Read this manual carefully before starting the unit.**
- **For safety reasons the operator must read the following cautions carefully.**
- **Installation must be performed in accordance with the requirement of NEC and CEC by authorized personnel only. (Applicable to the North American area only)**

The safety precautions listed here are divided into two categories.



WARNING

If you do not follow these instructions exactly, the unit may cause property damage, personal injury or loss of life.



CAUTION

If you do not follow these instructions exactly, the unit may cause minor or moderate property damage, personal injury.

After completing the installation, make sure that the unit operates properly during the start-up operation. Please instruct the customer on how to operate the unit and keep it maintained. Also, inform customers that they should store this installation manual along with the owner's manual for future reference.



WARNING

Be sure only trained and qualified service personnel install, repair or service the equipment.

Improper installation, repair, and maintenance may result in electric shocks, short-circuit, leaks, fire or other damage to the equipment.

Install strictly according to this installation instruction.
If installation is defective, it will cause water leakage, electrical shock and fire.

When installing the unit in a small room, take measures to keep refrigerant concentration from exceeding allowable safety limits in the event of refrigerant leakage.
Contact the place of purchase for more information. Excessive refrigerant in a closed ambient can lead to oxygen deficiency.

Use the attached accessories parts and specified parts for installation.
otherwise, it will cause the set to fall, water leakage, electrical shock and fire.

Install in a strong and firm location which is able to withstand the set's weight.
If the strength is not enough or installation is not properly done, the set will fall and cause injury.

Before obtaining access to terminals, all supply circuits must be disconnected.

For electrical work, follow the local national wiring standard, regulation and these installation instructions. An independent circuit and single outlet must be used.
If electrical circuit capacity is not enough or there is a defect in electrical work, it will cause electrical shock fire.

Use the specified cable and connect tightly and clamp the cable so that no external force will be imposed on the terminal.
If connection is not perfect, it will cause heat-up or fire at the connection.

Wiring routing must be properly arranged so that control board cover is fixed properly.
If control board cover is not fixed perfectly, it will cause heat-up at connection point of terminal, fire or electrical shock.

If the supply cord is damaged, it must be replaced by the manufacturer or its service agent or a similarly qualified person in order to avoid a hazard.

When carrying out piping connections, take care not to let air substances go into refrigeration circuit.
Otherwise, it will cause lower capacity, abnormal high pressure in the refrigeration cycle, explosion and injury.

Do not modify the length of the power supply cord or use an extension cord, and do not share the single circuit with other electrical appliances.
Otherwise, it will cause fire or electrical shock.

Carry out the specified installation work after taking into account strong winds, typhoons or earthquakes. Improper installation work may result in the equipment falling and causing accidents.

If the refrigerant leaks during installation, ventilate the area immediately.
Toxic gas may be produced if the refrigerant comes into contact with fire.

The temperature of refrigerant circuit will be high, please keep the interconnection cable away from the copper tube.

After completing the installation work, check that the refrigerant does not leak.

Toxic gas may be produced if the refrigerant leaks into the room and comes into contact with a source of fire, such as a fan heater, stove or cooker.



CAUTION

Ground the air conditioner.

Do not connect the ground wire to gas or water pipes, lightning rod or a telephone ground wire. Inappropriate grounding may result in electric shocks.

Be sure to install an earth leakage breaker.

Failure to install an earth leakage breaker may result in electric shocks.

Connect the outdoor unit wires, then connect the indoor unit wires.

You are not allowed to connect the air conditioner with the power supply until the wiring and piping is done.

While following the instructions in this installation manual, install drain piping in order to ensure proper drainage and insulate piping in order to prevent condensation.

Improper drain piping may result in water leakage and property damage.

Install the indoor and outdoor units, power supply wiring and connecting wires should be at least 4 feet away from televisions or radios in order to prevent image interference or noise.

Depending on the radio waves, a distance of 4 feet may not be sufficient enough to eliminate the noise.

This appliance is not intended for use by young children or infirm persons without supervision.

Don't install the air conditioner in the following circumstances:

- There is petroleum present.
- There is salty air surrounding (near the coast).
- There is caustic gas (the sulfide, for example) existing in the air (near a hot spring).
- The voltage varies violently (in factories).
- In buses or cabinets.
- In kitchen where it is full of oil gas.
- There is strong electromagnetic wave existing.
- There are inflammable materials or gas.
- There is acid or alkaline liquid evaporating.
- Other special conditions.

The appliance shall be installed in accordance with national wiring regulations.

Do not operate your air conditioner in a wet room such as a bathroom or laundry room.

An all-pole disconnection device which has at least 3mm clearances in all poles, and has a leakage current that may exceed 10mA, the residual current device (RCD) having a rated residual operating current not exceeding 30mA, and disconnection must be incorporated in the fixed wiring in accordance with the wiring rules.

In cases where the outdoor unit is installed above the indoor unit, secure the taped piping along the exterior wall, form a trap to prevent water entering the room.

2. INSTALLATION INFORMATION









- To install properly, please read this "installation manual" first.
- The air conditioner must be installed by qualified persons.
- When installing the indoor unit or its tubing, please follow this manual as strictly as possible.
- If the air conditioner is installed on a metal part of the building, it must be electrically insulated according to the relevant standards to electrical appliances.
- When all the installation work is finished, please turn on the power only after a thorough check.

INSTALLATION ORDER

- Select the location;
- Install the indoor unit;
- Install the outdoor unit;
- Install the connecting pipe ;
- Connect the drain pipe;
- Wiring;
- Test operation.

3. ATTACHED FITTINGS

Please check whether the following fittings are of full scope. If there are some spare fittings , please restore them carefully.

	NAME	SHAPE	QUANTITY
Remote controller & Its Holder	1. Remote controller (on some models)		1
	2. Remote controller holder (on some models)		1
	3. Mounting screw(ST2.9×10-C-H)		2
	4. Alkaline dry batteries (AM4)		2
Others	5. Magnetic ring (on some models)		2
	6. connection wire of wired remote controller (on some models)		1
	7. Owner's manual		1
	8. Installation manual		1
	9. Remote controller manual		1

4. INSPECTING AND HANDLING THE UNIT

At delivery, the package should be checked and any damage should be reported immediately to the the service agent.

When handling the unit, take into account the following:

- 1 Fragile, handle the unit with care.
 Keep the unit upright in order to avoid compressor damage.
- 2 Choose beforehand the path along which the unit is to be brought in.
- 3 Move this unit in it's originally package as much as possible.
- 4 When lifting the unit , always use protectors to prevent belt damage and pay attention to the position of the unit's center of gravity.

5. INDOOR UNIT INSTALLATION

5.1 Installation location

(Refer to Fig.5-1, Fig.5-2 and Table 5-1 for specification.)

The indoor unit should be installed in a location that meets the following requirements:

- There is enough room for installation and maintenance.
- The ceiling is horizontal, and its structure can endure the weight of the indoor unit.
- The outlet and the inlet are not impeded, and the influence of external air is minimal.
- The air flow can reach throughout the room.
- The connecting pipe and drainpipe can be accessed easily.
- There is no direct radiation from heaters.

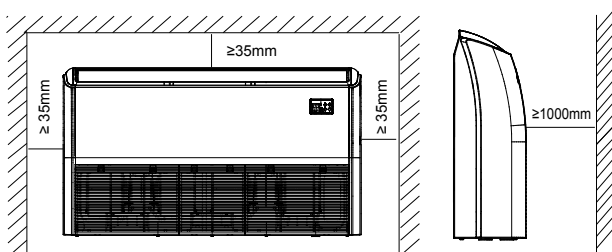

Fig.5-1



CAUTION

Keep indoor unit, outdoor unit, power supply wiring and transmission wiring at least 4 feet away from televisions and radios. This is to prevent image interference and noise in those electrical appliances. (Noise may be generated depending on the conditions under which the electric wave is generated, even if 4 feet is kept.)

5.2 Install the main body

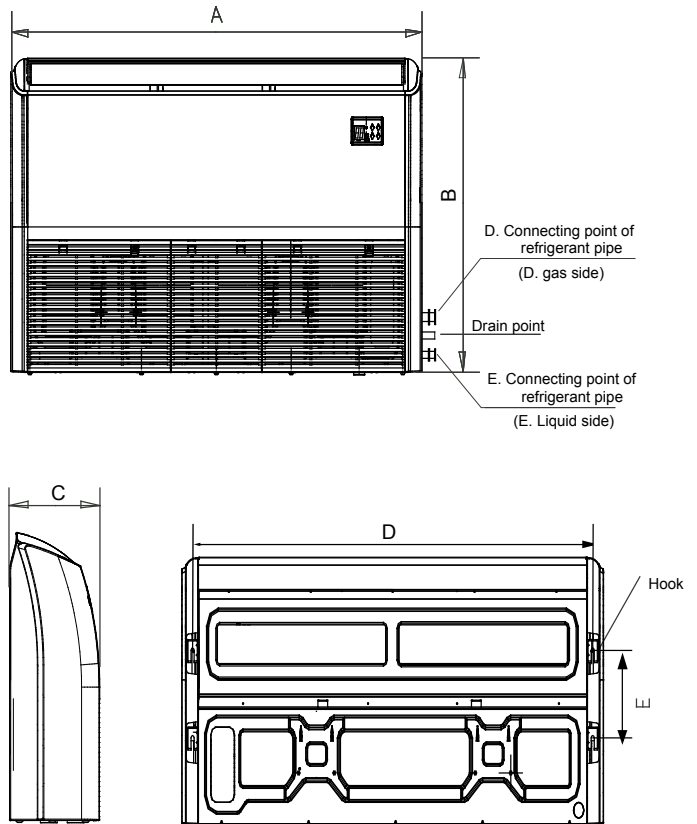

Fig. 5-2

1 Installing Ø10 hanging screw bolts. (4 bolts)

- Please Refer to Fig.5-3 and Fig.5-4 for the hanging screw bolts distance
- Evaluate the ceiling construction and please install with Ø10 hanging screw bolts.
- The handling to the ceiling varies from the constructions, consult the construction person for the specific condition.
 - Do keep the ceiling flat. Consolidate the roof beam to avoid possible vibration.
 - Cut off the roof beam.
 - Strengthen the place that has been cut off, and consolidate the roof beam.
- After the selection of installation location, position the refrigerant pipes, drain pipes, indoor & outdoor wires to the connection places before hanging the machine.
- The installation of hanging screw bolts.

WOODEN CONSTRUCTION

Put the square timber over the roof beam, then install the hanging screw bolts.

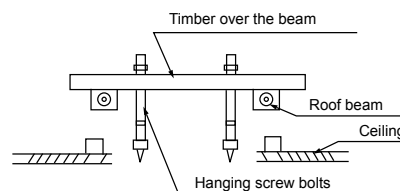

Fig. 5-3

NEW CONCRETE BRICKS

Inlaying or embedding the screw bolts.



Fig. 5-4

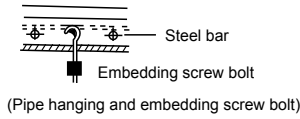

Fig. 5-5

- Locate the hanging arm on the hanging screw bolt. (Refer to Fig. 5-9)

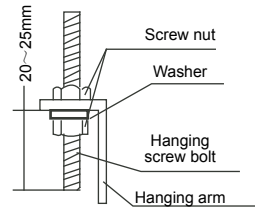

Fig. 5-9

FOR ORIGINAL CONCRETE BRICKS

Install the hanging hook with expandable bolt into the concrete at a depth of 1-3/4" to ~2" to prevent loosening.

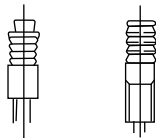

Fig. 5-6

STEEL ROOF BEAM STRUCTURE

Install and use directly the supporting angle steel.

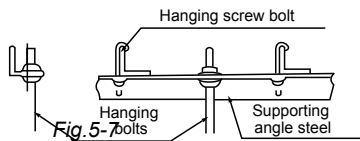

Fig. 5-7

2 Install the indoor unit.

- Remove the side board and the grille. (Refer to Fig. 5-8)

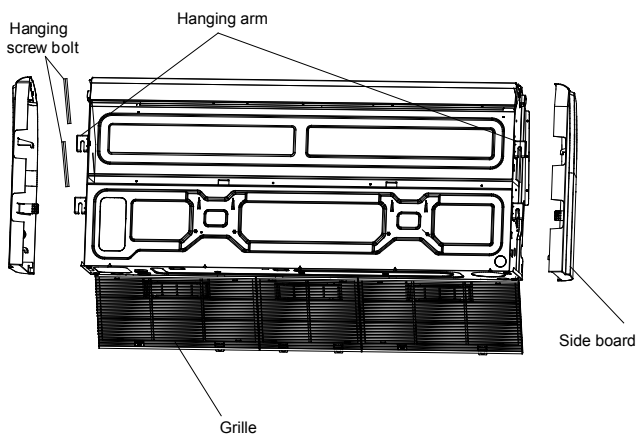

Fig. 5-8

3 Ceiling Installation

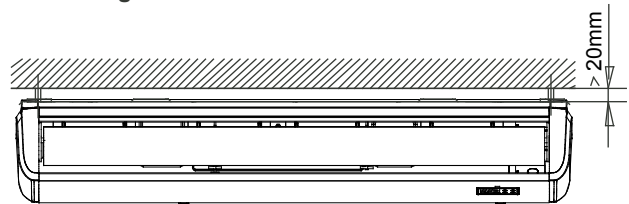

Fig. 5-10

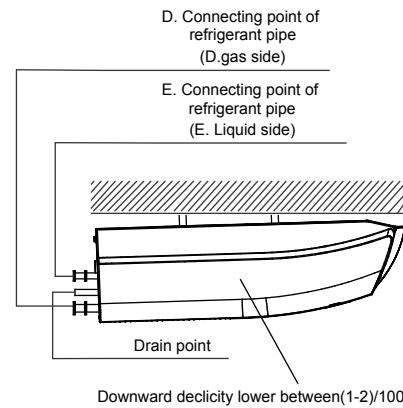

Fig. 5-11

4 Wall Mounting Installation

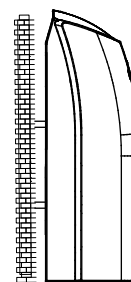

Fig. 5-12

6. OUTDOOR UNIT INSTALLATION

Outdoor Unit Installation Instructions

Step 1: Select installation location.

The outdoor unit should be installed in a location that meets the following requirements:

- ☑ Place the outdoor unit as close to the indoor unit as possible.
- ☑ Ensure that there is enough room for installation and maintenance.
- ☑ The air inlet and outlet must not be obstructed or exposed to strong wind.
- ☑ Ensure the location of the unit will not be subject to snowdrifts, accumulation of leaves or other seasonal debris. If possible, provide an awning for the unit. Ensure the awning does not obstruct airflow.
- ☑ The installation area must be dry and well ventilated.
- ☑ There must be enough room to install the connecting pipes and cables and to access them for maintenance.

- ☑ The area must be free of combustible gases and chemicals.
- ☑ The pipe length between the outdoor and indoor unit may not exceed the maximum allowable pipe length.
- ☑ If possible, **DO NOT** install the unit where it is exposed to direct sunlight.
- ☑ If possible, make sure the unit is located far away from your neighbors' property so that the noise from the unit will not disturb them.
- ☑ If the location is exposed to strong winds (for example: near a seaside), the unit must be placed against the wall to shelter it from the wind. If necessary, use an awning. (See Fig. 6.1 & 6.2)
- ☑ Install the indoor and outdoor units, cables and wires at least 4 feet from televisions or radios to prevent static or image distortion. Depending on the radio waves, a 4 feet distance may not be enough to eliminate all interference.

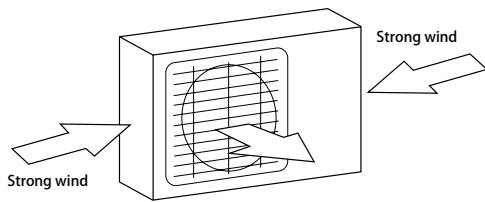

Fig. 6.1

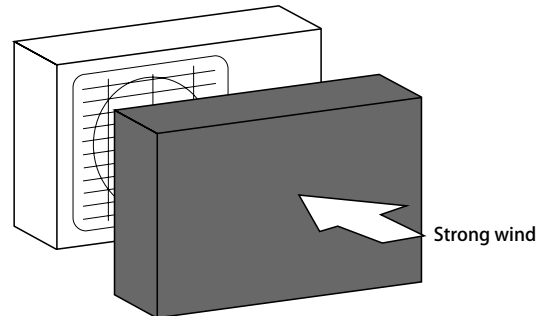

Fig. 6.2

Step 2: Install outdoor unit.

Fix the outdoor unit with anchor bolts (M10)

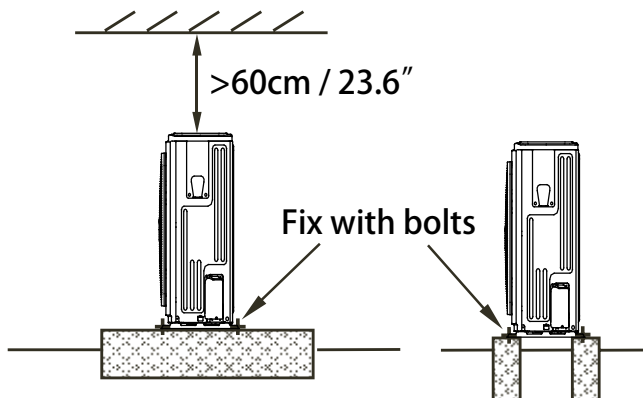

Fig. 6.3

! CAUTION

- Be sure to remove any obstacles that may block air circulation.
- Make sure you refer to Length Specifications to ensure there is enough room for installation and maintenance.

Split Type Outdoor Unit

(Refer to Fig 6.4, 6.5, 6.6, 6.10 and Table 6.1)

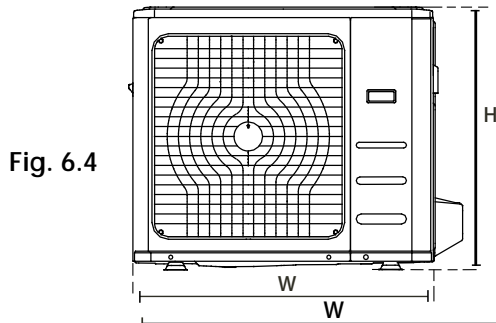

Fig. 6.4

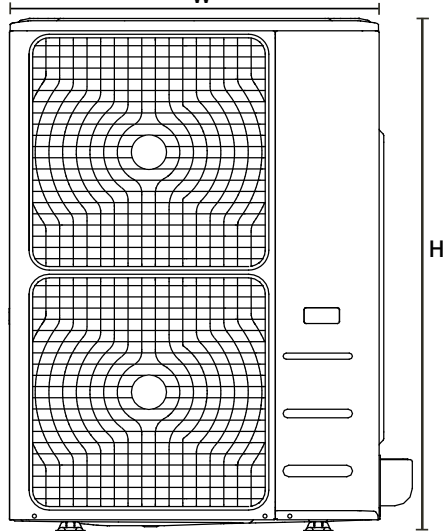

Fig. 6.5

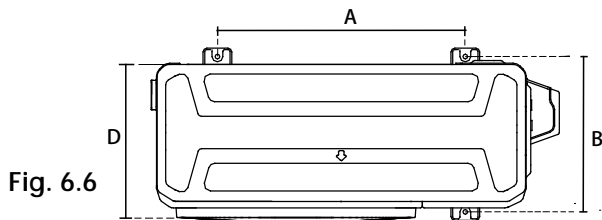

Fig. 6.6

Table 6.1: Length Specifications of Split Type Outdoor Unit (unit: mm/inch)

Outdoor Unit Dimensions W x H x D	Mounting Dimensions	
	Distance A	Distance B
760x590x285 (29.9x23.2x11.2)	530 (20.85)	290 (11.4)
810x558x310 (31.9x22x12.2)	549 (21.6)	325 (12.8)
845x700x320 (33.27x27.5x12.6)	560 (22)	335 (13.2)
900x860x315 (35.4x33.85x12.4)	590 (23.2)	333 (13.1)
945x810x395 (37.2x31.9x15.55)	640 (25.2)	405 (15.95)
990 x965x345 (38.98x38x13.58)	624 (24.58)	366 (14.4)
938x1369x392 (36.93x53.9x15.43)	634 (24.96)	404 (15.9)
900x1170x350 (35.4x46x13.8)	590 (23.2)	378 (14.88)
800x554x333 (31.5x21.8x13.1)	514 (20.24)	340 (13.39)
845x702x363 (33.27x27.6x14.3)	540 (21.26)	350 (13.8)
946x810x420 (37.24x31.9x16.53)	673 (26.5)	403 (15.87)
946x810x410 (37.24x31.9x16.14)	673 (26.5)	403 (15.87)
952x1333x410 (37.5x52.5x16.14)	634 (24.96)	404 (15.9)
952x1333x415 (37.5x52.5x16.34)	634 (24.96)	404 (15.9)

NOTE: The minimum distance between the outdoor unit and walls described in the installation guide does not apply to airtight rooms. Be sure to keep the unit unobstructed in at least two of the three directions (M, N, P) (See Fig. 6.10)

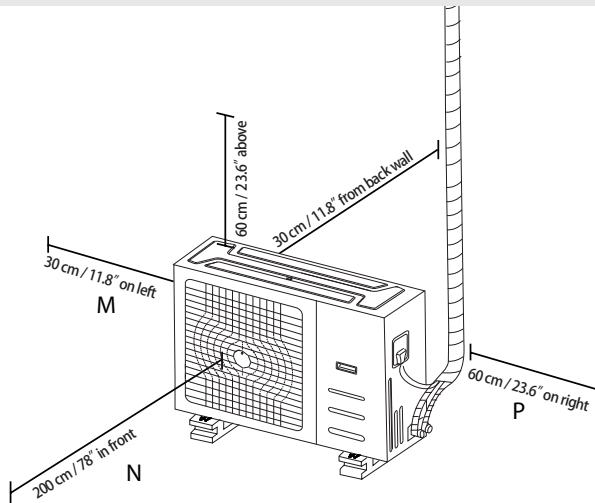

Fig. 6.10

Drain Joint Installation

If the drain joint comes with a rubber seal (see Fig. 6.11 - A), do the following:

1. Fit the rubber seal on the end of the drain joint that will connect to the outdoor unit.
2. Insert the drain joint into the hole in the base pan of the unit.
3. Rotate the drain joint 90° until it clicks in place facing the front of the unit.
4. Connect a drain hose extension (not included) to the drain joint to redirect water from the unit during heating mode.

If the drain joint doesn't come with a rubber seal (see Fig. 6.11 - B), do the following:

1. Insert the drain joint into the hole in the base pan of the unit. The drain joint will click in place.
2. Connect a drain hose extension (not included) to the drain joint to redirect water from the unit during heating mode.

NOTE: Make sure the water drains to a safe location where it will not cause water damage or a slipping hazard.

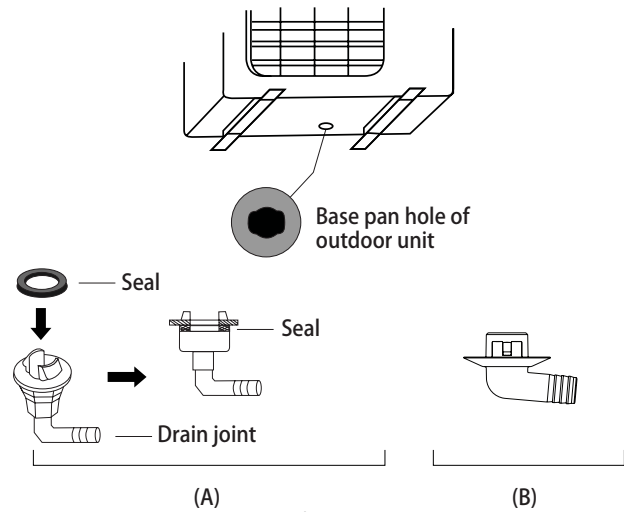

Fig. 6.11

Notes On Drilling Hole In Wall

You must drill a hole in the wall for the refrigerant piping, and the signal cable that will connect the indoor and outdoor units.

1. Determine the location of the wall hole based on the location of the outdoor unit.
2. Using a 65-mm (2.5") core drill, drill a hole in the wall.

NOTE: When drilling the wall hole, make sure to avoid wires, plumbing, and other sensitive components.

3. Place the protective wall cuff in the hole. This protects the edges of the hole and will help seal it when you finish the installation process.

7. CONNECT THE DRAIN PIPE

■ Install the drainpipe of the indoor unit

The outlet has PTI screw bread, Please use sealing materials and pipe sheath(fitting) when connecting PVC pipes.



CAUTION

- The drain pipe of indoor unit must be heat insulated, or it will condense dew, as well as the connections of the indoor unit.
- Hard PVC binder must be used for pipe connection, and make sure there is no leakage.
- With the connection part to the indoor unit, please be noted not to impose pressure on the side of indoor unit pipes.
- When the declivity of the drain pipe downwards is over 1/100, there should not be any winding.
- The total length of the drain pipe when pulled out transversely shall not exceed 20m, when the pipe is over long, a prop stand must be installed to prevent winding.
- Refer to the Fig.7-1 for the installation of the pipes.

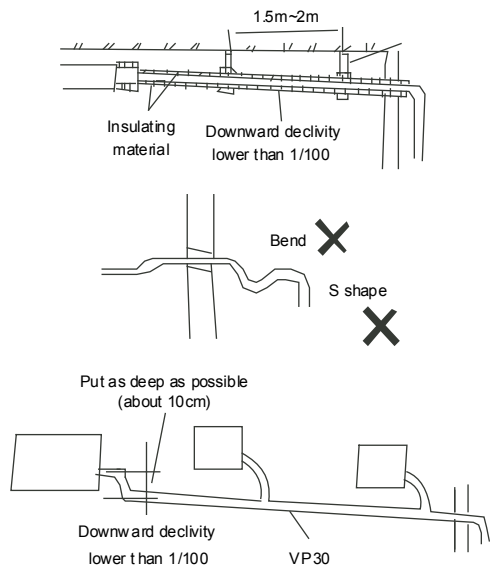

Fig. 7-1

■ Drainage test

- Check whether the drainpipe is un hindered.
- New built house should have this test done before paving the ceiling.

8. INSTALL THE CONNECTING PIPE

Safety Precautions

WARNING

- All field piping must be completed by a licensed technician and must comply with the local and national regulations.
- When the air conditioner is installed in a small room, measures must be taken to prevent the refrigerant concentration in the room from exceeding the safety limit in the event of refrigerant leakage. If the refrigerant leaks and its concentration exceeds its proper limit, hazards due to lack of oxygen may result.
- When installing the refrigeration system, ensure that air, dust, moisture or foreign substances do not enter the refrigerant circuit. Contamination in the system may cause poor operating capacity, high pressure in the refrigeration cycle, explosion or injury.
- Ventilate the area immediately if there is refrigerant leakage during the installation. Leaked refrigerant gas is both toxic and flammable. Ensure there is no refrigerant leakage after completing the installation work.

Notes On Pipe Length and Elevation

Ensure that the length of the refrigerant pipe, the number of bends, and the drop height between the indoor and outdoor units meets the requirements shown in Table 8.1:

Table 8.1: The Maximum Length And Drop Height Based on Models. (Unit: m/ft.)

Type of model	Capacity (Btu/h)	Length of piping	Maximum drop height
R410A Inverter Split Type	<15K	25/82	10/32.8
	≥15K - <24 K	30/98.4	20/65.6
	≥24K - <36 K	50/164	25/82
	≥36K - ≤60K	65/213	30/98.4

! CAUTION

• Oil traps

If the indoor unit is installed higher than the outdoor unit:

-If oil flows back into the outdoor unit's compressor, this might cause liquid compression or deterioration of oil return.

Oil traps in the rising gas piping can prevent this.

An oil trap should be installed every 10m(32.8ft) of vertical suction line riser.(See Fig. 8.1)

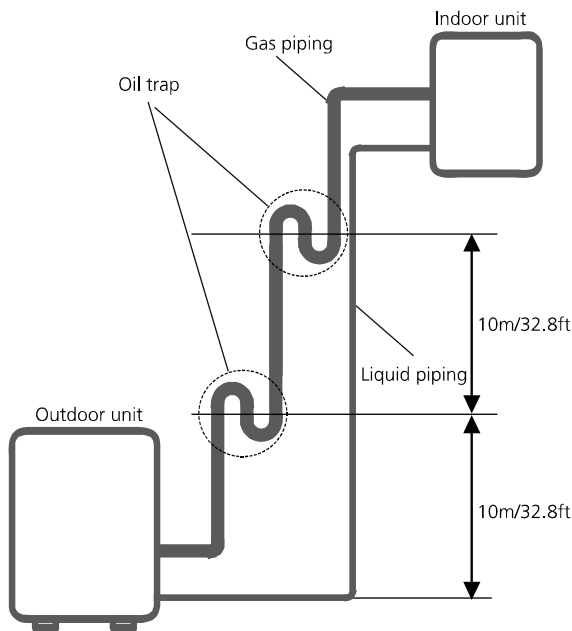

Fig. 8.1

The indoor unit is installed higher than the outdoor unit

! CAUTION

If the outdoor unit is installed higher than the indoor unit:

-It is recommended that vertical suction risers not be upsized. Proper oil return to the compressor should be maintained with suction gas velocity. If velocities drop below 7.62m/s(1500fpm (feet per minute)), oil return will be decreased. An oil trap should be installed every 6m(20ft) of vertical suction line riser. (See Fig. 8.2)

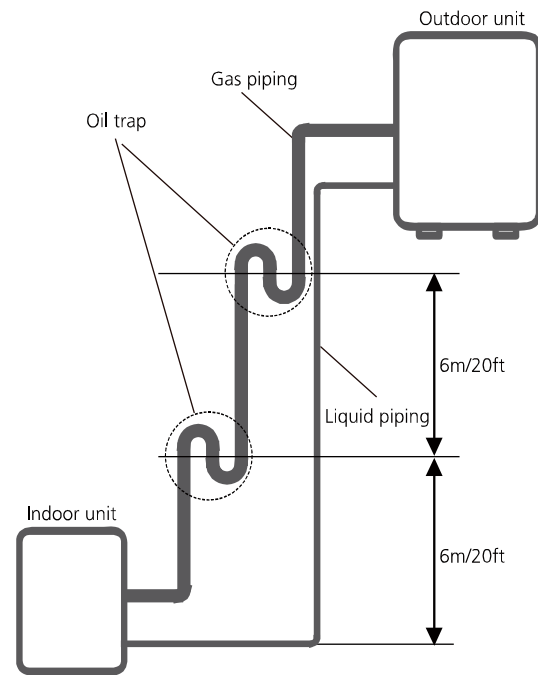

Fig. 8.2

The outdoor unit is installed higher than the indoor unit

Refrigerant Piping Connection Instructions

! CAUTION

- The branching pipe must be installed horizontally. An angle of more than 10° may cause malfunction.
- **DO NOT** install the connecting pipe until both indoor and outdoor units have been installed.
- Insulate both the gas and liquid piping to prevent water leakage.

Step 1: Cut pipes

When preparing refrigerant pipes, take extra care to cut and flare them properly. This will ensure efficient operation and minimize the need for future maintenance.

1. Measure the distance between the indoor and outdoor units.
2. Using a pipe cutter, cut the pipe a little longer than the measured distance.

! CAUTION

DO NOT deform pipe while cutting. Be extra careful not to damage, dent, or deform the pipe while cutting. This will drastically reduce the heating efficiency of the unit.

1. Make sure that the pipe is cut at a perfect 90° angle. Refer to Fig. 8.3 for examples of bad cuts

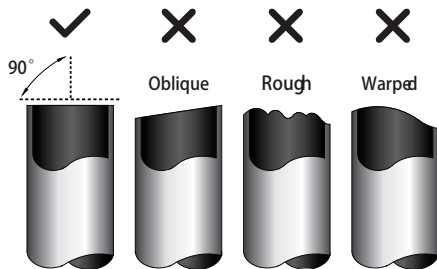

Fig. 8.3

Step 2: Remove burrs.

Burrs can affect the air-tight seal of refrigerant piping connections. They must be completely removed.

1. Hold the pipe at a downward angle to prevent burrs from falling into the pipe.
2. Using a reamer or deburring tool, remove all burrs from the cut section of the pipe.

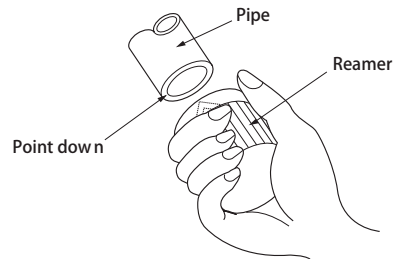

Fig. 8.4

Step 3: Flare pipe ends

Proper flaring is essential to achieve an airtight seal.

1. After removing burrs from cut pipe, seal the ends with PVC tape to prevent foreign materials from entering the pipe.
- 2.
3. Place flare nuts on both ends of pipe. Make sure they are facing in the right direction, because you can't put them on or change their direction after flaring. See Fig. 8.5

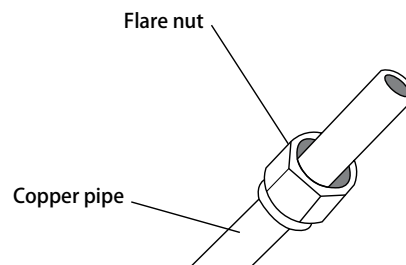

Fig. 8.5

4. Remove PVC tape from ends of pipe when ready to perform flaring work.
5. Clamp flare form on the end of the pipe. The end of the pipe must extend beyond the flare form.

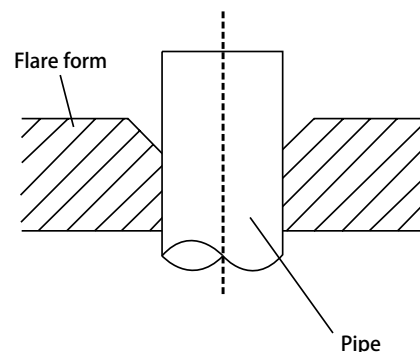

Fig. 8.6

6. Place flaring tool onto the form.
7. Turn the handle of the flaring tool clockwise until the pipe is fully flared. Flare the pipe in accordance with the dimensions shown in table 8.2.

Table 8.2: PIPING EXTENSION BEYOND FLARE FORM

Pipe gauge	Tightening torque (Unit: mm/Inch)	Flare dimension (A) (Unit: mm/Inch)		Flare shape
		Min.	Max.	
Ø 6.4	18-20 N.m (183-204 kgf.cm)	8.4/0.33	8.7/0.34	<p>Fig. 8.7</p>
Ø 9.5	25-26 N.m (255-265 kgf.cm)	13.2/0.52	13.5/0.53	
Ø 12.7	35-36 N.m (357-367 kgf.cm)	16.2/0.64	16.5/0.65	
Ø 15.9	45-47 N.m (459-480 kgf.cm)	19.2/0.76	19.7/0.78	
Ø 19.1	65-67 N.m (663-683 kgf.cm)	23.2/0.91	23.7/0.93	
Ø 22	75-85 N.m (765-867 kgf.cm)	26.4/1.04	26.9/1.06	

8. Remove the flaring tool and flare form, then inspect the end of the pipe for cracks and even flaring.

Step 4: Connect pipes

Connect the copper pipes to the indoor unit first, then connect it to the outdoor unit. You should first connect the low-pressure pipe, then the high-pressure pipe.

1. When connecting the flare nuts, apply a thin coat of refrigeration oil to the flared ends of the pipes.
2. Align the center of the two pipes that you will connect.

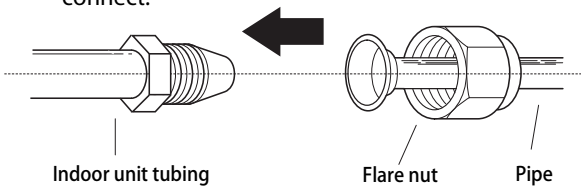
Fig. 8.8

3. Tighten the flare nut as tightly as possible by hand.
4. Using a spanner, grip the nut on the unit tubing.
5. While firmly gripping the nut, use a torque wrench to tighten the flare nut according to the torque values in table 8.2.

NOTE: Use both a spanner and a torque wrench when connecting or disconnecting pipes to/from the unit.

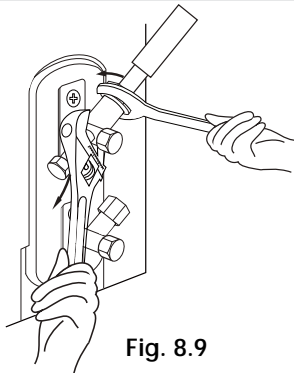
Fig. 8.9

! CAUTION

- Be sure to wrap insulation around the piping. Direct contact with the bare piping may result in burns or frostbite.
- Make sure the pipe is properly connected. Over tightening may damage the bell mouth and under tightening may lead to leakage.

NOTE ON MINIMUM BEND RADIUS

Carefully bend the tubing in the middle according to the diagram below. **DO NOT** bend the tubing more than 90° or more than 3 times.

Bend the pipe with thumb

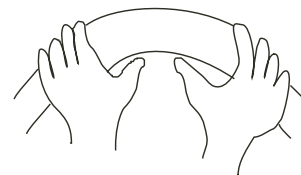

min-radius 10cm (3.9')

Fig. 8.10

6. After connecting the copper pipes to the indoor unit, wrap the power cable, signal cable and the piping together with binding tape.

NOTE: DO NOT intertwine signal cable with other wires. While bundling these items together, do not intertwine or cross the signal cable with any other wiring.

7. Thread this pipeline through the wall and connect it to the outdoor unit.
8. Insulate all the piping, including the valves of the outdoor unit.
9. Open the stop valves of the outdoor unit to start the flow of the refrigerant between the indoor and outdoor unit.

! CAUTION

Check to make sure there is no refrigerant leak after completing the installation work. If there is a refrigerant leak, ventilate the area immediately and evacuate the system (refer to the Air Evacuation section of this manual).

9. AIR EVACUATION

Safety Precautions

! CAUTION

- Use a vacuum pump with a gauge reading lower than -0.1MPa and an air discharge capacity above 40L/min.
- The outdoor unit does not need vacuuming. **DO NOT** open the outdoor unit 's gas and liquid stop valves.
- Ensure that the Compound Meter reads -0.1MPa or below after 2 hours. If after three hours of operation and the gauge reading is still above -0.1MPa, check if there is a gas leak or water inside the pipe. If there is no leakage, perform another evacuation for 1 or 2 hours.
- **DO NOT** use refrigerant gas to evacuate the system.

Evacuation Instructions

Before using manifold gauge and vacuum pump, read their operation manuals to familiarize yourself with how to use them properly.

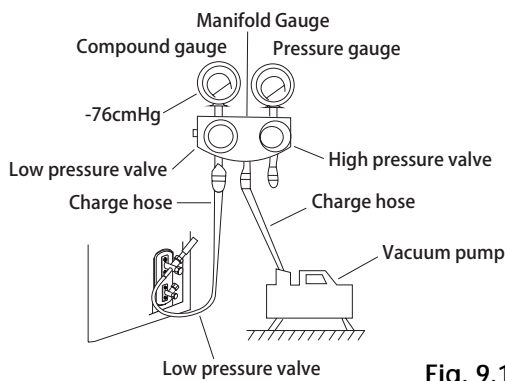

Fig. 9.1

1. Connect the charge hose of the manifold gauge to service port on the outdoor unit's low pressure valve.
2. Connect another charge hose from the manifold gauge to the vacuum pump.
3. Open the Low Pressure side of the manifold gauge. Keep the High Pressure side closed.
4. Turn on the vacuum pump to evacuate the system.
5. Run the vacuum for at least 15 minutes, or until the Compound Meter reads -76cmHG (-1x105Pa).
6. Close the Low Pressure side of the manifold gauge, and turn off the vacuum pump.
7. Wait for 5 minutes, then check that there has been no change in system pressure.

NOTE: If there is no change in system pressure, unscrew the cap from the packed valve (high pressure valve). If there is a change in system pressure, there may be a gas leak.

8. Insert hexagonal wrench into the packed valve (high pressure valve) and open the valve by turning the wrench in a 1/4 counterclockwise turn. Listen for gas to exit the system, then close the valve after 5 seconds.

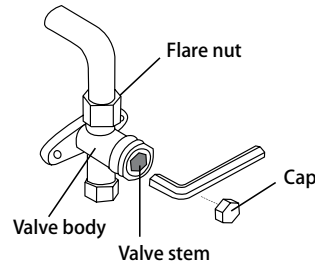

Fig. 9.2

9. Watch the Pressure Gauge for one minute to make sure there is no change in pressure. The Pressure Gauge should read slightly higher than atmospheric pressure.
10. Remove the charge hose from the service port.
11. Using hexagonal wrench, fully open both the high pressure and low pressure valves.

OPEN VALVE STEMS GENTLY

When opening valve stems, turn the hexagonal wrench until it hits against the stopper. **DO NOT** try to force the valve to open further.

12. Tighten valve caps by hand, then tighten it using the proper tool.

Note On Adding Refrigerant

! CAUTION

- Refrigerant charging must be performed after wiring, vacuuming and the leak test.
 - **DO NOT** exceed the maximum allowable quantity of refrigerant or overcharge the system. Doing so can damage or impact the unit 's function.
 - Charging with unsuitable substances may cause explosions or accidents. Ensure that the appropriate refrigerant is used.
 - Refrigerant containers must be opened slowly. Always use protective gear when charging the system.
 - **DO NOT** mix refrigerants types.
- The outdoor unit is factory charged with refrigerant. Calculate the added refrigerant according to the diameter and the length of the liquid side pipe of the outdoor unit/indoor unit connection.(suitable for throttle outdoor unit)

Table 9-1

Liquid tube(mm)		R410A
1/4"	orifice in the outdoor unit	0.011kg/m×(L-5)
3/8"	orifice in the outdoor unit	0.030kg/m×(L-5)

NOTE: The table above refers to the liquid tube.

The number of bends is up to the length of the max height drop. Usually for each 32 ft need a bend. If a negative result is gotten for R from Table 9-1, no refrigerant needs to be added nor removed.

10. WIRING

The appliance shall be installed in accordance with national wiring regulations.

The air conditioner should use separate power supply with rated voltage.

The external power supply to the air conditioner should have ground wiring, which is linked to the ground wiring of the indoor and outdoor unit.

The wiring work should be done by qualified persons according to circuit drawing.

An all-pole disconnection device which has at least 3mm separation distance in all pole and a residual current device (RCD) with the rating of above 10mA shall be incorporated in the wiring according to the national rule.

Be sure to locate the power wiring and the signal wiring well to avoid cross-wiring.

Do not turn on the power until you have checked carefully after wiring.

NOTE: Remark per EMC Directive 2004/108/EC.

To prevent flicker impressions during the start of the compressor (technical process), following installation conditions do apply.

1. The power connection for the air conditioner has to be done at the main power distribution. The distribution has to be of a low impedance, normally the required impedance reaches at a 32 A fusing point.
2. No other equipment can be connected with this power line.
3. For detailed installation acceptance please refer to your power supplier, if restrictions do apply for products like washing machines, air conditioners or electrical ovens.
4. For power details of the air conditioner refer to the rating plate of the product.
5. For any question contact your local dealer.

10.1 Connect the cable

- Remove the electric cover of the outdoor unit. If there is no cover on the outdoor unit, disassemble the bolts from the maintenance board and remove the protection board. (See Fig. 10.1)

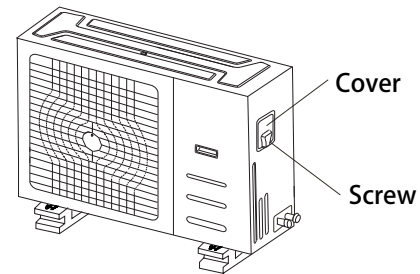

Fig. 10.1

- Connect the cables to the terminals as identified with their respective matched numbers on the terminal block of indoor and outdoor units.
- Re-install the cover or the protection board.

10.2 The Specification of Power

(Refer to Table10-1)

10.3 Wiring figure

(Refer to Fig.10-2 and Fig.10-3)

11. TEST OPERATION

- 1 The test operation must be carried out after the entire installation has been completed.
- 2 Please confirm the following points before the test operation:
 - The indoor unit and outdoor unit are installed properly.
 - Tubing and wiring are correctly completed.
 - The refrigerant pipe system is leakage-checked.
 - The drainage is unimpeded.
 - The heating insulation works well.
 - The ground wiring is connected correctly.
 - The length of the tubing and the added stow capacity of the refrigerant have been recorded.
 - The power voltage fits the rated voltage of the air conditioner.
 - There is no obstacle at the outlet and inlet of the outdoor and indoor units.
 - The gas-side and liquid-side stop valves are both opened.
 - The air conditioner is pre-heated by turning on the power.
- 3 According to the user's requirement, install the remote controller frame where the remote controller's signal can reach the indoor unit smoothly.
- 4 Test operation
 - Set the air conditioner under the mode of "COOLING" with the remote controller, and check the following points. If there is any malfunction, please resolve it according to the chapter "Troubleshooting" in the "Owner's Manual".
 - 1) The indoor unit
 - a. Whether the switch on the remote controller works well.
 - b. Whether the buttons on the remote controller work well.
 - c. Whether the air flow louver moves normally.
 - d. Whether the room temperature is adjusted well.
 - e. Whether the indicator lights normally.
 - f. Whether the temporary buttons work well.
 - g. Whether the drainage is normal.
 - h. Whether there is vibration or abnormal noise during operation.
 - i. Whether the air conditioner heats well.
 - 2) The outdoor unit
 - a. Whether there is vibration or abnormal noise during operation.
 - b. Whether the generated wind, noise, or condensed water of the air conditioner have influenced your neighborhood.
 - c. Whether any of the refrigerant has leaked.



CAUTION

A protection feature prevents the air conditioner from being activated for approximately 3 minutes when it is restarted immediately after shut off.

The Specification of Power for the invert type air conditioner (independant power supply)

■ Table 10-1

MODEL		18	24	30~36
POWER (indoor)	PHASE	1Phase	1Phase	1Phase
	VOLT	220-240V	220-240V	220-240V
CIRCUIT BREAKER/FUSE(A)		15/10	15/10	15/10
POWER (outdoor)	PHASE	1Phase	1Phase	1Phase
	VOLT	208-240V	208-240V	208-240V
CIRCUIT BREAKER/FUSE(A)		30/20	30/20	40/30



CAUTION

The power supply is included in the power supply above mentioned can be applied to the table. Before obtaining access to terminals, all supply circuits must be disconnected.

■ **Wiring figure**

■ **Fig.10-2**

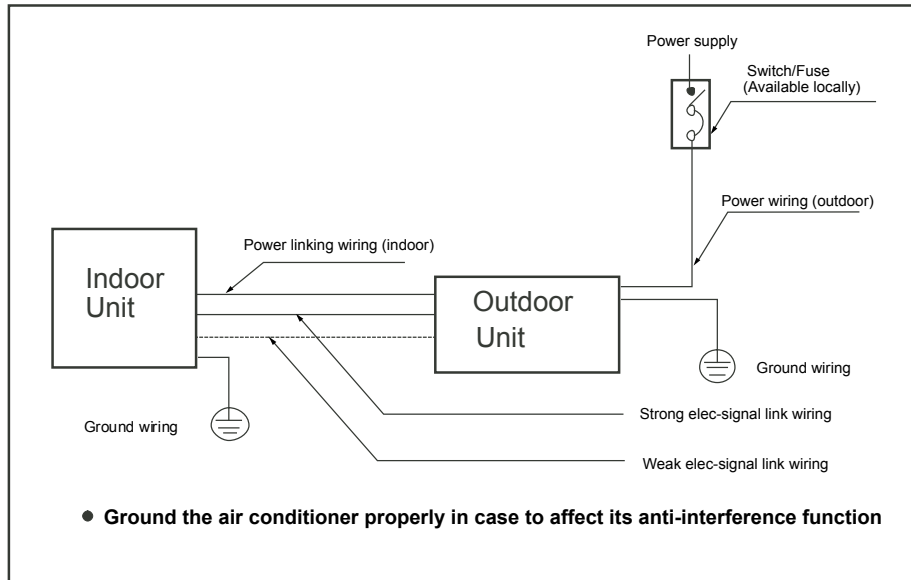

■ **Fig.10-3**

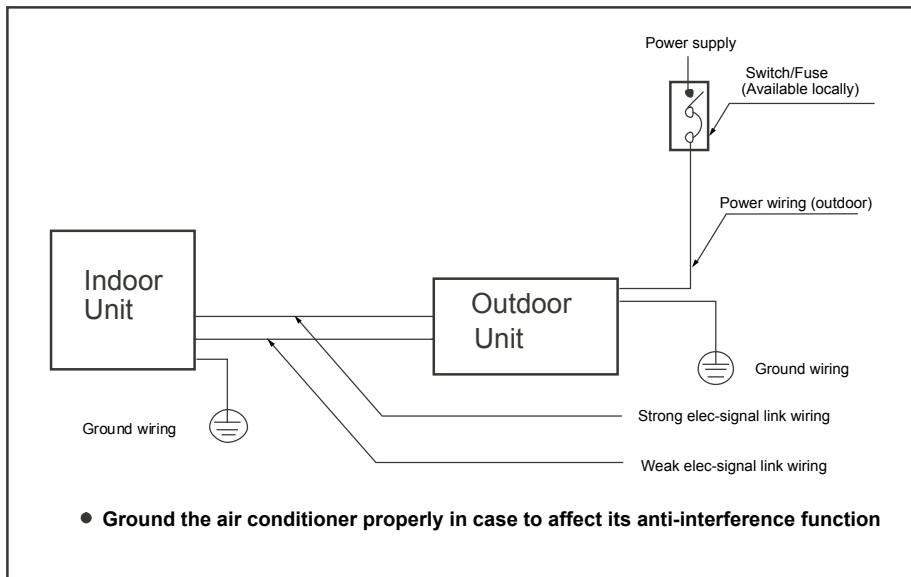

CAUTION

A disconnection device having an air gap contact separation in all active conductors should be incorporated in the fixed wiring according to the National Wiring Regulation.

When wiring, please choose the corresponding chart, or it may cause damage. The signs of the indoor terminal block in the some of following figures may be replaced by L N L1 N1.

Due to ongoing product improvements, specifications and dimensions are subject to change and correction without notice or incurring obligations. Determining the application and suitability for use of any product is the responsibility of the installer. Additionally, the installer is responsible for verifying dimensional data on the actual product prior to beginning any installation preparations.

Incentive and rebate programs have precise requirements as to product performance and certification. All products meet applicable regulations in effect on date of manufacture; however, certifications are not necessarily granted for the life of a product. Therefore, it is the responsibility of the applicant to determine whether a specific model qualifies for these incentive/rebate programs.

Comfort-Cire®  **Century**

1900 Wellworth Ave., Jackson, MI 49203 • Ph. 517-787-2100 • www.marsdelivers.com

