

Cast Iron

DC-CI

CHARLOTTE
PIPE AND FOUNDRY COMPANY

DIMENSIONAL CATALOG

No-Hub Pipe and Fittings

Service Pipe and Fittings

Extra Heavy Pipe and Fittings

Plugs

[Updated February 14, 2020]

You can't beat the system.®

© 1977-2020 Charlotte Pipe and Foundry Company

Cast Iron Pipe and Fitting Dimensions

Table of Contents

	<u>Page</u>
No-Hub Pipe Dimensions	3&5
No-Hub Fitting Dimensions.....	4-43
No-Hub Starter Fitting Detail Drawings	44-50
Service Pipe Dimensions	51-53
Service Fitting Dimensions	54-102
Extra Heavy Pipe Dimensions	103-105
Extra Heavy Fitting Dimensions.....	106-119
Plug Dimensions.....	120
Certification	121
Warranty	123



Download our Tech Tools App for dimensional info, tech calculators and more on your mobile device.



This catalog accurately reflects dimensional information to the best of our knowledge. If dimensions on your job are critical, please verify dimensional information with our factory.

This dimensional catalog accurately reflects our product line at the time the catalog was printed. However, we add and delete items on an ongoing basis to better serve our customers. Please refer to our current list price sheets for an accurate listing of items offered.

Charlotte Pipe® products are manufactured to the applicable ASTM standard. Charlotte Pipe and Foundry cannot accept responsibility for the performance, dimensional accuracy, or compatibility of pipe, fittings, gaskets, or couplings not manufactured or sold by Charlotte Pipe and Foundry.

Charlotte Pipe and "You can't beat the system" are registered trademarks of Charlotte Pipe and Foundry Company.

No-Hub

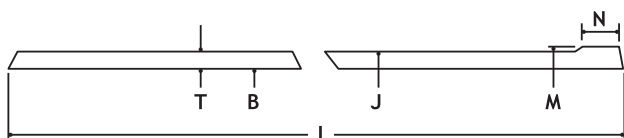

TABLE 1
DIMENSIONS AND TOLERANCES (IN INCHES) OF SPIGOTS
AND BARRELS FOR NO-HUB PIPE AND FITTINGS

Size	Inside Barrel Diameter	Outside Diameter Barrel	Outside Diameter Spigot	Width Spigot Bead N	Thickness of Barrel		Gasket Positioning Lug
	B	J	M	(± .13)	T-Nom.	T-Min.	W
1 1/2	1.50 ± .09	1.90 ± .06	1.96 ± .06	.25	.16	.13	1.13
2	1.96 ± .09	2.35 ± .09	2.41 ± .09	.25	.16	.13	1.13
3	2.96 ± .09	3.35 ± .09	3.41 ± .09	.25	.16	.13	1.13
4	3.94 ± .09	4.38 ± .09	4.44 ± .09	.31	.19	.15	1.13
5	4.94 ± .09	5.30 ± .09	5.36 ± .09	.31	.19	.15	1.50
6	5.94 ± .09	6.30 ± .09	6.36 ± .09	.31	.19	.15	1.50
8	7.94 ± .13	8.38 ± .09	8.44 ± .09	.31	.23	.17	2.00
10	10.00 ± .13	10.56 ± .09	10.62 ± .09	.31	.28	.22	2.00
12	11.94 ± .09	12.50 ± .13	12.62 ± .13	.31	.28	.22	2.75
15	15.11 ± .09	15.83 ± .13	16.12 ± .13	.31	.36	.30	2.75

TEN FOOT PIPE BUNDLES NO-HUB PIPE

Size	Pieces	Weight	Height
1 1/2" x 10'	72	2052	12"
2" x 10'	54	1906	11"
3" x 10'	36	1944	14"
4" x 10'	27	2052	17"
5" x 10'	24	2342	20"
6" x 10'	18	2120	23"
8" x 10'	8	1367	22"
10" x 10'	6	1528	26"
12" x 10'	6	1908	29"
15" x 10'	2	985	19"

Weights are approximate and are for shipping purposes only.

PART NO. NH 1

No-Hub (Standard) Coupling

Size	Shield Width	Number of Clamps
1½	2.13"	2
2 x 1½	2.13"	2
2	2.13"	2
3 x 2	2.13"	2
3	2.13"	2
4 x 3	2.13"	2
4	2.13"	2
5	3.00"	4
6	3.00"	4
8	4.00"	4
10	4.00"	4



PART NO. MDC 2

Heavy Duty (MD) Coupling

Size	Shield Width	Number of Clamps
1½	3.00"	4
2	3.00"	4
3	3.00"	4
4	3.00"	4
5	4.00"	6
6	4.00"	6
8	4.00"	6
10	4.00"	6



PART NO. SDC 4

Heavy Duty (HD) Coupling

Size	Shield Width	Number of Clamps
1½	3.00"	4
2	3.00"	4
3	3.00"	4
4	3.00"	4
5	4.00"	6
6	4.00"	6
8	4.00"	6
10	4.00"	6



PART NO. HD 1

Heavy Duty Coupling



Size	Shield Width	Number of Clamps
12	5.50"	6
15	5.50"	6

PART NO. NH 2



No-Hub Pipe - Ten Feet Laying Length

Size	Weight
1½" x 10'	28.5
2" x 10'	35.0
3" x 10'	54.0
4" x 10'	76.0
5" x 10'	97.6
6" x 10'	117.8
8" x 10'	170.9
10" x 10'	254.6
12" x 10'	318.1
15" x 10'	492.6

PART NO. NH 4

Quarter Bend

Size	D	Weight
1½	4¼	1.7
2	4½	2.2
3	5	3.7
4	5½	6.5
5	6½	9.3
6	7	15.0
8	8½	23.1
4 x 3	5½	5.5

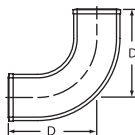

Long Quarter Bend

Size	D	E	Weight
2 x 12	12	4½	5.4
2 x 18	18	4½	8.8
2 x 24	24	4½	10.7
3 x 12	12	5	8.5
4 x 12	12	5½	11.2

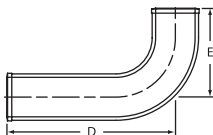

N O - H U B

PART NO. NH 4A

Tapped Quarter Bend

Size	D	E	Weight
1½ x 1½	3	2	1.9
2 x 1¼	3¼	2¼	2.0
2 x 1½	3¼	2¼	1.8
2 x 2	3¼	2¼	2.9



PART NO. NH 6

Quarter Bend with Side Opening

Size	E	D	Weight
3 x 2	3¼	4	5.1
4 x 2	3¾	4 ⁵ / ₁₆	7.5

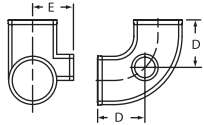

PART NO. NH 8

Quarter Bend with Heel Opening

Size	D	E	Weight
3 x 2	5	2 ⁷ / ₈	5.6
4 x 2	5½	3¼	7.2

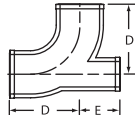

PART NO. NH 8A

Double Quarter Bend

Size	D	Weight
2	4½	4.5
3	5	7.1
4	5½	9.7

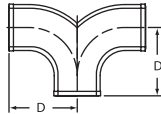

PART NO. NH 8B

**Extended Quarter Bend
with Low Heel Outlet**

Size	D	E	Weight
3 x 2	5	10 1/2	7.8

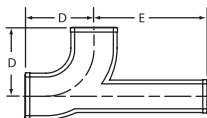

PART NO. NH 9

Fifth Bend

Size	D	Weight
2	3 11/16	2.3
3	4 1/16	3.7
4	4 7/16	6.1

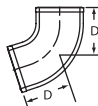

PART NO. NH 10

Sixth Bend

Size	D	Weight
2	3 1/4	2.2
3	3 1/2	3.0
4	3 13/16	5.3

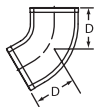

PART NO. NH 12

Eighth Bend

Size	D	Weight
1 1/2	2 5/8	1.5
2	2 3/4	1.5
3	3	2.9
4	3 1/8	4.0
5	3 7/8	7.4
6	4 1/16	9.1
8	5	14.9
10	5 15/16	31.7
12	6 9/16	31.6
15	7 13/16	62.0



PART NO. NH 12

Long Eighth Bend

Size	D	E	Weight
2 x 12	12	2 ³ / ₄	4.6
2 x 18	18	2 ³ / ₄	7.3
3 x 12	12	3	8.0
3 x 18	18	3	10.2
4 x 12	12	3 ¹ / ₈	9.7

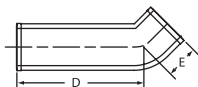

PART NO. NH 14

Sixteenth Bend

Size	D	Weight
1 ¹ / ₂	2 ¹ / ₈	1.2
2	2 ¹ / ₈	1.4
3	2 ¹ / ₄	2.1
4	2 ⁵ / ₁₆	3.4
5	2 ⁷ / ₈	5.4
6	3	6.7
8	3 ³ / ₄	12.0



PART NO. NH 16

Short Sweep

Size	D	Weight
2	6 ¹ / ₂	3.1
3	7	6.3
4	7 ¹ / ₂	8.1
5	8 ¹ / ₂	13.1
6	9	17.1
8	10 ¹ / ₂	31.0
10	12	53.4
12	13 ¹ / ₄	61.3
15	14 ³ / ₄	105.6

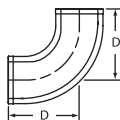

PART NO. EZS 14

Extended Short Sweep

Size	E	F	Weight
2 x 18	6½	18	8.0
2 x 24	6½	24	11.0
2 x 34	6½	34	13.9

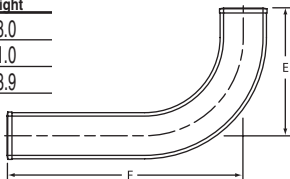

N O H U B

PART NO. NH 18

Long Sweep

Size	D	Weight
1½	9¼	4.4
2	9½	5.8
3	10	9.4
4	10½	12.3
5	11½	18.6
6	12	23.3

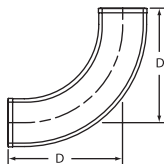

PART NO. NH 18

Reducing Long Sweep

Size	D	Weight
4 x 3	10½	12.4

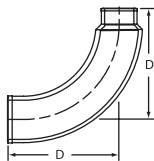

PART NO. NH 20

Size	Wye			Weight
	D	F	G	
1½ x 1½	4	6	2	2.5
2 x 2	4 ⁵ / ₈	6 ⁵ / ₈	2	3.3
3 x 1½	4 ⁵ / ₈	6 ¹ / ₈	1 ¹⁵ / ₁₆	4.4
3 x 2	5 ⁵ / ₁₆	6 ⁵ / ₈	1½	3.4
3	5¾	8	2¼	4.6
4 x 2	6	6 ⁵ / ₈	1	5.1
4 x 3	6½	8	1 ¹¹ / ₁₆	7.3
4	7 ¹ / ₁₆	9½	2 ⁷ / ₁₆	9.1
5 x 2	7½	8 ¹ / ₁₆	1 ¹⁵ / ₁₆	8.8
5 x 3	8	9 ¹¹ / ₁₆	1 ¹¹ / ₁₆	10.5
5 x 4	8½	11 ³ / ₁₆	2 ⁷ / ₁₆	13.1
5	9½	12 ⁵ / ₈	3 ¹ / ₈	15.1
6 x 2	8¼	8 ⁵ / ₁₆	½	9.8
6 x 3	8¾	9¾	1¼	12.5
6 x 4	9¼	11 ³ / ₁₆	1 ¹⁵ / ₁₆	14.6
6 x 5	10¼	12½	2 ⁹ / ₁₆	17.6
6	10¾	14 ¹ / ₁₆	3 ⁵ / ₁₆	19.7
8 x 3	9 ¹³ / ₁₆	9 ¹⁵ / ₁₆	⅛	17.5
8 x 4	10 ³ / ₈	11 ⁷ / ₁₆	1 ¹⁵ / ₁₆	22.0
8 x 5	11 ³ / ₈	12 ¹³ / ₁₆	1 ⁵ / ₈	23.9
8 x 6	11 ¹³ / ₁₆	14 ³ / ₁₆	2 ⁵ / ₁₆	28.3
8	13 ³ / ₈	17 ¹ / ₈	3¾	36.3
10 x 4	11 ¹¹ / ₁₆	12 ⁵ / ₈	¾	32.9
10 x 6	13 ¹ / ₈	15 ⁷ / ₁₆	2 ³ / ₁₆	42.1
10 x 8	14 ¹¹ / ₁₆	18 ³ / ₈	3 ⁵ / ₈	56.1
10	16½	21½	5 ¹ / ₁₆	74.9
12	19¾	25½	5¾	97.0
15	23¼	30	6¾	189.5

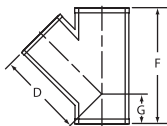

PART NO. NH 21

Double Wye

Size	D	F	Weight
2	4 ⁵ / ₈	6 ⁵ / ₈	4.5
3 x 2	5 ⁵ / ₁₆	6 ⁵ / ₈	5.5
3	5 ³ / ₄	8	7.9
4 x 2	6	6 ⁵ / ₈	6.5
4 x 3	6 ¹ / ₂	8	8.8
4	7 ¹ / ₁₆	9 ¹ / ₂	12.1
5 x 4	8 ¹ / ₂	11 ³ / ₁₆	15.7
6 x 4	9 ¹ / ₄	11 ³ / ₁₆	16.4
6	10 ³ / ₄	14 ¹ / ₁₆	27.4
8	13 ³ / ₈	17 ¹ / ₈	45.3
8 x 4	10 ³ / ₈	11 ⁷ / ₁₆	23.0
8 x 6	11 ¹³ / ₁₆	14 ³ / ₁₆	31.3

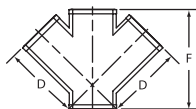

N
O
-
H
U
B

PART NO. NH 21A

Upright Wye

Size	H	E	F	G	Weight
2	8 ¹ / ₄	5 ¹ / ₂	7	2	4.8
3 x 2	8 ³ / ₁₆	5 ¹ / ₂	7	1 ¹ / ₂	5.7
3	8 ⁷ / ₁₆	5 ¹ / ₂	8 ³ / ₈	2 ³ / ₁₆	9.5
4 x 2	8 ¹ / ₄	5 ¹ / ₂	7	1	7.7
4 x 3	8 ⁷ / ₁₆	5 ¹ / ₂	8 ³ / ₈	1 ¹¹ / ₁₆	10.1
4	9 ¹ / ₈	6	9 ³ / ₄	2 ⁷ / ₁₆	12.9
5 x 2	9	6 ¹ / ₈	8	1	11.0
5	11 ⁷ / ₁₆	7 ¹ / ₈	12 ³ / ₄	2 ³ / ₄	19.9

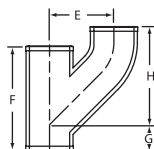

PART NO. NH 22

Combination

Size	D	E	F	Weight
1½	4¾	5¾	6	3.1
2 x 1½	5	5¾	6	3.4
2	5¾	6¼	6⅝	3.5
3 x 1½	5½	6¾	6⅝	5.0
3 x 2	5½	6¾	6⅝	5.7
3	7 ⁵ / ₁₆	8	8	8.5
4 x 2	5½	7¼	6⅝	6.6
4 x 3	7¼	8½	8	9.5
4	9¼	10	9½	13.7
5 x 2	5 ¹⁵ / ₁₆	7¾	8 ¹ / ₁₆	8.5
5 x 3	7¾	9	9 ¹¹ / ₁₆	12.0
5 x 4	9¾	10½	11 ³ / ₁₆	17.1
5	11¾	12½	12 ⁵ / ₈	19.7
6 x 2	6	8¼	8 ⁵ / ₁₆	12.0
6 x 3	7 ¹³ / ₁₆	9½	9¾	14.7
6 x 4	9¾	11	11 ³ / ₁₆	18.4
6 x 5	11 ¹¹ / ₁₆	13	12½	23.4
6	13 ⁵ / ₈	14¾	14 ¹ / ₁₆	30.0
8 x 4	9 ⁷ / ₁₆	11 ⁵ / ₁₆	11 ³ / ₁₆	25.1
8 x 6	12	13¾	13 ¹⁵ / ₁₆	35.4
8	14¾	15 ⁹ / ₁₆	16 ¹⁵ / ₁₆	49.3

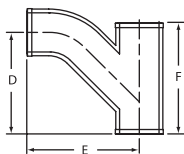

PART NO. EZS 15

Extended Combination

Size	E	F	G	Weight
2 x 24	6 ³ / ₁₆	25 ³ / ₈	24	12.0
2 x 36	6 ³ / ₁₆	36	34¾	15.4

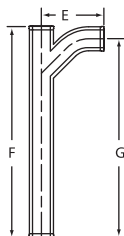

PART NO. NH 24

Double Combination

Size	D	E	F	Weight
2	5 ³ / ₈	6 ¹ / ₈	6 ⁵ / ₈	6.3
3 x 2	5 ¹ / ₂	6 ³ / ₄	6 ⁵ / ₈	7.7
3	7 ⁵ / ₁₆	8	8	11.8
4 x 2	5 ¹ / ₂	7 ¹ / ₄	6 ⁵ / ₈	8.3
4 x 3	7 ¹ / ₄	8 ¹ / ₂	8	13.7
4	9 ¹ / ₄	10	9 ¹ / ₂	20.5

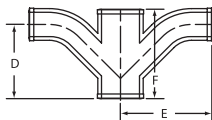

N
O
-
H
U
B

PART NO. NH 26

Tapped Wye

Size	D	F	Weight
2 x 1 ¹ / ₂	5 ¹ / ₁₆	6 ⁵ / ₈	3.4
2 x 2	5 ¹ / ₁₆	6 ⁵ / ₈	4.6
3 x 1 ¹ / ₂	5 ³ / ₄	6 ⁵ / ₈	5.1
3 x 2	5 ¹³ / ₁₆	6 ⁵ / ₈	5.3
4 x 1 ¹ / ₂	6 ⁷ / ₁₆	6 ⁵ / ₈	6.0
4 x 2	6 ¹ / ₂	6 ⁵ / ₈	7.2

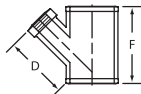

PART NO. NH 27

Tapped Double Wye

Size	D	F	Weight
2 x 1 ¹ / ₂	5 ¹ / ₁₆	6 ⁵ / ₈	5.6

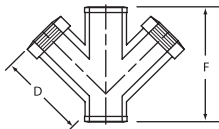

PART NO. NH 28

Sanitary Tee

Size	E	F	D	Weight
1½ x 1½	4¼	6½	4¼	2.9
2 x 1½	4½	6 ⁵ / ₈	4¼	3.4
2	4½	6 ⁷ / ₈	4½	3.1
3 x 1½	5	6½	4¼	4.5
3 x 2	5	6 ⁷ / ₈	4½	3.7
3	5	8	5	5.5
4 x 2	5½	6 ⁷ / ₈	4½	5.3
4 x 3	5½	8	5	7.6
4	5½	9 ¹ / ₈	5½	8.5
5 x 2	6½	8½	5	8.3
5 x 3	6	9 ⁵ / ₁₆	5½	10.2
5 x 4	6	10 ¹³ / ₃₂	6	11.5
5	6½	11 ⁷ / ₁₆	6½	12.5
6 x 2	6½	8 ³ / ₁₆	5	9.9
6 x 3	6½	9 ³ / ₁₆	5½	11.5
6 x 4	6½	10 ¹ / ₁₆	6	12.0
6 x 5	7	11½	6½	15.6
6	7	12½	7	12.9
8 x 3	7½	10 ³ / ₈	6	17.9
8 x 4	7½	11½	6½	21.6
8 x 5	8	12½	7	24.0
8 x 6	8	13½	7½	24.0
8	8½	15½	8½	30.8

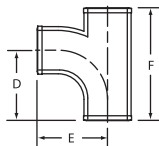

PART NO. EZS 16

2" Two-Way Sanitary Tee

Size	E	H	F	Weight
2 x 18	4½	4½	18	7.8
2 x 24	4½	4½	24	10.4
2 x 36	4½	4½	36	15.6

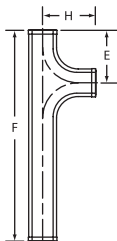

PART NO. NH 30

Sanitary Cross

Size	E	F	D	Weight
1½	4¼	6½	4½	3.6
2	4½	6⅞	4½	5.0
3x2	5	6⅞	4½	6.2
3	5	8	5	7.6
4x2	5½	6⅞	4½	7.3
4x3	5½	8	5	8.5
4	5½	9⅞	5½	11.0
5x4	6	10 ¹³ / ₃₂	6	13.4
6x4	6½	10 ¹ / ₁₆	6	14.0
6	7	12½	7	21.0
8x4	7½	11½	6½	23.0
8	8½	15½	8½	37.9



N O - H U B

PART NO. NH 31

**Sanitary Tee with 2" 90° Sanitary
Opening Above Center
(New Orleans Code)**

Size	C	D	E	F	G	Weight
3 (L)	4½	6	5	8½	5	6.7
3 (R)	4½	6	5	8½	5	6.3
4 (L)	5	6½	5½	9 ³ / ₁₆	5½	8.6
4 (R)	5	6½	5½	9 ³ / ₁₆	5½	8.5

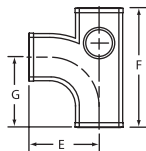
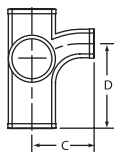

(Right Inlet)

PART NO. NH 32

**Sanitary Tee with 2" Side Inlets
Right Hand and Left Hand**

Size	E	F	D	Weight
4 x 4 w/RH & LH	5 ⁹ / ₁₆	9⅞	5½	10.9

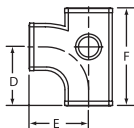

PART NO. NH 32B

**Sanitary Tee with 2'' 45° Sanitary
Opening Above Center
(New Orleans Code)**

Size	D	E	F	G	Weight
3 (L)	6	5	8½	5	8.2
3 (R)	6	5	8½	5	7.8
3 (R&L)	6	5	8½	5	9.1
4 (L)	6½	5½	9¾	5½	9.6
4 (R)	6½	5½	9¾	5½	9.4

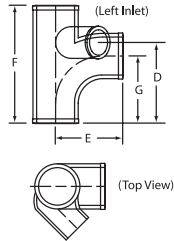

PART NO. NH 33A

**Sanitary Cross with 2'' 90° Sanitary
Openings Above Center
(New Orleans Code)**

Size	C	D	E	F	G	Weight
4	5	6½	5½	9¾	5½	10.8

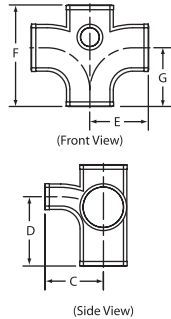

PART NO. NH 33C

**Sanitary Cross with Two 2'' 90°
Sanitary Openings Above Center
(New Orleans Code)**

Size	C	D	E	F	G	Weight
3	4½	6	5	8½	5	9.0
4	5	6½	5½	9¾	5½	11.9

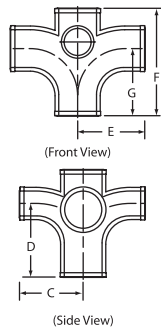

PART NO. NH 33F

**Sanitary Cross with Two 2" 45° Sanitary
Openings Same Side
(New Orleans Code)**

Size	D	E	F	G	Weight
3	6	5	8½	5	9.8
4	5½	5½	9⅛	5½	13.8

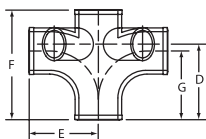

PART NO. NH 33G

**Sanitary Cross with 3" Vent and
Two 2" 45° Inlets**

Size	A	B	C	F	G	Weight
4x3x4x2x2	3¾	5¼	4¾	10½	6½	24.0

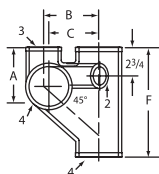
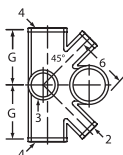

PART NO. NH 34

Sanitary Tapped Tee

Size	D	E	F	Weight
1½ x 1¼	3¼	2 ⁹ / ₁₆	5 ¹¹ / ₁₆	2.3
1½ x 1½	3¼	2 ⁹ / ₁₆	5 ¹¹ / ₁₆	2.5
2 x 1¼	3¼	2 ¹³ / ₁₆	5 ¹¹ / ₁₆	2.8
2 x 1½	3¼	2 ¹³ / ₁₆	5 ¹¹ / ₁₆	3.1
2 x 2	3¾	3 ¹ / ₁₆	6 ³ / ₈	3.8
3 x 1¼	3¼	3 ⁵ / ₁₆	5 ¹¹ / ₁₆	3.7
3 x 1½	3¼	3 ⁵ / ₁₆	5 ¹¹ / ₁₆	3.6
3 x 2	3¾	3 ⁹ / ₁₆	6 ³ / ₈	4.9
3 x 3	4 ⁷ / ₈	4 ¹ / ₈	8	7.3
4 x 1¼	3¼	3 ¹³ / ₁₆	5 ¹¹ / ₁₆	4.0
4 x 1½	3¼	3¾	5 ¹¹ / ₁₆	4.8
4 x 2	3¾	4 ¹ / ₁₆	6 ³ / ₈	5.8
4 x 3	4½	4 ³ / ₈	8	8.4
5 x 1½	3¾	4 ⁵ / ₁₆	7 ³ / ₁₆	6.5
5 x 2	4¼	4 ⁹ / ₁₆	8	9.3
6 x 1½	3¾	4 ¹³ / ₁₆	6¾	8.4
6 x 2	4¼	5 ¹ / ₁₆	7 ⁷ / ₁₆	9.2

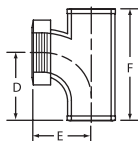

PART NO. EZS 17

**2" x 22⁷/₈" Extended Tapped
Sanitary Tee**

Size	H	F	Weight
2 x 1 ¹ / ₂ x 22 ⁷ / ₈	3 ¹ / ₄	22 ⁷ / ₈	9.6
2 x 2 x 22 ⁷ / ₈	3 ³ / ₄	22 ⁷ / ₈	9.2

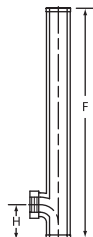

PART NO. EZS 27

Sanitary Tapped Tee

Size	H	F	Weight
2 x 1 ¹ / ₂ x 31	11 ¹ / ₄	31	12.6
2 x 2 x 31	11 ¹ / ₄	31	13.6

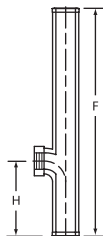

PART NO. NH 35

Sanitary Tapped Cross

Size	D	E	F	Weight
1 ¹ / ₂ x 1 ¹ / ₂	3 ¹ / ₄	2 ⁹ / ₁₆	5 ¹¹ / ₁₆	3.4
2 x 1 ¹ / ₄	3 ¹ / ₄	2 ¹³ / ₁₆	5 ¹¹ / ₁₆	3.9
2 x 1 ¹ / ₂	3 ¹ / ₄	2 ¹³ / ₁₆	5 ¹¹ / ₁₆	4.0
2 x 2	3 ³ / ₄	3 ¹ / ₁₆	6 ³ / ₈	5.3
3 x 1 ¹ / ₂	3 ¹ / ₄	3 ⁵ / ₁₆	5 ¹¹ / ₁₆	4.3
3 x 2	3 ³ / ₄	3 ⁹ / ₁₆	6 ³ / ₈	6.1
4 x 1 ¹ / ₂	3 ¹ / ₄	3 ³ / ₄	5 ¹¹ / ₁₆	5.5
4 x 2	3 ³ / ₄	4 ¹ / ₁₆	6 ³ / ₈	6.9

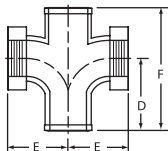

PART NO. EZS 18

**2" x 22⁷/₈" Extended Tapped
Sanitary Cross**

Size	H	F	Weight
2 x 1 ¹ / ₂ x 22 ⁷ / ₈	3 ¹ / ₄	22 ⁷ / ₈	10.0
2 x 2 x 22 ⁷ / ₈	3 ³ / ₄	22 ⁷ / ₈	11.9

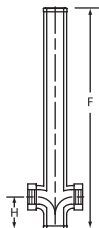

PART NO. EZS 28

Sanitary Tapped Cross

Size	H	F	Weight
2 x 1 ¹ / ₂ x 31	11 ¹ / ₄	31	15.0
2 x 2 x 31	11 ¹ / ₄	31	15.0

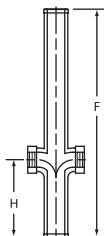

PART NO. NH 35B

**Double Vertical Sanitary
Tapped Tee**

Size	E	F	G	H	Weight
2 x 1 ¹ / ₂	2 ¹³ / ₁₆	9 ³ / ₄	4 ¹ / ₂	3 ¹ / ₄	4.8

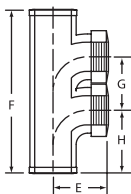

PART NO. NH 36

Test Tee Less Plug

and PART NO. NH 36S

**Test Tee with Southern
Raised-Head Brass Plug Installed
(2" through 8" only)**

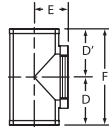

Size	IPS Tap	E	F	D	D'	Weight
2	2	2	6 ³ / ₈	3 ³ / ₁₆	3 ³ / ₁₆	3.0
3	3	2 ¹¹ / ₁₆	7 ³ / ₄	3 ⁷ / ₈	3 ⁷ / ₈	5.8
4	4	3	8 ⁷ / ₈	4 ⁷ / ₁₆	4 ⁷ / ₁₆	9.2
5	5	4 ¹ / ₂	11 ¹ / ₂	5 ³ / ₄	5 ³ / ₄	15.2
6	6	5	12 ¹ / ₂	6 ¹ / ₄	6 ¹ / ₄	22.0
8	8	6	15 ¹ / ₄	7 ⁵ / ₈	7 ⁵ / ₈	37.1
10	10	6 ¹ / ₂	20	10	10	59.7

PART NO. NH 40

Increaser-Reducer

Size	F	Weight
2 x 3	8	3.8
2 x 4	8	4.4
3 x 4	8	5.0

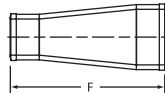

PART NO. NH 40A

Short Reducer

Size	F	Weight
2 x 1½	3 ⁵ / ₈	1.1
3 x 1½	3 ⁵ / ₈	1.8
3 x 2	3 ⁵ / ₈	1.8
4 x 2	3 ⁵ / ₈	2.3
4 x 3	3 ⁵ / ₈	2.3
5 x 2	4	3.3
5 x 3	4	3.8
5 x 4	4	3.2
6 x 2	4	4.3
6 x 3	4	3.7
6 x 4	4	4.1
6 x 5	4½	4.3
8 x 2	4½	7.0
8 x 3	4½	7.6
8 x 4	4½	7.7
8 x 5	5	7.3
8 x 6	5	8.0
10 x 4	5½	12.5
10 x 6	6	13.3
10 x 8	6	14.9
12 x 4	6½	19.1
12 x 6	6½	18.3
12 x 8	7	17.3
12 x 10	7½	18.9
15 x 4	7	30.0
15 x 6	7	31.8
15 x 8	7	32.2
15 x 10	7½	32.2
15 x 12	7¾	30.5



N O - H U B

PART NO. NH 42

P-Trap

Size	D	J	Weight
1½	6¾	3½	3.4
2	7½	4	4.7
3	9	5½	8.9
4	10½	6½	17.0
6	14	8½	33.6

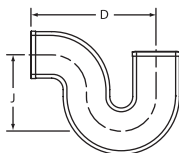

PART NO. NH 42

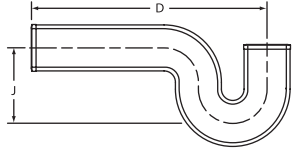

Long P-Trap

Size	D	J	Weight
2 x 12	12	4	6.1
2 x 18	18	4	8.0

PART NO. NH 42A

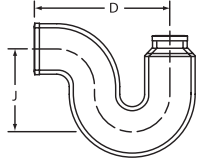

P-Trap, Reducing

Size	D	J	Weight
3 x 2	9	5 1/2	10.0

PART NO. NH 42B

P Trap with 1/2" Tap in Heel

Size	C	D	E	J	Weight
6	8	14	2 3/4	8 1/2	33.6

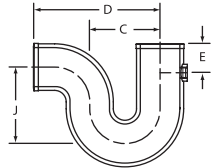

PART NO. NH 43

P Trap with 1/2" Tap in Heel

Size	C	D	E	J	Weight
2	4	7 1/2	2	4	4.7
3	5	9	2	5 1/2	10.8
4	6	10 1/2	2	6 1/2	18.8

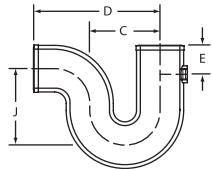

PART NO. EZS 9

P-Trap with 1 1/2" Tapped Side Inlet

Size	H	F	Weight
2	5 3/16	7 1/2	6.2

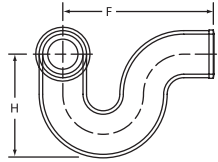

(Illustration Shows Right Hand)

PART NO. EZS 10

P-Trap with 2" Side Inlet

Size	C	D	J	Weight
2	1 3/16	7 1/2	3 1/16	6.4

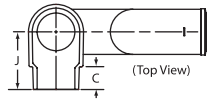

(Top View)

(Side View)

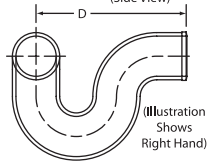

(Illustration Shows Right Hand)

PART NO. NH 44

P-Trap with Tapped Inlet

Size	C	D	J	Weight
1 1/2 x 1 1/2	3 1/2	6 3/4	3 1/2	3.0
2 x 1 1/2	4	7 1/2	4	4.5
2 x 2	4	7 1/2	4	5.4

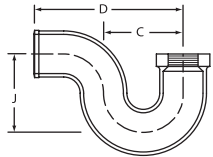

PART NO. NH 44A

Deep Seal P Trap

Size	C	D	J	Weight
2	4	7 1/2	7	6.6
3	5	9	7	11.0
4	6	10 1/2	8	18.6

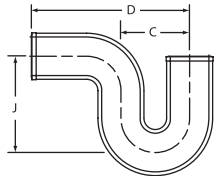

PART NO. NH 45

Running Trap with Vent

Size	D	E	F	G	Weight
4	6½	4½	15	10½	20.5

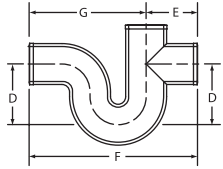

PART NO. NH 45A

Running Trap with Double Vent

Size	C	D	E	F	G	Weight
4	6	6½	4½	15	10½	21.4

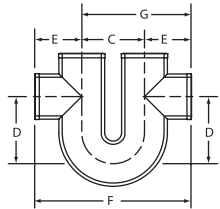

PART NO. EZS 13

45° Vented Tub Wye

Size	E	F	G	Weight
2	12	5¼	15¾	10.1

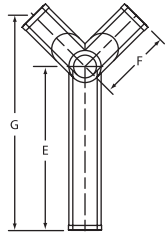

PART NO. EZS 38

Vented Tub Wye

Size	G	H	F	Weight
2	9½	5¼	15	9.4
2	24	5¼	29½	13.7

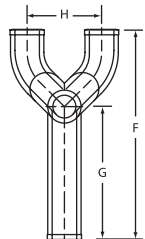

PART NO. EZS 38 L

**Vented Tub Wye
Left Hand**

Size	G	H	F	Weight
2	9 ¹ / ₂	3 ³ / ₄	15	10.0

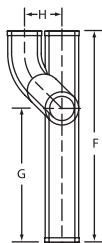

PART NO. EZS 38 R

**Vented Tub Wye
Right Hand**

Size	G	H	F	Weight
2	9 ¹ / ₂	3 ³ / ₄	15	9.0

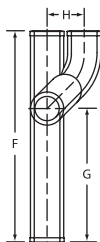

PART NO. NH 48

Tapped Adapters

Size	F	IPS Tapping	Weight
1 ¹ / ₂ x 1 ¹ / ₂	2 ⁵ / ₈	1 ¹ / ₂	1.3
2 x 1 ¹ / ₄	2 ³ / ₁₆	1 ¹ / ₄	1.0
2 x 1 ¹ / ₂	2 ³ / ₁₆	1 ¹ / ₂	0.9
2 x 2	2 ⁵ / ₈	2	1.7
3 x 2	2 ³ / ₁₆	2	1.0

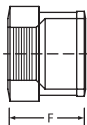

PART NO. NH 50

Blind Plug

Size	F	Weight
1½	1¾	0.6
2	1¾	0.7
3	1¾	1.1
4	1¾	2.0
5	1¾	2.9
6	1¾	3.2
8	2¼	6.5
10	3	14.7
12	3½	17.6
15	3½	28.0

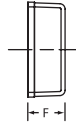

PART NO. NH 52

**Tapped Ferrule Less Brass Plug
and PART NO. NH 52S**

**Tapped Ferrule with Southern
Raised-Head Brass Plug Installed**

Size	F	IPS	
		Tapping	Weight
2	2 ³ / ₁₆	1½	0.9
3	2 ³ / ₁₆	2½	1.9
4	2 ³ / ₁₆	3½	2.5
5	4½	4	6.5
6	4½	5	8.0
8	4½	6	12.1

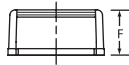

PART NO. NH 53

Single Two-Way Cleanout

Size	E	F	Weight
4	7½	15	16.0

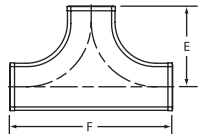

PART NO. NH 53A

Two-Way Cleanout

Size	D	E	F	G	Weight
4	8¼	2¾	12	6½	15.0

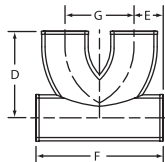

PART NO. NH 54

Two-Way Baffle Cleanout

Size	D	F	Weight
3 x 3 x 4	15	9	14.2
4 x 4 x 4	18 ³ / ₈	9 ¹ / ₂	22.0

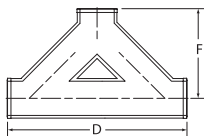

PART NO. NH 56

Notched and Slotted Closet Collar

Size	D	E	F	A	Weight
4 x 3	3 ¹ / ₂	3 ³ / ₈	7 ¹ / ₄	4 ⁷ / ₃₂	3.3
4 x 3	8	3 ²⁷ / ₆₄	7 ¹ / ₄	4	6.1
4 x 4	4	4 ³ / ₈	7 ¹ / ₄	4 ⁹ / ₆₄	4.7
4 x 4	8	4 ³ / ₈	7 ¹ / ₄	4 ⁷ / ₃₂	7.0

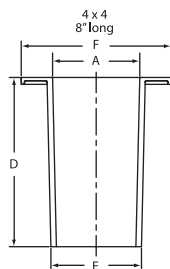
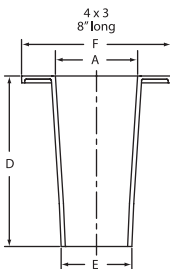
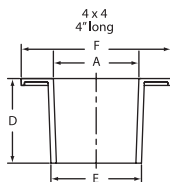
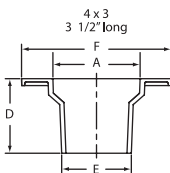

PART NO. NH 57

Horizontal Twin Tapped Tee

Size	A	D	F	H	Weight
3 x 1 ¹ / ₂	1 ³ / ₈	4	7	3	7.3
4 x 1 ¹ / ₂	1 ³ / ₈	4	7	3	8.0

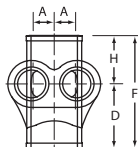

PART NO. NH 457

**Vented Closet Tee
with 2" Top Vent**

(Left or Right; Designed for use below the floor;
Fitting does not require a baffle)

Size	B	C	D	E	F	G	Wt.
4x4x2x4(L)	4 1/4	5 1/4	3 3/4	4	10 1/2	3 3/4	12.1
4x4x2x4(R)	4 1/4	5 1/4	3 3/4	4	10 1/2	3 3/4	11.6

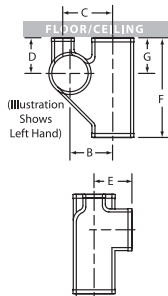

PART NO. NH 458[‡]

Vented Closet Tee

with 2" Top Vent and 2" Side Opening

(Left or Right; Designed for use below the floor;
Fitting does not require a baffle)

Size	A	B	C	D	E	F	G	Wt.
4x4x2x2x4(L)	8 1/8	4 1/4	5 1/4	7 1/2	4	10 1/2	3 3/4	12.3
4x4x2x2x4(R)	8 1/8	4 1/4	5 1/4	7 1/2	4	10 1/2	3 3/4	12.2

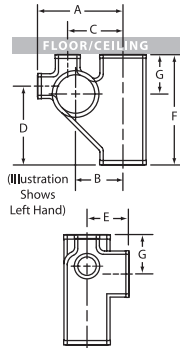

PART NO. NH 463

Vented Closet Cross with 2" Top Vent

(Designed for use below the floor;
Fitting has a baffle)

Size	B	C	D	E	F	G	Wt.
4x4x2x4x4	4 1/4	5 1/4	3 3/4	4	10 1/2	3 3/4	15.0

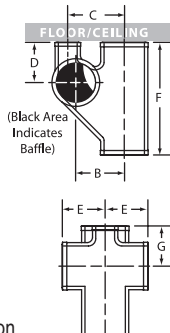

[‡] Additional drawing available in Detail Drawing Section

PART NO. NH 464

**Vented Closet Cross with 2" Top Vent
and 2" Side Opening**
(Designed for use below the floor;
Fitting has a baffle)

Size	A	B	C	D	E	F	G	Wt.
4x4x2x2x4x4	8 ¹ / ₈	4 ¹ / ₄	5 ¹ / ₄	7 ¹ / ₂	4	10 ¹ / ₂	3 ³ / ₄	15.6

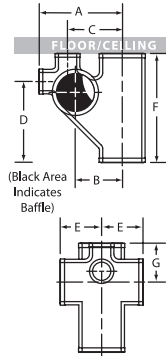

PART NO. NH 502†

4" No Hub Prison Fitting with 2" Top Vent
(Designed for use above the floor; Baffle helps prevent
passage of contraband between cells)

Part No.	Size	UPC# 611942-	A	C	F	G	Weight
NH 502	4 Less Tap	00639	8	5 1/4	12	8	20.3
NH 502	4 With Tap	00640	8	5 1/4	12	8	20.8
NH 502	4x3 Less Tap	11119	8	5 1/4	12	8	23.4
NH 502	4x3 With Tap	11120	8	5 1/4	12	8	23.4

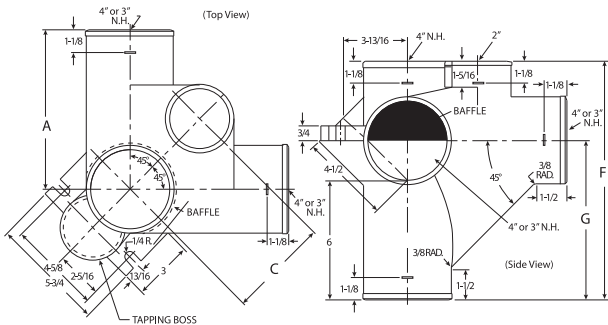

† Additional drawing available in Detail Drawing Section

PART NO. EZS 50*

10'' Closet Fittings with 2'' Inlet
(Double, Left Hand or Right Hand; Designed for use below the floor;
Fitting does not have a baffle)

Part No.	Size	UPC# 611942-	A	B	C	D	F	Weight
EZS 50D***	4	04484	10 ³ / ₄	6 ¹ / ₂	3 ³ / ₄	4	4 ¹ / ₂	15.0
EZS 50L	4	04476	10 ³ / ₄	6 ¹ / ₂	3 ³ / ₄	4	4 ¹ / ₂	12.3
EZS 50R	4	04477	10 ³ / ₄	6 ¹ / ₂	3 ³ / ₄	4	4 ¹ / ₂	12.2

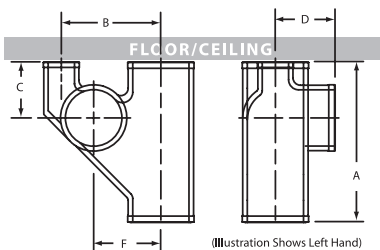

PART NO. EZS 51*

10'' Closet Fittings with 2'' Inlet and 2'' Side Inlet
(Double, Left Hand or Right Hand; Designed for use below the floor;
Fitting does not have a baffle)

Part No.	Size	UPC# 611942-	A	B	C	D	E	F	Weight
EZS 51D***	4	04424	10 ³ / ₄	6 ¹ / ₂	3	4	9 ¹ / ₂	4 ¹ / ₂	15.0
EZS 51L	4	04425	10 ³ / ₄	6 ¹ / ₂	3	4	9 ¹ / ₂	4 ¹ / ₂	12.8
EZS 51R	4	04473	10 ³ / ₄	6 ¹ / ₂	3	4	9 ¹ / ₂	4 ¹ / ₂	12.6

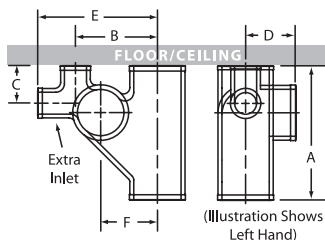

* When ordering please specify Double, Left or Right.

*** Double closet fitting does not have a baffle.

HOW TO DETERMINE RIGHT or LEFT HAND CROSS-OVER



With the vented end toward you, hold the fitting so that you are looking into its length with the curved side up. If the vent is on your left side, it is a Left Hand fitting. If the vent is on your right side, it is a Right Hand fitting.

RIGHT HAND CROSS-OVER ILLUSTRATED

Note: VENT CROSS-OVER
for use with EZS-50 through 800 Series fittings.
Specify Right, Left, Plain or Double.

Note: Our crossovers are designed for use with EZS starter fittings, that is for the vent and stack centerline to be 6½"

PART NO. EZS 7

2" Vent Cross-Over, Plain (No Outlets)

U.P.C. No.	Size	A	C	F	Weight
04429	2 x 18 ³ / ₈	4 ⁷ / ₈	9 ³ / ₁₆	18 ³ / ₈	8.1

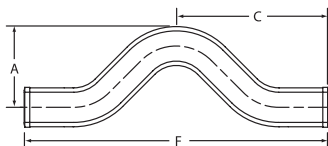

PART NO. EZS 7D

2" Vent Cross-Over, Double (2 Inlets)

U.P.C. No.	Size	A	B	C	F	Weight
04430	2 x 18 ³ / ₈	4 ⁷ / ₈	6 ¹ / ₂	9 ³ / ₁₆	18 ³ / ₈	8.0

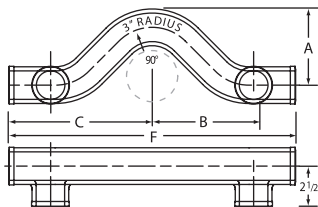

PART NO. EZS 7L

**2" Vent Cross-Over
with Left Hand Inlet**

U.P.C. No.	Size	A	B	C	F	Weight
611942						
04431	2 x 18 ³ / ₈	4 ⁷ / ₈	6 ¹ / ₂	9 ³ / ₁₆	18 ³ / ₈	8.2

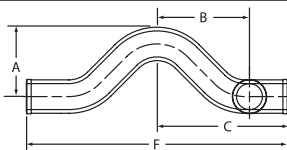

PART NO. EZS 7R

**2" Vent Cross-Over
with Right Hand Inlet**

U.P.C. No.	Size	A	B	C	F	Weight
611942						
04432	2 x 18 ³ / ₈	4 ⁷ / ₈	6 ¹ / ₂	9 ³ / ₁₆	18 ³ / ₈	8.4

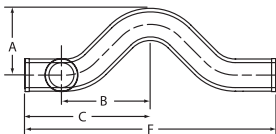

PART NO. EZS 1

Figure One

Size	E	F	D	Weight
2 x 1 ¹ / ₂	3 ³ / ₁₆	7	4 ⁷ / ₈	5.3

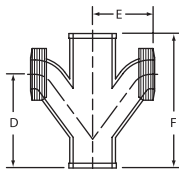

PART NO. NH 25

Figure Five Double Fixture Fitting

Size	D	E	F	G	Weight
2	6 ¹ / ₂	5	8	1 ³ / ₁₆	7.0
3	8 ⁷ / ₈	6 ⁹ / ₁₆	10 ¹ / ₈	2	10.5
3 x 2 x 3 x 3	8 ⁷ / ₈	6 ⁹ / ₁₆	9 ¹ / ₄	2	10.7
4	10 ¹ / ₄	7 ³ / ₄	12	1 ⁵ / ₁₆	22.5
4 x 2 x 4 x 4	10 ¹ / ₄	7 ³ / ₄	11 ¹ / ₂	1 ⁵ / ₁₆	19.8

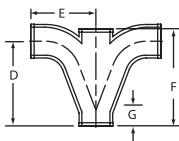

NO-HUB

PART NO. EZS 6*

Figure Six

(Double, Left Hand or Right Hand; Designed for use below the floor)

Part No.	Size	C	D	E	F	H	Weight
EZS 6D**	3x2	4 ¹ / ₈	7 ⁹ / ₁₆	5 ¹ / ₁₆	11	3 ⁷ / ₁₆	13.0
EZS 6D**	4x2	4 ¹ / ₂	9	6 ¹ / ₂	13	4	23.1
EZS 6L	3x2	4 ¹ / ₈	7 ⁹ / ₁₆	5 ¹ / ₁₆	11	3 ⁷ / ₁₆	11.4
EZS 6L	4x2	4 ¹ / ₂	9	6 ¹ / ₂	13	4	18.0
EZS 6R	3x2	4 ¹ / ₈	7 ⁹ / ₁₆	5 ¹ / ₁₆	11	3 ⁷ / ₁₆	11.4
EZS 6R	4x2	4 ¹ / ₂	9	6 ¹ / ₂	13	4	18.0

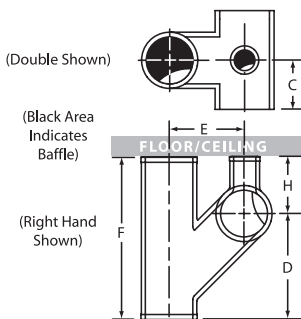

* When ordering please specify Double, Left or Right.

** Double fitting has a baffle.

PART NO. EZS 8*

Figure Eight

(Double, Left Hand or Right Hand; Designed for use below the floor)

Part No.	Size	C	D	E	F	H	Weight
EZS 8D**	3x2	4 ¹ / ₈	7 ⁹ / ₁₆	5 ¹ / ₁₆	11	3 ⁷ / ₁₆	13.0
EZS 8L	3x2	4 ¹ / ₈	7 ⁹ / ₁₆	5 ¹ / ₁₆	11	3 ⁷ / ₁₆	12.5
EZS 8L	4x2	4 ¹ / ₂	9	6 ¹ / ₂	13	4	19.8
EZS 8R	3x2	4 ¹ / ₈	7 ⁹ / ₁₆	5 ¹ / ₁₆	11	3 ⁷ / ₁₆	12.5
EZS 8R	4x2	4 ¹ / ₂	9	6 ¹ / ₂	13	4	19.8

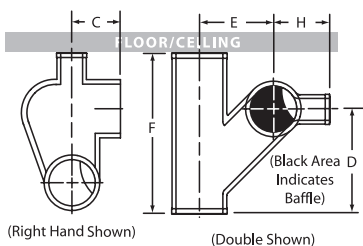

PART NO. EZS 8A

Figure Eight Double Fixture Fitting, Extended**

(Designed for Use Below the Floor)

Size	D	E	F	H	Weight
4 x 2	9	6 ¹ / ₂	13	8	23.4

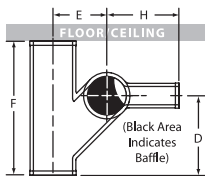

* When ordering please specify Double, Left or Right.

** Double fitting has a baffle.

PART NO. EZS 100*

16" Closet Fittings with 2" Inlets

(Double, Left Hand or Right Hand; Designed for use below the floor)

Part No.	Size	A	B	C	D	E	M	Weight
EZS 100D	4x16	16 ³ / ₄	5	4 ¹ / ₂	6 ¹ / ₂	5 ¹ / ₂	5	22.0
EZS 100L	4x16	16 ³ / ₄	5	4 ¹ / ₂	6 ¹ / ₂	5 ¹ / ₂	5	20.0
EZS 100R	4x16	16 ³ / ₄	5	4 ¹ / ₂	6 ¹ / ₂	5 ¹ / ₂	5	21.1

N
O
-
H
U
B

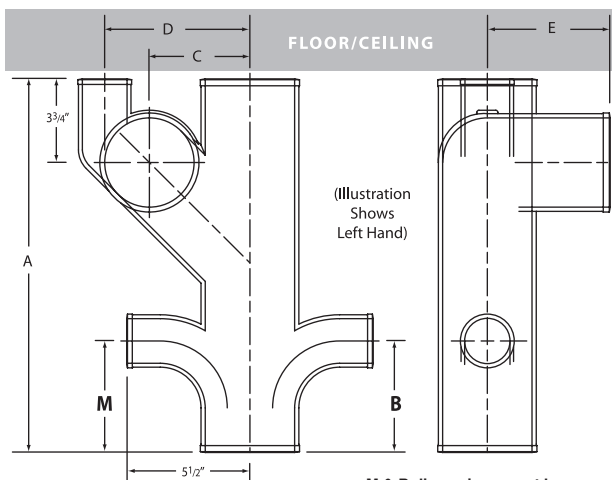

M & B dimensions must be measured from the bottom of the fitting.

* When ordering please specify Double, Left or Right.

PART NO. EZS 400*†
30" Closet Fittings with 2" Inlet
[Double, Left Hand or Right Hand; Designed for use in the floor]

Part No.	Size	A	B	C	D	E	M	Weight
EZS 400L	4x30	30	0	4½	6½	5½	0	34.0
EZS 400L	4x30	30	6½	4½	6½	5½	0	34.2
EZS 400L	4x30	30	12	4½	6½	5½	0	37.8
EZS 400L	4x30	30	26½	4½	6½	5½	0	34.3
EZS 400L	4x30	30	0	4½	6½	5½	4	34.0
EZS 400L	4x30	30	26½	4½	6½	5½	4	34.0
EZS 400L	4x30	30	0	4½	6½	5½	6½	33.1
EZS 400L	4x30	30	6½	4½	6½	5½	6½	34.0
EZS 400L	4x30	30	26½	4½	6½	5½	6½	36.8
EZS 400L	4x30	30	0	4½	6½	5½	12	31.0
EZS 400L	4x30	30	26½	4½	6½	5½	12	30.0
<hr/>								
EZS 400R	4x30	30	0	4½	6½	5½	0	32.9
EZS 400R	4x30	30	6½	4½	6½	5½	0	34.5
EZS 400R	4x30	30	12	4½	6½	5½	0	37.1
EZS 400R	4x30	30	26½	4½	6½	5½	0	33.8
EZS 400R	4x30	30	0	4½	6½	5½	4	34.0
EZS 400R	4x30	30	26½	4½	6½	5½	4	28.9
EZS 400R	4x30	30	0	4½	6½	5½	6½	33.9
EZS 400R	4x30	30	6½	4½	6½	5½	6½	35.4
EZS 400R	4x30	30	26½	4½	6½	5½	6½	35.4
EZS 400R	4x30	30	0	4½	6½	5½	12	31.0
EZS 400R	4x30	30	26½	4½	6½	5½	12	28.5

(EZS 400 is continued on the following page.)

* When ordering please specify Double, Left or Right.

† Additional drawing available in Detail Drawing Section

PART NO. EZS 400, continued

Part No.	Size	A	B	C	D	E	M	Weight
EZS 400D	4x30	30	0	4 1/2	6 1/2	5 1/2	0	29.3
EZS 400D	4x30	30	6 1/2	4 1/2	6 1/2	5 1/2	0	36.4
EZS 400D	4x30	30	12	4 1/2	6 1/2	5 1/2	0	39.6
EZS 400D	4x30	30	0	4 1/2	6 1/2	5 1/2	4	38.0
EZS 400D	4x30	30	0	4 1/2	6 1/2	5 1/2	6 1/2	35.6
EZS 400D	4x30	30	26 1/2	4 1/2	6 1/2	5 1/2	6 1/2	38.9
EZS 400D	4x30	30	0	4 1/2	6 1/2	5 1/2	12	35.7
EZS 400D	4x30	30	26 1/2	4 1/2	6 1/2	5 1/2	12	38.0

N O N H U B

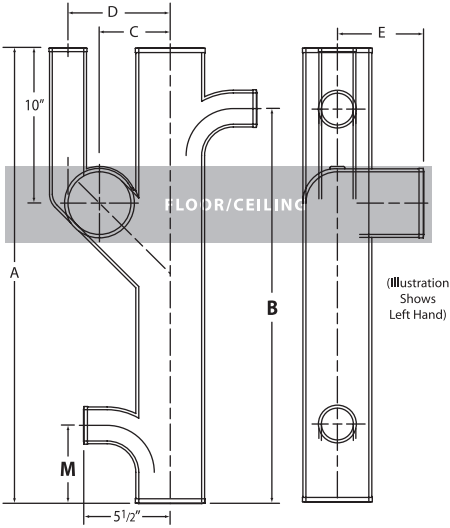

PART NO. EZS 700†**

Threaded Starter Fitting with or without No-Hub Inlets
(Double, Left Hand or Right Hand; Designed for use above the floor with back-outlet water closets; Double Starter fittings have a baffle)

Part No.	Size	A	B	C	D	E	Weight
EZS 700D**	4x28	0	0	5½	28	6½	40.0
EZS 700D**	4x28	0	8½	5½	28	6½	42.0
EZS 700D**	4x28	23½	8½	5½	28	6½	42.0
EZS 700L	4x28	0	0	5½	28	6½	34.6
EZS 700L	4x28	0	8½	5½	28	6½	35.7
EZS 700L	4x28	14	8½	5½	28	6½	36.3
EZS 700L	4x28	23½	8½	5½	28	6½	32.0
EZS 700R	4x28	0	0	5½	28	6½	30.0
EZS 700R	4x28	0	8½	5½	28	6½	34.0
EZS 700R	4x28	14	8½	5½	28	6½	35.3
EZS 700R	4x28	23½	8½	5½	28	6½	32.0

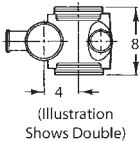
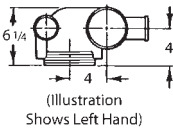

A & B Dimensions must be measured from the top of the fitting.

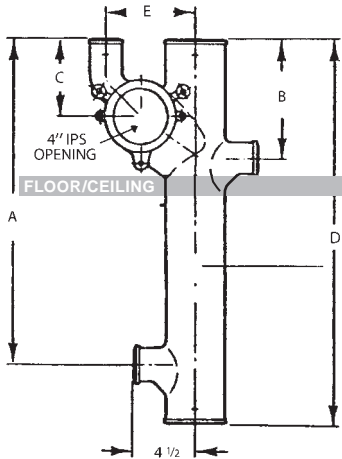

* When ordering please specify Double, Left or Right.

2" inlets available

** Double starter fittings have a baffle.

Note: Trim package not included in price of fitting

“0” dimension denotes the absence of the designated inlet.

† Additional drawing available in Detail Drawing Section

PART NO. EZS 800*†

Threaded Starter Fitting with or without No-Hub Inlets
(Double, Left Hand or Right Hand; Designed for use above the floor with back-outlet water closets; Double starter fittings have a baffle)

Part No.	Size	A	B	C	D	E	Weight
EZS 800D**	4x28	16	0	5½	28	6½	42.0
EZS 800D**	4x28	16	8½	5½	28	6½	42.0
EZS 800L	4x28	16	0	5½	28	6½	35.4
EZS 800L	4x28	16	8½	5½	28	6½	36.3
EZS 800R	4x28	16	0	5½	28	6½	35.6
EZS 800R	4x28	16	8½	5½	28	6½	35.3

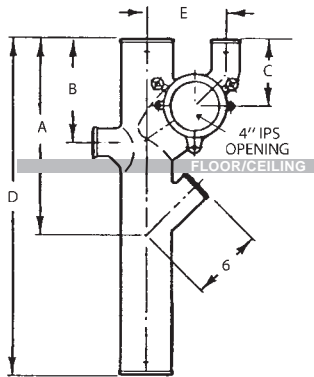
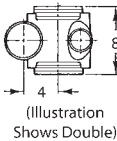
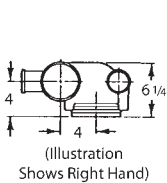

2" inlets available

A & B Dimensions must be measured from the top of the fitting.

* When ordering please specify Double, Left or Right.

** Double starter fittings have a baffle.

Note: Trim package not included in price of fitting

“0” dimension denotes the absence of the designated inlet.

† Additional drawing available in Detail Drawing Section

PART NO. EZS 710*

No-Hub Starter Fitting with or without 2" No-Hub Inlets
(Double, Left Hand or Right Hand; Designed for use above the floor with back-outlet water closets; Double starter fittings have a baffle)

Part No.	Size	A	B	C	D	E	Weight
EZS 710D**	4x28	0	0	5 1/2	28	4	43.0
EZS 710D**	4x28	0	8 1/2	5 1/2	28	4	43.0
EZS 710D**	4x28	23 1/2	8 1/2	5 1/2	28	4	43.0
EZS 710L	4x28	0	0	5 1/2	28	4	36.6
EZS 710L	4x28	0	8 1/2	5 1/2	28	4	36.6
EZS 710L	4x28	14	8 1/2	5 1/2	28	4	36.6
EZS 710L	4x28	23 1/2	8 1/2	5 1/2	28	4	36.6
EZS 710R	4x28	0	0	5 1/2	28	4	36.6
EZS 710R	4x28	0	8 1/2	5 1/2	28	4	36.6
EZS 710R	4x28	14	8 1/2	5 1/2	28	4	36.6
EZS 710R	4x28	23 1/2	8 1/2	5 1/2	28	4	36.6

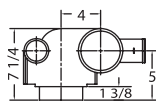

(Illustration Shows Left Hand)

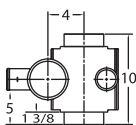

(Illustration Shows Double)

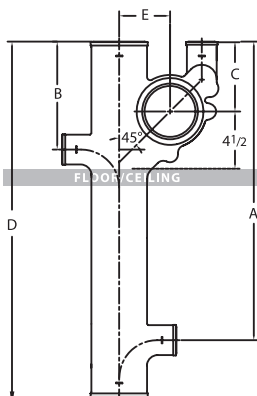

2" inlets available

A & B Dimensions must be measured from the top of the fitting.

* When ordering please specify Double, Left or Right.

** Double starter fittings have a baffle.

Note: Not designed for use with trim package

“0” dimension denotes the absence of the designated inlet.

PART NO. EZS 810*

No-Hub Starter Fitting with or without 2" No-Hub Inlets
(Double, Left Hand or Right Hand; Designed for use above the floor with back-outlet water closets; Double starter fittings have a baffle)

Part No.	Size	A	B	C	D	E	Weight
EZS 810D**	4x28	16	0	5 1/2	28	6 1/2	43.0
EZS 810D**	4x28	16	8 1/2	5 1/2	28	6 1/2	43.0
EZS 810L	4x28	16	0	5 1/2	28	6 1/2	36.6
EZS 810L	4x28	16	8 1/2	5 1/2	28	6 1/2	36.6
EZS 810R	4x28	16	0	5 1/2	28	6 1/2	36.6
EZS 810R	4x28	16	8 1/2	5 1/2	28	6 1/2	36.6

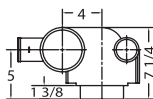

(Illustration Shows Right Hand)

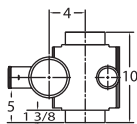

(Illustration Shows Double)

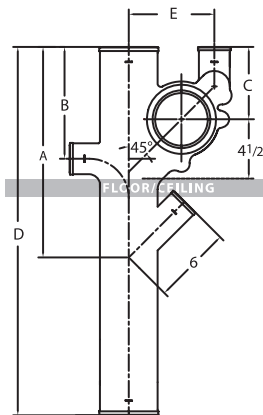

2" inlets available

A & B Dimensions must be measured from the top of the fitting.

* When ordering please specify Double, Left or Right.

** Double starter fittings have a baffle.

Note: Not designed for use with trim package

“0” dimension denotes the absence of the designated inlet.

MOUNTING HARDWARE

PART NO. EZS 22
Trim Package, Support Frame Assembly

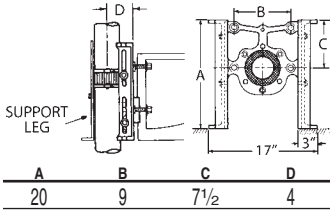

- 1—FRAME
- 1—LEFT LEG
- 1—RIGHT LEG
- 1—SUPPORT LEG (used for single only)
- 5—1/2" x 1 1/4" BOLTS
- 5—1/2" FLAT WASHERS

PART NO. EZS 23
Trim Package, Floor-Mounted Back-Outlet Assembly
(Note: Not to be used with PART NO. EZS 22 Support Frame Assembly)

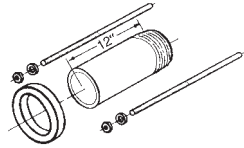

- 1—4" PVC Sch. 80 NIPPLE with TEST CAP
- 1—BOWL GASKET
- 2—5/16" x 12" RODS
- 2—5/16" HEX NUTS
- 2—5/16" FLAT WASHERS
- 2—5/16" CAP NUTS

PART NO. EZS 24
Trim Package, Wall-Hung Back-Outlet Assembly
(Note: To be used with PART NO. EZS 22 Support Frame Assembly)

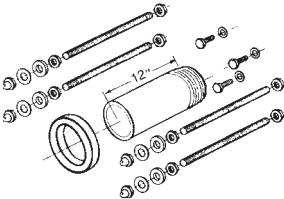

- 1—4" PVC Sch. 80 NIPPLE with TEST CAP
- 1—BOWL GASKET
- 4—5/8" x 12" RODS
- 4—5/8" CHROME CAP NUTS
- 8—5/8" JAM NUTS
- 4—5/8" FLAT WASHERS
- 4—5/8" FIBER WASHERS
- 3—3/8" x 1 1/2" BOLTS FOR FACEPLATE
- 3—3/8" FLAT WASHERS
- 4—5/8" STAR WASHERS

Exploded View of Support Assembly Hardware

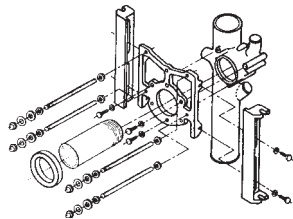

EZS 22 and EZS 24 Assemblies Illustrated

TYPICAL HIGH-RISE BUILDING INSTALLATION

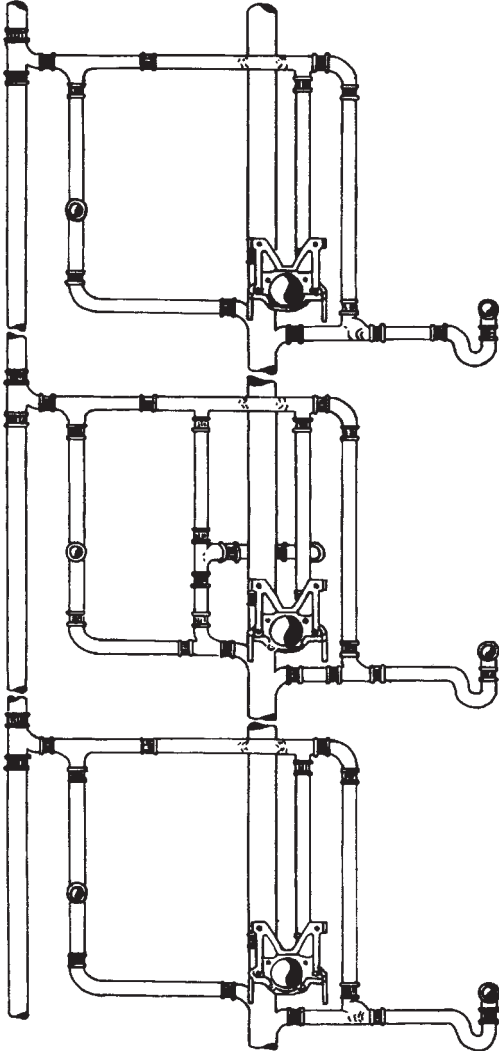

N
O
·
H
U
B

TYPICAL BACK-TO-BACK INSTALLATION

Typical installation shows back-to-back water closets and back-outlet tubs. This system can be changed to use floor-mounted back-outlet water closets and bottom-outlet tubs.

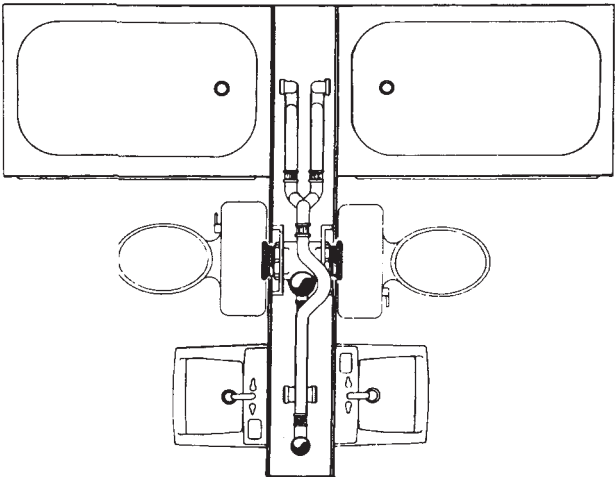
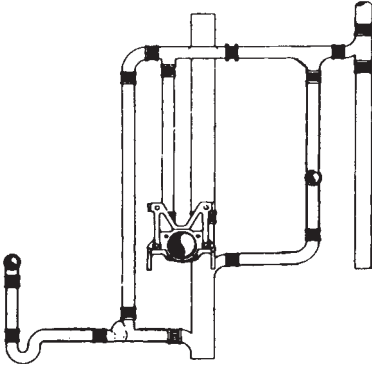

PART NO. EZS 400D

**Charlotte Pipe Starter Fitting
4x30 Closet Fitting Double - M Inlet 0; B Inlet 6 1/2"**

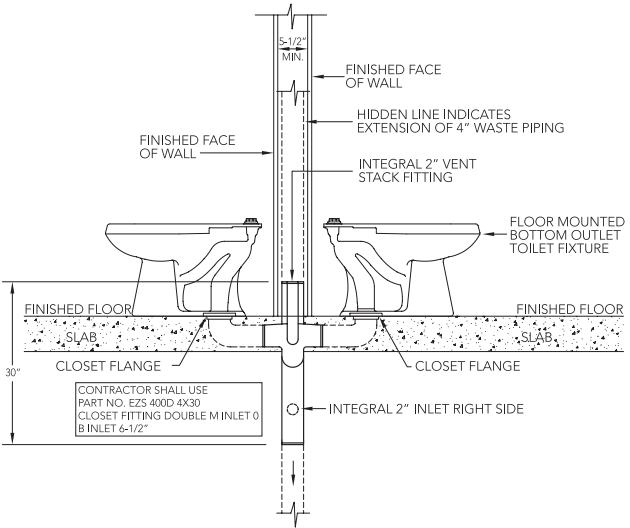

N
O
H
U
B

PART NO. EZS 700D

**Charlotte Pipe Starter Fitting
4x28 Threaded Double - A Inlet 0; B Inlet 8 1/2"
with EZS 22 Support Frame and EZS 24 Trim Package**

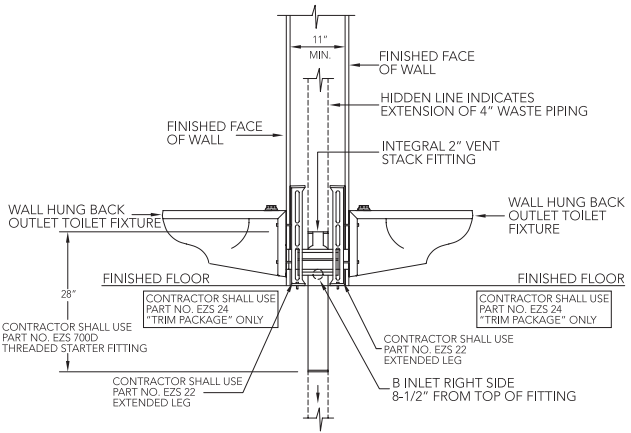

DOUBLE FITTING - LEFT SIDE ELEVATION

PART NO. EZS 700R

**Charlotte Pipe Starter Fitting
4x28 Threaded Right Hand - A Inlet 0; B Inlet 0
with EZS 23 Trim Package**

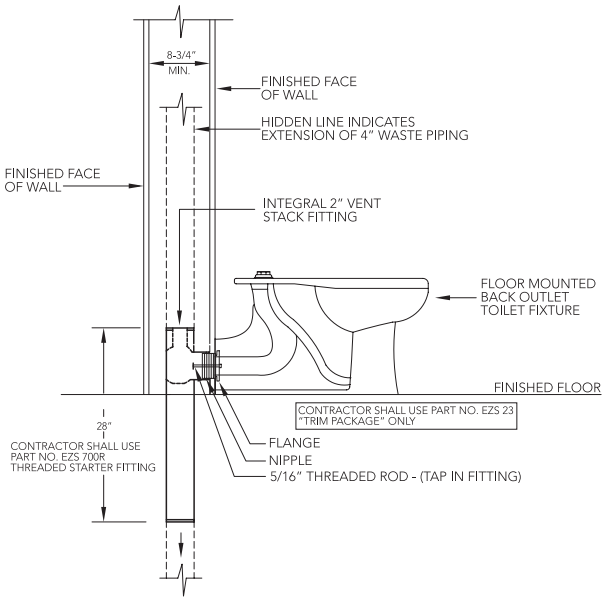

DETAIL DRAWINGS

RIGHT HAND FITTING - LEFT SIDE ELEVATION

PART NO. EZS 800D

**Charlotte Pipe Starter Fitting
4x28 Threaded Double - A Inlet 16; B Inlet 0
with EZS 23 Trim Package**

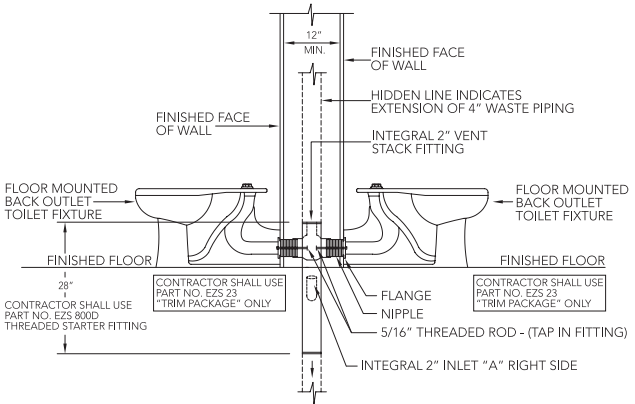

DOUBLE FITTING - LEFT SIDE ELEVATION

PART NO. EZS 800L

**Charlotte Pipe Starter Fitting
4x28 Threaded Left Hand - A Inlet 16; B Inlet 0
with EZS 22 Support Frame and EZS 24 Trim Package**

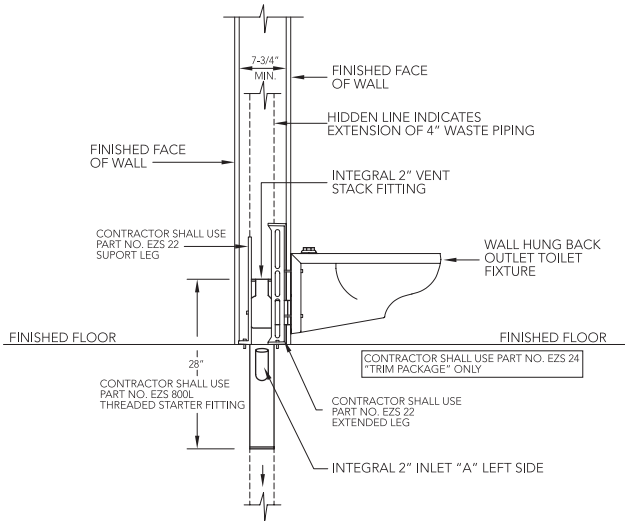

DETAIL DRAWINGS

LEFT HAND FITTING - LEFT SIDE ELEVATION

PART NO. NH 458

**Charlotte Pipe Starter Fitting
4x4x2x2x4 Vented Closet Tee, Left Hand,
with 2" Top Vent and 2" Side Inlet**

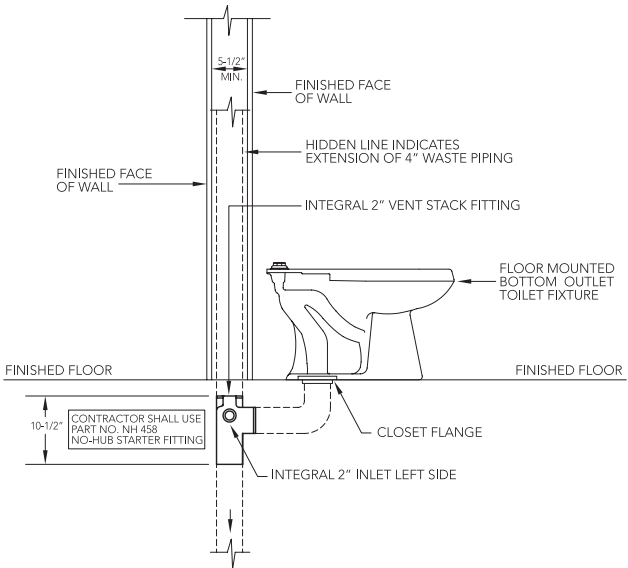

SINGLE FITTING LEFT HAND UNDER-SLAB - LEFT SIDE ELEVATION

PART NO. NH 502

**Charlotte Pipe Starter Fitting
4" No-Hub with 2" Top Vent and 2" 45° Tap Service
for Two Cells at 45° Angle**

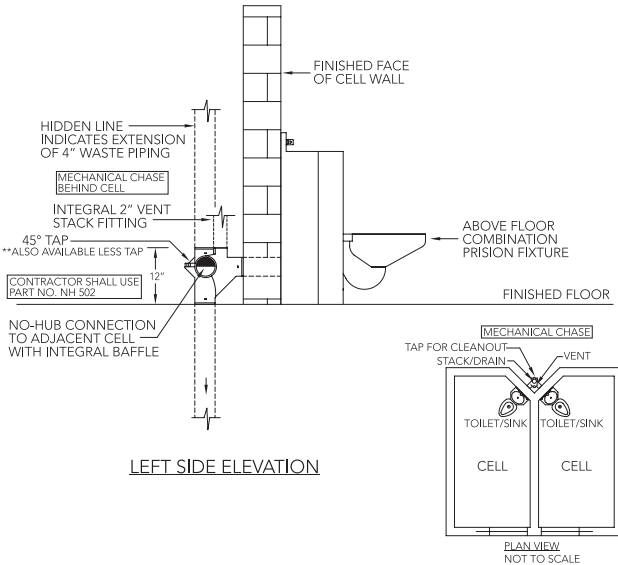

**DETAIL
DRAWINGS**

Service

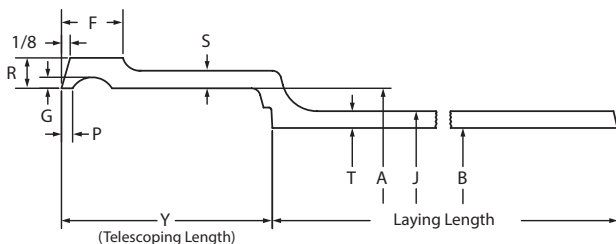

PIPE - SERVICE*

Size	Telescoping Length	Hub I.D.	O.D.	Barrel I.D.	Nominal Thickness
	Y	A	J	B	T
2"	2.50	2.94	2.30	1.96	0.17
3"	2.75	3.94	3.30	2.96	0.17
4"	3.00	4.94	4.30	3.94	0.18
5"	3.00	5.94	5.30	4.94	0.18
6"	3.00	6.94	6.30	5.94	0.18
8"	3.50	9.25	8.38	7.94	0.23
10"	3.50	11.38	10.50	9.94	0.28
12"	4.24	13.50	12.50	11.94	0.28
15"	4.25	16.95	15.88	15.16	0.36

CHARLOTTE® SPEED-PAK FIVE FOOT PIPE BUNDLES

SERVICE				
	SIZE	PIECES	WEIGHT	HEIGHT
Single Hub	2"	100	2248	20"
	3"	60	1910	22"
	4"	46	1904	25"
	5"	33	1750	31"
	6"	23	1591	31"
	8"	11	1128	30"
	10"	8	1226	27"
	12"	6	1114	31"
Double Hub	15"	2	575	34"
	2"	100	2113	23"
	3"	60	1914	24"
	4"	46	1956	25"
	5"	33	1888	35"
	6"	23	1598	35"

* For additional dimensional information please see the Cast Iron Technical and Installation Manual.

CHARLOTTE® SPEED-PAK
30" SINGLE HUB PIPE BUNDLES

SERVICE				
30" Single Hub	SIZE	PIECES	WEIGHT	HEIGHT
	8 x 30"	11	645	24"
	10 x 30"	8	733	24"
	12 x 30"	6	643	28"
	15 x 30"	2	333	34"

TEN FOOT PIPE BUNDLES

SERVICE				
Single Hub	SIZE	PIECES	WEIGHT	HEIGHT
	2 x 10'	54	2165	12"
	3 x 10'	36	2141	15"
	4 x 10'	27	2028	18"
	5 x 10'	24	2409	20"
	6 x 10'	18	2211	23"
	8 x 10'	8	1444	22"
	10 x 10'	6	1558	27"
	12 x 10'	6	2075	30"
	15 x 10'	2	1050	23"

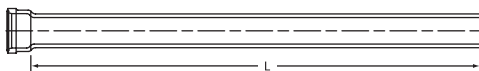
PART NO. SV 1

Pipe, 5' Lengths, Single Hub

Size	L	Weight
2" x 5'	5'	23.8
3" x 5'	5'	31.8
4" x 5'	5'	41.0
5" x 5'	5'	52.5
6" x 5'	5'	69.2
8" x 5'	5'	101.0
10" x 5'	5'	150.9
12" x 5'	5'	185.7
15" x 5'	5'	302.7

Weights are approximate and are for shipping purposes only.

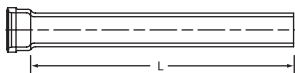
PART NO. SV 1A



Pipe, 30" Lengths, Single Hub

Size	L	Weight
8" x 30"	30"	58.7
10" x 30"	30"	91.7
12" x 30"	30"	107.1
15" x 30"	30"	166.3

PART NO. SV 2

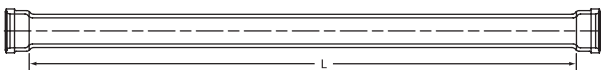

Pipe, 5' Lengths, Double Hub

Size	L	Weight
2" x 5'	4' 9 1/2"	21.1
3" x 5'	4' 9 1/4"	31.9
4" x 5'	4' 9"	42.5
5" x 5'	4' 9"	57.2
6" x 5'	4' 9"	69.5

PART NO. SV 3

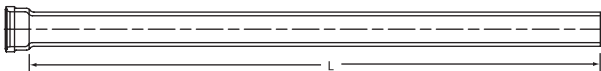

Pipe, 10' Lengths, Single Hub

Size	L	Weight
2" x 10'	10'	40.1
3" x 10'	10'	59.5
4" x 10'	10'	75.1
5" x 10'	10'	100.4
6" x 10'	10'	122.8
8" x 10'	10'	180.5
10" x 10'	10'	276.1
12" x 10'	10'	345.9
15" x 10'	10'	525.1

PART NO. SV 4

Pipe, 30" Lengths, Double Hub

Size	L	Weight
2" x 30"	25"	13.8
3" x 30"	24 1/2"	17.6
4" x 30"	24"	27.1

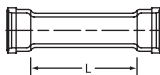

PART NO. SV 900

Service Weight Charlotte Seal Gasket

Size	A	D	F	G	H	Weight
2	3 1/2	2 3/16	2 1/8	3 1/8	1 31/32	0.3
3	4 1/2	3 3/16	3 1/8	4 1/8	2 1/16	0.4
4	5 1/2	4 3/16	4 1/8	5 1/4	2 9/32	0.5
5	6 1/2	5 3/16	5 1/8	6 1/4	2 9/32	0.6
6	7 1/2	6 3/16	6 1/8	7 1/4	2 1/4	0.8
8	9 3/4	8 13/32	8 3/16	9 9/32	3	1.5
10	12 7/16	10 1/2	10 5/16	11 11/16	2 3/4	2.4

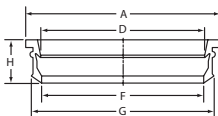

PART NO. SV 950

Service Weight Quik-Tite Gasket

Size	A	D	F	G	H	Weight
2	3 1/2	2 1/16	2	3 1/4	1 3/32	0.3
3	4 7/8	3 1/16	3 1/16	4 3/8	1 3/4	0.4
4	5 3/4	4	4	5 3/16	1 3/4	0.5
5	6 3/4	5	5	6	2 1/16	0.8
6	8	6 5/16	6 5/16	7 11/32	2 5/32	0.8
8	10	8 3/16	8 3/16	8 1/2	2 1/2	1.5
10	12 1/4	10 1/4	10	11 1/2	2 1/2	2.3
12	14 3/8	12 1/4	12	14	2 7/8	3.0

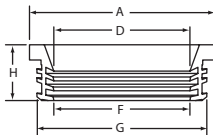

PART NO. SV 5

Quarter Bend

Size	D	X	Weight
2	6	3 ¹ / ₄	5.1
3	7	4	7.7
4	8	4 ¹ / ₂	13.1
5	8 ¹ / ₂	5	16.2
6	9	5 ¹ / ₂	21.7
8	11 ¹ / ₂	6 ⁵ / ₈	36.5
10	12 ¹ / ₂	7 ⁵ / ₈	57.3
12	15	8 ³ / ₄	82.8
15	(HX)	(HX)	(HX)

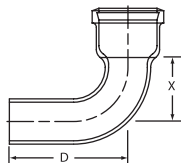

PART NO. SV 7

Sixth Bend

Size	D	X	Weight
2	4 ³ / ₄	2	4.3
3	5 ¹ / ₂	2 ¹ / ₂	6.9
4	6 ⁵ / ₁₆	2 ¹³ / ₁₆	10.8
5	6 ⁵ / ₈	3 ¹ / ₈	14.0
6	6 ⁷ / ₈	3 ³ / ₈	16.4
8	9	4 ¹ / ₈	32.5

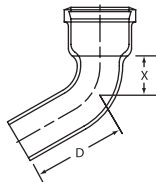

(HX) Please see Extra Heavy dimensions

PART NO. SV 8

Eighth Bend

Size	D	X	Weight
2	4 ¹ / ₄	1 ¹ / ₂	4.2
3	4 ¹⁵ / ₁₆	1 ¹⁵ / ₁₆	6.5
4	5 ¹¹ / ₁₆	2 ³ / ₁₆	10.7
5	5 ⁷ / ₈	2 ³ / ₈	13.1
6	6 ¹ / ₁₆	2 ⁹ / ₁₆	16.6
8	8	3 ¹ / ₈	32.3
10	8 ³ / ₈	3 ¹ / ₂	44.1
12	10 ⁵ / ₁₆	4 ¹ / ₁₆	65.4
15	(XH)	(XH)	(XH)

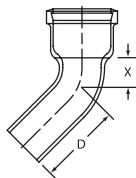

PART NO. SV 9

Sixteenth Bend

Size	D	X	Weight
2	3 ⁵ / ₈	7 ⁷ / ₈	3.4
3	4 ³ / ₁₆	1 ³ / ₁₆	6.0
4	4 ¹³ / ₁₆	1 ⁵ / ₁₆	8.8
5	4 ⁷ / ₈	1 ³ / ₈	11.6
6	5	1 ¹ / ₂	13.8
8	6 ¹¹ / ₁₆	1 ¹³ / ₁₆	24.6
10	6 ⁷ / ₈	2	37.1
12	8 ⁵ / ₈	2 ³ / ₈	57.7
15	(XH)	(XH)	(XH)

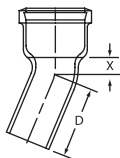

(HX) Please see Extra Heavy dimensions

PART NO. SV 10

Quarter Bend with Low Heel Inlet

Size	D	X	X'	Weight
3 x 2	7	4	9	9.8
4 x 2	8	4½	10½	13.0

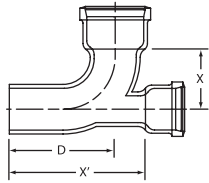

PART NO. SV 12

Quarter Bend with Side Opening

Size	D	X	Weight
4w2LH	8	3½	16.2
4w2RH	8	3½	16.5

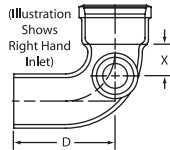

PART NO. SV 15

Double Quarter Bend

Size	D	X	Weight
4	8	4½	15.0

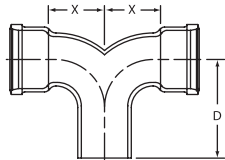

PART NO. SV 18

Reducing Quarter Bend

Size	D	X	Weight
3 x 2	7	3 ³ / ₈	7.0
4 x 2	7 ¹ / ₂	4 ¹ / ₂	11.7
4 x 3	8 ¹ / ₈	4 ³ / ₈	9.1

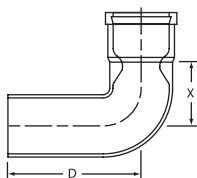

PART NO. SV 23

Single Hub Return Bend

Size	D	X	J	Weight
3	5 ⁵ / ₈	5	5 ⁷ / ₈	9.4
4	7 ¹ / ₂	6 ¹¹ / ₃₂	7 ³ / ₁₆	16.4

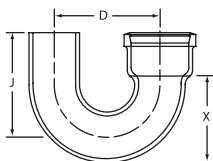

PART NO. SV 25

Long Quarter Bend

Size	D	X	Weight
2 x 12	12	3 ¹ / ₄	6.9
3 x 12	12	4	10.3
4 x 12	12	4 ¹ / ₂	15.4
4 x 16	16	4 ¹ / ₂	20.4
4 x 18	18	4 ¹ / ₂	21.4
4 x 24	24	4 ¹ / ₂	27.9

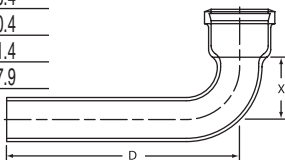

PART NO. SV 26

Long Eighth Bend

Size	D	X	Weight
2 x 12	12	1½	6.2
3 x 12	12	1 ¹⁵ / ₁₆	9.9
3 x 18	18	1 ¹⁵ / ₁₆	12.4
4 x 12	12	2 ³ / ₁₆	15.6
4 x 18	18	2 ³ / ₁₆	20.6
6 x 18	18	2 ⁹ / ₁₆	31.0

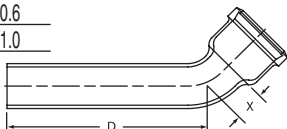

PART NO. SV 29

Short Sweep Bend

Size	D	X	Weight
2	8	5¼	6.2
3	9	6	9.4
4	10	6½	16.6
5	10½	7	20.7
6	11	7½	26.6
8	13½	8 ⁵ / ₈	37.4
10	14½	9 ⁵ / ₈	71.5
12	17	10 ³ / ₄	100.6

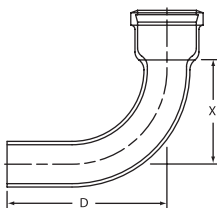

PART NO. SV 30

Long Sweep Bend

Size	D	X	Weight
2	11	8 ¹ / ₄	7.6
3	12	9	12.2
4	13	9 ¹ / ₂	21.2
5	13 ¹ / ₂	10	25.3
6	14	10 ¹ / ₂	29.9
8	16 ¹ / ₂	11 ⁵ / ₈	52.9
10	17 ¹ / ₂	12 ⁵ / ₈	82.6
12	20	13 ³ / ₄	103.5
15	(XH)	(XH)	(XH)

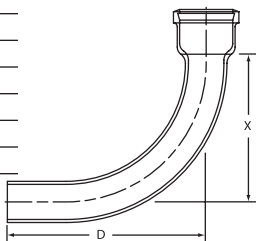

PART NO. SV 31

Reducing Long Sweep Bend

Size	D	X	Weight
3 x 2	12	9	12.0
4 x 3	13	9 ¹ / ₂	17.6

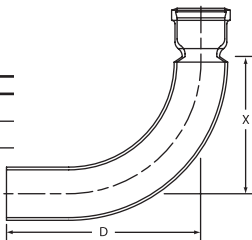

PART NO. SV 32

**Combination Wye & Eighth Bend
(Charlotte Pattern)**

Size	G	H	X	X'	Weight
4	5 ⁷ / ₁₆	4 ³ / ₈	11 ³ / ₈	6 ¹ / ₂	20.3

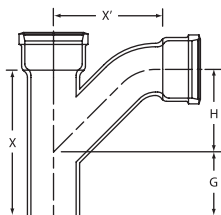

(XH) Please see Extra Heavy dimensions

PART NO. SV 33

**Combination Wye & Eighth Bend
 (Long Turn Pattern)**

Size	G	H	X	X'	Weight
2 x 2	4	3 ³ / ₈	8	4 ⁷ / ₈	8.6
3 x 2	4 ³ / ₁₆	4	9	5 ³ / ₄	11.1
3 x 3	5	5 ¹ / ₁₆	10 ¹ / ₂	7	14.8
4 x 2	3 ¹¹ / ₁₆	4 ¹ / ₂	9	6 ¹ / ₄	15.5
4 x 3	4 ¹ / ₂	5 ⁹ / ₁₆	10 ¹ / ₂	7 ¹ / ₂	19.2
4 x 4	4 ¹ / ₂	7 ¹ / ₂	12	9	24.5
5 x 2	3 ³ / ₈	5	9	6 ³ / ₄	14.6
5 x 3	4	6 ¹ / ₁₆	10 ¹ / ₂	8	21.3
5 x 4	4 ¹ / ₄	7 ⁵ / ₁₆	12	9 ¹ / ₂	25.9
5 x 5	5 ¹ / ₂	8 ⁵ / ₈	13 ¹ / ₂	11	33.6
6 x 2	2 ¹¹ / ₁₆	5 ¹ / ₂	9	7 ¹ / ₄	19.6
6 x 3	3 ¹ / ₈	6 ⁹ / ₁₆	10 ¹ / ₄	8 ¹ / ₂	24.7
6 x 4	4 ¹ / ₄	7 ¹³ / ₁₆	12	10	31.7
6 x 5	5 ¹ / ₁₆	9 ¹ / ₈	13 ¹ / ₂	11 ¹ / ₂	34.3
6 x 6	5 ³ / ₄	10 ⁵ / ₁₆	15	12 ⁷ / ₈	44.2
8 x 2	3 ¹ / ₈	6 ¹ / ₂	10 ¹ / ₂	8 ¹ / ₄	34.0
8 x 4	4 ³ / ₄	8 ¹³ / ₁₆	13 ¹ / ₂	11	40.1
8 x 5	5 ¹ / ₂	10 ¹ / ₈	15	12 ¹ / ₂	49.6
8 x 6	6 ⁵ / ₁₆	11 ⁵ / ₁₆	16 ¹ / ₂	13 ⁷ / ₈	55.7
8 x 8	7 ¹ / ₁₆	13 ⁷ / ₈	19 ¹ / ₂	17	85.6

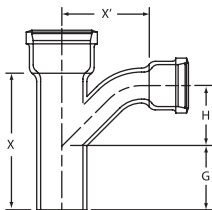

PART NO. SV 35

**Double Combination Wye & Eighth Bend
 (Charlotte Pattern)**

Size	G	H	X	X'	Weight
4	5 ⁷ / ₁₆	4 ³ / ₈	11 ³ / ₈	6 ¹ / ₂	26.0

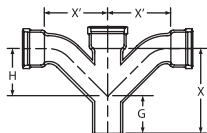

PART NO. SV 35F

**Double Combination Wye & Eighth Bend
(Long Turn Pattern)**

Size	G	H	X	X'	Weight
2 X 2	4	3 ³ / ₈	8	4 ⁷ / ₈	12.0
3 X 2	4 ³ / ₁₆	4	9	5 ³ / ₄	14.6
3 X 3	5	5 ¹ / ₁₆	10 ¹ / ₂	7	22.0
4 X 2	3 ¹¹ / ₁₆	4 ¹ / ₂	9	6 ¹ / ₄	19.7
4 X 3	4 ¹ / ₂	5 ⁹ / ₁₆	10 ¹ / ₂	7 ¹ / ₂	26.5
4 X 4	5 ¹ / ₄	6 ¹³ / ₁₆	12	9	36.2
5 X 4	4 ¹ / ₄	7 ⁵ / ₁₆	12	9 ¹ / ₂	30.9
6 X 4	4 ¹ / ₄	7 ¹³ / ₁₆	12	10	41.0
6 X 6	5 ³ / ₄	10 ⁵ / ₁₆	15	12 ⁷ / ₈	69.6

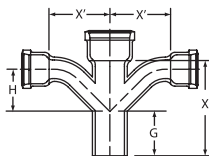

PART NO. SV 35F

**Double Combination Wye & Eighth Bend
with 2" Cup Hub Inlet**

Size	G	G'	H	X	X'	Weight
4	4 ¹ / ₄	10	6 ¹³ / ₁₆	12	9	41.7

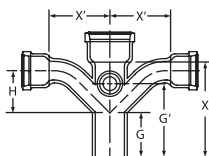

PART NO. SV 39A

**Combination Wye & Eighth Bend
with Side Inlet**

Size	G'	H	X	X'	Weight
4w/2RH	10	12 ¹ / ₁₆	12	9	27.3
4w/2LH	10	12 ¹ / ₁₆	12	9	28.3

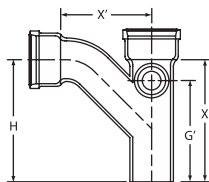

PART NO. SV 41

**Combination Wye & Eighth Bend
with Cleanout on Main**

Size	IPS Tap	G	X	X'	Weight
4	3 ¹ / ₂	9	12 ³ / ₁₆	12 ¹ / ₄	18.9

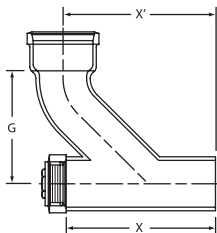

S
E
R
V
I
C
E

PART NO. SV 42

Straight Tee

Size	G	X	X'	Weight
2 x 2	6 $\frac{1}{4}$	8	1 $\frac{3}{4}$	7.0
3 x 2	7	9	2 $\frac{1}{2}$	9.0
3 x 3	7 $\frac{1}{2}$	10	2 $\frac{1}{2}$	12.0
4 x 2	7	9	3	12.7
4 x 3	7 $\frac{1}{2}$	10	3	14.0
4 x 4	8	11	3	16.6
5 x 5	8 $\frac{1}{2}$	12	3 $\frac{1}{2}$	19.0
6 x 4	8	11	4	19.9
6 x 6	9	13	4	24.0
8 x 4	9 $\frac{5}{8}$	12 $\frac{7}{8}$	5 $\frac{1}{4}$	37.0

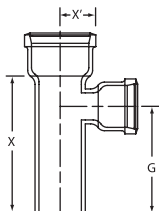

PART NO. SV 43

Sanitary Tee

Size	G	X	X'	Weight
2 x 2	6 ¹ / ₄	8	2 ³ / ₄	7.9
3 x 2	7	9	4	10.9
3 x 3	7 ¹ / ₂	10	4	11.9
4 x 2	7	9	4 ¹ / ₂	14.2
4 x 3	7 ¹ / ₂	10	4 ¹ / ₂	16.9
4 x 4	8	11	4 ¹ / ₂	18.6
5 x 4	8	11	5	17.9
5 x 5	8 ¹ / ₂	12	5	22.3
6 x 2	7	9	5 ¹ / ₂	15.0
6 x 3	7 ¹ / ₂	10	5 ¹ / ₂	21.4
6 x 4	8	11	5 ¹ / ₂	22.8
6 x 6	9	13	5 ¹ / ₂	29.8
8 x 4	9 ³ / ₄	13	6 ¹ / ₂	35.7
8 x 6	10 ³ / ₄	15	6 ¹ / ₂	43.0
8 x 8	11 ³ / ₄	17	6 ⁵ / ₈	50.8
10 x 4	9 ³ / ₄	13	7 ¹ / ₂	52.0
10 x 6	10 ³ / ₄	15	7 ¹ / ₂	57.7
10 x 8	11 ³ / ₄	17	7 ⁵ / ₈	68.0
10 x 10	12 ³ / ₄	19	7 ⁵ / ₈	75.9
12 x 6	12	16 ¹ / ₂	8 ¹ / ₂	79.0
12 x 8	13	18 ¹ / ₂	8 ⁵ / ₈	104.0
12 x 10	14	20 ¹ / ₂	8 ⁵ / ₈	123.0
12 x 12	15	22 ¹ / ₂	8 ³ / ₄	113.0
15 x 6	12	16 ¹ / ₂	10	145.0
15 x 8	13	18 ¹ / ₂	10 ¹ / ₈	173.0
15 x 12	15	22 ¹ / ₂	10 ¹ / ₄	204.0
15 x 15	(XH)	(XH)	(XH)	(XH)

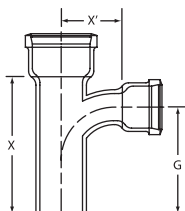

(XH) Please see Extra Heavy dimensions

PART NO. SV 44

Wye

Size	G	X	X'	Weight
2 x 2	4	8	4	8.3
3 x 2	4 ³ / ₁₆	9	5	10.9
3 x 3	5	10 ¹ / ₂	5 ¹ / ₂	12.2
4 x 2	3 ⁵ / ₈	9	5 ³ / ₄	14.4
4 x 3	4 ⁷ / ₁₆	10 ¹ / ₂	6 ¹ / ₄	16.8
4 x 4	5 ¹ / ₄	12	6 ³ / ₄	20.3
5 x 2	3 ¹ / ₈	9	6 ¹ / ₂	15.3
5 x 3	3 ⁷ / ₈	10 ¹ / ₂	7	19.8
5 x 4	4 ¹¹ / ₁₆	12	7 ¹ / ₂	23.0
5 x 5	5 ¹ / ₂	13 ¹ / ₂	8	27.0
6 x 2	2 ⁹ / ₁₆	9	7 ¹ / ₄	19.7
6 x 3	3 ³ / ₈	10 ¹ / ₂	7 ³ / ₄	23.7
6 x 4	4 ³ / ₁₆	12	8 ¹ / ₄	26.7
6 x 5	4 ¹⁵ / ₁₆	13 ¹ / ₂	8 ³ / ₄	29.5
6 x 6	5 ³ / ₄	15	9 ¹ / ₄	36.5
8 x 2	3 ¹ / ₈	10 ¹ / ₂	8 ¹ / ₂	31.0
8 x 3	3 ¹⁵ / ₁₆	12	9	33.2
8 x 4	4 ³ / ₄	13 ¹ / ₂	9 ¹ / ₂	38.3
8 x 5	5 ¹ / ₂	15	10	41.2
8 x 6	6 ⁵ / ₁₆	16 ¹ / ₂	10 ¹ / ₂	45.4
8 x 8	7 ¹ / ₁₆	19 ¹ / ₂	11 ¹³ / ₁₆	58.4
10 x 3	2 ³ / ₄	12	10 ³ / ₄	54.0
10 x 4	3 ⁹ / ₁₆	13 ¹ / ₂	11 ¹ / ₈	55.4
10 x 5	4 ⁵ / ₁₆	15	11 ⁵ / ₈	60.6
10 x 6	5 ¹ / ₈	16 ¹ / ₂	12 ¹ / ₈	64.1
10 x 8	6 ¹ / ₂	19 ¹ / ₂	13 ⁷ / ₁₆	86.9
10 x 10	8	22 ¹ / ₂	14 ¹ / ₂	111.1
12 x 4	4 ¹ / ₈	15	12 ⁷ / ₁₆	69.7
12 x 5	4 ⁷ / ₈	16 ¹ / ₂	12 ¹⁵ / ₁₆	78.0
12 x 6	5 ¹ / ₁₆	18	13 ⁷ / ₁₆	87.7
12 x 8	7 ¹ / ₁₆	21	14 ³ / ₄	100.6
12 x 10	8 ⁹ / ₁₆	24	15 ³ / ₁₆	131.0
12 x 12	10 ¹ / ₈	27	16 ⁷ / ₈	175.2
15 x 4	6 ³ / ₈	15	15	138.5
15 x 6	4	18	15 ³ / ₄	153.6
15 x 8	5 ³ / ₈	21	17 ¹ / ₁₆	187.1
15 x 10	6 ⁷ / ₈	24	18 ¹ / ₈	225.0
15 x 12	8 ⁷ / ₁₆	27	19 ³ / ₁₆	260.0
15 x 15	(XH)	(XH)	(XH)	(XH)

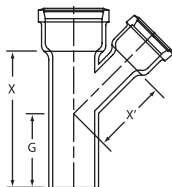

(XH) Please see Extra Heavy dimensions

PART NO. SV 50

**Sanitary Tee
with Left Hand Side Tap**

Size	G	G'	X	X'	Weight
4w/2	8	9	11	4 1/2	16.3

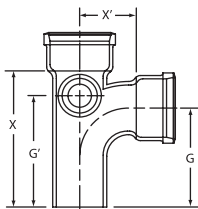

PART NO. SV 50A

**Sanitary Tee
with Right Hand Side Tap**

Size	G	G'	X	X'	Weight
4w/2	8	9	11	4 1/2	16.5

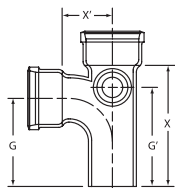

PART NO. SV 50B

**Sanitary Tee
with Right and Left Hand Side Taps**

Size	G	G'	X	X'	Weight
4w/2	8	9	11	4 1/2	16.3

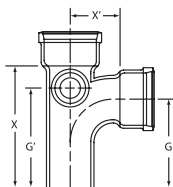

PART NO. SV 56

Sanitary Tee with Left Hand Side Inlet

Size	G	G'	X	X'	Weight
4w/2	8	9	11	4 1/2	20.2

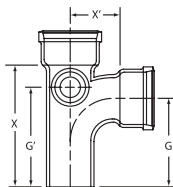

PART NO. SV 56B

**Sanitary Tee
with Right Hand Side Inlet**

Size	G	G'	X	X'	Weight
4w/2	8	9	11	4 1/2	20.0

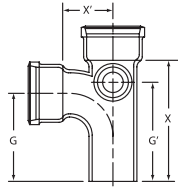

PART NO. SV 56C

**Sanitary Tee
with Right and Left Hand Side Inlets**

Size	G	G'	X	X'	Weight
4w/2	8	9	11	4 1/2	23.1

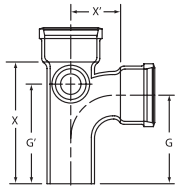

PART NO. SV 57

Wye with Left Hand Side Inlet

Size	G	G'	X	X'	Weight
4w/2	5 1/4	10	12	6 3/4	23.8

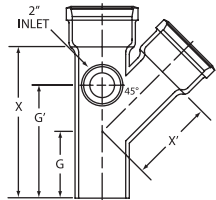

PART NO. SV 57A

Wye with Right Hand Side Inlet

Size	G	G'	X	X'	Weight
4w/2	5 1/4	10	12	6 3/4	23.8

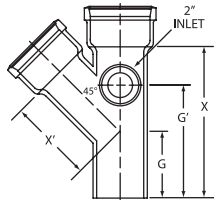

PART NO. SV 71A

Single Two-Way Cleanout

Size	X	E'	G	Weight
4	22 ⁷ / ₁₆	9 ³ / ₈	12 ³ / ₄	33.5

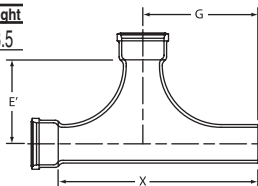

PART NO. SV 71B

Short Special Two-Way Cleanout

Size	G	X	X'	Weight
4	8	12	4	16.0

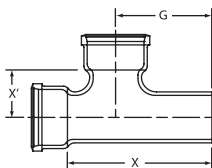

PART NO. SV 72

Double Two-Way Cleanout

Size	G	J	X	X'	Weight
4	6 ¹ / ₂	6 ⁷ / ₁₆	13 ⁵ / ₈	7 ¹ / ₂	31.2
6 x 4 x 4	6 ¹ / ₂	6 ⁷ / ₁₆	13 ⁵ / ₈	8 ¹ / ₄	39.1

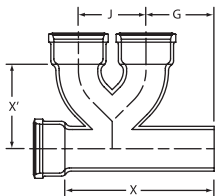

PART NO. SV 76

Sanitary Tee with Cleanout on Main

Size	IPS	G	X	X'	Weight
	Tap				
4	3 ¹ / ₂	8	12 ¹ / ₈	4 ¹ / ₂	16.7

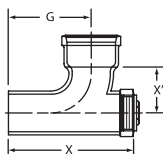

PART NO. SV 79

Washington Test Tee[‡]

Size	IPS		E'	G	X	Weight
	Tap					
2	2		1 ³ / ₄	7	9	7.3
3	4		2 ⁷ / ₈	7 ¹ / ₈	10 ³ / ₄	13.1
4	4		3 ¹ / ₄	7 ¹ / ₄	10 ⁵ / ₈	16.8
5	5		3 ⁵ / ₈	7	11	22.5
6	6		4	8 ³ / ₄	13	26.9
8	8		5	11	16 ³ / ₈	41.6
10	10		7 ¹ / ₂	11	17 ⁵ / ₈	68.7

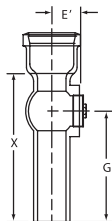

PART NO. SV 80

Cleanout Tee with Brass Plug

Size	IPS		E'	G	X	Weight
	Tap					
2	1 ¹ / ₂		2	6 ¹ / ₄	8	6.2
3	2		2 ¹ / ₂	7	9	9.3
4	3		3	8	11	14.6
5	4		3 ¹ / ₂	8 ¹ / ₂	12	18.7
6	4		4 ¹ / ₄	9	13	25.3
12	8		8	13	18 ¹ / ₂	92.2

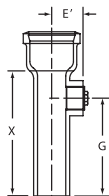

PART NO. SV 81

Miami Test Tee, Less Plug

and PART NO. SV 81S

Miami Test Tee with Southern
Raised-Head Brass Plug Installed

Size	IPS		E'	G	X	Weight
	Tap					
2	2		2 ¹ / ₃₂	6 ¹ / ₂	9	7.0
3	3		2 ¹ / ₂	6 ⁵ / ₈	9 ⁵ / ₈	10.0
4	4		3	7 ¹ / ₄	11	15.5
6	6		4	9	13 ¹ / ₄	22.8

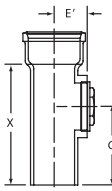

[‡] This fitting can be ordered without or with a Southern Raised Head Brass Plug installed (2" through 8" available with plug).

PART NO. SV 82

Test Tee with Internal Tap

Size	E'	G	X	Weight
4	2 ¹⁵ / ₁₆	7 ⁷ / ₈	12	15.9

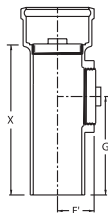

PART NO. SV 83

Straight Tapped Tee

Size	E'	G	X	Weight
2 x 1 ¹ / ₂	2	6 ¹ / ₄	8	5.5
2 x 2	2	6 ¹ / ₄	8	6.0
3 x 1 ¹ / ₂	2 ¹ / ₂	7	9	7.4
3 x 2	2 ¹ / ₂	7	9	8.6
4 x 2	3	7	9	12.3
4 x 3	4	8	11	14.0
4 x 4	3	7 ¹ / ₄	11	15.0
5 x 2	3 ¹ / ₂	7	9	13.5
5 x 4	3 ¹ / ₂	8 ¹ / ₂	12	17.9
6 x 4	4 ¹ / ₄	9	13	24.4

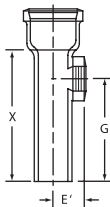

PART NO. SV 84

Sanitary Tapped Tee

Size	E'	G	X	Weight
2 x 1 ¹ / ₂	2 ¹³ / ₁₆	6 ¹ / ₄	8	6.0
2 x 2	3 ¹ / ₁₆	6 ¹ / ₄	8	5.8
3 x 1 ¹ / ₂	3 ⁵ / ₁₆	7	9	8.0
3 x 2	3 ⁹ / ₁₆	7	9	8.1
4 x 1 ¹ / ₂	3 ¹³ / ₁₆	7	9	10.3
4 x 2	4 ¹ / ₁₆	7	9	11.7
4 x 3	4 ¹ / ₁₆	8	11	13.6

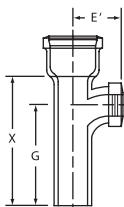

PART NO. SV 85

Tapped Wye

Size	G	X	X'	Weight
3 x 2	5	10 1/2	6 5/8	10.3
4 x 1 1/2	4 1/2	9	6 1/2	11.0
4 x 2	4 1/4	9	6	12.7

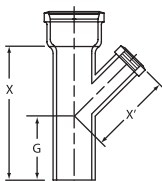

PART NO. SV 89

Long Sanitary Tapped Tee

Size	E'	G	X	Weight
2 x 2 x 18	3 1/16	16	18	8.8

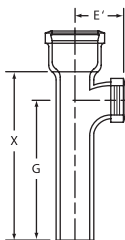

PART NO. SV 91

Sanitary Tapped Cross

Size	E'	G	X	Weight
2 x 1 1/2	2 13/16	6 1/4	8	11.3
2 x 2	3 1/16	6 1/4	8	6.7
3 x 2	3 9/16	7	9	9.0
4 x 2	4 1/16	7	9	11.6

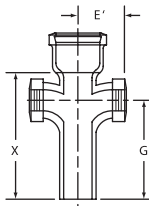

PART NO. SV 92

Tapped Double Wye

Size	G	X	X'	Weight
4 x 2	5 3/4	12	7 7/8	16.9

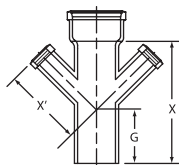

PART NO. SV 93

Tapped Cross

Size	E'	G	X	Weight
3 x 2	2 1/2	7	9	9.4
4 x 2	3	7	9	13.1

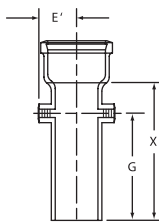

PART NO. SV 108

Straight Cross

Size	G	X	X'	Weight
4 x 2	7	9	3	16.0
4	8	11	3	17.0

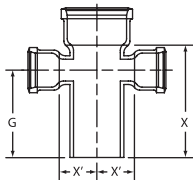

PART NO. SV 109

Sanitary Cross

Size	G	X	X'	Weight
2	6 1/4	8	2 3/4	10.0
3 x 2	7	9	4	12.5
3	7 1/2	10	4	15.6
4 x 2	7	9	4 1/2	16.0
4 x 3	7 1/2	10	4 1/2	20.0
4	8	11	4 1/2	22.9
5 x 4	8	11	5	23.2
6 x 4	8	11	5 1/2	29.0
6	9	13	5 1/2	34.9
8	11 3/4	17	6 5/8	105.0

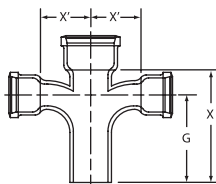

PART NO. SV 110

Double Wye

Size	G	X	X'	Weight
2	4	8	4	9.7
3 x 2	4 ³ / ₁₆	9	5	12.8
3	5	10 ¹ / ₂	5 ¹ / ₂	17.5
4 x 2	3 ⁵ / ₈	9	5 ³ / ₄	16.2
4 x 3	4 ⁷ / ₁₆	10 ¹ / ₂	6 ¹ / ₄	19.8
4	5 ¹ / ₄	12	6 ³ / ₄	27.2
5	5 ¹ / ₂	13 ¹ / ₂	8	27.0
6 x 3	3 ³ / ₈	10 ¹ / ₂	7 ³ / ₄	24.6
6 x 4	4 ³ / ₁₆	12	8 ¹ / ₄	31.8
6	5 ³ / ₄	15	9 ¹ / ₄	44.0
8 x 4	4 ³ / ₄	13 ¹ / ₂	9 ¹ / ₂	44.5
8 x 6	6 ⁵ / ₁₆	16 ¹ / ₂	10 ¹ / ₂	57.3
8	7 ¹ / ₁₆	19 ¹ / ₂	11 ¹³ / ₁₆	90.0
10 x 6	5 ¹ / ₈	16 ¹ / ₂	12 ¹ / ₈	73.7
10 x 8	6 ¹ / ₂	19 ¹ / ₂	13 ⁷ / ₁₆	99.0
10	8	22 ¹ / ₂	14 ¹ / ₂	172.0
12 x 6	5 ¹ / ₁₆	18	13 ⁷ / ₁₆	112.0
12 x 8	7 ¹ / ₁₆	21	14 ³ / ₄	135.0
12	10 ¹ / ₈	27	16 ⁷ / ₈	216.1
15	(XH)	(XH)	(XH)	(XH)

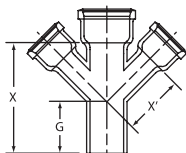

PART NO. SV 114

Sanitary Cross with 2" Side Inlet

Size	G	G'	X	X'	Weight
4	8	9	11	4 ¹ / ₂	27.0

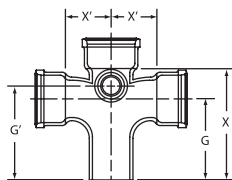

(XH) Please see Extra Heavy dimensions

PART NO. SV 115

Double Wye with 2" Side Opening

Size	G	H	X	X'	Weight
4 x 4	5 1/4	10	12	6 3/4	31.8

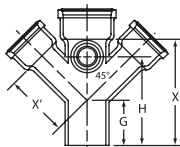

PART NO. SV 134

Vent Branch

Size	X	X'	J	G	G'	Weight
4	11	6	6 1/2	4	8	19.6

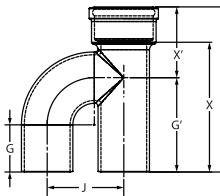

PART NO. SV 135

"H" Branch

Size	X	X'	J	G	Weight
4 x 3	12 3/16	7 9/16	6	4 1/2	17.0
4	13 15/16	8 11/16	6 1/2	5 1/4	19.6

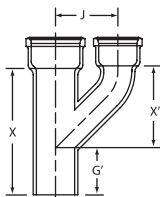

PART NO. SV 137

Bar Grate with Legs

Size	G	X	Weight
4	3	4 3/4	2.0

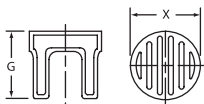

PART NO. SV 141

45° Offset

Size/Offset	X	G'	J	Weight
4 x 4	11	4	4	11.6
4 x 6	13	4	6	15.0
4 x 8	15	4	8	15.6

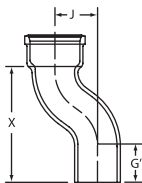

PART NO. SV 143

Reducer

Size	X	Weight
3 x 2	4 ³ / ₄	4.6
4 x 2	5	6.0
4 x 3	5	7.0
5 x 2	5	6.6
5 x 3	5	6.8
5 x 4	5	9.0
6 x 2	5	8.2
6 x 3	5	9.9
6 x 4	5	10.4
6 x 5	5	10.9
8 x 3	6	14.3
8 x 4	6	16.6
8 x 5	6	16.4
8 x 6	6	16.8
10 x 4	6	20.0
10 x 5	6	23.9
10 x 6	6	24.0
10 x 8	6	26.5
12 x 4	6 ¹ / ₂	32.2
12 x 6	6 ¹ / ₂	34.4
12 x 8	6 ¹ / ₂	37.2
12 x 10	6 ¹ / ₂	38.4
15 x 6	6 ¹ / ₂	52.3
15 x 8	6 ¹ / ₂	55.0
15 x 10	6 ¹ / ₂	55.7
15 x 12	6 ¹ / ₂	64.9

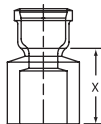

PART NO. SV 144

Reducer Increaser

Size	X	Weight
2 x 4	9	9.4
3 x 4	9	8.8
4 x 5	9	11.3
4 x 6	9	15.2
4 x 8	12	24.5
5 x 6	9	12.8
6 x 8	12	24.0
8 x 10	12	44.0

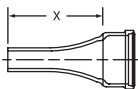

PART NO. SV 147

Long Plain Increaser

Size	X	Weight
3 x 4 x 24	24	13.6
4 x 5 x 30	30	27.4

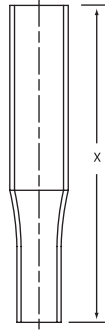

PART NO. SV 148

Long Tapped Increaser

Size	X	Weight
2 x 4 x 30	30	22.8

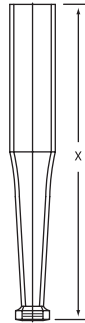

PART NO. SV 151

Tapped Spigot

Size	A	Weight
4 x 2	4 1/4	4.7

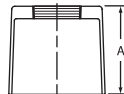

SERVICE

PART NO. SV 153

Double Hub Fitting

Size	X	Weight
2	1¼	4.2
3	1¼	7.0
4	1½	9.1
6	1½	13.1
8	1½	22.1
10	1½	36.3
12	1½	46.3
15	(XH)	(XH)

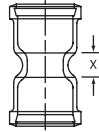

PART NO. SV 155

Pipe Plug

Size	X	Weight
2	3½	1.3
3	3¾	2.5
4	4	4.1
5	4	6.0
6	4	8.0
8	4½	12.4
10	4½	17.7
12	5¼	23.3
15	(XH)	(XH)

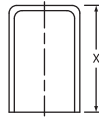

PART NO. SV 159

Vent Cap with Set Screw

Size	Weight
4	2.6



PART NO. SV 169

"P" Trap

Size	J	X	Weight
2	4	9½	7.1
3	5½	12	13.1
4	6½	14	23.2
5	7½	15½	30.4
6	8½	17	42.0
8	10½	22¼	86.2

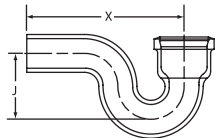

(XH) Please see Extra Heavy dimensions

PART NO. SV 170

Running Trap

Size	X	C	J	Weight
4	17½	6	6½	19.3
6	21½	8	8½	48.0

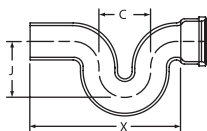

PART NO. SV 174

Running Trap with Single Hub Vent

Size	Vent Size	C	J	X	X'	Weight
3	3	5	5½	15	2½	15.3
4	4	6	6½	17½	3	28.3
5	4	7	7½	19½	3½	39.7
6	4	8	8½	21½	4	45.9
8	4	10	11	27 ⁵ / ₈	5¼	95.9
8	6	10	11	27 ⁵ / ₈	5¼	110.0

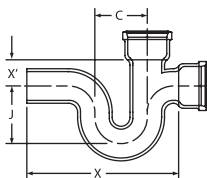

PART NO. SV 175

Running Trap with Double Hub Vent

Size	Vent Size	C	J	X	X'	Weight
3	3	5	5½	15	2½	23.0
4	4	6	6½	17½	3	36.3
5	4	7	7½	19½	3½	42.5
6	4	8	8½	21½	4	57.3
6	6	8	8½	21½	4	61.5
8	4	10	11	27 ⁵ / ₈	5¼	98.8
8	6	10	11	27 ⁵ / ₈	5¼	99.7
10	8	12	13	31 ⁵ / ₈	6¼	187.0
12	10	15	15	38¾	7¼	287.6
15	12	18½	18½	45	9	460.0

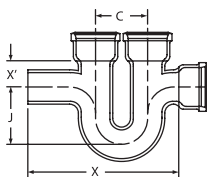

S
E
R
V
I
C
E

PART NO. SV 180

Deep Seal "P" Trap

Size	X	J	Weight
2	9½	6	8.1
3	12	7	14.3
4	14	8	29.0
6	17	9½	40.4

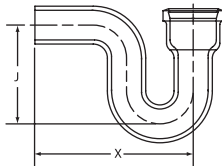

PART NO. SV 184^(T)

Improved Running Trap with Double Cleanout and Tee Branch

Vent Size	Size	E	G	X	X'	Weight
4	3	5¼	6¼	20½	5½	34.3
4	4	5¾	6¼	20½	5½	33.7

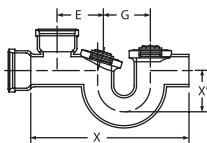

PART NO. SV 188^(T)

"P" Trap with Cleanout Right Side

Size	X	J	B	D	Weight
4	14	6½	11	5½	20.0

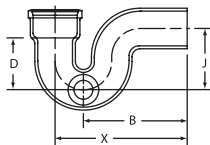

PART NO. SV 188A^(T)

"P" Trap with Cleanout Left Side

Size	X	J	B	D	Weight
4	14	6½	11	5½	20.0

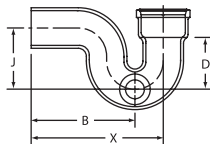

PART NO. SV 198

"P" Trap with ½" Heel Tap

Size	X	J	A	Weight
2	9½	4	4	6.8
3	12	5½	4¾	13.0
4	14	6½	4¾	23.1

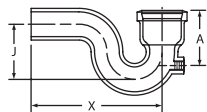

^(T) Note: 3½" IPS tap

PART NO. SV 200

Closet Bend, Plain - Less Collar

Size	A	B	Weight
3 x 4	6	12	11.3
3 x 4	6	15	12.0
3 x 4	6	16	12.0
3 x 4	6	18	13.0
3 x 4	8	18	14.0
3 x 4	10	12	13.0
3 x 4	10	15	13.0
3 x 4	10	16	17.5
3 x 4	10	18	16.0
3 x 4	12	12	15.9
3 x 4	16	16	20.6
3 x 4	18	18	22.7
3	16	16	16.7
4	4	12	12.3
4	4	14	11.0
4	4	16	14.3
4	4	18	17.1
4	6	12	12.5
4	6	15	15.0
4	6	16	16.9
4	6	18	14.0
4	8	16	18.4
4	8	18	19.8
4	10	12	15.3
4	10	15	18.0
4	10	16	19.6
4	10	18	19.0
4	12	12	14.0
4	12	14	14.0
4	12	16	20.8
4	12	18	19.0
4	14	16	22.6
4	14	18	24.0
4	16	16	23.8
4	16	18	24.7
4	18	18	27.4

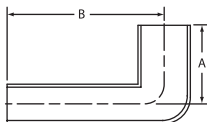

PART NO. SV 206

**Tapped Closet Bend with
Southern Code Brass Plug**

Size	A	B	Weight
3 1/2 x 4 x 4 x 18	18	4	17.4

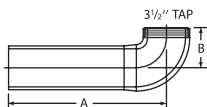

PART NO. SV 208

Hub-End Closet Bend, Low Hub

Size	A	B	Weight
4	4 5/8	12	14.2
4	4 5/8	14	15.4
4	4 5/8	16	17.5
4	4 5/8	18	18.9

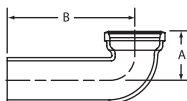

PART NO. SPL 217

Offset Closet Flange (To Offset 1")

Size	A	B	C	D	Weight
4 x 2	2	6	1	5/8	2.5
4 x 2 1/2	2 1/2	7 3/16	1	5/8	3.3
4 x 4 [◇]	4	6 1/4	2	2	4.5

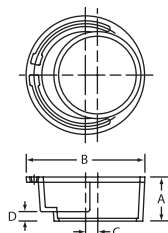

PART NO. SPL 219

**Greensboro
Reducing Closet Flange
(Can be used to connect 4" fixture
with 3" line, or 4" No-Hub)**

Size	A	B	Weight
4 x 3 x 3	3 1/8	7 3/16	3.7

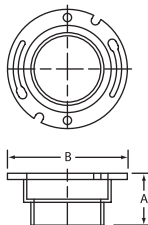

◇ 2" Offset

PART NO. SPL 220*

Clotset Flange, Notched and Slotted

Size	A	B	Weight
4 x 1	1	7 ³ / ₁₆	2.0
4 x 1½	1½	7 ³ / ₁₆	2.6
4 x 2	2	7 ³ / ₁₆	3.0
4 x 2½	2½	7 ³ / ₁₆	3.6
4 x 3	3	7 ³ / ₁₆	4.3
4 x 4	4	7 ³ / ₁₆	4.7
4 x 5	5	7 ³ / ₁₆	4.5
4 x 6	6	7 ³ / ₁₆	5.3

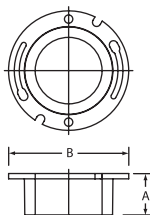

PART NO. SPL 225

Instant Set Clotset Flange

Size	A	Weight
3 x 2†	2	3.5
4 x 2‡	2	5.6
4 x 3§	2	3.0
4 x 4‡	4	4.0

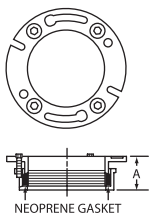

* Caulk type to go over pipe.

† Four-bolt pattern. Test cap configuration not offered.

‡ Three-bolt pattern. Available with or without test cap.

§ Three-bolt reducing pattern, with test cap.

PART NO. SV 228

**Iron Body Cleanout Ferrule, Body Only,
Less Brass Plug**

and PART NO. SV 228S

**Iron Body Cleanout Ferrule with Southern
Raised-Head Brass Plug Installed †**

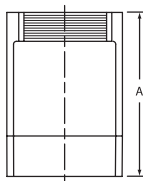

Size	Tap Size	A	Weight
2	1½	3½	1.3
3	2½	3¾	2.0
4	3	4¼	3.6
5	4	4¼	4.5
6	5	4¼	5.2
8	6	4½	11.7
10	6	4½	16.3
12	6	5¼	25.5
15	(XH)	(XH)	(XH)
4 x 3½	3½	4½	4.0
4 x 8	3½	8	8.1
4 x 12	3½	12	9.2

PART NO. SV 253

Sission Insertable Joint

Size	A	B	C	Weight
2	14	6	6	7.0
3	16	8	6¾	11.6
4	14½	7	6	12.9
5	15⅞	9	5⅞	17.0
6	16⅜	8½	6	20.4
8	18	10	6¾	37.0

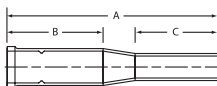
**PART NO. SV 458**

**Vented Closet Tee with 2" Top Vent
and 2" Extended Side Inlet**

**(Right Hand or Left Hand; Designed for use
below the floor; Fitting does not require a baffle)**

Size	A	B	C	D	E	Weight
4x4x2x2x4 RH	11	4½	5³⁄₁₆	4⁹⁄₁₆	4³⁄₁₆	37.0
4x4x2x2x4 LH	11	4½	5³⁄₁₆	4⁹⁄₁₆	4³⁄₁₆	37.8

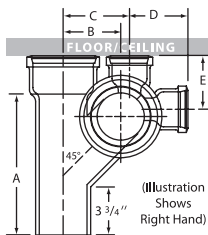

(XH) Please see Extra Heavy dimensions.

† This fitting not available with plug installed in 4 x 3½ and 4 x 8 fitting sizes.

PART NO. SV 459D

**Vented Closet Cross with 2" Top Vent
and 2" Extended Side Inlet**
(Designed for use below the floor;
Fitting does not have a baffle)

Size	A	B	C	Weight
4x4x2x2x4	11	6 ¹ / ₄	4 ³ / ₄	47.0

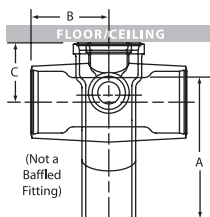

PART NO. SV 460

Vented Closet Tee with 2" Top Vent
(Right Hand or Left Hand; Designed for use
below the floor; Fitting does not require a baffle)

Size	A	B	C	Weight
4x4x2x4RH	11	4 ¹ / ₂	5 ³ / ₁₆	35.0
4x4x2x4LH	11	4 ¹ / ₂	5 ³ / ₁₆	35.0

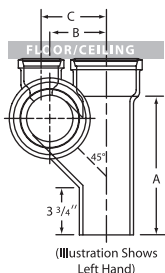

PART NO. SV 463D

**Vented Closet Cross with 2" Top Vent
and 2" Extended Side Inlet**
(Designed for use below the floor;
Fitting does not have a baffle)

Size	A	B	C	Weight
4x4x2	11	6 ¹ / ₄	4 ³ / ₄	43.8

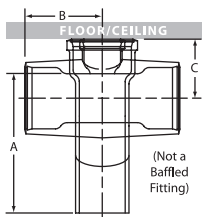

PART NO. SV 566

Tapped Long Sweep Tee

Size	A	B	C	D	Weight
2x2	5 ¹ / ₂	3 ¹ / ₈	4	5 ⁵ / ₈	6.2

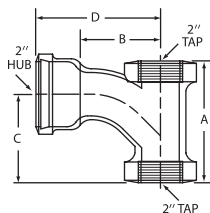

S
E
R
V
I
C
E

PART NO. SV 581

Double Sink Stack-1770
(Designed for use above the floor)

Size	A	B	C	D	E	Weight
3 x 2 x 2	12 ³ / ₄	4 ¹ / ₂	6 ⁵ / ₈	4 ¹ / ₂	5 ³ / ₄	18.0
4 x 2 x 2	12 ¹ / ₂	5	7 ¹ / ₂	4 ¹ / ₂	6 ⁵ / ₈	21.4

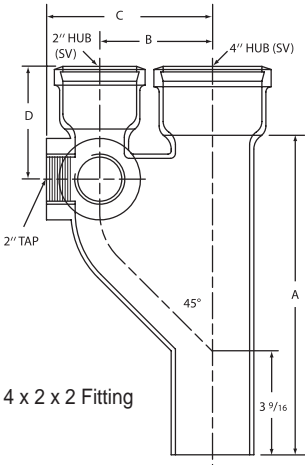
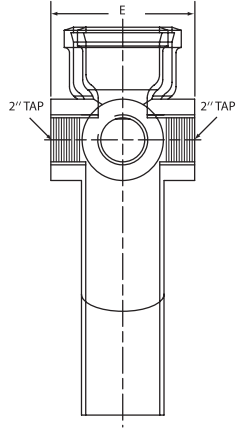
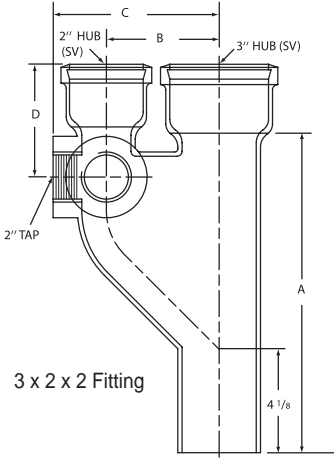

PART NO. SV 581 B

Double Sink Stack with Baffle
(Designed for use above the floor)

Size	A	B	C	D	E	Weight
4 x 2 x 2	12 ¹ / ₂	5	7 ¹ / ₂	4 ¹ / ₂	6 ⁵ / ₈	23.8

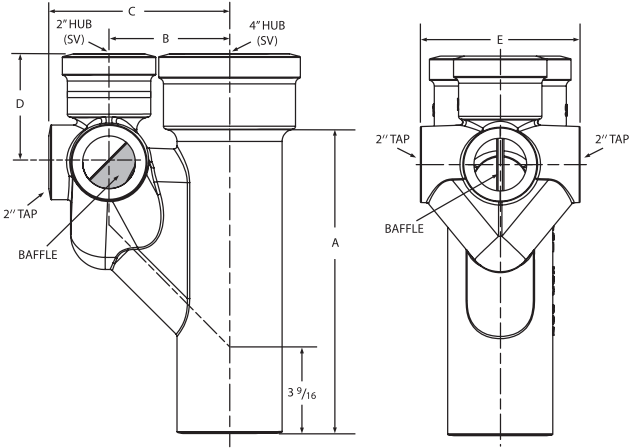

S
E
R
V
I
C
E

PART NO. SV 973R

Right Hand Starter Fitting with 4" Tap and 2" Tapped "A" Side Inlet
(Designed for use above the floor with back-outlet water closets)

Size	Inlet	A	B	C	D	E	F	X	Weight
4	6 1/2	See Chart	6 1/2	4	4 1/16	4	4	25	34.8
4	9 1/2	See Chart	6 1/2	4	4 1/16	4	4	25	34.4

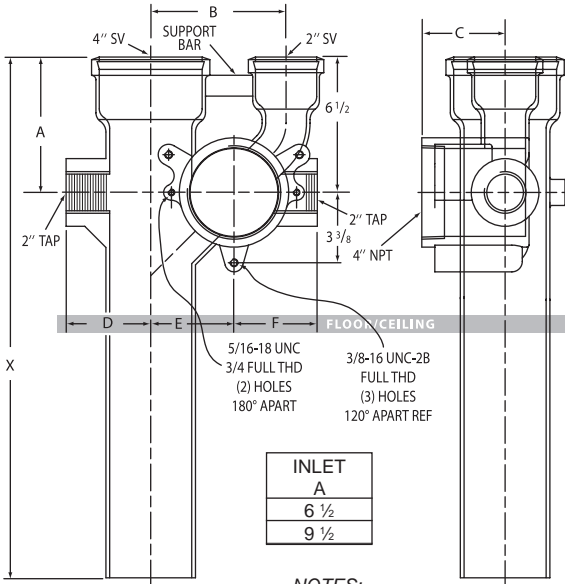

- NOTES:**
1. Single Vertical R.H. Offset Back Outlet Starter Fitting
 2. 4" Stack with 2" Vent & Inlets
 3. Face Plate Package Not Included

PART NO. SV 973L

Left Hand Starter Fitting with 4" Tap and 2" Tapped "A" Side Inlet
(Designed for use above the floor with back-outlet water closets)

Size	Inlet	A	B	C	D	E	F	X	Weight
4	6 1/2	See Chart	6 1/2	4	4	4	4	25	39.2
4	9 1/2	See Chart	6 1/2	4	4	4	4	25	39.0

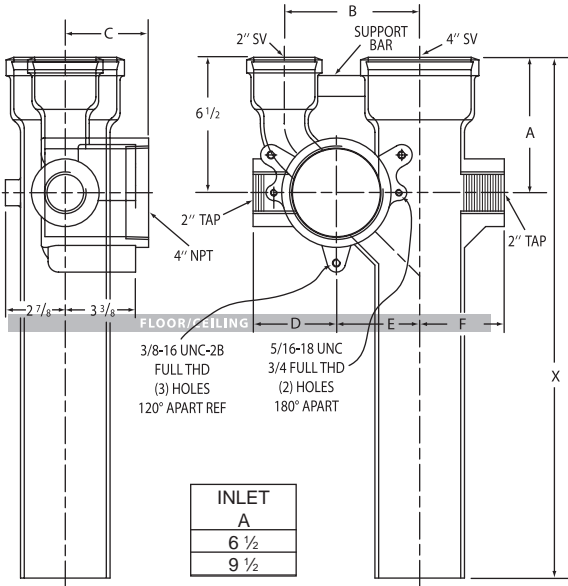

- NOTES:**
1. Single Vertical L.H. Offset Back Outlet Starter Fitting
 2. 4" Stack with 2" Vent & Inlets
 3. Face Plate Package Not Included

PART NO. SV 974R

**Right Hand Starter Fitting with 4" Hub and
2" Tapped "A" Side Inlet**
(Designed for use above or in the floor with back-outlet
or bottom-outlet water closets)

Size	A	B	C	D	E	F	X	Weight
4 with A Inlet	6 1/2	6 1/2	6 1/2	4 1/16	4	4	25	39.2

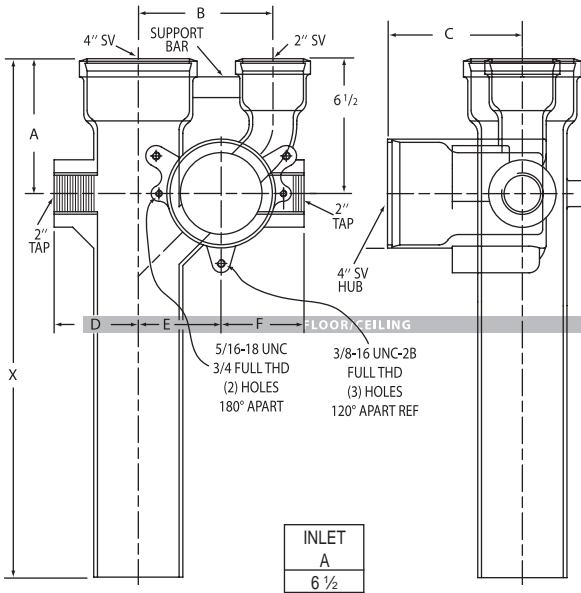

PART NO. SV 974R

**Right Hand Starter Fitting with 4" Hub and
2" Tapped "A" and "B" Side Inlets**
(Designed for use above or in the floor with back-outlet
or bottom-outlet water closets)

Size	A	B	C	D	X	Weight
4 with A & B Inlets	6½	18	6½	6½	25	46.2

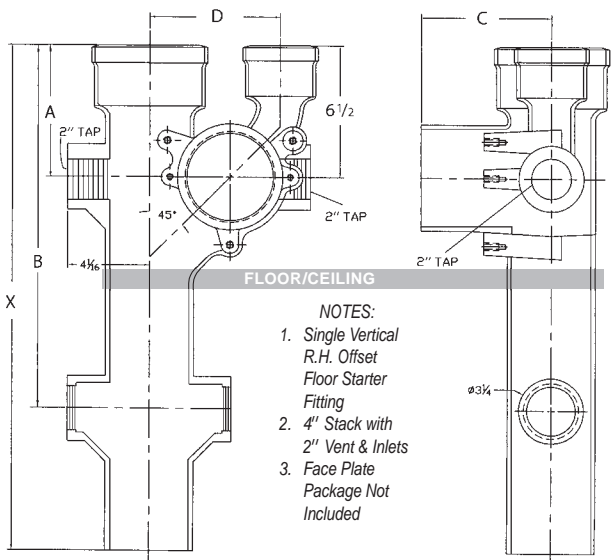

- NOTES:**
1. Single Vertical R.H. Offset Floor Starter Fitting
 2. 4" Stack with 2" Vent & Inlets
 3. Face Plate Package Not Included

INLET	
A	B
6½	18

**S
E
R
V
I
C
E**

PART NO. SV 974L

**Left Hand Starter Fitting with 4" Hub and
2" Tapped "A" Side Inlet**
(Designed for use above or in the floor with back-outlet
or bottom-outlet water closets)

Size	A	B	C	D	E	F	X	Weight
4 with A Inlet	6 1/2	6 1/2	6 1/2	4	4	4 1/16	25	39.7

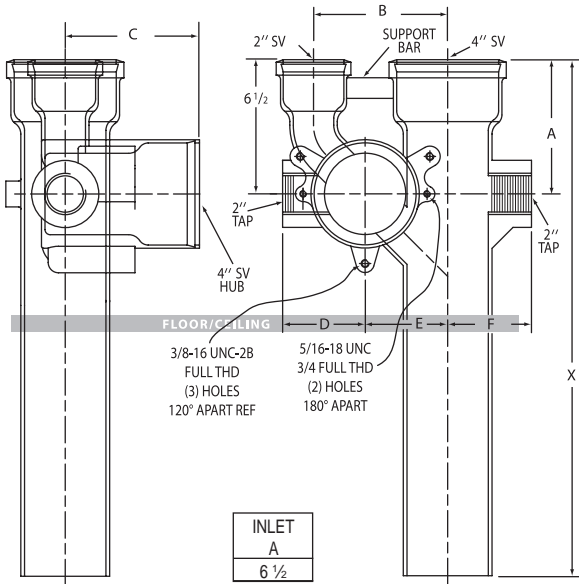

PART NO. SV 974L

**Left Hand Starter Fitting with 4" Hub and
2" Tapped "A" and "B" Side Inlets
(Designed for use above or in the floor with back-outlet
or bottom-outlet water closets)**

Size	A	B	C	D	X	Weight
4 with A & B Inlets	6 1/2	18	6 1/2	6 1/2	25	43.7

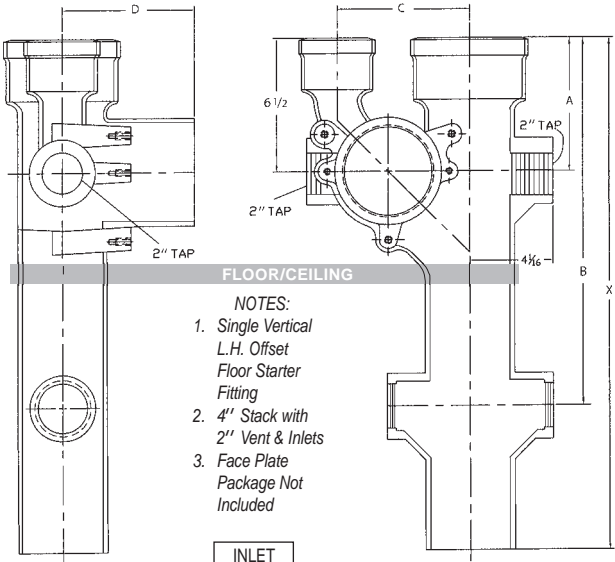

- NOTES:**
1. Single Vertical L.H. Offset Floor Starter Fitting
 2. 4" Stack with 2" Vent & Inlets
 3. Face Plate Package Not Included

INLET	
A	B
6 1/2	18

**S
E
R
V
I
C
E**

PART NO. SV 975

**Double Starter Fitting with 4" Tap and
2" Tapped "A" Side Inlet**
[Designed for use above the floor with back-outlet
water closets; Fitting has a baffle]

Size	A	B	C	D	E	F	X	Weight
4 with A Inlet	9 1/2	6 1/2	4	4	4	4 1/16	25	42.5

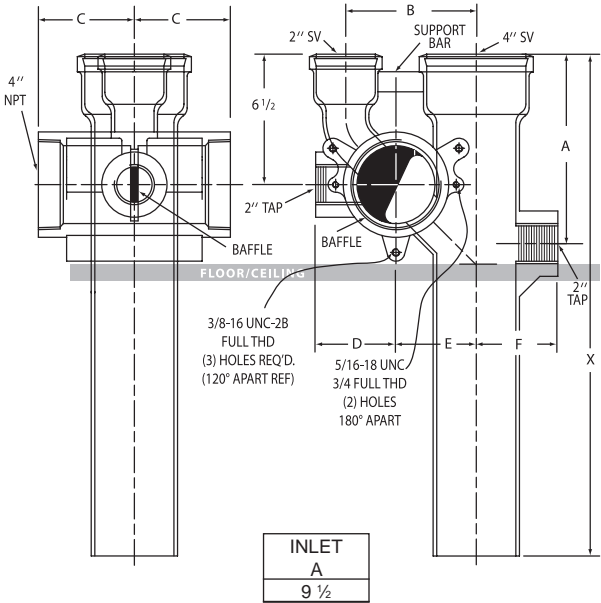

INLET
A
9 1/2

NOTES:

1. Double Vertical Offset Back Outlet Starter Fitting
2. 4" Stack with 2" Vent & Inlets
3. Face Plate Package Not Included

PART NO. SV 976

Double Starter Fitting with 4" Hub and 2" Tapped "A" Side Inlet
(Designed for use above or in the floor with back-outlet or bottom-outlet water closets; Fitting has a baffle)

Size	A	B	C	D	E	F	X	Weight
4 with A Inlet	6 1/2	6 1/2	6 1/2	4	4	4 1/16	25	50.8

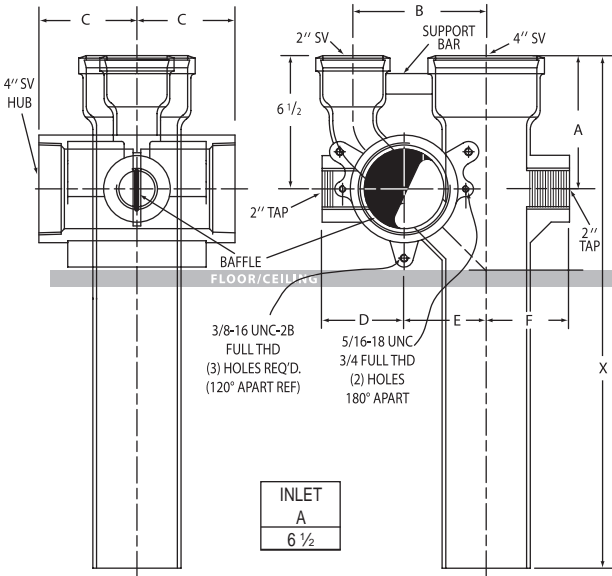

PART NO. SV 976

**Double Starter Fitting with 4" Hub and
2" Tapped "A" and "B" Side Inlets**

**(Designed for use above or in the floor with back-outlet or bottom-outlet
water closets; Fitting has a baffle)**

Size	A	B	C	D	E	X	Weight
4 with A & B Inlets	6 1/2	18	6 1/2	6 1/2	4 1/16	25	56.6

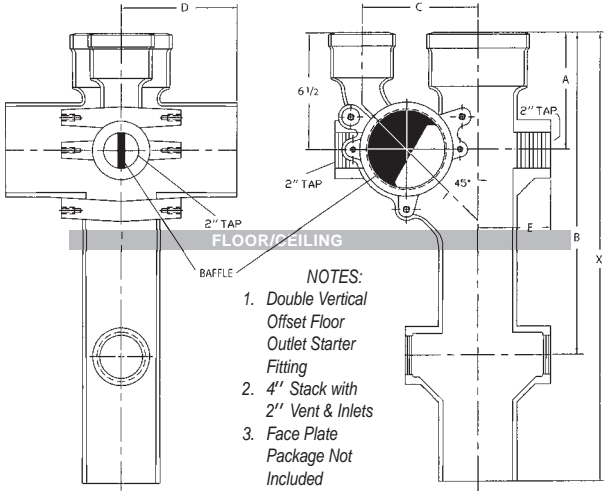

INLET	
A	B
6 1/2	18

PART NO. SV 982

Tapped By-Pass Vent Fitting

Size	A	B	C	D	E	F	Weight
2x2	18	10	6½	3½	3	5¼	11.3

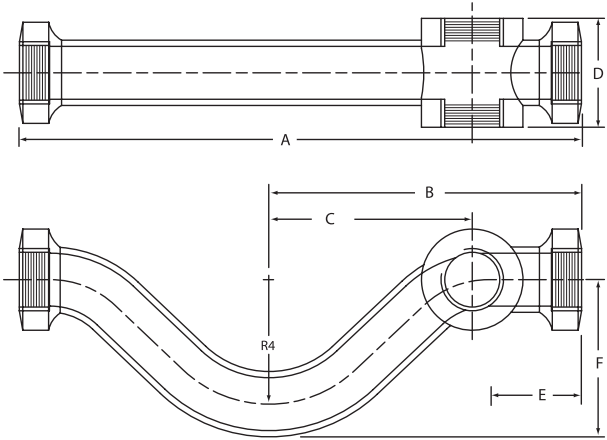

PART NO. SV 985

Tapped Bath Vent Wye

Size	A	B	C	D	Weight
2x2	4 1/16	5	3 1/4	2 1/2	8.4

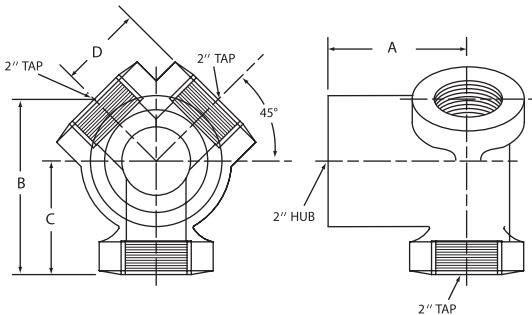

**S
E
R
V
I
C
E**

PART NO. SV 1739R

Right Hand Vented Closet Tee with 2" 45° Taps
(Designed for use above the floor)

Size	A	B	C	D	E	F	G	Weight
4x2x4x2	18	6 ³ / ₄	8 ¹ / ₄	4 ⁵ / ₈	3 ⁵ / ₈	4 ¹ / ₂	2 ³ / ₄	51.1

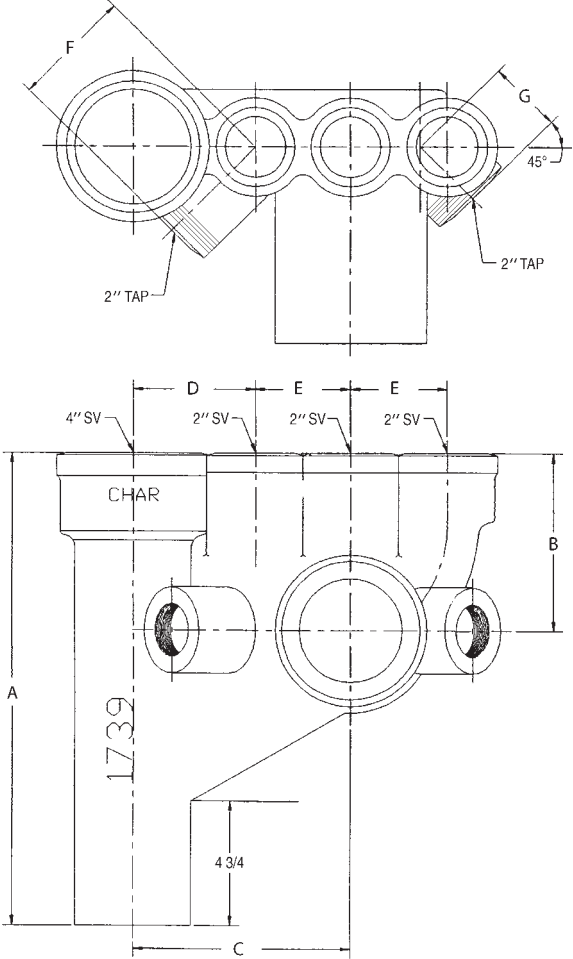

PART NO. SV 1739L

Left Hand Vented Closet Tee with 2" 45° Taps
(Designed for use above the floor)

Size	A	B	C	D	E	F	G	Weight
4x2x4x2	18	6 ³ / ₄	8 ¹ / ₄	4 ⁵ / ₈	3 ⁵ / ₈	4 ¹ / ₂	2 ³ / ₄	51.0

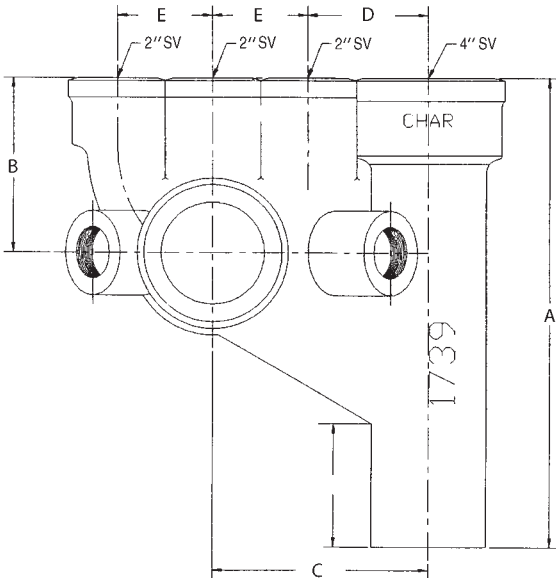
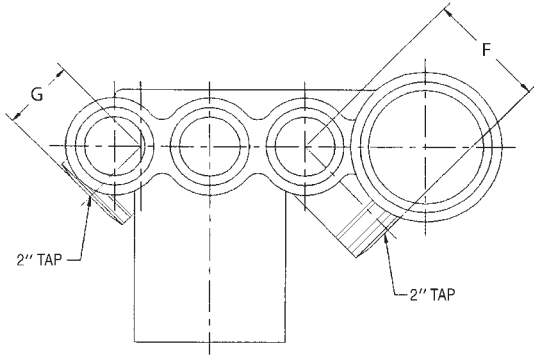

S
E
R
V
I
C
E

PART NO. SV 1739 D

Vented Closet Cross with 2" 45° Taps
(Designed for use above the floor)

Size	A	B	C	D	E	F	G	Weight
4x2x4x2	18	6 ³ / ₄	8 ¹ / ₄	4 ⁵ / ₈	3 ⁵ / ₈	4 ¹ / ₂	2 ³ / ₄	57.5

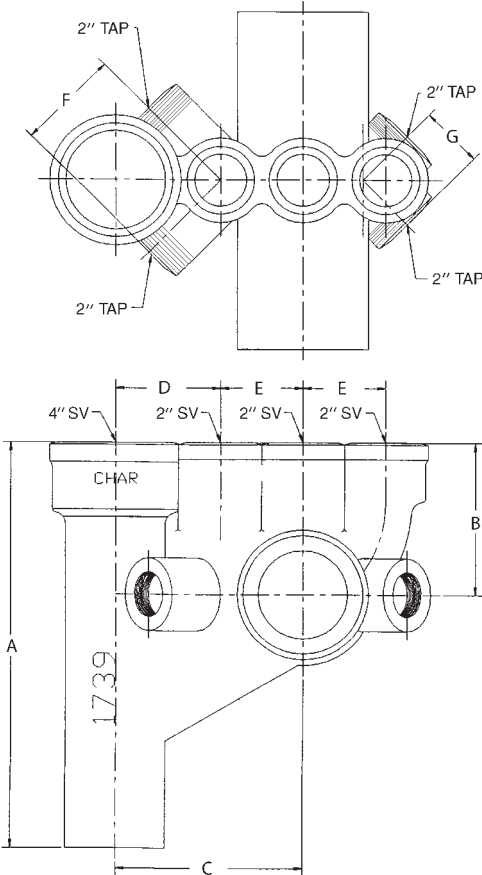

PART NO. SV 1801

Tapped Harp Fitting

Size	A	B	C	Weight
2 X 2 X 2	117/16	2	35/8	15.5

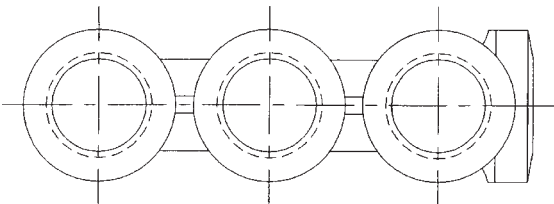
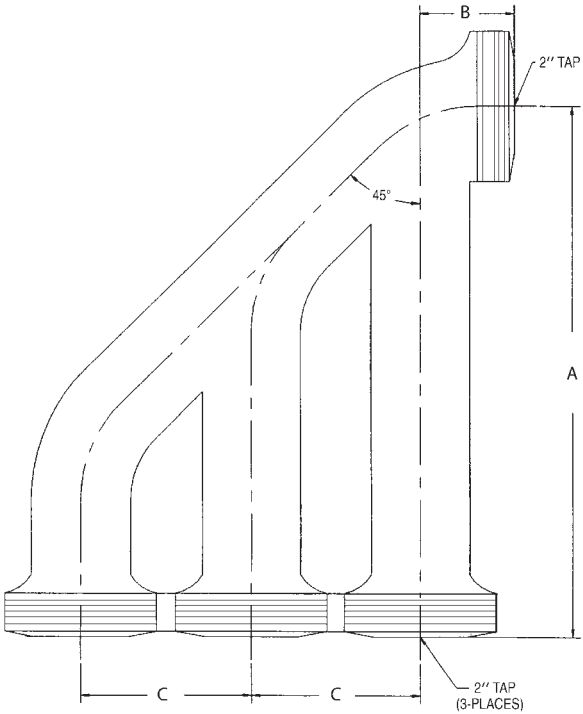

S
E
R
V
I
C
E

MULTI-STORY INSTALLATION

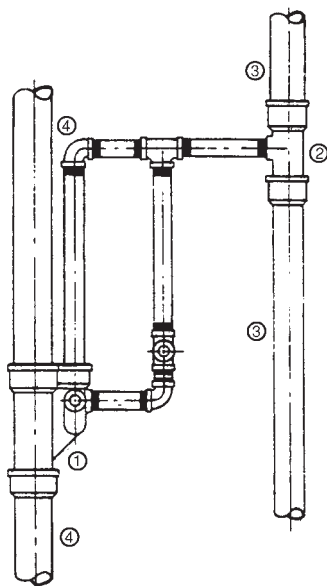

- ① SV 581 4x2x2 Double Sink Stack — 1770
- ② SV 83 3x2 Straight Tapped Tee
- ③ 3x10 Single Hub Pipe
- ④ 4x10 Single Hub Pipe

Extra Heavy

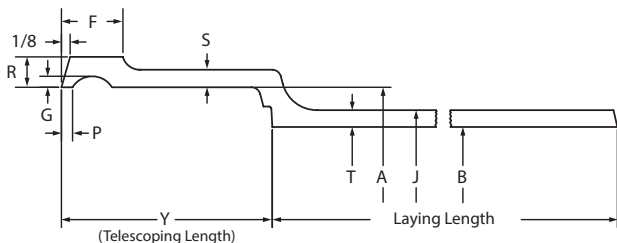

PIPE - EXTRA-HEAVY*

Size	Telescoping Length	Hub I.D.	Barrel		Nominal Thickness
	Y	A	O.D. J	I.D. B	T
2"	2.50	3.06	2.38	2.00	0.19
3"	2.75	4.19	3.50	3.00	0.25
4"	3.00	5.19	4.50	4.00	0.25
5"	3.00	6.19	5.50	5.00	0.25
6"	3.00	7.19	6.50	6.00	0.25
8"	3.50	9.50	8.62	8.00	0.31
10"	3.50	11.62	10.75	10.00	0.37
12"	4.25	13.75	12.75	12.00	0.37
15"	4.25	16.95	15.88	15.00	0.44

CHARLOTTE® SPEED-PAK FIVE FOOT PIPE BUNDLES

EXTRA HEAVY WEIGHT				
	SIZE	PIECES	WEIGHT	HEIGHT
Single Hub	2"	84	2099	18"
	3"	45	1998	20"
	4"	33	1968	21"
	5"	23	1695	25"
	6"	18	1465	23"
	8"	11	1552	24"
	10"	8	1574	29"
	12"	6	1471	29"
Double Hub	15"	2	700	20"
	2"	84	2207	23"
	3"	45	2007	24"
	4"	33	1992	25"
	5"	23	1847	29"
6"	18	1535	28"	

* For additional dimensional information please see the Cast Iron Technical and Installation Manual.

CHARLOTTE® SPEED-PAK
30" SINGLE HUB PIPE BUNDLES

EXTRA HEAVY WEIGHT				
30" Single Hub	SIZE	PIECES	WEIGHT	HEIGHT
	8 x 30"	11	835	26"
	10 x 30"	8	901	24"
	12 x 30"	6	816	30"
	15 x 30"	2	394	19"

TEN FOOT PIPE BUNDLES

EXTRA HEAVY WEIGHT				
Single Hub	SIZE	PIECES	WEIGHT	HEIGHT
	2 x 10'	48	2173	12"
	3 x 10'	30	2517	15"
	4 x 10'	24	2517	18"
	5 x 10'	21	2820	20"
	6 x 10'	12	1879	16"
	8 x 10'	8	1968	21"
	10 x 10'	6	2252	25"
	12 x 10'	3	1413	15"
	15 x 10'	2	1353	20"

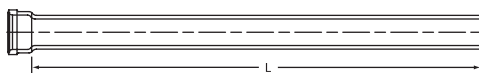
PART NO. XH 1

Pipe, 5' Lengths, Single Hub

Size	L	Weight
2" x 5'	5'	25.0
3" x 5'	5'	44.4
4" x 5'	5'	59.6
5" x 5'	5'	73.7
6" x 5'	5'	81.4
8" x 5'	5'	141.1
10" x 5'	5'	196.7
12" x 5'	5'	245.2
15" x 5'	5'	350.0

Weights are approximate and are for shipping purposes only.

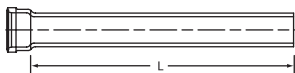
PART NO. XH 1A



Pipe, 30'' Lengths, Single Hub

Size	L	Weight
8'' x 30''	30''	75.9
10'' x 30''	30''	112.6
12'' x 30''	30''	136.0
15'' x 30''	30''	197.0

PART NO. XH 2

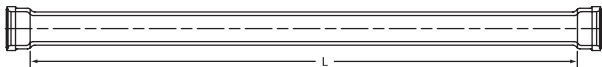

Pipe, 5' Lengths, Double Hub

Size	L	Weight
2'' x 5'	4' 9 1/2''	26.3
3'' x 5'	4' 9 1/4''	44.6
4'' x 5'	4' 9''	60.4
5'' x 5'	4' 9''	80.3
6'' x 5'	4' 9''	85.3

PART NO. XH 3

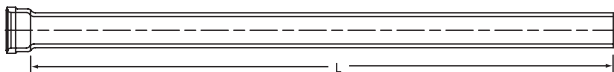

Pipe, 10' Lengths, Single Hub

Size	L	Weight
2'' x 10'	10'	45.3
3'' x 10'	10'	83.9
4'' x 10'	10'	104.9
5'' x 10'	10'	134.3
6'' x 10'	10'	156.6
8'' x 10'	10'	246.1
10'' x 10'	10'	375.4
12'' x 10'	10'	471.0
15'' x 10'	10'	676.4

PART NO. XH 4

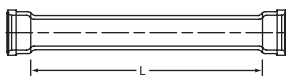

Pipe, 30" Lengths, Double Hub

Size	L	Weight
2" x 30"	25"	15.0
3" x 30"	24 1/2"	26.0
4" x 30"	24"	33.0

EXTRA
HEAVY

PART NO. XH 900

Extra Heavy Charlotte Seal Gasket

Size	A	D	F	G	H	Weight
2	3 1/2	2 3/8	2 9/32	3 3/16	1 7/8	0.3
3	4 15/16	3 1/2	3 1/2	4 1/2	2 1/4	0.4
4	5 3/4	4 7/32	4 13/32	5 7/16	2 1/4	0.6
5	6 3/4	5 1/2	5 1/2	6 3/16	2 1/2	0.7
6	8	6 1/2	6 1/2	7 3/8	2 1/2	0.9
8	10	8 1/2	8 5/16	9 1/2	3	1.6
10	12 1/2	10 3/4	10 1 1/32	11 1/2	3	2.0
12	14 7/16	12 5/8	12 5/8	14	3	2.8

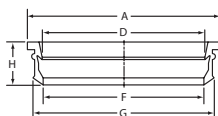

PART NO. XH 950

Extra Heavy Quick-Tite Gasket

Size	A	D	F	G	H	Weight
4	6 1/8	4 1/4	4 13/32	5 11/16	1 13/16	0.6
15	17 3/4	15 13/32	15	16 7/8	3 1/4	5.0

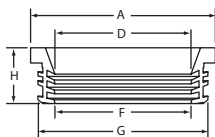

PART NO. XH 5

Quarter Bend

Size	D	X	Weight
2	6	3 $\frac{1}{4}$	6.3
3	7	4	11.1
4	8	4 $\frac{1}{2}$	15.5
5	8 $\frac{1}{2}$	5	18.5
6	9	5 $\frac{1}{2}$	25.8
8	11 $\frac{1}{2}$	6 $\frac{5}{8}$	47.0
10	12 $\frac{1}{2}$	7 $\frac{5}{8}$	80.0
12	15	8 $\frac{3}{4}$	142.0
15	16 $\frac{1}{2}$	10 $\frac{1}{4}$	173.9

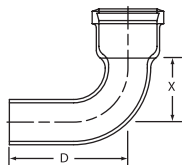

PART NO. XH 7

Sixth Bend

Size	D	X	Weight
2	4 $\frac{3}{4}$	2	6.0
3	5 $\frac{1}{2}$	2 $\frac{1}{2}$	7.2
4	6 $\frac{5}{16}$	2 $\frac{13}{16}$	14.0
6	6 $\frac{7}{8}$	3 $\frac{3}{8}$	21.0

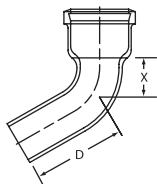

PART NO. XH 8

Eighth Bend

Size	D	X	Weight
2	4 ¹ / ₄	1 ¹ / ₂	4.7
3	4 ¹⁵ / ₁₆	1 ¹⁵ / ₁₆	8.8
4	5 ¹¹ / ₁₆	2 ³ / ₁₆	12.4
5	5 ⁷ / ₈	2 ³ / ₈	15.0
6	6 ¹ / ₁₆	2 ⁹ / ₁₆	18.9
8	8	3 ¹ / ₈	36.2
10	8 ³ / ₈	3 ¹ / ₂	59.7
12	10 ⁵ / ₁₆	4 ¹ / ₁₆	90.0
15	10 ¹⁵ / ₁₆	4 ¹¹ / ₁₆	122.0

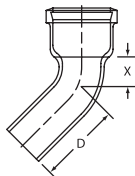

PART NO. XH 9

Sixteenth Bend

Size	D	X	Weight
2	3 ⁵ / ₈	7 ⁷ / ₈	4.6
3	4 ³ / ₁₆	1 ³ / ₁₆	9.1
4	4 ¹³ / ₁₆	1 ⁵ / ₁₆	9.5
5	4 ⁷ / ₈	1 ³ / ₈	13.8
6	5	1 ¹ / ₂	16.0
8	6 ¹¹ / ₁₆	1 ¹³ / ₁₆	31.8
10	6 ⁷ / ₈	2	53.0
12	8 ⁵ / ₈	2 ³ / ₈	65.0
15	8 ⁷ / ₈	2 ⁵ / ₈	103.0

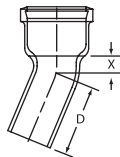

PART NO. XH 26

Long Eighth Bend

Size	D	X	Weight
4 x 18	18	2 ³ / ₁₆	26.0



PART NO. XH 29

Short Sweep Bend

Size	D	X	Weight
2	8	5 ¹ / ₄	7.2
3	9	6	13.0
4	10	6 ¹ / ₂	18.2
5	10 ¹ / ₂	7	23.8
6	11	7 ¹ / ₂	28.4
8	13 ¹ / ₂	8 ⁵ / ₈	57.0
10	14 ¹ / ₂	9 ⁵ / ₈	90.0
12	17	10 ³ / ₄	136.0

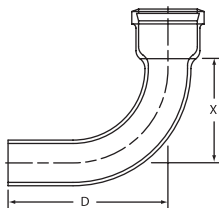

PART NO. XH 30

Long Sweep Bend

Size	D	X	Weight
2	11	8 ¹ / ₄	9.0
3	12	9	16.6
4	13	9 ¹ / ₂	23.6
5	13 ¹ / ₂	10	30.0
6	14	10 ¹ / ₂	38.2
8	16 ¹ / ₂	11 ⁵ / ₈	58.6
10	17 ¹ / ₂	12 ⁵ / ₈	109.0
12	20	13 ³ / ₄	136.0
15	21 ¹ / ₂	15 ¹ / ₄	213.3

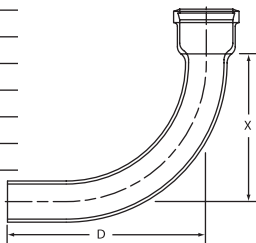

PART NO. XH 33

**Combination Wye & Eighth Bend
 (Long Turn Pattern)**

Size	G	H	X	X'	Weight
2 x 2	4	3 ³ / ₈	8	4 ⁷ / ₈	9.7
3 x 2	4 ³ / ₁₆	4	9	5 ³ / ₄	16.0
3 x 3	5	5 ¹ / ₁₆	10 ¹ / ₂	7	18.2
4 x 2	3 ¹¹ / ₁₆	4 ¹ / ₂	9	6 ¹ / ₄	18.9
4 x 3	4 ¹ / ₂	5 ⁹ / ₁₆	10 ¹ / ₂	7 ¹ / ₂	22.0
4 x 4	4 ¹ / ₂	7 ¹ / ₂	12	9	28.1
5 x 4	4 ¹ / ₄	7 ⁵ / ₁₆	12	9 ¹ / ₂	29.3
5 x 5	5 ¹ / ₂	8 ⁵ / ₈	13 ¹ / ₂	11	33.7
6 x 2	2 ¹¹ / ₁₆	5 ¹ / ₂	9	7 ¹ / ₄	22.0
6 x 3	3 ¹ / ₈	6 ⁹ / ₁₆	10 ¹ / ₂	8 ¹ / ₂	30.4
6 x 4	4 ¹ / ₄	7 ¹³ / ₁₆	12	10	38.5
6 x 6	5 ³ / ₄	10 ⁵ / ₁₆	15	12 ⁷ / ₈	53.5
8 x 4	4 ³ / ₄	8 ¹³ / ₁₆	13 ¹ / ₂	11	54.0
8 x 6	6 ⁵ / ₁₆	11 ⁵ / ₁₆	16 ¹ / ₂	13 ⁷ / ₈	70.5
8 x 8	7 ¹¹ / ₁₆	13 ⁷ / ₈	19 ¹ / ₂	17	107.4

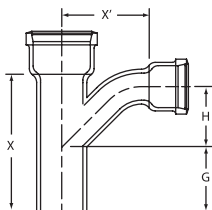

EXTRA HEAVY

PART NO. XH 35F

**Double Combination Wye & Eighth Bend
 (Long Turn Pattern)**

Size	G	H	X	X'	Weight
4 x 4	5 ¹ / ₄	6 ¹³ / ₁₆	12	9	44.0
6 x 4	4 ¹ / ₄	7 ¹³ / ₁₆	12	10	43.0

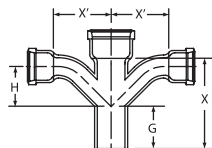

PART NO. XH 43

Sanitary Tee

Size	G	X	X'	Weight
2 x 2	6 ¹ / ₄	8	2 ⁷ / ₈	8.7
3 x 2	7	9	4	14.2
3 x 3	7 ¹ / ₂	10	4	17.1
4 x 2	7	9	4 ¹ / ₂	17.4
4 x 3	7 ¹ / ₂	10	4 ¹ / ₂	18.3
4 x 4	8	11	4 ¹ / ₂	22.5
5 x 5	8 ¹ / ₂	12	5	28.0
6 x 3	7 ¹ / ₂	10	5 ¹ / ₂	24.4
6 x 4	8	11	5 ¹ / ₂	28.0
6 x 6	9	13	5 ¹ / ₂	35.4
8 x 4	9 ³ / ₄	13	6 ¹ / ₂	51.0
8 x 6	10 ³ / ₄	15	6 ¹ / ₂	54.5
8 x 8	11 ³ / ₄	17	6 ⁵ / ₈	72.0
10 x 6	10 ³ / ₄	15	7 ¹ / ₂	77.0
10 x 8	11 ³ / ₄	17	7 ⁵ / ₈	95.0
10 x 10	12 ³ / ₄	19	7 ⁵ / ₈	115.0
12 x 8	13	18 ¹ / ₂	8 ⁵ / ₈	126.0
12 x 12	15	22 ¹ / ₂	8 ³ / ₄	173.0
15 x 8	13	18 ¹ / ₂	10 ¹ / ₈	180.0
15 x 15	16 ¹ / ₂	25 ¹ / ₂	10 ¹ / ₄	280.0

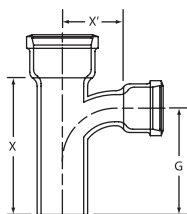

PART NO. XH 44

Size	Wye			Weight
	G	X	X'	
2 x 2	4	8	4	9.0
3 x 2	4 ³ / ₁₆	9	5	13.2
3 x 3	5	10 ¹ / ₂	5 ¹ / ₂	17.2
4 x 2	3 ⁵ / ₈	9	5 ³ / ₄	16.8
4 x 3	4 ⁷ / ₁₆	10 ¹ / ₂	6 ¹ / ₄	20.6
4 x 4	5 ¹ / ₄	12	6 ³ / ₄	23.7
5 x 3	3 ⁷ / ₈	10 ¹ / ₂	7	23.7
5 x 4	4 ¹ / ₁₆	12	7 ¹ / ₂	28.3
5 x 5	5 ¹ / ₂	13 ¹ / ₂	8	31.6
6 x 3	3 ³ / ₈	10 ¹ / ₂	7 ³ / ₄	26.8
6 x 4	4 ³ / ₁₆	12	8 ¹ / ₄	31.9
6 x 5	4 ¹⁵ / ₁₆	13 ¹ / ₂	8 ³ / ₄	33.8
6 x 6	5 ³ / ₄	15	9 ¹ / ₄	41.2
8 x 4	4 ³ / ₄	13 ¹ / ₂	9 ¹ / ₂	50.2
8 x 6	6 ⁵ / ₁₆	16 ¹ / ₂	10 ¹ / ₂	61.5
8 x 8	7 ¹ / ₁₆	19 ¹ / ₂	11 ¹³ / ₁₆	86.6
10 x 4	3 ⁹ / ₁₆	13 ¹ / ₂	11 ¹ / ₈	72.0
10 x 6	5 ¹ / ₈	16 ¹ / ₂	12 ¹ / ₈	84.0
10 x 8	6 ¹ / ₂	19 ¹ / ₂	13 ⁷ / ₁₆	101.7
10 x 10	8	22 ¹ / ₂	14 ¹ / ₂	137.0
12 x 6	5 ¹ / ₁₆	18	13 ⁷ / ₁₆	108.0
12 x 8	7 ¹ / ₁₆	21	14 ³ / ₄	140.0
12 x 10	8 ⁹ / ₁₆	24	15 ¹³ / ₁₆	180.0
12 x 12	10 ¹ / ₈	27	16 ⁷ / ₈	198.0
15 x 4	6 ⁷ / ₈	15	15	153.0
15 x 8	5 ³ / ₈	21	17 ¹ / ₁₆	219.0
15 x 10	6 ⁷ / ₈	24	18 ¹ / ₈	229.0
15 x 12	8 ⁷ / ₁₆	27	19 ⁹ / ₁₆	236.0
15 x 15	10 ³ / ₄	31 ¹ / ₂	20 ³ / ₄	309.4

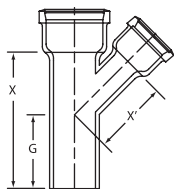

PART NO. XH 79

Washington Test Tee

Size	IPS		E'	G	X	Weight
	Tap					
3	4		2 ⁷ / ₈	7 ¹ / ₈	10 ³ / ₄	13.9
4	4		3 ¹ / ₄	7 ¹ / ₄	10 ⁵ / ₈	19.9
5	5		3 ⁵ / ₈	7	11	24.4
6	6		4	8 ³ / ₄	13	42.2
8	8		5	11	16 ³ / ₈	58.5

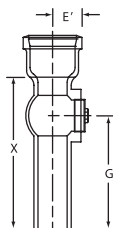

PART NO. XH 80

Cleanout Tee with Brass Plug

Size	IPS		E'	G	X	Weight
	Tap					
3	2		2 ¹ / ₂	7	9	11.3
4	3		3	8	11	15.5
5	4		3 ¹ / ₂	8 ¹ / ₂	12	22.9
6	4		4 ¹ / ₄	9	13	26.9

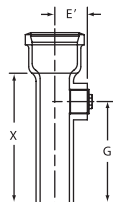

PART NO. XH 81S

Miami Test Tee

Size	IPS		E'	G	X	Weight
	Tap					
4	4		3	7 ¹ / ₄	11	16.0

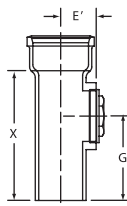

PART NO. XH 84

Sanitary Tapped Tee

Size	E'	G	X	Weight
4 X 2	4 ¹ / ₁₆	7	9	14.3

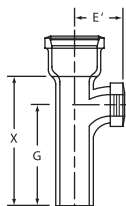

PART NO. XH 85

Tapped Wye

Size	G	X	X'	Weight
4 X 2	4 ¹ / ₄	9	6	13.8

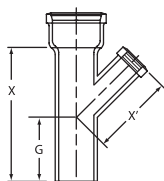

PART NO. XH 109

Sanitary Cross

Size	G	X	X'	Weight
4	8	11	4 ¹ / ₂	27.0

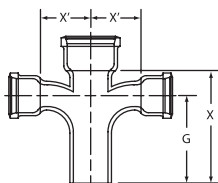

PART NO. XH 110

Double Wye

Size	G	X	X'	Weight
2	4	8	4	13.1
4 x 3	4 ^{7/16}	10 ^{1/2}	6 ^{1/4}	26.9
4	5 ^{1/4}	12	6 ^{3/4}	28.2
6 x 4	4 ^{3/16}	12	8 ^{1/4}	39.8
6	5 ^{3/4}	15	9 ^{1/4}	45.0
8	7 ^{1/16}	19 ^{1/2}	11 ^{13/16}	119.0
10	8	22 ^{1/2}	14 ^{1/2}	182.0
12	10 ^{1/8}	27	16 ^{7/8}	295.0
15	10 ^{3/4}	31 ^{1/2}	22	384.8

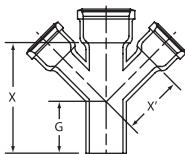

PART NO. XH 143

Reducer

Size	X	Weight
3 x 2	4 ^{3/4}	6.0
4 x 2	5	7.0
4 x 3	5	8.9
5 x 3	5	11.0
5 x 4	5	11.0
6 x 3	5	12.0
6 x 4	5	12.2
6 x 5	5	12.6
8 x 4	6	19.1
8 x 5	6	19.5
8 x 6	6	19.0
10 x 4	6	28.0
10 x 6	6	30.0
10 x 8	6	35.0
12 x 4	6 ^{1/2}	36.8
12 x 6	6 ^{1/2}	46.0
12 x 8	6 ^{1/2}	43.0
12 x 10	6 ^{1/2}	50.0
15 x 8	6 ^{1/2}	55.5
15 x 10	6 ^{1/2}	57.0
15 x 12	6 ^{1/2}	62.0

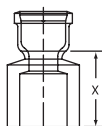

PART NO. XH 144

Reducer Increaser

Size	X	Weight
4 x 6	9	15.8
6 x 8	12	33.8

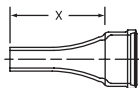

PART NO. XH 153

Double Hub Fitting

Size	X	Weight
2	1 1/4	5.0
4	1 1/2	9.4
5	1 1/2	12.0
6	1 1/2	14.0
8	1 1/2	28.0
10	1 1/2	43.0
12	1 1/2	54.0
15	1 1/2	80.0

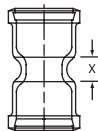

PART NO. XH 155

Pipe Plug

Size	X	Weight
2	3 1/2	1.4
4	4	4.7
6	4	8.0
8	4 1/2	15.0
10	4 1/2	29.0
12	5 1/4	32.0
15	5 1/4	44.0

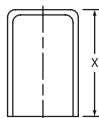

PART NO. XH 169

"P" Trap

Size	J	X	Weight
2	4	9½	7.9
3	5½	12	17.2
4	6½	14	27.2
6	8½	17	45.2
8	10½	22½ ₁₆	120.0

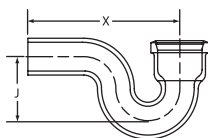

PART NO. XH 174

Running Trap with Single Hub Vent

Size	Vent Size	C	J	X	X'	Weight
3	3	5	5½	15	2½	22.8
4	4	6	6½	17½	3	35.6
5	4	7	7½	19½	3½	46.0
6	4	8	8½	21½	4	59.0

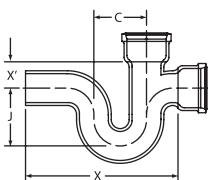

PART NO. XH 175

Running Trap with Double Hub Vent

Size	Vent Size	C	J	X	X'	Weight
3	3	5	5½	15	2½	30.0
4	4	6	6½	17½	3	37.4
5	4	7	7½	19½	3½	50.0
6	4	8	8½	21½	4	65.5
6	6	8	8½	21½	4	71.0
8	4	10	11	27 ⁵ / ₈	5¼	127.0
8	6	10	11	27 ⁵ / ₈	5¼	119.6
10	8	12	13	31 ⁵ / ₈	6¼	193.0
12	6	15	15	38 ³ / ₄	7¼	274.0

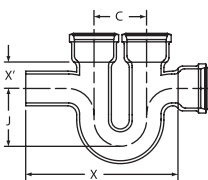

PART NO. XH 180

Deep Seal "P" Trap

Size	X	J	Weight
2	9½	6	9.8
3	12	7	20.3
4	14	8	29.0

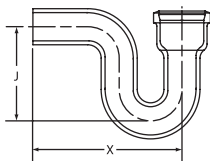

EXTRA HEAVY

PART NO. XH 184^(T)

Improved Running Trap with Double Cleanout and Tee Branch

Size	Vent Size	E	G	X	X'	Weight
4	3	5¼	6¼	20½	5½	41.8
4	4	5⅜	6¼	20½	5½	42.9

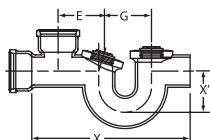

PART NO. XH 198

"P" Trap with ½" Heel Tap

Size	X	J	A	Weight
2	9½	4	4	9.0
3	12	5½	4⅜	17.0
4	14	6½	4⅝	27.0

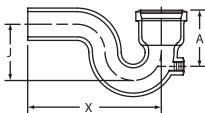

^(T) Note: 3½" IPS tap

PART NO. XH 230

**Iron Body Cleanout,
 Body Only, Less Brass Plug**

Size	Tap Size	A	Weight
2 ^(S)	1½	3½	1.7
3 ^(S)	2½	3¾	3.2
4	3½	4¼	4.3
5 ^(S)	4	4¼	6.5
6	5	4¼	6.6
8	6	4½	13.1
10	6	4½	21.0
12	6	5¼	38.0
15	6	5¼	52.8

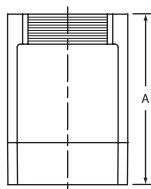

PART NO. XH 253

Sission Insertable Joint

Size	A	B	C	Weight
4	14½	7	6	17.1
6	16 ³ / ₁₆	8½	6	26.2

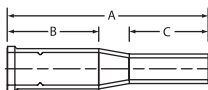

PART NO. XH 549

Roof Iron

Size	A	B	C	D	E	Weight
4	10 ⁷ / ₁₆	5 ³ / ₈	4 ¹³ / ₁₆	3 ³ / ₁₆	2½	8.2

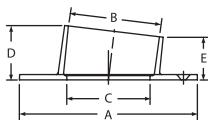

^(S) Size available only with Southern Raised-Head Brass Plug installed

Plugs

PART NO. PLG 410

Ohio Code Brass Plug

Size	D	H	Weight
10	$10^{23/32}$	$2^{1/32}$	10.6

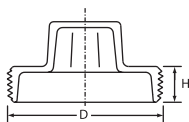

PART NO. PLG 430

Southern Code Brass Plug

Size	D	H	Weight
1 1/2	$1^{57/64}$	$49/64$	0.2
2	$2^{23/64}$	$49/64$	0.3
2 1/2	$2^{55/64}$	$51/64$	0.4
3	$3^{15/32}$	$57/64$	0.6
3 1/2	$3^{63/64}$	$57/64$	0.7
4	$4^{31/64}$	$61/64$	1.1
5	$5^{35/64}$	$61/64$	1.5
6	$6^{19/32}$	$17/32$	2.5
8	$8^{39/64}$	$19/32$	4.0

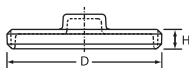

PART NO. PLG 440

Southern Code Countersunk Brass Plug

Size	D	H	Weight
1 1/2	$1^{57/64}$	$13/32$	0.2
2	$2^{23/64}$	$7/16$	0.3
3	$3^{15/32}$	$33/64$	0.6
3 1/2	$3^{63/64}$	$33/64$	0.8
4	$4^{31/64}$	$35/64$	0.9
5	$5^{35/64}$	$11/16$	1.7
6	$6^{19/32}$	$11/16$	2.3

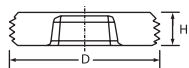

PART NO. PLG 450

Cast Iron Plug

Size	D	H	Weight
6	$6^{35/64}$	$1^{17/64}$	4.2
10	$10^{39/64}$	$1^{31/32}$	9.0

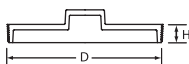

CHARLOTTE

PIPE AND FOUNDRY COMPANY®

This is to verify that products manufactured by Charlotte Pipe and Foundry, Cast Iron Division, are manufactured in the United States and conform to the following standards:

SERVICE HUB AND SPIGOT PIPE AND FITTINGS

All cast iron soil pipe and fittings shall be marked with the collective trademark of the Cast Iron Soil Pipe Institute (CISPI).

ASTM A 74

Listed by NSF® International to the UP Code

ISO 9001:2015 Certified

EXTRA HEAVY HUB AND SPIGOT PIPE AND FITTINGS

All cast iron soil pipe and fittings shall be marked with the collective trademark of the Cast Iron Soil Pipe Institute (CISPI).

ASTM A 74

Listed by NSF® International to the UP Code

ISO 9001:2015 Certified

HUBLESS PIPE AND FITTINGS

All cast iron soil pipe and fittings shall be marked with the collective trademark of the Cast Iron Soil Pipe Institute (CISPI).

CISPI Standard 301

ASTM A 888

Listed by NSF® International to the UP Code

ISO 9001:2015 Certified

HUBLESS COUPLINGS

CISPI Standard 310

ASTM C 1277

Certified by NSF® International

HUBLESS HEAVY DUTY COUPLINGS

Meets ASTM C 1540

COMPRESSION GASKETS

ASTM C 564

CISPI HSN 85



LIMITED WARRANTY

Charlotte Pipe and Foundry Company® (Charlotte Pipe®) Products are warranted to be free from manufacturing defects and to conform to currently applicable ASTM standards for a period of five (5) years from date of delivery. Buyer's remedy for breach of this warranty is limited to replacement of, or credit for, the defective product. This warranty excludes any expense for removal or reinstallation of any defective product and any other incidental, consequential, or punitive damages. **This limited warranty is the only warranty made by seller and is expressly in lieu of all other warranties, express and implied, including any warranties of merchantability and fitness for a particular purpose.** No statement, conduct or description by Charlotte Pipe or its representative, in addition to or beyond this Limited Warranty, shall constitute a warranty. This Limited Warranty may only be modified in writing signed by an officer of Charlotte Pipe.

This Limited Warranty will not apply if:

- 1) The Products are used for purposes other than their intended purpose as defined by local plumbing and building codes, and the applicable ASTM standard.
- 2) The Products are not installed in good and workmanlike manner consistent with normal industry standards; installed in compliance with the latest instructions published by Charlotte Pipe and good plumbing practices; and installed in conformance with all applicable plumbing, fire and building code requirements.
- 3) This limited warranty does not apply when the products of Charlotte Pipe are used with the products of other manufacturers that do not meet the applicable ASTM or CISPI standards or that are not marked in a manner to indicate the entity that manufactured them.
- 4) In hubless cast iron installations, this warranty will not apply if products are joined with unshielded hubless couplings. Charlotte Pipe requires that its hubless cast iron pipe and fittings be joined only with shielded hubless couplings manufactured in accordance with CISPI 310, ASTM C 1277 and certified by NSF® International or with Heavy Duty Couplings meeting ASTM C 1540.
- 5) The Products fail due to defects or deficiencies in design, engineering, or installation of the piping system of which they are a part.
- 6) The Products have been the subject of modification; misuse; misapplication; improper maintenance or repair; damage caused by the fault or negligence of anyone other than Charlotte Pipe; or any other act or event beyond the control of Charlotte Pipe.
- 7) The Products fail due to the freezing of water in the Products.
- 8) The Products fail due to contact with chemical agents, fire stopping materials, thread sealant, plasticized vinyl products, or other aggressive chemical agents that are not compatible.
- 9) Pipe outlets, sound attenuation systems or other devices are permanently attached to the surface of Charlotte® PVC, ABS or CPVC products with solvent cement or adhesive glue.

Charlotte Pipe products are manufactured to the applicable ASTM or CISPI standard. Charlotte Pipe and Foundry **cannot** accept responsibility for the performance, dimensional accuracy, or compatibility of pipe, fittings, gaskets, or couplings not manufactured or sold by Charlotte Pipe and Foundry.

Any Charlotte Pipe products alleged to be defective **must** be made available to Charlotte Pipe at the following address for verification, inspection and determination of cause:

Charlotte Pipe and Foundry Company
Attention: Technical Services
2109 Randolph Road
Charlotte, North Carolina 28207

Purchaser must obtain a return materials authorization and instructions for return shipment to Charlotte Pipe of any product claimed defective or shipped in error.

Any Charlotte Pipe product **proved** to be defective in manufacture will be replaced F.O.B. point of original delivery, or credit will be issued, at the discretion of Charlotte Pipe.

4/24/15

WARNING

Testing with or use of compressed air or gas in PVC / ABS / CPVC / Cast Iron pipe or fittings can result in explosive failures and cause severe injury or death.

AIR/GAS



- NEVER test with or transport/store compressed air or gas in PVC / ABS / CPVC / Cast Iron pipe or fittings.
- NEVER test PVC / ABS / CPVC / Cast Iron pipe or fittings with compressed air or gas, or air over water boosters.
- ONLY use PVC / ABS / CPVC / Cast Iron pipe or fittings for water or approved chemicals.
- Refer to warnings on PPFA's website and ASTM D 1785.

Charlotte and Charlotte Pipe are registered trademarks of Charlotte Pipe and Foundry Company.

CHARLOTTE

PIPE AND FOUNDRY COMPANY

PO BOX 35430

CHARLOTTE

NORTH CAROLINA 28235

PHONE (704) 348-6450

(800) 438-6091

FAX (800) 553-1605

WWW.CHARLOTTEPIPE.COM

