

# Bosch Buderus SSB255/399/512 Stainless Steel Condensing Boiler

Engineering  
Submittal  
Sheet



# BOSCH

## Boiler Components

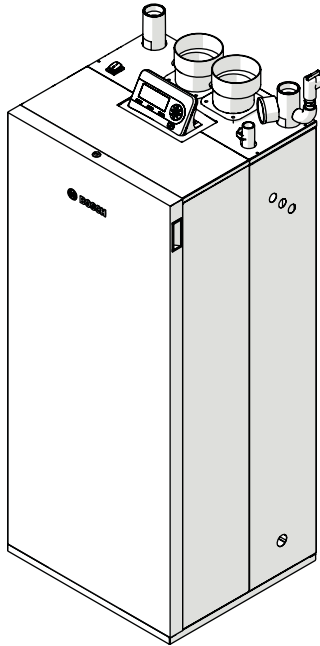

## Engineering Specifications

There shall be provided and installed Bosch Buderus \_\_SSB255 \_\_SSB 399\_\_SSB512 in quantities of\_\_. Bosch Buderus Stainless Steel Boilers referred to as SSB are condensing hot water boiler(s), suitable for direct venting with natural gas. The SSB(s) shall be field convertible to LP.

Boiler(s) shall utilize a plasma welded 316L dual tube stainless steel heat exchanger and burner tube with high quality condensing heating surfaces and patented laser perforated design to diffuse flames consistently throughout the length of the burner tube.

Boiler(s) shall be constructed, tested and labeled in accordance with ASME Section IV and shall bear the ASME stamp. Boilers shall be CSA approved for USA and Canada and have an applicable Canadian Registration Number.

Heat exchanger shall be labeled for 80psig (MAWP) maximum allowable working pressure rating. An integrated pressure sensor shall ensure minimum and maximum water pressures are not exceeded.

Boiler shall be capable of modulating firing from 5:1 turndown continuously based upon supply and return water temperatures, and/or outdoor reset control. Minimal clearances shall be integral to the boiler cabinet design; removable panels shall be used to access heat exchanger, burner components, gas valve and sensors.

Boiler(s) shall be designed for large residential, commercial and light industrial applications.

SSB255 & SSB399 boiler(s) shall be equipped with a 30lb pressure relief valve. SSB512 boiler(s) shall be equipped with a 75lb pressure relief valve.

Boiler(s) shall be equipped with Manual Reset High Limit. Boiler(s) shall be equipped with LWCO (low water cut out) with test button.

SSB512 boiler(s) shall be equipped with Low and High gas pressure switches with manual resets per ASME CSD-1 requirements.

# Bosch Buderus SSB255/399/512 Stainless Steel Condensing Boiler



## Engineering Specifications

Boiler(s) shall have several options for venting including single pipe, twin pipe and concentric.

Boiler(s) shall be installed in a system that meets the water quality standards outlined in the boiler installation manual.

Boiler(s) shall function directly with any hydronic emitter.

Boiler(s) and system connections shall be installed with consideration of total head loss and flow rates in order to adequately size piping and circulator pumps.

Boiler(s) shall be able to be connected to a room thermostat.

Boiler(s) shall be equipped with an outdoor air temperature sensor to control supply temperature for increased fuel efficiency and comfort.

Boiler(s) shall be equipped with an integrated controller that shall monitor and control all combustion process functions, control of the boiler water temperature to a value required by the connected components and shall display current water temperatures or fault conditions with changes in operation status.

The boiler control shall have multiple heating parameters designed for the most common applications with options including:

- 0 – Heating demand (end switch / Thermostat)
- 1 – Weather compensation with heating demand
- 2 – Weather Compensation with full outdoor temperature reset
- 3 – Permanent heat demand
- 4 – Analog Input of Setpoint
- 5 – Analog Input of Modulation Rate

The boiler control shall have multiple domestic hot water heating parameters designed for the most common applications with options including:

- 0 – No DHW
- 1 – Indirect Tank with Sensor
- 2 – Indirect Tank with Aquastat

The boiler control shall have multiple circulator pump parameters designed for the most common applications with options including:

- 0 – 1 Heating – 1 DHW
- 1 – 1 Heating – 1 three way valve to operate DHW
- 2 – 1 System, 1 Heating, 1 DHW
- 3 – 1 System, 1 Heating, 1 1 three way valve to operate DHW
- 4 – 1 System, 1 Heating, DHW controlled by others.

General Data				
	Unit	SSB255	SSB399	SSB512
Boiler category	–	ASME Sect.IV	ASME Sect.IV	ASME Sect.IV
Type of Gas	–	Natural Gas, Propane	Natural Gas, Propane	Natural Gas, Propane
Heat exchanger construction	–	316L Stainless Steel	316L Stainless Steel	316L Stainless Steel
Surface heat exchanger	Sq. Ft (m2)	22.0 (2.0)	27.2 (2.5)	43.0 (4.0)
Gas Connections (NPT)	Ø Inch	1	1	1
Water Connections	Ø Inch	1 ½	1 ½	2
Vent/Air Intake Connections	Ø Inch (Ø mm)	3 (80)	4 (100)	4 (100)
Vent Materials	–	CPVC, PVC, PP, PP Flex, Stainless Steel AL29-4C IPEX type IIA & IIB	CPVC, PVC, PP, PP Flex, Stainless Steel AL29-4C IPEX type IIA & IIB	CPVC, PVC, PP, PP Flex, Stainless Steel AL29-4C IPEX type IIA & IIB
Water Volume	Gallons (Liters)	4.0 (15.2)	4.5 (17.0)	6.0 (23.0)
Weight - dry	Lbs (kg)	198 (90)	220 (100)	242 (110)
Min. clearance to combustibles **	Inch (mm)	2 (50.8)	2 (50.8)	2 (50.8)
Dimension LxWxH	Inch (mm)	21 21/32 x 23 31/32 x 61 9/16 (550x609x1564)	21 21/32 x 23 31/32 x 61 9/16 (550x609x1564)	21 21/32 x 23 31/32 x 61 9/16 (550x609x1564)

\*\* The 2" minimum clearance is required for all sides of the boiler. The boiler may be installed on combustible (wood) floors excluding carpets.

# Bosch Buderus SSB255/399/512 Stainless Steel Condensing Boiler



Performance Data				
	Unit	SSB255	SSB399	SSB512
Max Input*	BTU/hr (kW)	255,000 (75)	399,000 (117)	511,800 (150)
Min Input	BTU/hr (kW)	51,580 (15)	79,800 (23.4)	102,400 (30)
Turndown	Ratio (%)	5:1 (20 %)	5:1 (20 %)	5:1 (20 %)
AFUE*	Efficiency (%)	96.0	NA	NA
Heating Capacity*	BTU/hr (kW)	237,000 (69.5)	NA	NA
Combustion Eff.*	Efficiency (%)	NA	97.6	95.4
Thermal Eff.*	Efficiency (%)	NA	96.8	96.8
Gross Output*	BTU/hr (kW)	NA	386,000 (113.1)	495,000 (145.0)
Net Rating*	BTU/hr (kW)	206,000 (60.3)	336,000 (98.4)	430,000 (126.0)

\* = AHRI certified performance data      NA = Not Applicable

Operational Data				
	Unit	SSB255	SSB399	SSB512
Max. NG Pressure	Inch W.C. (mbar)	10.5 (26.15)	10.5 (26.15)	10.5 (26.15)
Min. NG Pressure	Inch W.C. (mbar)	3.5 (8.72)	3.5 (8.72)	3.5 (8.72)
Max. LPG Pressure	Inch W.C. (mbar)	13 (32.3)	13 (32.3)	13 (32.3)
Min. LPG Pressure	Inch W.C. (mbar)	8 (19.9)	8 (19.9)	8 (19.9)
Max. Allowable Working Pressure (MAWP)	PSI (bar)	80 (5.5)	80 (5.5)	80 (5.5)
Recommended water flow @ max power (ΔT 36 °F / 20 °C)	GPM (m3/h)	14.2 (3.2)	22.2 (5.0)	28.4 (6.5)
Max water flow @ max power (ΔT 27 °F / 15 °C)	GPM (m3/h)	18.9 (4.3)	29.5 (6.7)	37.9 (8.6)
Min water flow @ max power (ΔT 54 °F / 30 °C)	GPM (m3/h)	9.5 (2.2)	14.8 (3.4)	18.9 (4.3)
Min water flow @ min power (ΔT 27 °F / 15 °C)	GPM (m3/h)	3.8 (0.9)	5.9 (1.3)	7.6 (1.7)
Water Pressure Drop @ recommended water flow	Feet Head (mbar)	3.8 (114)	8.3 (250)	21.7 (650)
Water Pressure Drop @ max water flow	Feet Head (mbar)	6.4 (190)	13.8 (410)	37.73 (1120)
Max. operating temperature	°F (°C)	194 (90)	194 (90)	194 (90)
Max HE allowable temperature	°F (°C)	210 (98.9)	210 (98.9)	210 (98.9)
Ambient storage temperature dry	°F (°C)	5 to 150 (-15 to 65)	5 to 150 (-15 to 65)	5 to 150 (-15 to 65)
Ambient functioning temperature	°F (°C)	32 to 120 (0 to 49)	32 to 120 (0 to 49)	32 to 120 (0 to 49)
Electrical Req. 120VAC/1PH/60Hz	-	4 FLA*	4.5 FLA*	4.5 FLA*
Noise rating	dB	46	47	48

\* FLA (Full Load Amperage) - maximum current drawn by the boiler if all pumps reach rated horsepower.

Approval Data			
Approval description	SSB255	SSB399	SSB512
Standard Listings & Approvals	CSA, ASME, AHRI		
Massachusetts Plumbing Board	Approved		
CRN #	W8308.2CL	W8206.2CL	W8205.2C
SCAQMD approval	Approved		

**Boiler Dimensions**

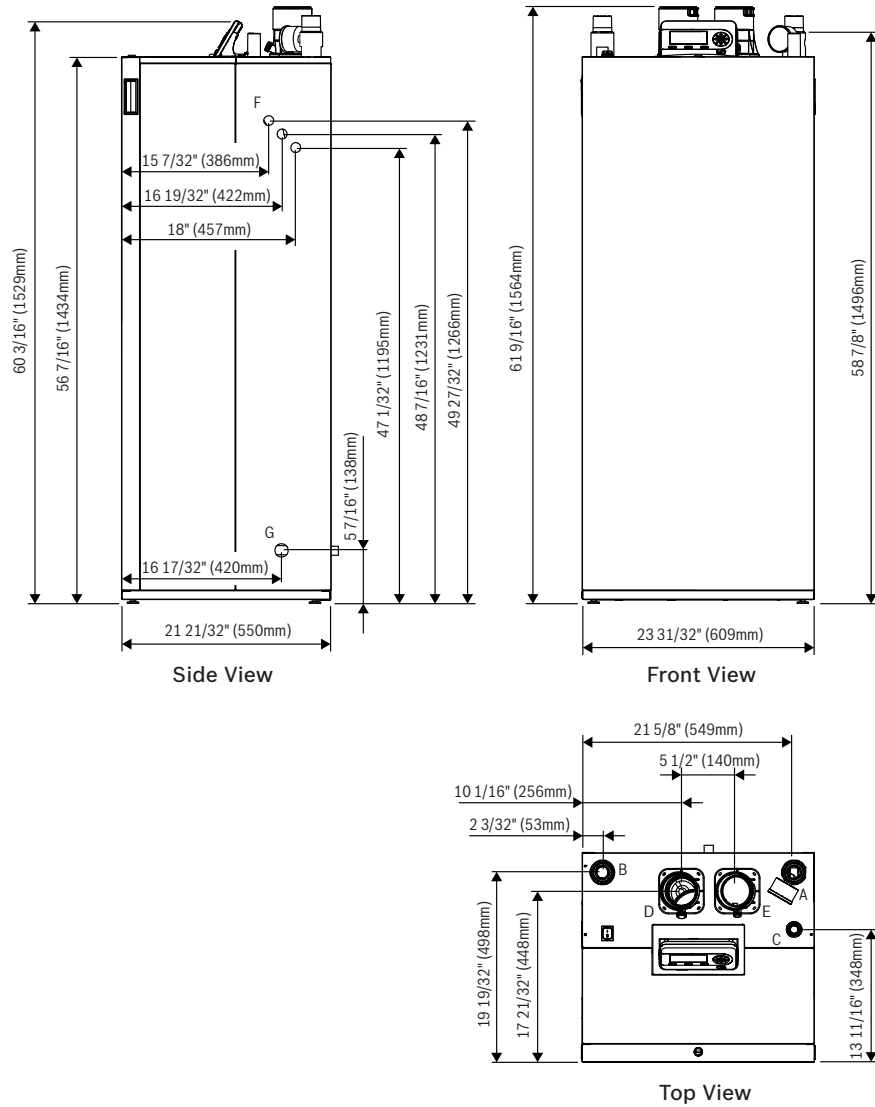

**Boiler Dimensions Data**

Item	Description	Unit	SSB255	SSB399	SSB512
A	System Supply NPT (male)	Inch	1.5	1.5	2
B	System Return NPT (male)	Inch	1.5	1.5	2
C	Gas Inlet NPT (male)	Inch	1	1	1
D	Flue Exhaust	Inch	3	4	4
E	Air Intake	Inch	3	4	4

**Thermal Efficiency Curves SSB255\***

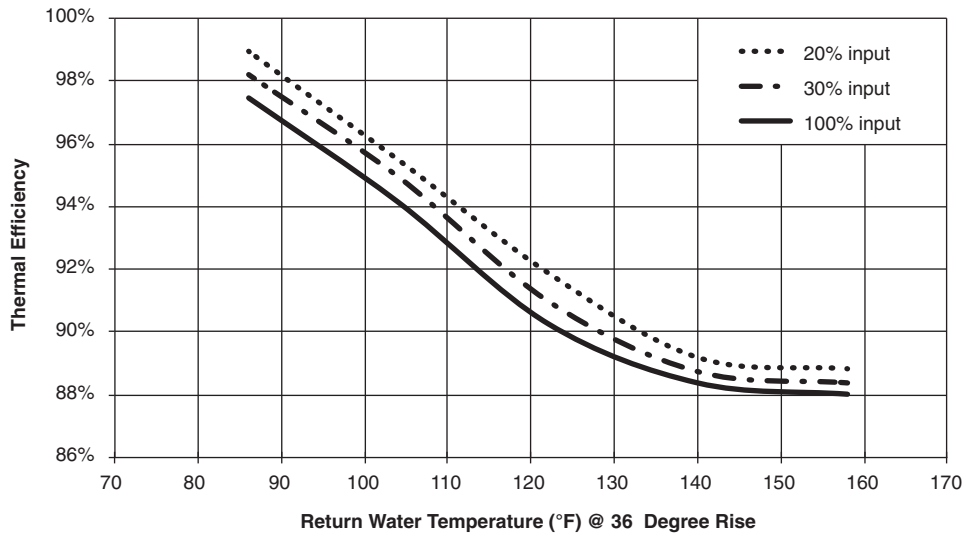

\* This data is provided for reference only. The SSB255 is a residential boiler and has AHRI certified performance in AFUE. [Annual Fuel Utilization Efficiency]

**Thermal Efficiency Curves SSB399**

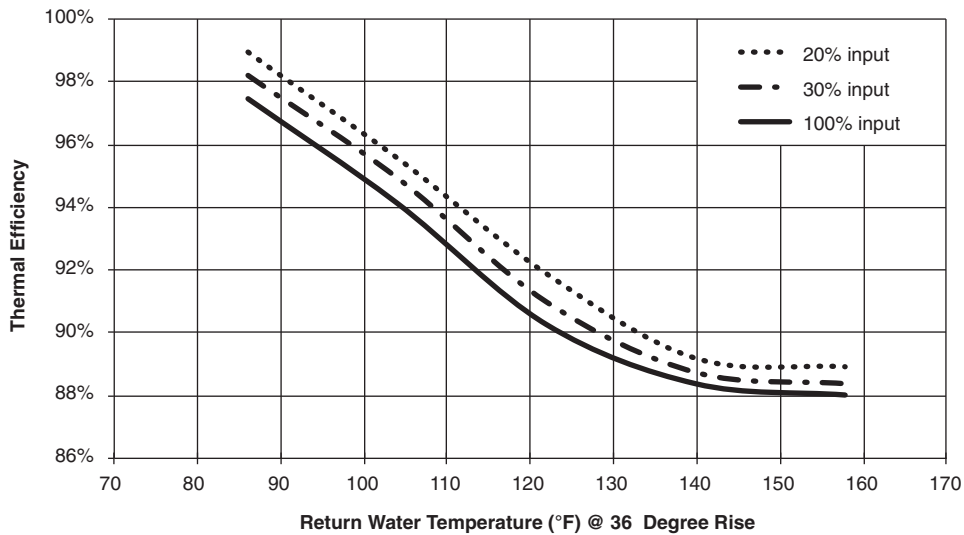



**Thermal Efficiency Curves SSB512**

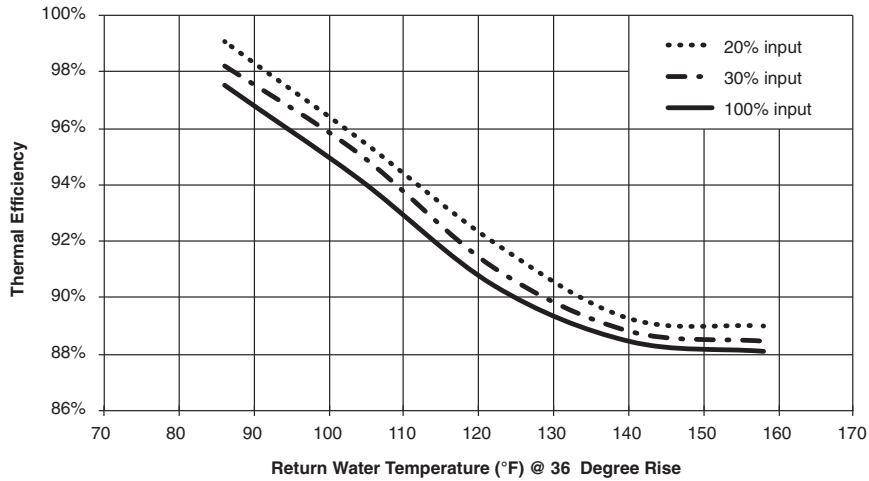

**SSB Pressure Drop Curves**

**SSB255**

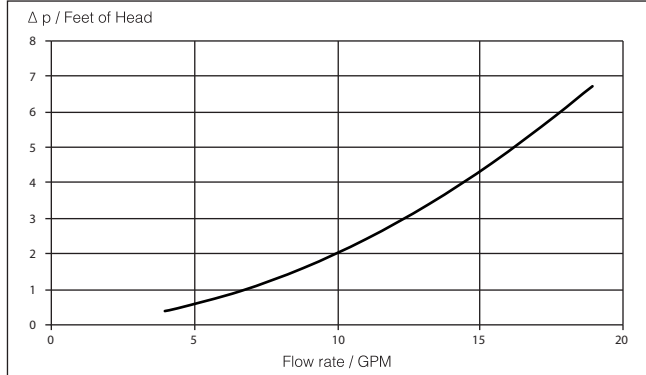

**SSB399**

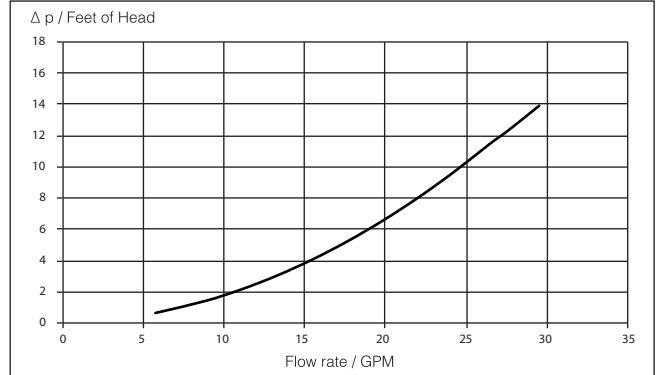

**SSB512**

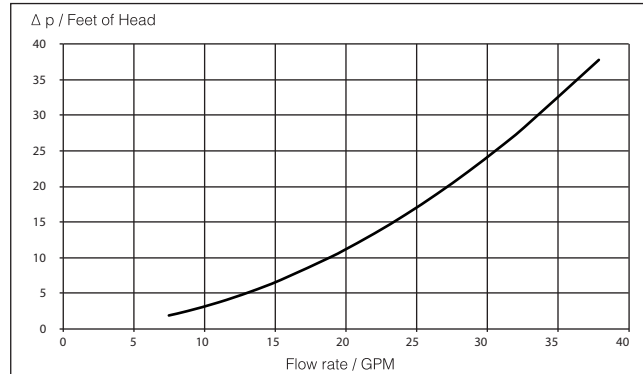

**Boiler Clearances**

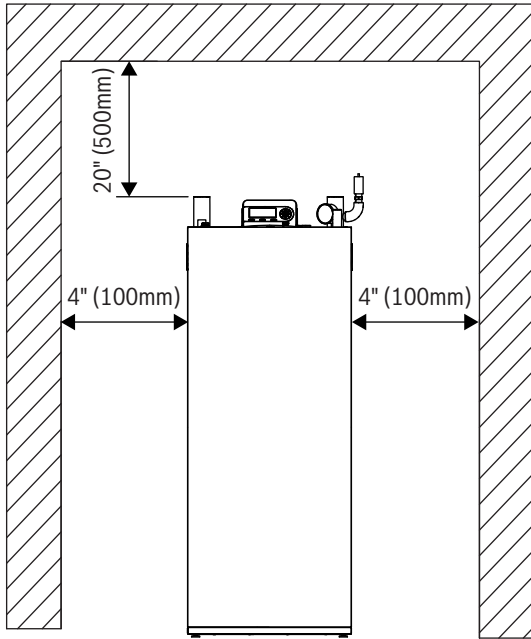

Front View

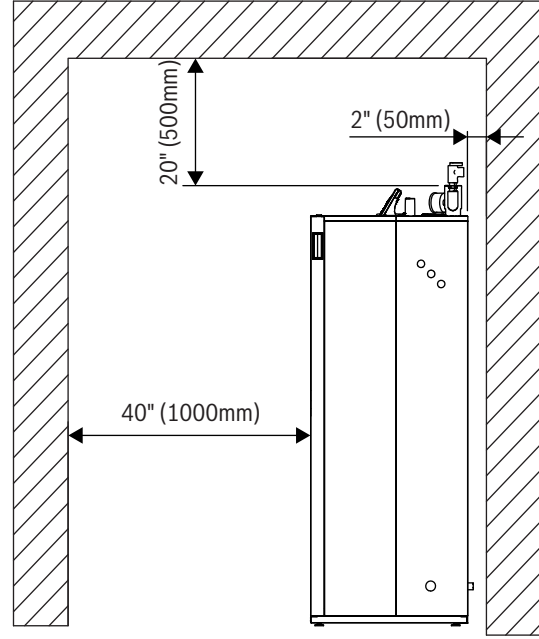

Side View

\* NOTE: 2" (50.8 mm) clearance from combustibles is per CSA certifications, but respect the clearance listed above for serviceability.  
The boiler can be installed on a combustible (wood) floor excluding carpets.

**DISCLAIMER**

Specifications subject to change without notice. All dimensions shown on these engineering submittal sheets are for reference only and should not be used for field installation purposes. Please refer to current product installation manuals for detailed installation instructions and dimensions.