



THBF721 Master Series  
**INSTALLATION MANUAL**

# INSTALLATION MANUAL

This manual covers the following models:

- **THBF721**

## Thermostat Applications Guide

| Description                               |     |
|---|-----|
| Gas or Oil Heat                           | Yes |
| Electric Furnace                          | Yes |
| Heat Pump (No Aux. or Emergency Heat)     | Yes |
| Heat Pump (With Aux. or Emergency Heat)   | Yes |
| Multi-Stage Systems                       | Yes |
| Heat Only Systems                         | Yes |
| Heat Only Systems - Floor or Wall Furnace | Yes |
| Cool Only Systems                         | Yes |
| Millivolt Conventional Systems            | Yes |
| Two Transformer Systems                   | No  |

## Table of Contents

## Page

|                                   |         |
|-----------------------------------|---------|
| Installation Tips                 | 2       |
| Thermostat Quick Reference        | 3       |
| Subbase Installation              | 4       |
| Wiring                            | 5 - 12  |
| Technician Setup Menu             | 13 - 16 |
| Mounting and Battery Installation | 17      |
| Programming the Thermostat        | 18      |
| Specifications                    | 18      |

## Power Type

Battery Power

Hardwire (Common Wire)

Hardwire (Common Wire) with Battery Backup

**This product must be installed by a trained, experienced technician.**

Failure to carefully follow these instructions could create hazardous conditions or cause damage to the product.

## Wall locations

The thermostat should be installed approximately 4 to 5 feet above the floor. Select an area with average temperature and good air circulation.

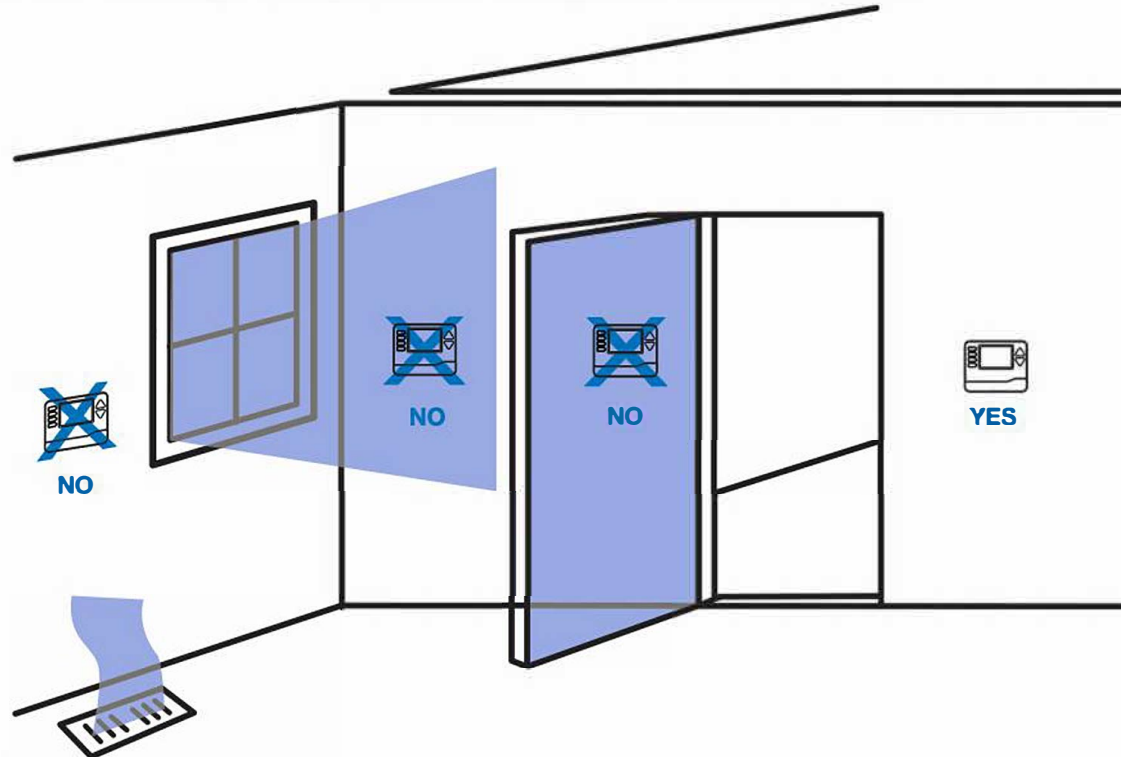

### Do not install thermostat:

- Near hot or cold air ducts
- In direct sunlight
- On an outside adjacent wall
- In areas that do not require conditioning
- Near dead spots or drafts (in corners or behind doors)
- Near concealed chimneys or pipes

### Tip

Pick an installation location that is easy for the user to access. The temperature of the location should be representative of the building.

# THERMOSTAT QUICK REFERENCE

## Getting to know your thermostat

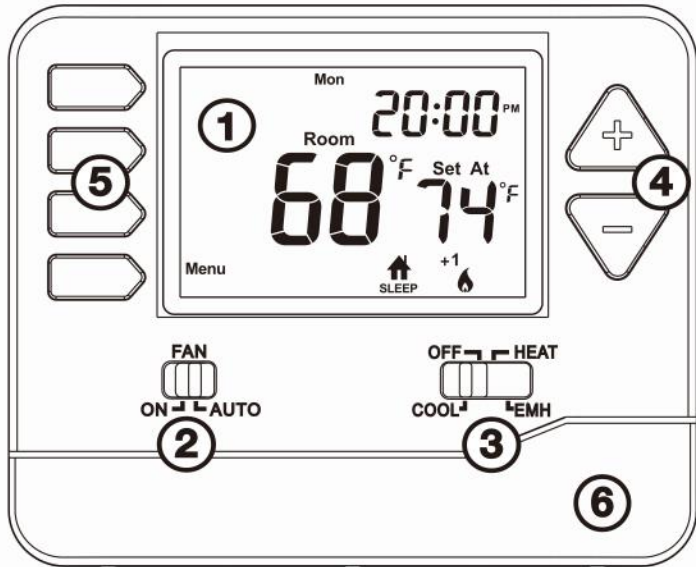

- ① LCD Display
- ② Fan Switch
- ③ System Switch
- ④ Temperature Setpoint Buttons
- ⑤ User Buttons
- ⑥ Easy Change Battery Door

### ① LCD

Days of the week and time.

Displays the user selected setpoint temperature.

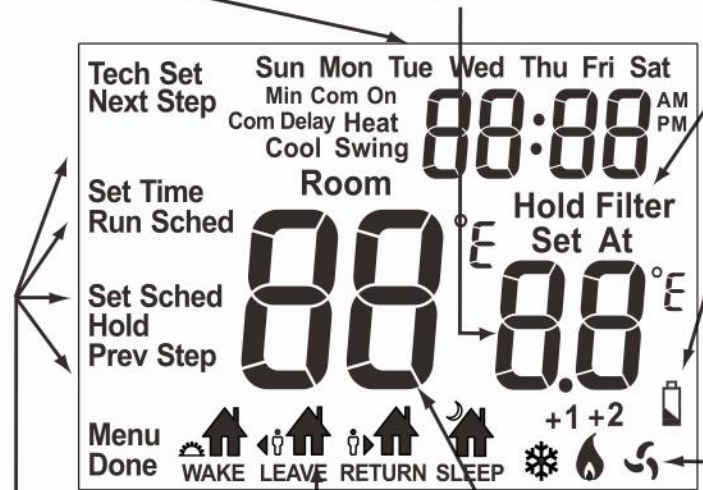

Button Options

**Programmable Time Periods:**  
This thermostat has 4 programmable time periods per day.

Indicates the current room temperature.

**Hold:** Is displayed when thermostat program is permanently overridden.

**Low Battery Indicator:**  
Replace batteries when indicator is shown.

**System Operation Indicators:**

The ❄️ 🔥 or 🌀 icon will display when the COOL, HEAT, or 🌀 (fan) is on.

**NOTE:** The compressor delay feature is active if these icons are flashing. The compressor will not turn on until the 5 minute delay has elapsed.

# SUBBASE INSTALLATION



### Caution: Electrical Hazard

Failure to disconnect the power before beginning to install this product can cause electrical shock or equipment damage.



### Mercury Notice:

All of our products are mercury free. However, if the product you are replacing contains mercury, dispose of it properly. Your local waste management authority can give you instructions on recycling and proper disposal.

For a vertical mount put one screw top and one screw bottom.

For a horizontal mount put one screw left and one screw right.

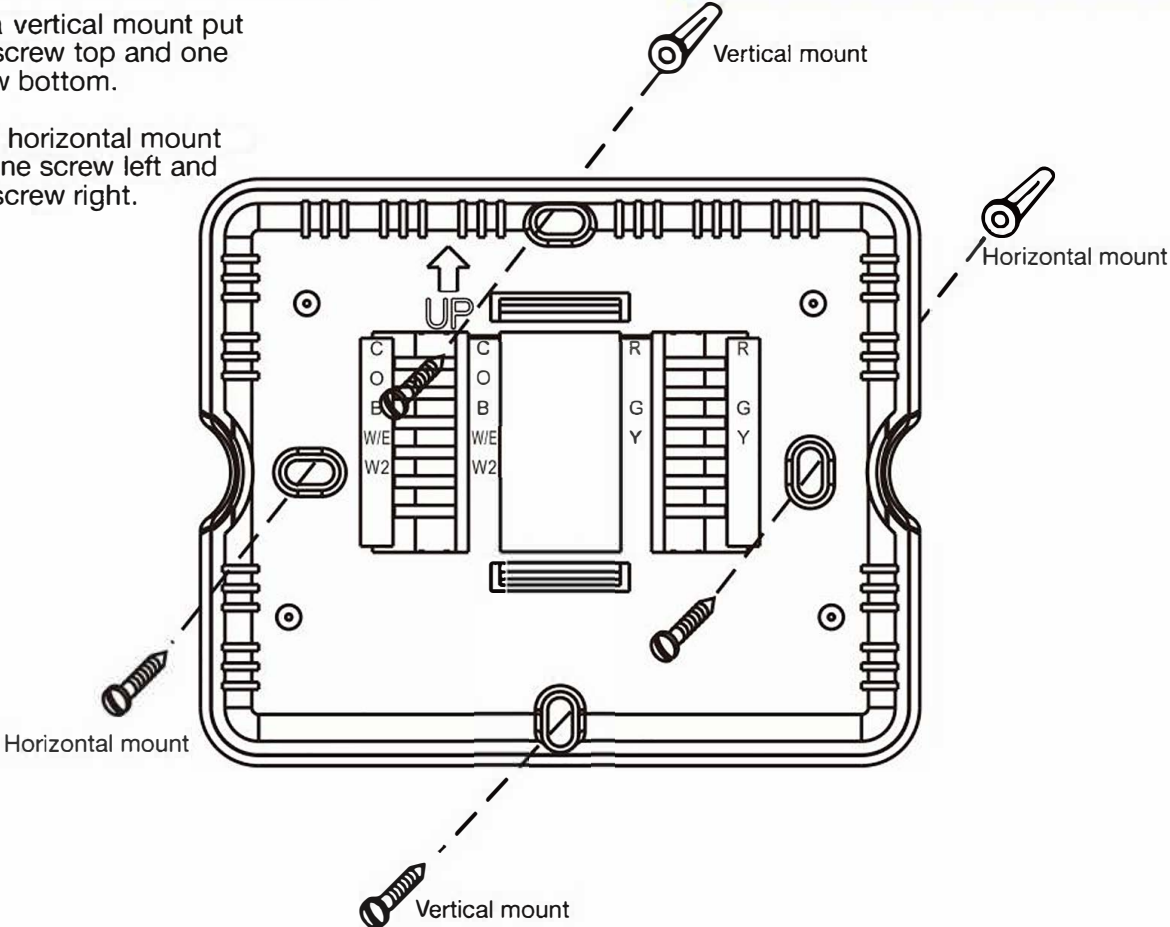

# WIRING

## 1 Turn off Power to Heating/Cooling System

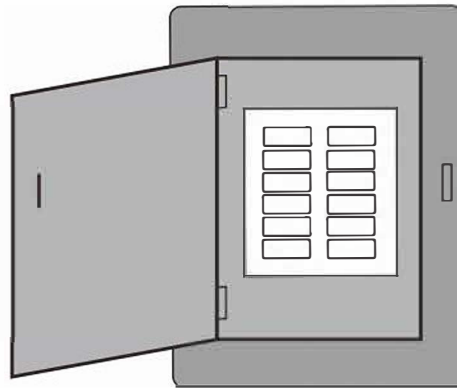

Circuit breaker  
box

or

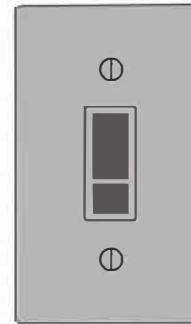

Heating/cooling system  
power switch

## 2 Remove Old Thermostat

Remove the old thermostat but leave the wallplate with wires attached. Do not remove the wallplate yet.

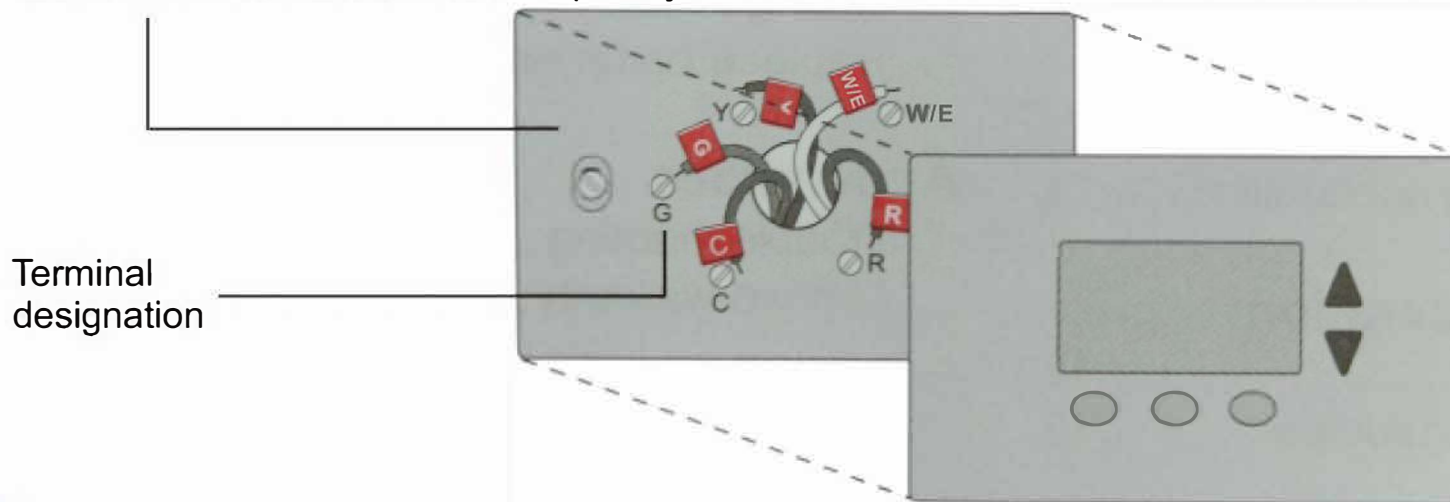

## 3 Label Wires with Tags

Label the wires using the supplied wire labels as you disconnect them.

| Wiring Labels   |      | Étiquettes de fils   |    | Rótulos para los cables   |    |     |     |    |    |
|---|------|--|----|---|----|-----|-----|----|----|
| Apply these wiring labels to each wire with the appropriate terminal designation as you remove it from the existing thermostat. |      | Lorsque vous retirez les fils des bornes du thermostat existant, collez ces étiquettes sur chaque fil correspondant à la lettre de la borne. |    | Coloque estos rótulos, con la designación de las terminales, en cada cable al remover los cables del termostato actual. |    |     |     |    |    |
| B   | B    | Y2   | Y2 | C   | C  | W/E | W/E | F  | F  |
| G   | G    | H  | H  | L   | L  | O   | O   | P  | P  |
| R   | R    | RC   | RC | RH  | RH | T   | T   | U  | U  |
| V/VR  | V/VR | W  | W  | W1  | W1 | W2  | W2  | W3 | W3 |
| X   | X    | X1   | X1 | X2  | X2 | Y   | Y   | Y1 | Y1 |
| AUX   | AUX  |  |    |   |    |     |     |    |    |

Wire Labels

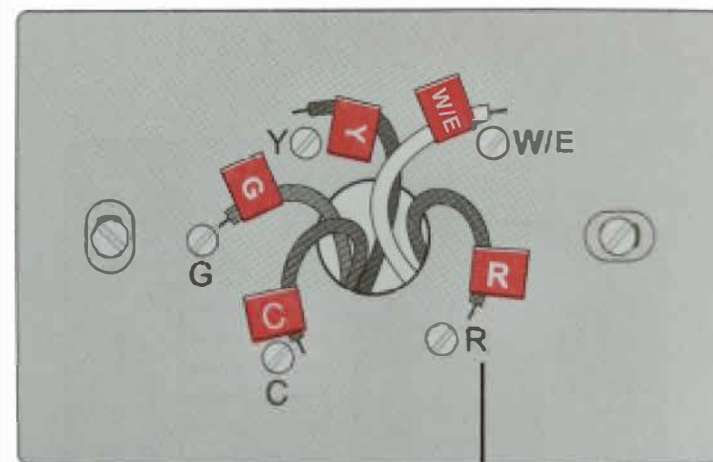

Terminal designation

## 4 Separate Wallplate from New Thermostat

Remove the wallplate from the new thermostat and mount onto the wall.

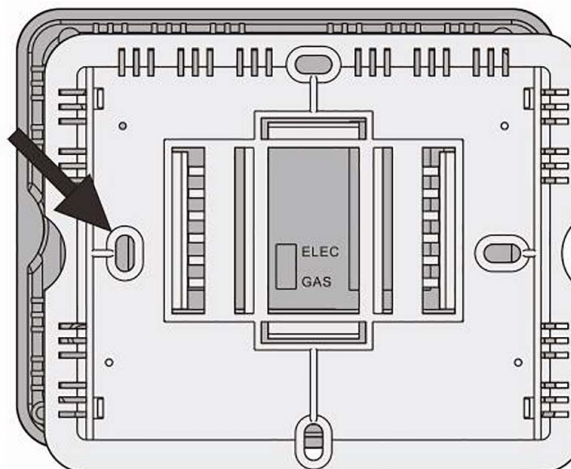

Wallplate

# WIRING

## 5 Mount New Wallplate

Mount the new wallplate using the included screws and anchors.

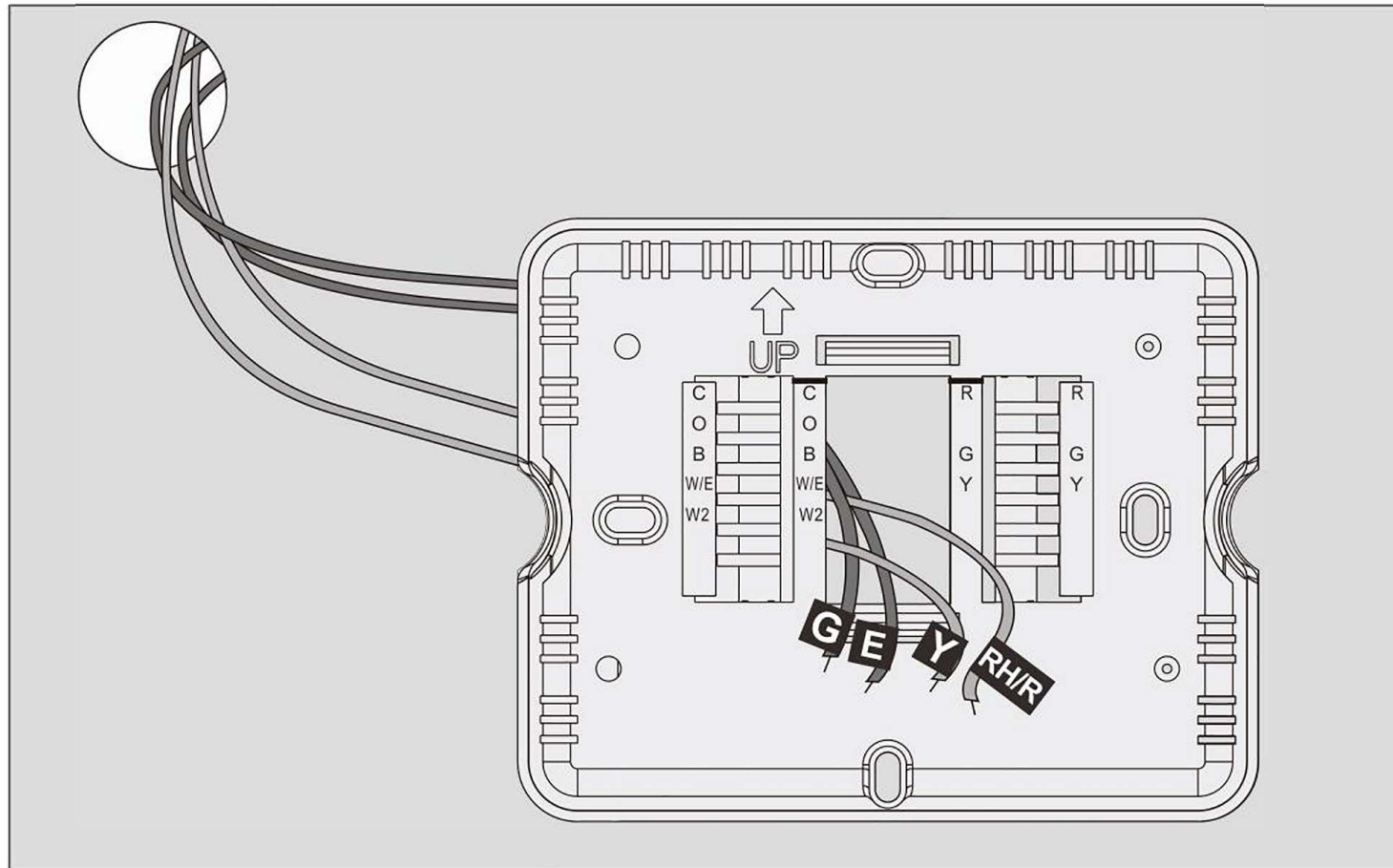

Drill 3/16-in. holes for drywall  
Drill 3/16-in. holes for plaster

6 Connect Wires

Match the wire labels.

If the labels do not match the letters on the thermostat, refer to "Alternate Wiring (Conventional Systems)" on page 9 and connect the terminal accordingly (see notes below).

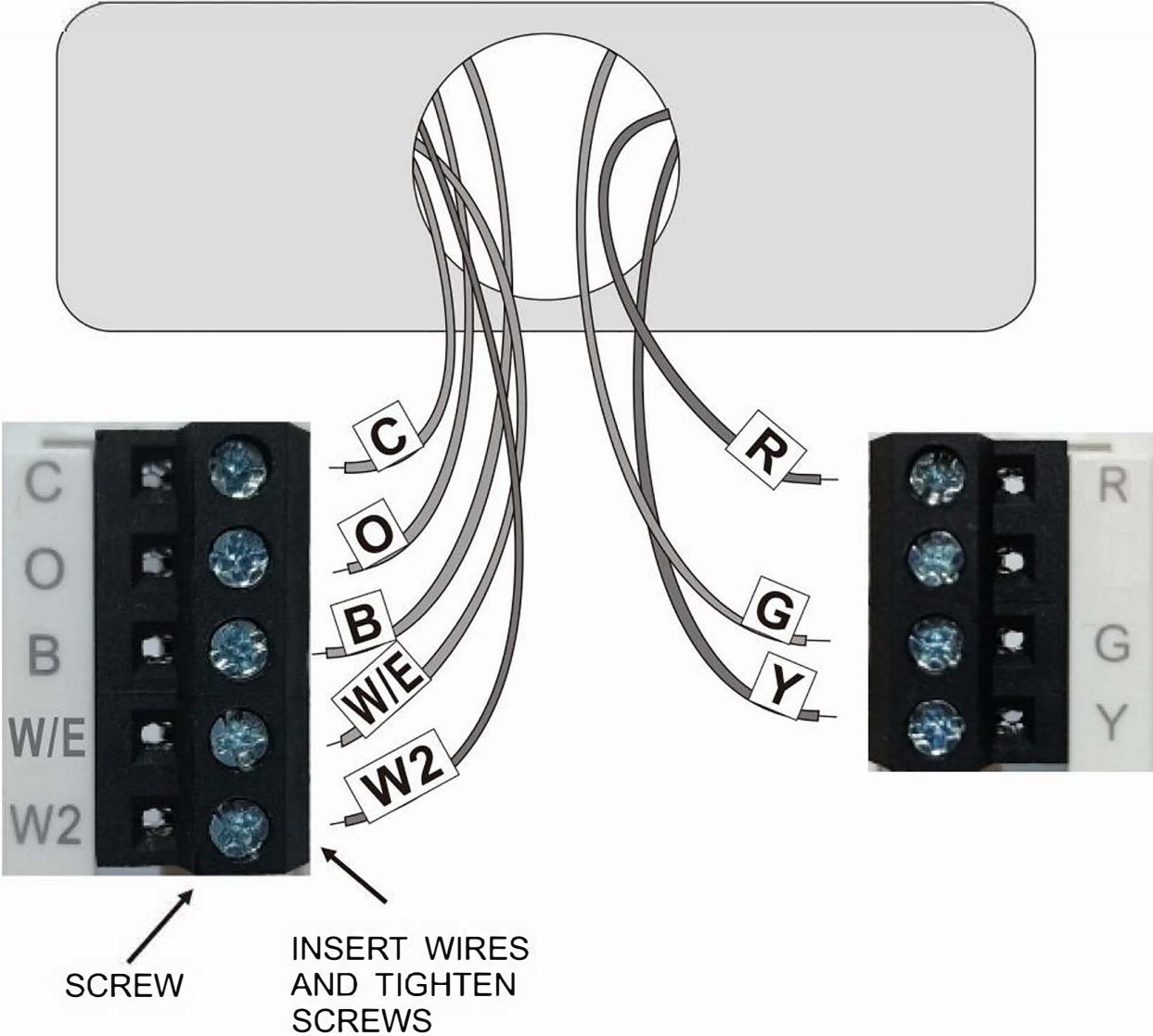

# WIRING

## Alternate Wiring (Conventional Systems)

If the labels do not match letters on the thermostat, refer to the chart below and connect the terminal accordingly (see notes below).

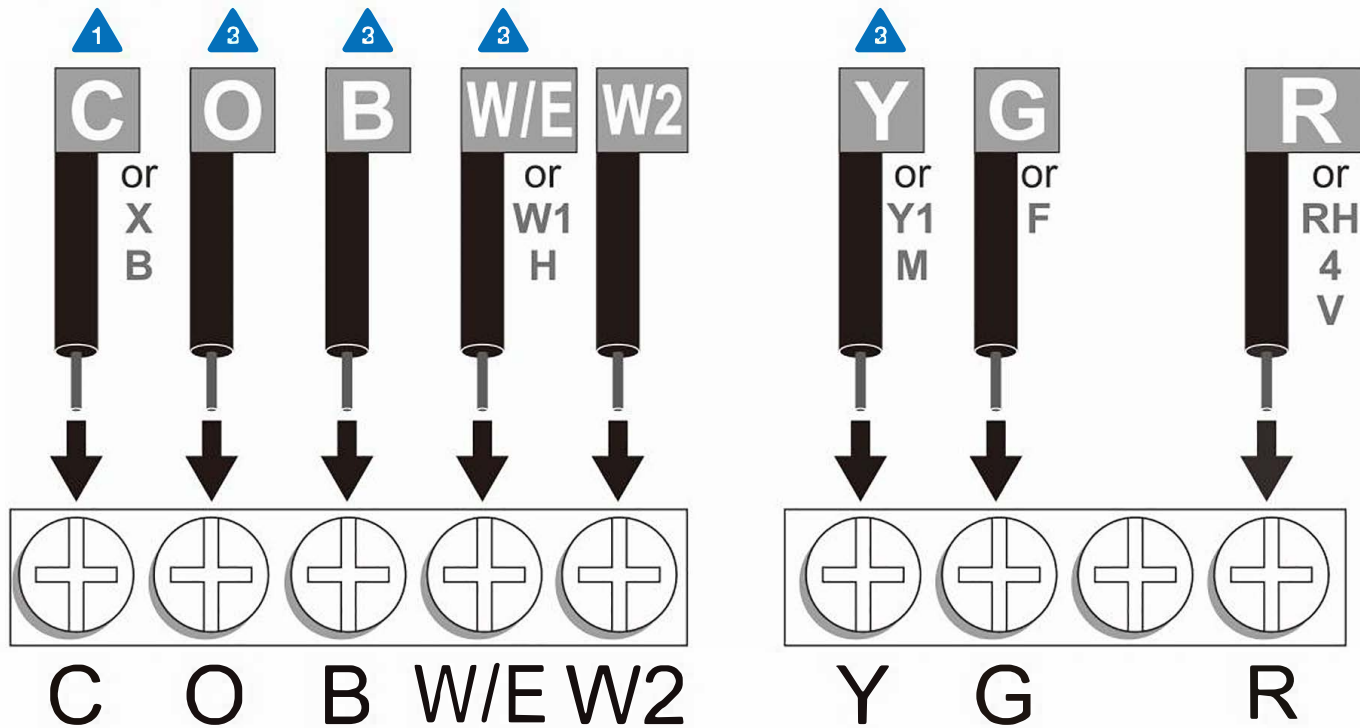

- 1** If a C or X wire is available, connect with the C terminal. If there is no C or X wire, there is no need to connect with C terminal.
- 2** If you have a heat pump without auxiliary/backup, connect O OR B. Do not connect both. If you do not have a heat pump, do not connect B. Wrap bare end of wire with electrical tape.
- 2** Place a jumper (piece of wire) between Y and W if you are using a heat pump without auxiliary/backup heat.



## Caution: Electrical Hazard

Failure to disconnect the power before beginning to install this product can cause electrical shock or equipment damage.



## Warning:

All components of the control system and the thermostat installation must conform to Class II circuits per the NEC Code.

### Wiring

1. If you are replacing a thermostat, make note of the terminal connections on the thermostat that is being replaced. In some cases the wiring connections will not be color coded. For example, the green wire may not be connected to the **G** terminal.
2. Loosen the terminal block screws. Insert wires then retighten terminal block screws.
3. Place nonflammable insulation into wall opening to prevent drafts.

### Terminal Designations

|            | Heat Pump System<br>1 HEAT 1 COOL / 2 HEAT 1 COOL | Conventional System<br>1 HEAT 1 COOL / 2 HEAT 1 COOL |
|------------|---|--|
| <b>R</b>   | Transformer Power                                 | Transformer Power                                    |
| <b>C</b>   | Transformer Common                                | Transformer Common                                   |
| <b>B</b>   | Changeover Valve Energized in HEAT                | Energized in HEAT                                    |
| <b>O</b>   | Changeover Valve Energized in COOL                | Energized in COOL                                    |
| <b>G</b>   | Fan Relay   | Fan Relay  |
| <b>W/E</b> | First Stage of Emergency HEAT                     | First Stage of HEAT                                  |
| <b>W2</b>  | Second Stage of HEAT/<br>EMERGENCY HEAT           | Second Stage of HEAT                                 |
| <b>Y</b>   | First Stage of HEAT and COOL                      | First Stage of COOL                                  |

### Installation Tip:

Do not overtighten terminal block screws as this can damage the terminal block. A damaged terminal block can keep the thermostat from fitting on the subbase correctly or cause system operation issues. Max Torque = 6in-lbs.



## Typical 2H/1C Heat Pump System with separate emergency heat

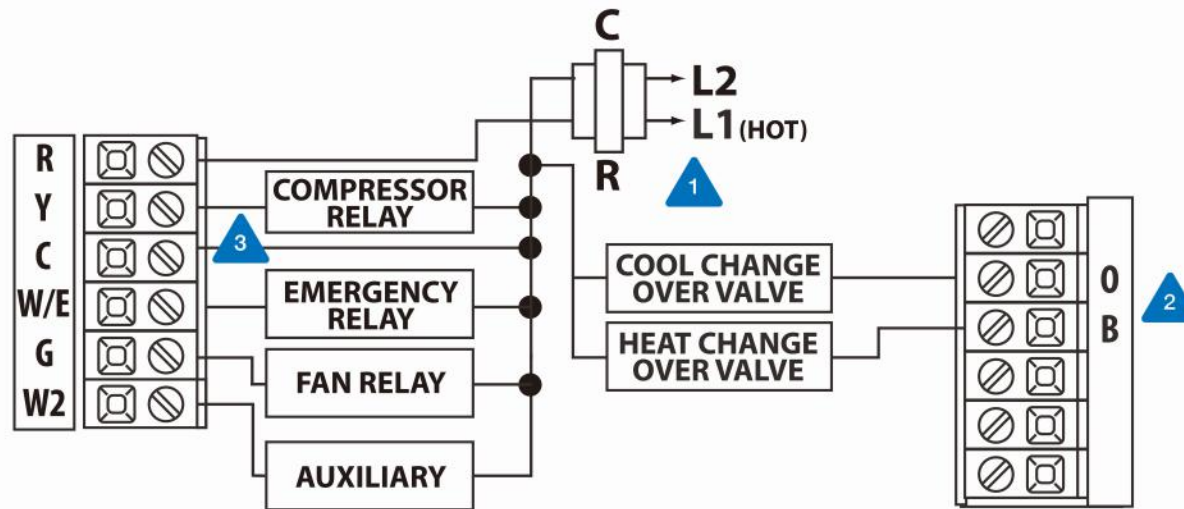

## Conventional System 1H/1C, 2H/1C

(Heat pump set to "OFF" in tech settings)

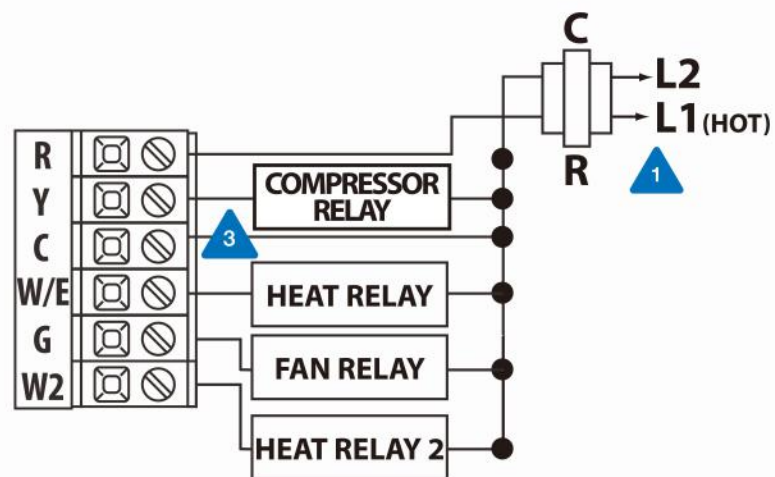

**Note:** This thermostat is only compatible with ONE transformer systems.



# TECHNICIAN SETUP MENU

## Technician Setup Menu

---



This thermostat has a technician setup menu for easy installer configuration. To setup the thermostat for your particular application:

1. Press **MENU** button
2. Press and hold **TECH SET** button for 3 seconds. This 3 second delay is designed so that homeowners do not accidentally access the installer settings.
3. Configure the installer options as desired using the table below.



Use the  or  keys to change settings and the **NEXT STEP** or **PREV STEP** key to move from one option to another. **Note:** Only press **DONE** key when you want to exit the Technician Setup options.

4. °F/°C Selection: F(Fahrenheit) or C(Celsius).
5. 24H/12H Selection : 24 hour or 12 hour time format.
6. ELEC/GAS Selection : Select the ELEC or GAS.



# TECHNICIAN SETUP MENU

| Feature                                    | Feature Description   | LCD will show   | Adjustment Options   | Factory default settings |
|--|---|---|--|--------------------------|
| <p><b>Filter Change Reminder</b></p>       | <p>This feature will flash “FILT” in the display after the elapsed run time to remind the user to change the filter. A setting of “off” will disable this feature.</p>  |   | <p>You can adjust the filter change reminder from “off” to 2000 hours of runtime in 50 hour increments.</p>  | <p>OFF</p>               |
| <p><b>Room Temperature Calibration</b></p> | <p>This feature allows the installer to change the calibration of the room temperature display. For example, if the thermostat reads 70°F and you would like it to read 72°F then select +2.</p>  |   | <p>You can adjust the room temperature display to read -3°F to 3°F above or below the factory calibrated reading.</p>  | <p>0°F</p>               |
| <p><b>Minimum Compressor On Time</b></p>   | <p>This feature allows the installer to select the minimum run time for the compressor. For example: A setting of 4 will force the compressor to run for at least 4 minutes every time the compressor turns on, regardless of the room temperature.</p> |  | <p>You can select the minimum compressor run time from “off”, “3”, “4”, or “5” minutes. If 3,4, or 5 is selected, the compressor will run for at least the selected time before turning off.</p> | <p>OFF</p>               |

# Technician Setup Menu

| Feature                                    | Feature Description   | LCD will show  | Adjustment Options   | Factory default settings |
|--|---|--|--|--------------------------|
| <p><b>Compressor Short Cycle Delay</b></p> | <p>The compressor short cycle delay protects the compressor from “short cycling”. this feature will not allow the compressor to be turned on for 5 minutes after it was last turned off.</p>                      |    | <p>Selecting “ON” will not allow the compressor to be turned on for 5 minutes after the last time the compressor was on. Select “OFF” to remove this delay.</p>  | <p>0n</p>                |
| <p><b>Cooling Swing</b></p>                | <p>The swing setting, often called “cycle rate”, “differential” or “anticipation”, is adjustable. A smaller swing setting will cause more frequent cycles and a larger swing setting will cause fewer cycles.</p> |    | <p>The cooling swing setting is adjustable from ± 0.2°F to ± 2°F. For example: A swing setting of 0.5°F will turn the cooling on at approximately 0.5°F above the setpoint and turn the cooling off at approximately 0.5°F below the setpoint.</p> | <p>0.5°F</p>             |
| <p><b>Heating Swing</b></p>                | <p>The swing setting, often called “cycle rate”, “differential” or “anticipation”, is adjustable. A smaller swing setting will cause more frequent cycles and a larger swing setting will cause fewer cycles.</p> |  | <p>The heating swing setting is adjustable from ± 0.2°F to ± 2°F. For example: A swing setting of 0.5°F will turn the heating on at approximately 0.5°F below the setpoint and turn the heating off at approximately 0.5°F above the setpoint.</p> | <p>0.4°F</p>             |

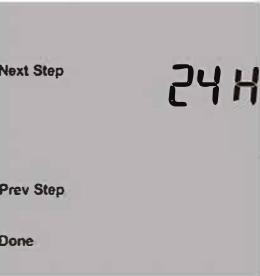
# Technician Setup Menu

| Tech Settings              |  | LCD Will Show   | Adjustment Options                                | Default              |
|----------------------------|--|---|---|----------------------|
| <b>F or C</b>              | Select F for Fahrenheit temperature read out, or select C for Celsius temperature read out.  |   | F for Fahrenheit C for Celsius                    | 0F                   |
| <b>12 or 24 Hour Clock</b> | You can Select either a 12 or 24 hour clock setting.   |   | Use the + or - key to select 12 or 24 hour clock. | <b>12 Hour Clock</b> |
| <b>Fan Operation</b>       | Select GAS for systems that control the fan during a call for heat. Select ELEC to generate the fan when the fan relay is connected to the G terminal. |  | GAS or ELEC                                       | 9 AS                 |

## Tip

Temperature swing, sometimes called "differential" or "cycle rate", can be customized for individual applications. For most applications, choose a swing setting that is as long as possible without making the occupants uncomfortable.

# MOUNT THERMOSTAT & BATTERY INSTALLATION

## Mount Thermostat

Align the 4 tabs on the subbase with corresponding slots on the back of the thermostat, then push gently until the thermostat snaps in place.

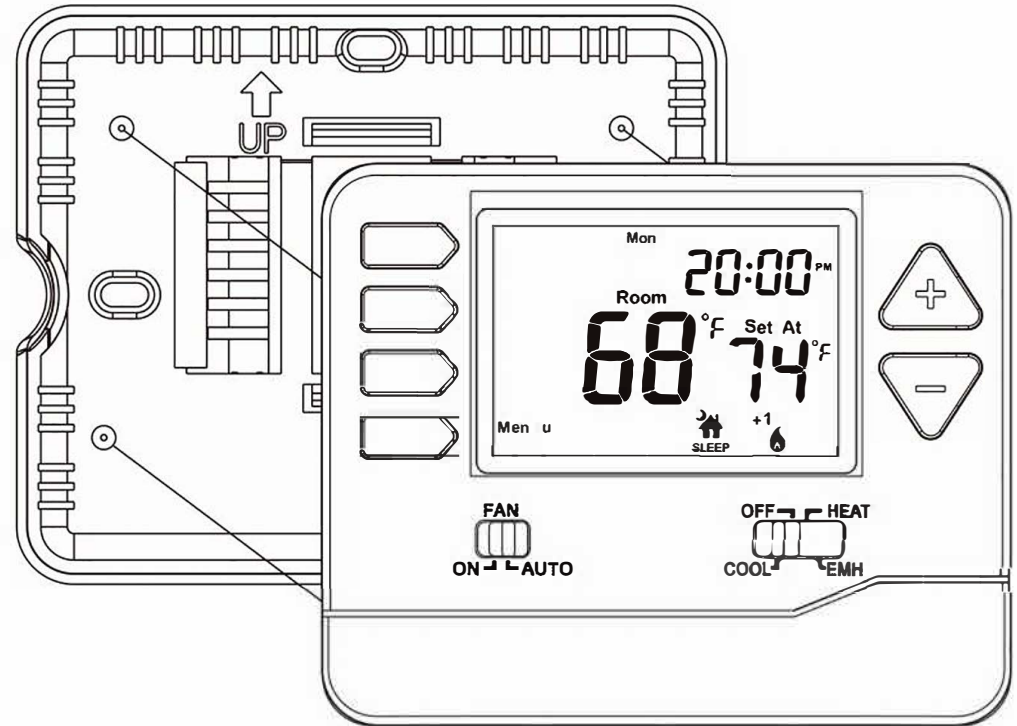

## Battery Installation

Battery installation is optional if thermostat is hardwired (**C** terminal connected).

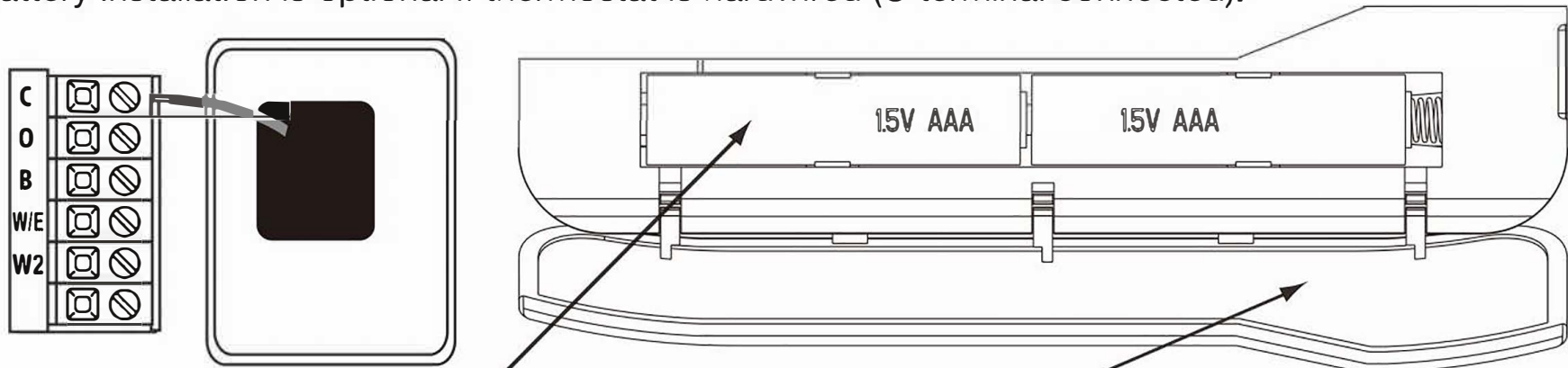

17







Insert 2 AAA alkaline batteries.

Operating instructions can be found on the back of the battery door.

# PROGRAMMING THE THERMOSTAT

## Set Time

Follow the steps below to set the day of the week and current time:

1. Press **MENU**
2. Press **SET TIME**
3. Day of the week will be flashing. Use the  or  key to select the current day of the week.
4. Press **NEXT STEP**
5. The current hour will be flashing. Use the  or  keys to select a.m. or p.m. the current hour.
6. Press **NEXT STEP**
7. Minutes will be flashing. Use the  or  key to select the current minutes.
8. Press **DONE** when completed

## SPECIFICATIONS & CONTACT INFORMATION

### Specifications

|  |  |
|--|--|
| The display range of temperature . . . . .   | 41°F to 95°F (5°C to 35°C)   |
| The control range of temperature . . . . .   | 44°F to 90°F (7°C to 32°C)   |
| Load rating . . . . .                        | 1 amp per terminal, 1.5 amp maximum all terminals combined   |
| Display accuracy . . . . .                   | ± 1°F  |
| Swing (cycle rate or differential) . . . . . | Heating is adjustable from 0.2°F to 2.0°F<br>Cooling is adjustable from 0.2°F to 2.0°F                                   |
| Power source . . . . .                       | 18 to 30 VAC, NEC Class II, 50/60 Hz for hardwire (common wire)<br>Battery power from 2 AAA Alkaline Energizer batteries |
| Operating ambient . . . . .                  | 32° to +105° (0° to +41°C)   |
| Operating humidity . . . . .                 | 90% non-condensing maximum   |
| Dimensions of thermostat . . . . .           | 4.72"W x 3.86"H x 0.98"D   |