

SKU: IFTH150

1-1/2" Threaded (NPT) Isolation Flange w/ Hose Drain

Applications:

Ideal for HVAC pump connections in hydronic heating and chilled water systems, this isolator flange simplifies circulator pump installation and service. It is well suited for boiler piping and cooling tower systems where reliable shutoff and service isolation are required, as well as for mechanical equipment isolation to allow maintenance without draining the entire system.

Specifications:

- **Pressure Rating:** 600 WOG
- **Design:** Blowout-proof stem with adjustable packing gland
- **Inlet:** Tapered flange inlet to minimize turbulence
- **Port Type:** Full Port
- **Drain Thread Type:** 3/4" GH
- **Drain:** Flat-head operated drain valve
- **Thread Standard:** ANSI B1.20.1

Materials:

- **Body:** C46500 LF Brass
- **Ball:** Brass, chrome plated
- **Stem Seal:** PTFE
- **Lever Handle:** Steel, chrome plated
- **Flange Bolts & Nuts:** Steel, zinc plated

Certifications/Listings/Approvals

- ANSI/ASME B1.20.1
- ASME A112.4.14-2024
- MSS SP-110
- ANSI Z1157-2014
- FM Approved
- NSF -61
- NSF-372
- cUPC



Certified to
NSF/ANSI 61
& 372



CHOOSE THE RIGHT FLANGE

STANDARD VS HIGH VELOCITY (HV)

STANDARD

ITEM #



- 12 1/2" ROUND HOLES
- FITS STANDARD CIRCULATOR PUMPS ONLY
- BEST FOR TYPICAL RESIDENTIAL SYSTEMS

HIGH VELOCITY (HV)

HV ITEM #



- 5/8" SLOTTED HOLES
- FITS STANDARD & HIGH-VELOCITY PUMPS
- IDEAL FOR MODERN ECM / VARIABLE-SPEED SYSTEMS

Product Offerings and Dimensions

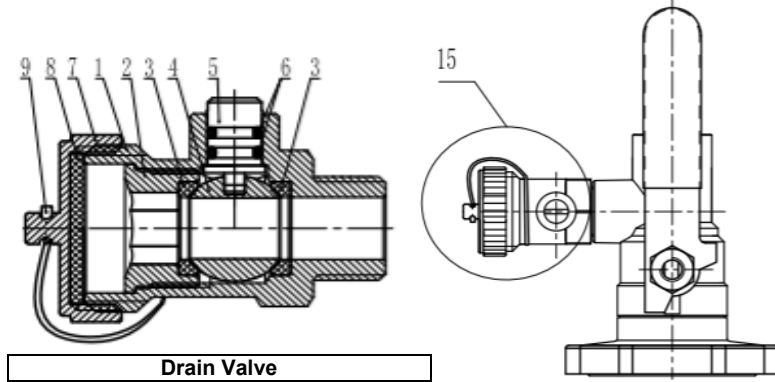
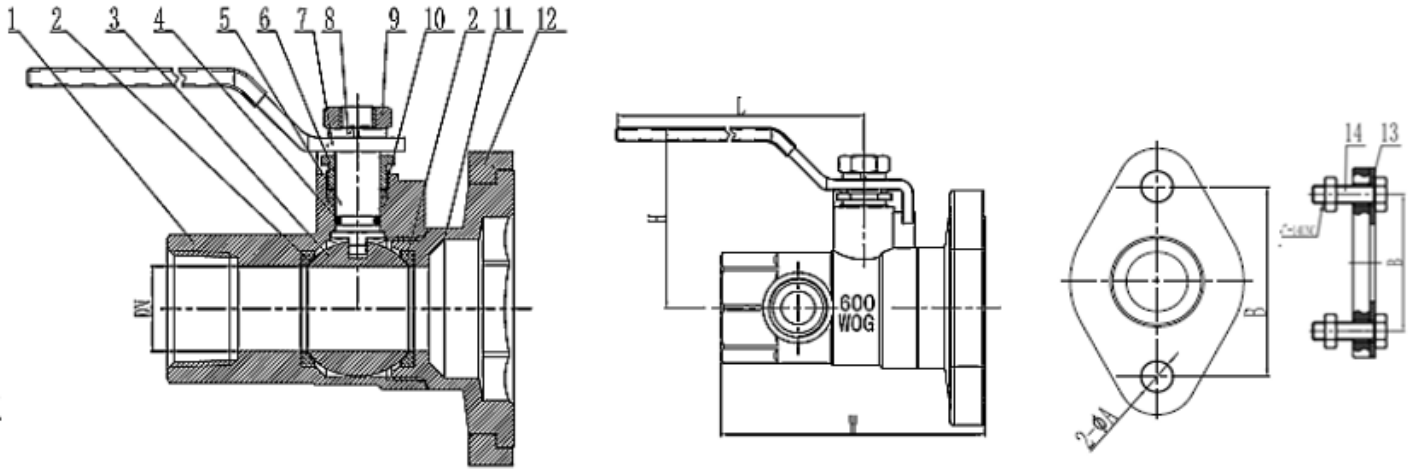

Drain Valve			
No	Item	Total	Material
1	Body	1	Brass
2	Cap	1	Brass
3	Seat	1	PTFE
4	Ball	1	Brass (Chrome Plated)
5	Stem	1	Brass
6	O-Ring	1	NBR
7	Cap Nut		Brass
8	Washer	1	EPDN
9	Chain	1	PVC

No.	Item	Total	Material
1	Body	1	Brass
2	Seat	2	Plated Steel
3	Ball	1	Stainless Steel (3/4" - 1) Brass/Chrome Plated (1-1/4" - 2")
4	O-Ring	1	NBR
5	Stem	1	Brass
6	Packing Kit	1	Brass
7	Handle	1	Plated Steel
8	Lock Washer	1	Plated Steel
9	Handle Nut	1	Plated Steel
10	Packing	1	PTFE
11	Cap	1	Brass
12	Flange Cap	1	Brass
13	Rubber Washer	1	EPDM
14	Bolt/Nut	2	Plated Steel
15	Drain Valve	1	Brass

SKU	SIZE	DN / IN	W / IN	H / IN	L / IN	A / IN	B / IN
IFTH075	3/4"	0.75	3.105	2.11	3.47	0.50	3.12
IFTH100	1"	0.98	3.27	2.25	4.29	0.50	3.12
IFTH125	1-1/4"	1.24	3.81	2.49	5.63	0.50	3.12
IFTH150	1-1/2"	1.46	4.24	2.66	5.63	0.50	3.50