

BALDOR® • RELIANCE 

Product Information Packet

EM3611T-G

3HP,1760RPM,3PH,60HZ,182T,3632M,TEFC,F1

Part Detail							
Revision:	T	Status:	PRD/A	Change #:		Proprietary:	No
Type:	AC	Elec. Spec:	36WGS266	CD Diagram:	CD0005	Mfg Plant:	
Mech. Spec:	36M524	Layout:	36LYM524	Poles:	04	Created Date:	09-27-2010
Base:	RG	Eff. Date:	12-07-2020	Leads:	9#16		

Specs			
Catalog Number:	EM3611T-G	Heater Indicator:	No Heater
Enclosure:	TEFC	Insulation Class:	H
Frame:	182T	Inverter Code:	Inverter Ready
Frame Material:	Steel	KVA Code:	K
Output @ Frequency:	3.000 HP @ 60 HZ	Lifting Lugs:	No Lifting Lugs
Synchronous Speed @ Frequency:	1800 RPM @ 60 HZ	Locked Bearing Indicator:	Locked Bearing
Voltage @ Frequency:	460.0 V @ 60 HZ	Motor Lead Quantity/Wire Size:	9 @ 16 AWG
	230.0 V @ 60 HZ	Motor Lead Exit:	Ko Box
XP Class and Group:	None	Motor Lead Termination:	Flying Leads
XP Division:	Not Applicable	Motor Type:	3632M
Agency Approvals:	UR	Mounting Arrangement:	F1
	CSA EEV	Power Factor:	75
	CSA	Product Family:	General Purpose
Auxillary Box:	No Auxillary Box	Pulley End Bearing Type:	Ball
Auxillary Box Lead Termination:	None	Pulley Face Code:	Standard
Base Indicator:	Rigid	Pulley Shaft Indicator:	Standard
Bearing Grease Type:	Polyrex EM (-20F +300F)	Rodent Screen:	None
Blower:	None	Shaft Extension Location:	Pulley End

Current @ Voltage:	4.200 A @ 460.0 V	Shaft Ground Indicator:	Shaft Grounding
	8.400 A @ 230.0 V	Shaft Rotation:	Reversible
	9.000 A @ 208.0 V	Shaft Slinger Indicator:	No Slinger
Design Code:	B	Speed Code:	Single Speed
Drip Cover:	No Drip Cover	Motor Standards:	NEMA
Duty Rating:	CONT	Starting Method:	Direct on line
Electrically Isolated Bearing:	Not Electrically Isolated	Thermal Device - Bearing:	None
Feedback Device:	NO FEEDBACK	Thermal Device - Winding:	None
Front Face Code:	Standard	Vibration Sensor Indicator:	No Vibration Sensor
Front Shaft Indicator:	None	Winding Thermal 1:	None
		Winding Thermal 2:	None

Nameplate NP3441LUA										
CAT.NO.	EM3611T-G									
SPEC	36M524S266G1									
HP	3									
VOLTS	230/460									
AMPS	8.4/4.2									
RPM	1760									
FRAME	182T				HZ	60			PH	3
SF	1.15		CODE	K	DES	B		CLASS	H	
NEMA NOM. EFF	89.5		PF	75						
RATING	40C AMB-CONT									
CC	010A				USABLE AT 208V					9
ENCL	TEFC		SER							
DE	6206			ODE	6205					
VPWM INVERTER READY										
CT6-60H(10:1)VT3-60H(20:1)										
									50Hz 3HP 190/380V 9.6/4.8A	
									SF1.0	

Parts List		
Part Number	Description	Quantity
SA203657	SA 36M524S266G1	1.000 EA
RA190917	RA 36M524S266G1	1.000 EA
36FN3000C01SP	EXFN, PLASTIC, 5.25 OD, .912 ID	1.000 EA
36CB3004	36 CB CASTING W/1.09 DIA LEAD HOLE @ 6:0	1.000 EA
36GS1000SP	GASKET-CONDUIT BOX, .06 THICK #SV-330 LE	1.000 EA
51XB1016A08	10-16X 1/2HXWSSLD SERTYB	2.000 EA
11XW1032G06	10-32 X .38, TAPTITE II, HEX WSHR SLTD U	1.000 EA
36EP3104A01	FREP MACH ASSEMBLY FOR ROUTING	1.000 EA
HW4500A01	1641B(ALEMITE)400 UNIV, GREASE FITT	1.000 EA
HW5100A05	WVY WSHR F/205 & 304 BRGS	1.000 EA
36EP3100A56	ENDPLATE, MACH	1.000 EA
10XN2520A24	1/4-20X 1 1/2 HEX HD X	2.000 EA
HW1001A25	LOCKWASHER 1/4, ZINC PLT .493 OD, .255 I	2.000 EA
HW4500A01	1641B(ALEMITE)400 UNIV, GREASE FITT	1.000 EA
XY2520A12	1/4-20 HEX NUT, DIRECTIONAL SERRATIONS	4.000 EA
36FH4009A102	IEC FH GREASER PRIMED	1.000 EA
51XW1032A06	10-32 X .38, TAPTITE II, HEX WSHR SLTD S	3.000 EA
36CB4516	750LIPPED CB LID - GALVANNEAL	1.000 EA
37GS1001	GASKET, CONDUIT BOX LID, .06 THICK LEXID	1.000 EA
51XW0832A07	8-32 X .44, TAPTITE II, HEX WSHR SLTD SE	4.000 EA
HW2501E16	KEY, 1/4 SQ X 1.750	1.000 EA
HA7000A02	KEY RETAINER RING, 1 1/8 DIA, 1 3/8 DIA	1.000 EA
85XU0407S04	4X1/4 U DRIVE PIN STAINLESS	2.000 EA
LB1459	AEGIS SGR LABEL "AEGISLBL-100"	1.000 EA

Parts List (continued)		
Part Number	Description	Quantity
MJ1000A02	GREASE, MOBIL POLYREX EM - 124047	0.050 LB
51XB1214A16	12-14X1.00 HXWSSLD SERTYB	1.000 EA
MG1000Y03	MUNSELL 2.53Y 6.70/ 4.60, GLOSS 20,	0.022 GA
HA3101A25	THRUBOLT 1/4-20 X 11.000 OHIO ROD	4.000 EA
LC0005E01	CONN.DIA./WARNING LABEL (LC0005/LB1119N)	1.000 EA
NP3441LUA	ALUM SUPER-E VPWM INV READY UL CSA-EEV C	1.000 EA
36PA1001	PKG GRP, PRINT PK1017A06	1.000 EA
MN416A01	TAG-INSTAL-MAINT no wire (2100/bx) 4/22	1.000 EA
LB1350	BAR CODE LABEL FOR YORK	1.000 EA

AC Induction Motor Performance Data

Record # 53365

Typical performance - not guaranteed values

Winding: 36WGS266-R027		Type: 3632M		Enclosure: TEFC	
Nameplate Data			460 V, 60 Hz: High Voltage Connection		
Rated Output (HP)	3	Full Load Torque	8.8 LB-FT		
Volts	230/460	Start Configuration	direct on line		
Full Load Amps	8.4/4.2	Breakdown Torque	37.6 LB-FT		
R.P.M.	1760	Pull-up Torque	15.2 LB-FT		
Hz	60 Phase	3	Locked-rotor Torque	21.7 LB-FT	
NEMA Design Code	B KVA Code	K	Starting Current	32.7 A	
Service Factor (S.F.)	1.15	No-load Current	2.3 A		
NEMA Nom. Eff.	89.5	Power Factor	75	Line-line Res. @ 25°C	3.81 Ω
Rating - Duty	40C AMB-CONT	Temp. Rise @ Rated Load	44°C		
S.F. Amps		Temp. Rise @ S.F. Load	52°C		
		Locked-rotor Power Factor	42.2		
		Rotor inertia	0.298 LB-FT ²		

Load Characteristics 460 V, 60 Hz, 3 HP

% of Rated Load	25	50	75	100	125	150	S.F.
Power Factor	35	55	68	75	80	82	77
Efficiency	81.1	87.8	89.6	89.8	89.7	88.2	89.2
Speed	1791	1783	1773	1764	1753	1741	1754
Line amperes	2.47	2.85	3.43	4.09	4.89	5.78	4.63

Performance Graph at 460V, 60Hz, 3.0HP Typical performance - Not guaranteed values

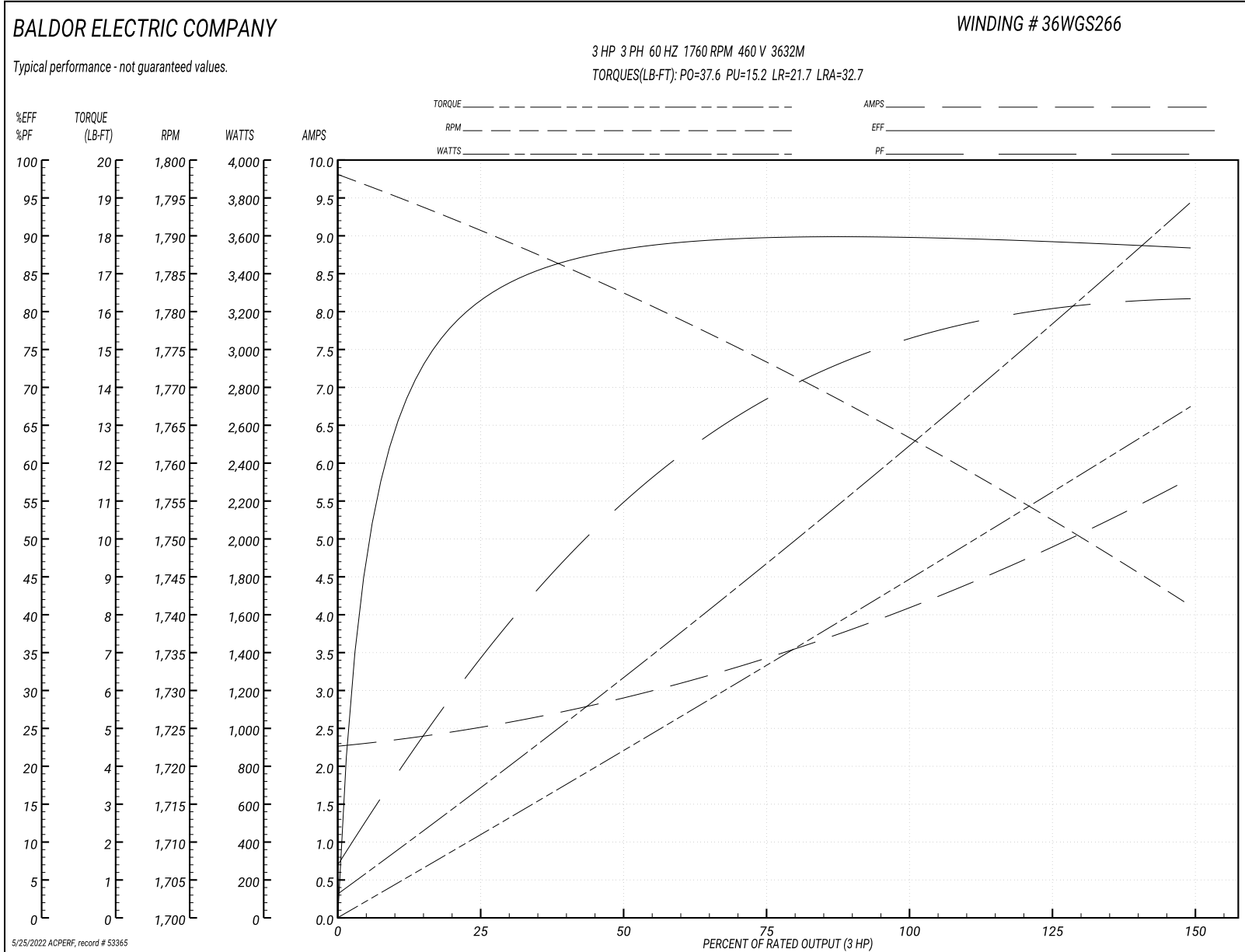

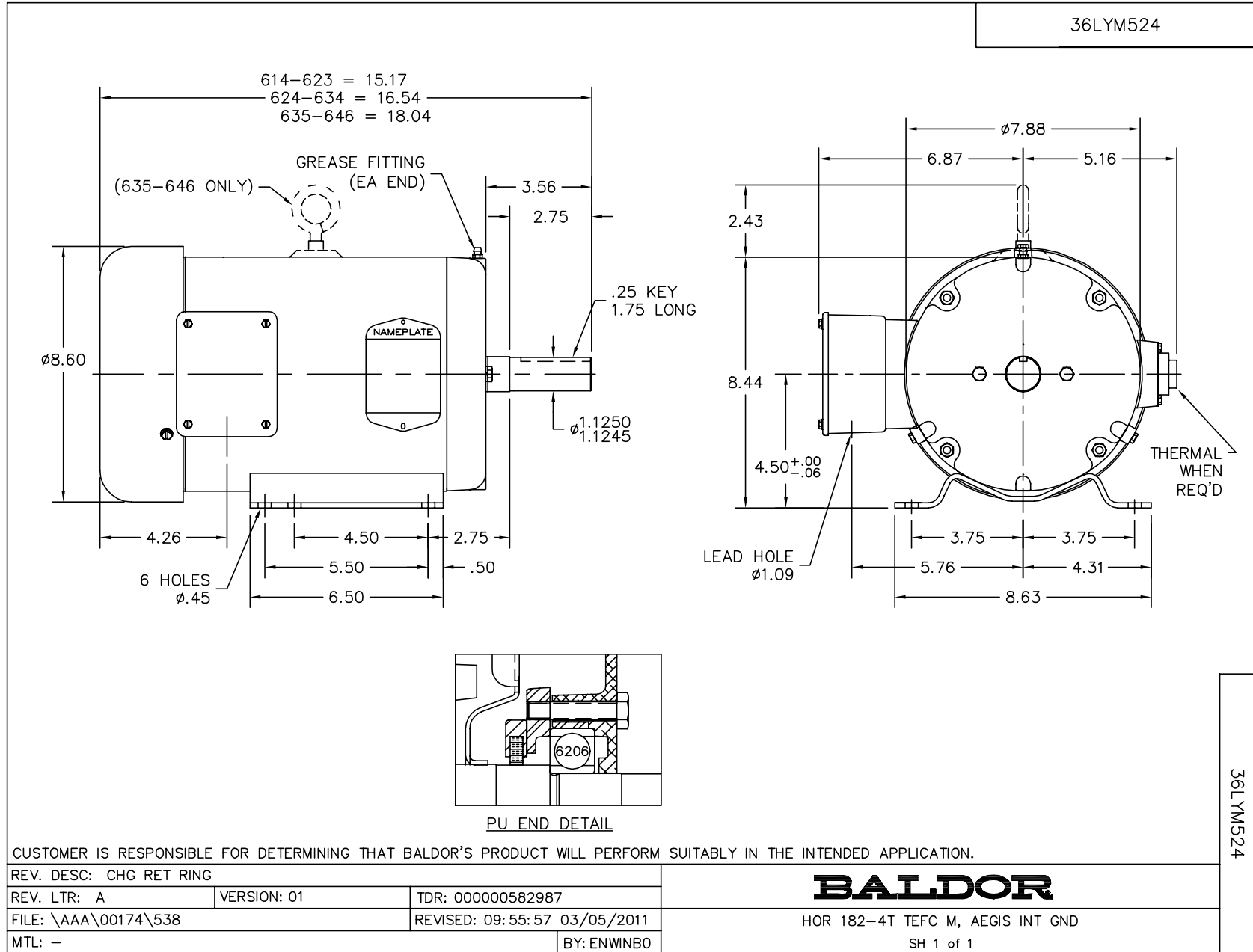

CD0005



LOW VOLTAGE
(2Y)



LINE

HIGH VOLTAGE
(1Y)

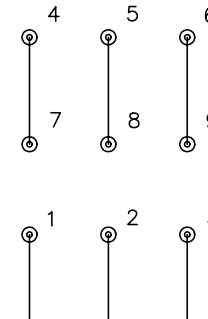

LINE

NOTES:

1. INTERCHANGE ANY TWO LINE LEADS TO REVERSE ROTATION.
2. OPTIONAL THERMOSTATS ARE PROVIDED WHEN SPECIFIED.
3. ACTUAL NUMBER OF INTERNAL PARALLEL CIRCUITS MAY BE A MULTIPLE OF THOSE SHOWN ABOVE.
4. LEAD COLORS ARE OPTIONAL. LEADS MUST ALWAYS BE NUMBERED AS SHOWN.

REV. DESC: REVISE TO SHOW OPTIONAL COLORS			
REV. LTR: E	BY: JLP	REVISED: 01/19/99 10:15	TDR: 0171435
900000		FILE: AAA00005140	MDL: -
		MTL: -	

BALDOR ELECTRIC Co.

3PH, DV, 9 LEADS

CD0005