

**BALDOR® • RELIANCE** 

**Product Information Packet**

**EM3313T-G**

**10HP, 1770RPM, 3PH, 60HZ, 215T, 3742M, OPSB, F1**

Part Detail							
Revision:	A	Status:	PRD/A	Change #:		Proprietary:	No
Type:	AC	Elec. Spec:	37WGL868	CD Diagram:	CD0005	Mfg Plant:	
Mech. Spec:	37J839	Layout:	37LYJ839	Poles:	04	Created Date:	11-11-2020
Base:	RG	Eff. Date:	01-08-2021	Leads:	9#14		

Specs			
Catalog Number:	EM3313T-G	Insulation Class:	H
Enclosure:	OPSB	Inverter Code:	Inverter Ready
Frame:	215T	IP Rating:	NONE
Frame Material:	Steel	KVA Code:	H
Output @ Frequency:	10.000 HP @ 60 HZ	Lifting Lugs:	Standard Lifting Lugs
Synchronous Speed @ Frequency:	1800 RPM @ 60 HZ	Locked Bearing Indicator:	Locked Bearing
Voltage @ Frequency:	460.0 V @ 60 HZ	Motor Lead Quantity/Wire Size:	9 @ 14 AWG
	230.0 V @ 60 HZ	Motor Lead Exit:	Ko Box
XP Class and Group:	None	Motor Lead Termination:	Flying Leads
XP Division:	Not Applicable	Motor Type:	3742M
Agency Approvals:	CSA	Mounting Arrangement:	F1
	CSA EEV	Power Factor:	82
	UR	Product Family:	General Purpose
Auxillary Box:	No Auxillary Box	Pulley End Bearing Type:	Ball
Auxillary Box Lead Termination:	None	Pulley Face Code:	Standard
Base Indicator:	Rigid	Pulley Shaft Indicator:	Standard
Bearing Grease Type:	Polyrex EM (-20F +300F)	Rodent Screen:	None
Blower:	None	RoHS Status:	ROHS COMPLIANT

<b>Current @ Voltage:</b>	12.500 A @ 460.0 V	<b>Shaft Extension Location:</b>	Pulley End
	25.000 A @ 230.0 V	<b>Shaft Ground Indicator:</b>	Shaft Grounding
	26.400 A @ 208.0 V	<b>Shaft Rotation:</b>	Reversible
<b>Design Code:</b>	B	<b>Shaft Slinger Indicator:</b>	No Slinger
<b>Drip Cover:</b>	No Drip Cover	<b>Speed Code:</b>	Single Speed
<b>Duty Rating:</b>	CONT	<b>Motor Standards:</b>	NEMA
<b>Electrically Isolated Bearing:</b>	Not Electrically Isolated	<b>Starting Method:</b>	Direct on line
<b>Feedback Device:</b>	NO FEEDBACK	<b>Thermal Device - Bearing:</b>	None
<b>Front Face Code:</b>	Standard	<b>Thermal Device - Winding:</b>	None
<b>Front Shaft Indicator:</b>	None	<b>Vibration Sensor Indicator:</b>	No Vibration Sensor
<b>Heater Indicator:</b>	No Heater	<b>Winding Thermal 1:</b>	None
		<b>Winding Thermal 2:</b>	None

<b>Nameplate NP3553LUA</b>										
<b>CAT.NO.</b>	EM3313T-G									
<b>SPEC.</b>	37J839L868G1									
<b>HP</b>	10									
<b>VOLTS</b>	230/460									
<b>AMPS</b>	25/12.5									
<b>RPM</b>	1770									
<b>FRAME</b>	215T				<b>HZ</b>	60			<b>PH</b>	3
<b>SF</b>	1.15		<b>CODE</b>	H	<b>DES</b>	B		<b>CLASS</b>	H	
<b>NEMA NOM. EFF</b>	91.7		<b>PF</b>	82						
<b>RATING</b>	40C AMB-CONT									
<b>CC</b>	010A				<b>USABLE AT 208V</b>					26.4
<b>DE</b>	6307				<b>ODE</b>	6206				
<b>ENCL</b>	OPSB		<b>SN</b>							
<b>VPWM INVERTER READY</b>										
<b>CT30-60(2:1) VT3-60(20:1)</b>										
<b>USABLE AT</b>	50HZ 7.5HP 190/380V 23.4/11.7A								<b>SF1.0</b>	

Parts List		
Part Number	Description	Quantity
SA387944	SA 37J839L868G1	1.000 EA
RA378284	RA 37J839L868G1	1.000 EA
HA6361A01	LIFTING LUG FOR 37, 39 & 40 FRAME ZINC	2.000 EA
37CB3006	37 CB CASTING W/1.38 LEAD HOLE @ 6:00	1.000 EA
51XW2520A10	.25-20 X .62, TAPTITE II, HEX WSHR SLTD	2.000 EA
11XW1032G06	10-32 X .38, TAPTITE II, HEX WSHR SLTD U	1.000 EA
37EP3203A00	MASTER,ODE,206 BRG,GREASER	1.000 EA
HW5100A06	W2420-025 WVY WSHR (WB)	1.000 EA
37EP3204B00	MASTER,DE,307 BRG,GREASER,LOCKED BEARING	1.000 EA
10XN2520A28	1/4-20X 1 3/4 HEX HD	4.000 EA
HW1001A25	LOCKWASHER 1/4, ZINC PLT .493 OD, .255 I	4.000 EA
XY3118A12	5/16-18 HEX NUT DIRECTIONAL SERRATION	4.000 EA
37CB4516	LIPPED LID FOR 37 FRAME NEC KOBX	1.000 EA
51XW0832A07	8-32 X .44, TAPTITE II, HEX WSHR SLTD SE	4.000 EA
HW2501F21	KEY, 5/16 SQ X 2.375	1.000 EA
HA7000A02	KEY RETAINER RING, 1 1/8 DIA, 1 3/8 DIA	1.000 EA
85XU0407S04	4X1/4 U DRIVE PIN STAINLESS	2.000 EA
LB1115N	LABEL,LIFTING DEVICE (ON ROLLS)	1.000 EA
LB1459	AEGIS SGR LABEL "AEGISLBL-100"	1.000 EA
MJ1000A02	GREASE, MOBIL POLYREX EM - 124047	0.050 LB
HW4500A01	1641B(ALEMITE)400 UNIV, GREASE FITT	1.000 EA
HW4500A01	1641B(ALEMITE)400 UNIV, GREASE FITT	1.000 EA
HA3104A35	THRUBOLT .31-18 X 13.687	4.000 EA
37AD2001A01	BAFFLE PLATE, PLASTIC 0.63" WIDTH	2.000 EA

<b>Parts List (continued)</b>		
<b>Part Number</b>	<b>Description</b>	<b>Quantity</b>
MG1000Y03	MUNSELL 2.53Y 6.70/ 4.60, GLOSS 20,	0.028 GA
LC0005E01	CONN.DIA./WARNING LABEL (LC0005/LB1119N)	1.000 EA
NP3553LUA	ALUM SUPER-E VPWM INVERTER READY UL	1.000 EA
36PA1001	PKG GRP, PRINT PK1017A06	1.000 EA
MN416A01	TAG-INSTAL-MAINT no wire (2100/bx) 4/22	1.000 EA
LB1350	BAR CODE LABEL FOR YORK	1.000 EA
LB1304	LABEL "INVERTER READY"	1.000 EA
FE-0000001	ZRTG FE ASSEMBLY	1.000 EA
PE-0000001	ZRTG PE ASSEMBLY	1.000 EA

**AC Induction Motor Performance Data**

Record # 85454

Preliminary Data Sheet

<b>Winding: 37WGL868-RXXX</b>		<b>Type: 3742M</b>		<b>Enclosure: OPSB</b>	
<b>Nameplate Data</b>			<b>460 V, 60 Hz: High Voltage Connection</b>		
<b>Rated Output (HP)</b>	10	<b>Full Load Torque</b>	29.8 LB-FT		
<b>Volts</b>	230/460	<b>Start Configuration</b>	direct on line		
<b>Full Load Amps</b>	25.0/12.5	<b>Breakdown Torque</b>	101 LB-FT		
<b>R.P.M.</b>	1770	<b>Pull-up Torque</b>	44.9 LB-FT		
<b>Hz</b>	60 Phase	<b>Locked-rotor Torque</b>	56 LB-FT		
<b>NEMA Design Code</b>	B	<b>Starting Current</b>	88.6 A		
<b>Service Factor (S.F.)</b>	1.15	<b>No-load Current</b>	5.31 A		
<b>NEMA Nom. Eff.</b>	91.7	<b>Line-line Res. @ 25°C</b>	1.18 Ω		
<b>Rating - Duty</b>	40C AMB-CONT	<b>Temp. Rise @ Rated Load</b>	35°C		
<b>S.F. Amps</b>	28.0/14.0	<b>Temp. Rise @ S.F. Load</b>	44°C		
		<b>Locked-rotor Power Factor</b>	42.6		
		<b>Rotor inertia</b>	1.03 lb-ft <sup>2</sup>		

**Load Characteristics 460 V, 60 Hz, 10 HP**

<b>% of Rated Load</b>	<b>25</b>	<b>50</b>	<b>75</b>	<b>100</b>	<b>125</b>	<b>150</b>	<b>S.F.</b>
<b>Power Factor</b>	45	67	77	82	84	85	84
<b>Efficiency</b>	86.7	91.3	92.1	91.7	90.9	89.6	91.1
<b>Speed</b>	1792	1785	1777	1769	1760	1750	1762
<b>Line amperes</b>	6.04	7.69	9.84	12.4	15.3	18.4	14.1

Performance Graph at 460V, 60Hz, 10.0HP Typical performance - Not guaranteed values

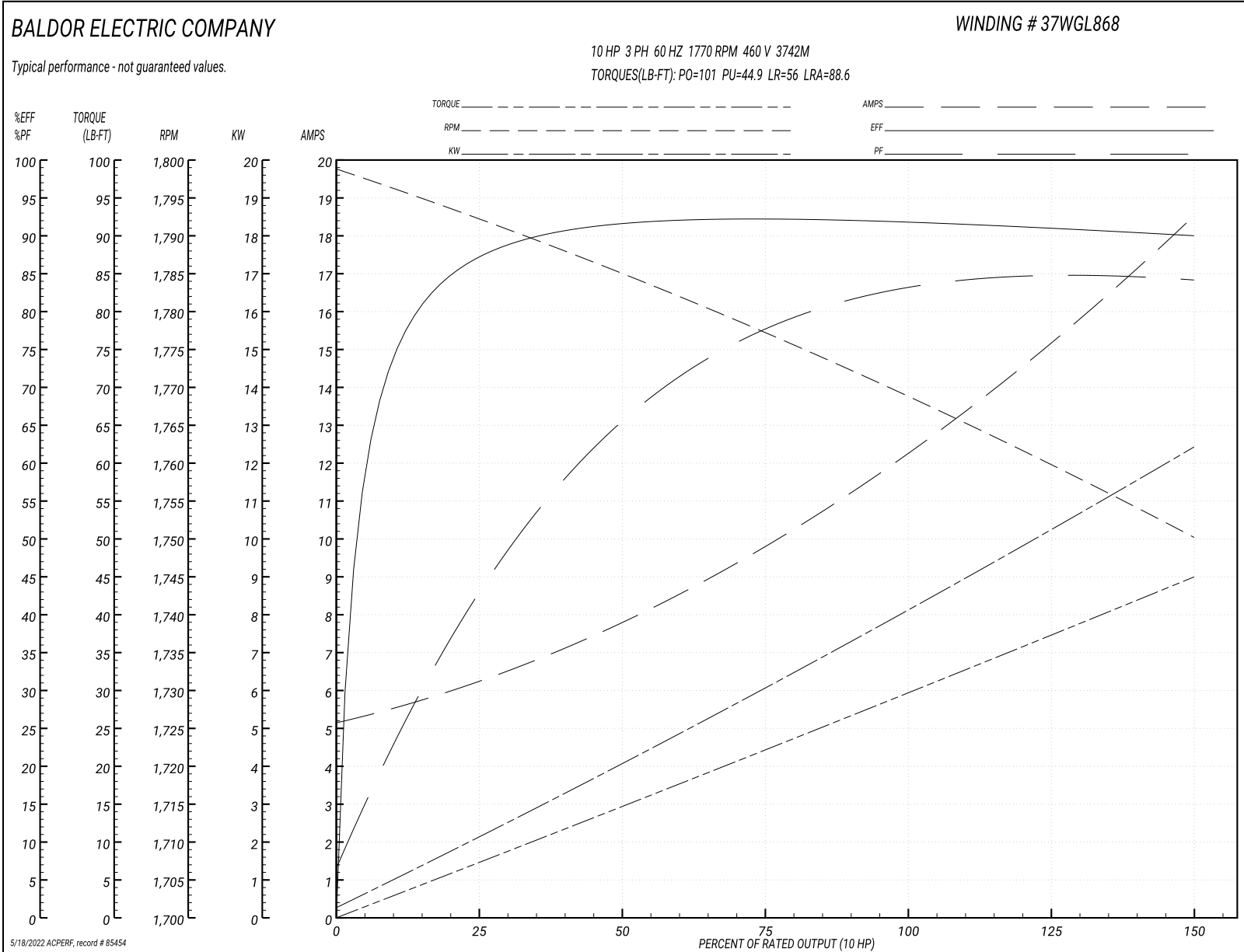

37LYJ839

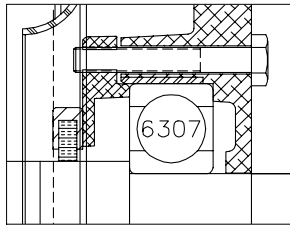
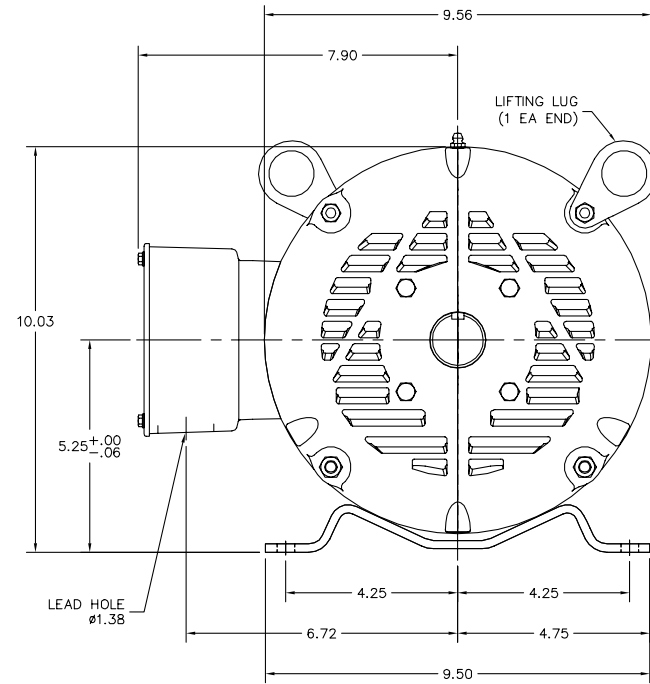
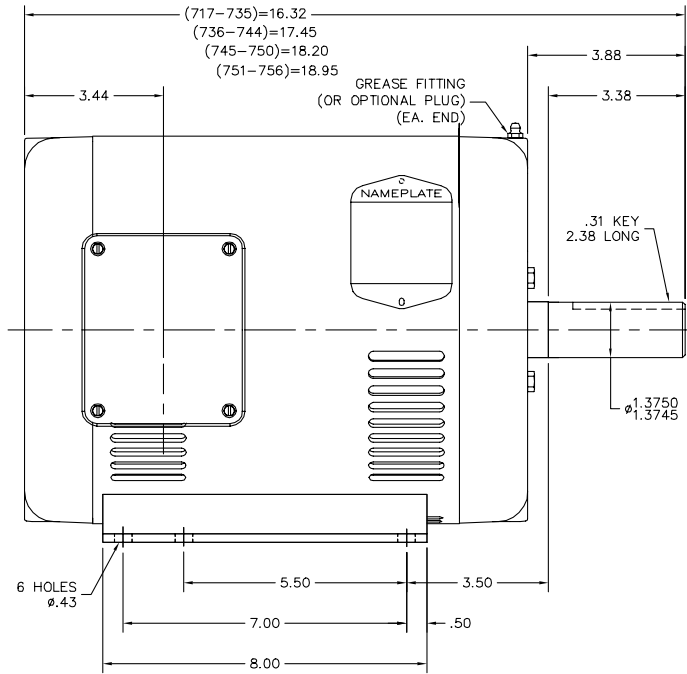

PU END DETAIL

CUSTOMER IS RESPONSIBLE FOR DETERMINING THAT BALDOR'S PRODUCT WILL PERFORM SUITABLY IN THE INTENDED APPLICATION.

REV. DESC: ADD GREASE PLUG TO GREASER CALLOUT	VERSION: 01	TDR: 000001115109
REV. LTR: A	REVISED: 11:42:58 07/22/2019	BY: ENWINBO
FILE: \AAA\00174\569		
MTL: -		

**BALDOR - RELIANCE**®

HOR 213-5T OPSB M, AEGIS INT SHAFT GND

SH 1 of 1

37LYJ839

CD0005



LOW VOLTAGE  
(2Y)



LINE

HIGH VOLTAGE  
(1Y)



LINE

NOTES:

1. INTERCHANGE ANY TWO LINE LEADS TO REVERSE ROTATION.
2. OPTIONAL THERMOSTATS ARE PROVIDED WHEN SPECIFIED.
3. ACTUAL NUMBER OF INTERNAL PARALLEL CIRCUITS MAY BE A MULTIPLE OF THOSE SHOWN ABOVE.
4. LEAD COLORS ARE OPTIONAL. LEADS MUST ALWAYS BE NUMBERED AS SHOWN.

REV. DESC: REVISE TO SHOW OPTIONAL COLORS			
REV. LTR: E	BY: JLP	REVISED: 01/19/99 10:15	TDR: 0171435
900000		FILE: AAA00005140	MDL: -
		MTL: -	

**BALDOR ELECTRIC Co.**

3PH, DV, 9 LEADS

CD0005