

Part No.	Reference No.	Quantity	Description
AFDUP6_AFDUP6_173171~P	*		AFDUP6 PARTS LIST
75006840#AFDUP6~S	*		MODEL NOMENCLATURE
75008214#AFDUP6~S	*		WHOLE HOUSE AIR CLEANER

NO GRAPHIC AVAILABLE

75013702

REV
A

**NO
GRAPHIC
AVAILABLE**

NOMENCLATURE														75006840	REV A
Whole House Air Cleaner Units															
Model Number Digit	1	2	3	4	5	6	7	8	9	10	11	12	13	14	15
	Brand	Accessory Type	Accessory Type	Model Series	Model Series	Model Series	Equipment Application	Equipment Application	Major Modification	Voltage	Equipment Application	Equipment Application	Not Used	Minor Modification	Service Digit
ifD Feature	Example														
Trane	T														
American Standard	A														
Filtration		F													
ifD			D												
Model Series Dimension				1	4	5									
Model Series Dimension Downflow				1	4	D									
Model Series Dimension				1	7	5									
Model Series Dimension Downflow				1	7	D									
Model Series Dimension				2	1	0									
Model Series Dimension Downflow				2	1	D									
Model Series Dimension				2	4	5									
Model Series Dimension Downflow				2	4	D									
Model Series Dimension				2	1	5									
Model Series Dimension				2	3	5									
Model Series Dimension				2	6	0									
Major Design Series							A								
Power Supply L = low voltage								L							
Application FR = Furnace									F	R					
Application AH = Air Handler									A	H					
Not Used											0	0	0		
Minor Design														A	
Service Digit A,B,C, etc.															A
Models															
14.5" Furnace	T	F	D	1	4	5	A	L	F	R	0	0	0	A	A
14.5" Furnace Downflow	T	F	D	1	4	D	A	L	F	R	0	0	0	A	A
17.5" Furnace	T	F	D	1	7	5	A	L	F	R	0	0	0	A	A
17.5" Furnace Downflow	T	F	D	1	7	D	A	L	F	R	0	0	0	A	A
21" Furnace	T	F	D	2	1	0	A	L	F	R	0	0	0	A	A
21" Furnace Downflow	T	F	D	2	1	D	A	L	F	R	0	0	0	A	A
24.5" Furnace	T	F	D	2	4	5	A	L	F	R	0	0	0	A	A
24.5" Furnace Downflow	T	F	D	2	4	D	A	L	F	R	0	0	0	A	A
21.5" Air Handler	T	F	D	2	1	5	A	L	A	H	0	0	0	A	A
23.5" Air Handler	T	F	D	2	3	5	A	L	A	H	0	0	0	A	A
26" Air Handler	T	F	D	2	6	0	A	L	A	H	0	0	0	A	A

Part No.	Reference No.	Quantity	Description
75006840_AFDUP6_173172-P	*		MODEL NOMENCLATURE PARTS LIST

NOMENCLATURE														75006840	REV A
Whole House Air Cleaner Units															
Model Number Digit	1	2	3	4	5	6	7	8	9	10	11	12	13	14	15
	Brand	Accessory Type	Accessory Type	Model Series	Model Series	Model Series	Equipment Application	Equipment Application	Major Modification	Voltage	Equipment Application	Equipment Application	Not Used	Minor Modification	Service Digit
ifD Feature	Example														
Trane	T														
American Standard	A														
Filtration		F													
ifD			D												
Model Series Dimension				1	4	5									
Model Series Dimension Downflow				1	4	D									
Model Series Dimension				1	7	5									
Model Series Dimension Downflow				1	7	D									
Model Series Dimension				2	1	0									
Model Series Dimension Downflow				2	1	D									
Model Series Dimension				2	4	5									
Model Series Dimension Downflow				2	4	D									
Model Series Dimension				2	1	5									
Model Series Dimension				2	3	5									
Model Series Dimension				2	6	0									
Major Design Series							A								
Power Supply L = low voltage								L							
Application FR = Furnace									F	R					
Application AH = Air Handler									A	H					
Not Used											0	0	0		
Minor Design														A	
Service Digit A,B,C, etc.															A
Models															
14.5" Furnace	T	F	D	1	4	5	A	L	F	R	0	0	0	A	A
14.5" Furnace Downflow	T	F	D	1	4	D	A	L	F	R	0	0	0	A	A
17.5" Furnace	T	F	D	1	7	5	A	L	F	R	0	0	0	A	A
17.5" Furnace Downflow	T	F	D	1	7	D	A	L	F	R	0	0	0	A	A
21" Furnace	T	F	D	2	1	0	A	L	F	R	0	0	0	A	A
21" Furnace Downflow	T	F	D	2	1	D	A	L	F	R	0	0	0	A	A
24.5" Furnace	T	F	D	2	4	5	A	L	F	R	0	0	0	A	A
24.5" Furnace Downflow	T	F	D	2	4	D	A	L	F	R	0	0	0	A	A
21.5" Air Handler	T	F	D	2	1	5	A	L	A	H	0	0	0	A	A
23.5" Air Handler	T	F	D	2	3	5	A	L	A	H	0	0	0	A	A
26" Air Handler	T	F	D	2	6	0	A	L	A	H	0	0	0	A	A

Whole House Air Cleaner

75008214

REV
A

Typical Illustration. Unit may not appear exactly as shown.

The Complete Accessory Must Be Ordered
Through Sales

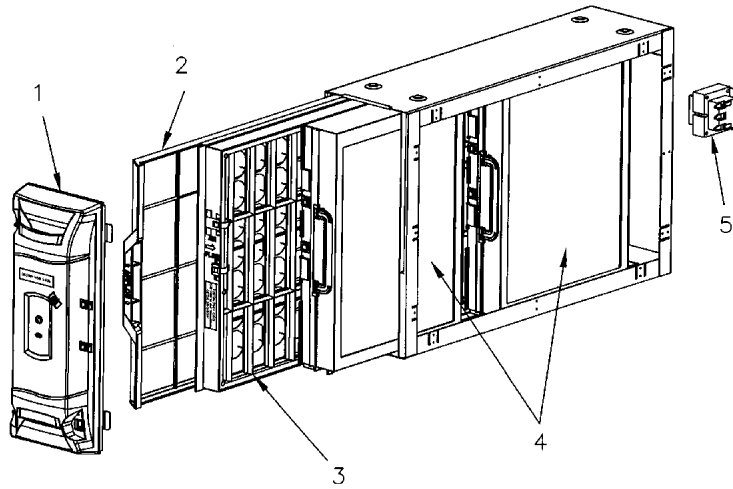

* Not Illustrated.

Part No.	Reference No.	Quantity	Description
75008214_AFDUP6_245401-P	*		WHOLE HOUSE AIR CLEANER PARTS LIST

Whole House Air Cleaner

75008214

REV
A

Typical Illustration. Unit may not appear exactly as shown.

The Complete Accessory Must Be Ordered
Through Sales

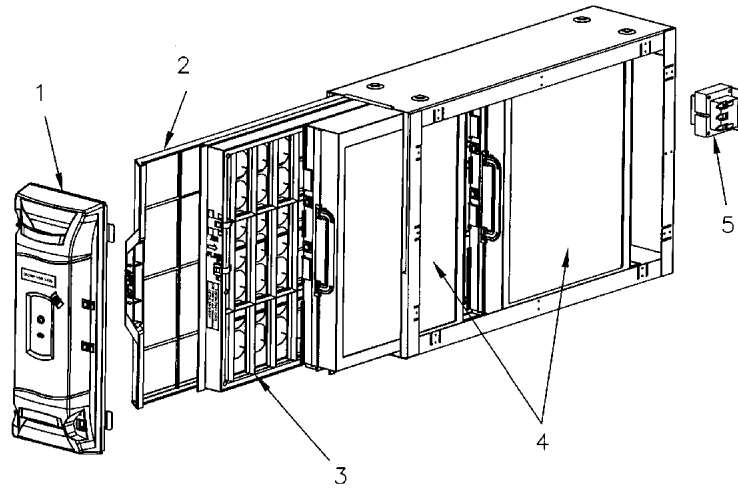

* Not Illustrated.

Part No.	Reference No.	Quantity	Description
CAB01157	*	1	CABLE; POWER CONTROL, (2 X 3 PLUG WITH THERMOSTAT WIRE)
CNT06888	*	1	CONTROL; PCB ASSEMBLY, ACCE MAIN BOARD, 3.50 X 3.12
FUS01349	*	1	FUSE; 3A FLAT BLADE, ATC-3 (5EA/CASE)
GKT04095	*	2	GASKET; 25.830 X .375, BLACK URETHANE (LOCATED WHERE THE POWER PACK DOOR CONNECTS TO CABINET)
HDL01001	*	1	HANDLE; 6.37 X 1.47
INS02761	*	1	INSULATOR; 18.00 X 5.00
KIT12582	*	1	KIT; DOOR BASE ASSEMBLY (CONSISTS OF OUTER HOUSING ASSY, TOP KNOB, BOTTOM KNOB, 2-WASHERS, WARNING LABEL, IFD LOGO LABEL, & TRANE/AMER STD LOGO LABELS)
KIT12586	*	1	KIT; CONTACT DISC ASSEMBLY (CONSISTS OF 2-NEG CONTACT BODY, 1-HV CONTACT BODY, 3-CONTACT DISC'S, 3-SPRING'S, & 3-SLEEVE'S)
KIT12610	*	1	KIT; LATCH ASSEMBLY (CONSISTS OF 2-LATCHES, 2-KNOBS, 2-SCREWS)
KIT13735	*	1	KIT; GASKET, LITERATURE AND HARDWARE PACKET, AMERICAN STANDARD (KIT CONTAINS: INSTALLATION GUIDE, DRILL POINT SCREWS, GASKET STRIPS, ELECTRICAL HARNES)
KIT16529	1	1	KIT; COMPLETE COMMUNICATING POWER PACK DOOR ASSEMBLY
FLR06466	2	1	FILTER; PRE-FILTER, 24.19 LONG X 26.07 WIDE
CHG00061	3	1	CHARGER; FIELD CHARGER ASSEMBLY, 24.3 X 26.3
FLR06455	4	1	FILTER; IFD-FILTER ASSEMBLY (PACKAGE OF 2 FILTERS) (COLLECTION CELL)
TRR02067	5	1	TRANSFORMER; 115V PRI, 24V SEC, 60 HZ, 50 VA