

Part No.	Reference No.	Quantity	Description
000086608~S	*		BLOWER
000086609~S	*		CABINET
000086610~S	*		COIL
000086611~S	*		CONTROLS
000086686~S	*		GENERAL ASSEMBLY
0000101893~S	*		MODEL NUMBER DESCRIPTION
000086612~S	*		OPTIONAL EQUIPMENT

Part No.	Reference No.	Quantity	Description
000002602~P	*		BLOWER PARTS LIST

BLOWER

75012595

RP
A

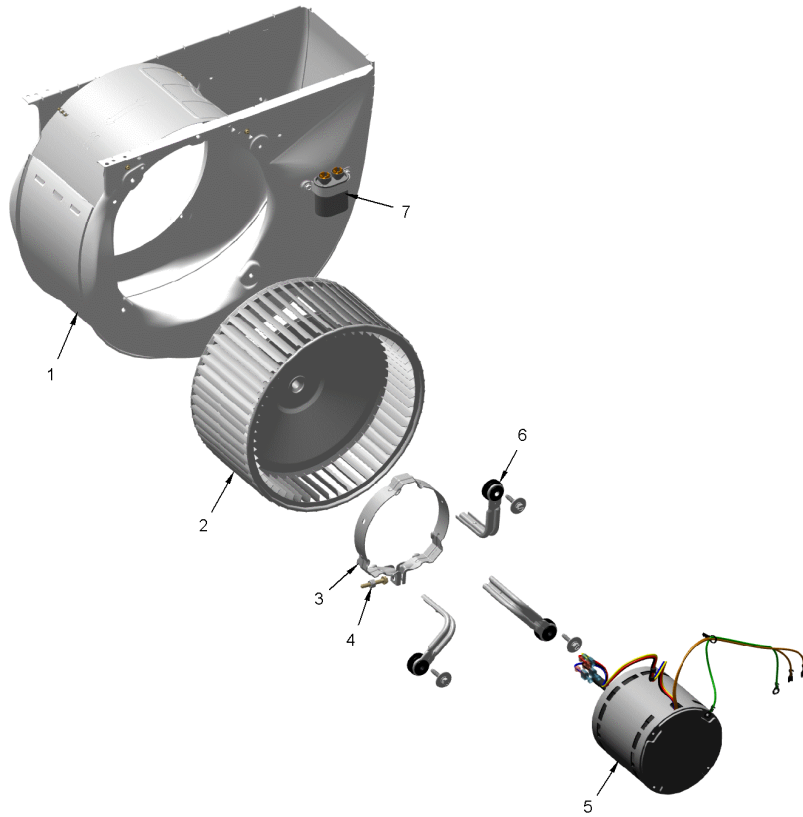

This is a typical illustration. The unit in the field may not appear exactly as shown.

Part No.	Reference No.	Quantity	Description
HUS04350	1	1	HOUSING; BLOWER, METAL, 6.325 INTERIOR WIDTH
WHL03717	2	1	WHEEL; BLOWER, 12.15 IN DIA, 6.06 IN WIDTH, 0.50 IN BORE, 54 BLADES, CW
BND00910	3	1	BAND; MOTOR MOUNT
NUT01063	4a	1	NUT; LOCKING NYLON
SCR01584	4b	1	BOLT; 1/4-20 MA HX 1.5 S
MOT18582	5	1	MOTOR; 1/5 HP, 208-230/60/1, 825 RPM, TYPE PSC, NEMA 48 FRAME, BALL BEARING, 5 MFD CPT AT 440V
BRK05027	6	1	BRACKET; MOTOR MOUNT, 3.28 X 3.25, INCLUDES GROMMET
CPT00119	7a	1	CAPACITOR; RUN, 5 MFD, 440V, OVAL, W/O RESISTOR
SRP00091	7b	1	STRAP, CAPACITOR

Part No.	Reference No.	Quantity	Description
000002603~P	*		CABINET PARTS LIST



Part No.	Reference No.	Quantity	Description
PNL36869	1	1	PANEL; INSUL ASM-WRAPPER
PNL36871	2	1	PANEL; INSUL ASM-TOP COVER
SUP06387	4	1	SUPPORT; BLOWER SHELF, 13.57 X 17.95 X 7.94
PNL36864	6	1	PANEL; INSUL ASM-BLOWER
PNL36860	7	1	PANEL; INSUL ASM-COIL
PNL36862	8	1	PANEL; INSUL ASM-LINE SET
GRM00863	9	1	GROMMET; SUCTION GROMMET
GRM00864	10	1	GROMMET; CONE GROMMET, LIQUID LINE
SUP05665	11	1	SUPPORT; CROSSMEMBER, MIDDLE, 17.39 L
SUP05662	12	1	SUPPORT; COIL SHIELD, RIGHT, 20.04 X 7.72
SUP05663	13	1	SUPPORT; CROSSMEMBER, BOTTOM, 18.37 L
SUP05661	14	1	SUPPORT; COIL SHIELD, LEFT, 20.04 X 7.72

Part No.	Reference No.	Quantity	Description
000002681~P	*		COIL PARTS LIST

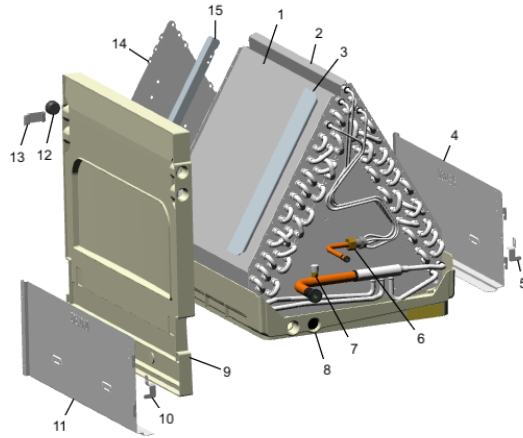

Part No.	Reference No.	Quantity	Description
COL31304	1	1	COIL; ASSEMBLY, INCLUDES DRAIN PAN & TXV
COL31099	1A	1	COIL, BLK EPOXY; ASSEMBLY, INCLUDES DRAIN PAN & TXV
DIV00332	2	1	DIVERTER; COIL, 16.38 X 1.20 X 0.57
DIV00331	3	1	DIVERTER, COIL
SUP05662	4	2	SUPPORT; COIL SHIELD, RIGHT, 20.04 X 7.72
BRK04501	5	1	BRACKET; COIL, 1.73 X 1.00 X 0.46, RIGHT SIDE
NUT01223	6a	1	NUT; HEX NUT, 7/8, 3/4-20-2B UNEF THREAD
WAS01180	6b	1	WASHER; TEFLON, 0.46 ID X 0.56 OD X 0.056 THK
BOD00114	7a	1	BODY; VALVE, BRASS, 7/16 HEX, 7/16 -20 UNF-2A
COR00103	7b	1	CORE; VALVE, .79 LENGTH, .206-36 UNS-1 MOD. THD
CAP00455	7c	1	CAP; HUB, 7/16-20 STRAIGHT
PAN03384	8a	1	PAN; DRAIN, UPFLOW, 16.50 X 20.07
PLU01169	8b	1	PLUG; THREADED 3/4
PAN03386	9	1	PAN; DRAIN, HORIZONTAL, 20.67 X 20.38
BRK04500	10	1	BRACKET; COIL, 1.73 X 1.00 X 0.46, LEFT SIDE
SUP05661	11	1	SUPPORT; COIL SHIELD, LEFT, 20.04 X 7.72
PLU01169	12	1	PLUG; THREADED 3/4
BRK04471	13	1	BRACKET; DRAIN PAN CLIP
BAF01413	14	1	BAFFLE; COIL
DIV00338	15	1	DIVERTER; COIL REAR

Part No.	Reference No.	Quantity	Description
000002647~P	*		CONTROLS PARTS LIST

CONTROLS

75012597

RP
A

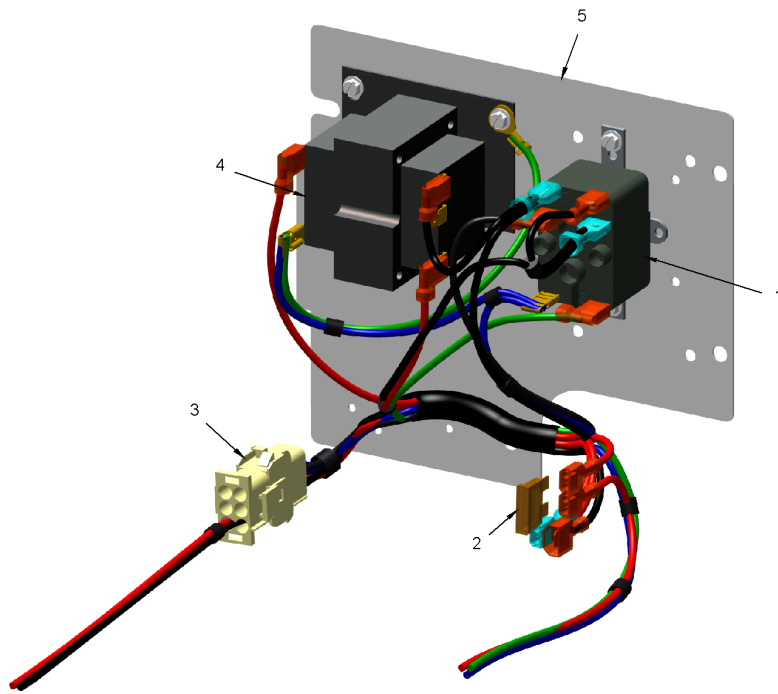

This is a typical illustration. The unit in the field may not appear exactly as shown.

Part No.	Reference No.	Quantity	Description
RLY01951	1	1	RELAY; SPDT, NO-NC, 24CV, REVERSING
FUS01089	2	1	FUSE; 5 AMP, TAN, AUTOMOTIVE STYLE
WIR08988	3	1	WIRE; HARNESS, ASM-PSC
TRR01557	4	1	TRANSFORMER; 40VA, 200/230V PRI, 24V SEC
PLT05625	5	1	PLATE; CONTROL, 7.38 X 6.69

Part No.	Reference No.	Quantity	Description
000004267~P	*		GENERAL ASSEMBLY GRAPHIC

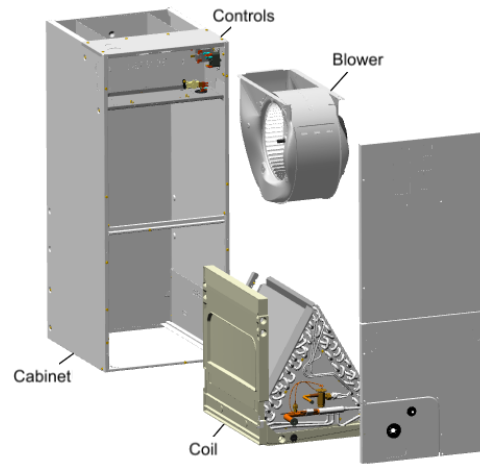

Part No.	Reference No.	Quantity	Description
000009818~P	*		MODEL NUMBER GRAPHIC

MODEL NUMBER DESCRIPTION

75013901

REV
A

AIR HANDLER

Example Model Number:

A 4 A H 4 P 2 4 A 1 B 3 0 A A
1 - - - 5 - - - 10 - - - 15

Digit 1 – Brand

A = RunTru Brand

Digit 2 – Refrigerant Type

4 = R410a

Digit 3,4 – Product Family

AH = Air Handler Unit

Digit 5 – Nominal Efficiency Rating

4 = 14 SEER

6 = 16 SEER

Digits 6 – Blower Type

P = PSC

V = Variable Speed

E = Constant Torque ECM

Digit 7,8 – Nominal Capacity

BTU/HOUR x 1000

Digit 9 – Major Development Sequence

Digit 10 – Electric Power Supply

1 = 200-230/1PH/60Hz or 208-230/1PH/60Hz

Digit 11 – Cabinet Width Size

B = 18"

C = 23.5"

D = 26.5"

Digit 12 – Refrigerant Control

3 = TXV Non-Bleed

6 = FCCV (Flow Control/Check Valve)

Digit 13 – Placeholder

0 - Nothing/Blank

Digit 14 – Minor Design Modifications

Digit 15 – Unit Parts Identifier

Part No.	Reference No.	Quantity	Description
000002624~P	*		OPTIONAL EQUIPMENT LIST

Part No.	Reference No.	Quantity	Description
BAYATXV1836B	*	1	KIT; FIELD MOUNTED TXV
BAYHTR1504LUGB	*	1	4KW HEATER LUGS
BAYHTR1505LUGB	*	1	5KW HEATER LUGS
BAYHTR1508LUGB	*	1	8KW HEATER LUGS
BAYHTR1510LUGB	*	1	10KW HEATER LUGS
BAYSF1185BAA	*	1	1 IN FILTER AND INSULATED FRAME, 18.5 IN
BAYSPEKT201A	*	1	KIT; SINGLE POINT POWER ENTRY (BAYSPEKT201A)
BAYTEMSPFG1A	*	1	DUCT FLANGE KIT
FLRSF1185	*	1	FILTER; 1 INCH MERV 4 FILTER, 17.75X19.75X.75 (1 EACH = 12 FILTERS)
KIT18054	*	1	KIT; EMI/EFI AIR HANDLER ELECTRIC NOISE KIT FOR VARIABLE SPEED BLOWER MOTOR (BAYAHEMIKIT001A)
TAYBASE185	*	1	KIT; DOWNFLOW SUB-BASE KIT, 18.5 CABINET
TAYBASE235	*	1	DOWNFLOW SUB-BASE KIT
TEMBRKSEALKT01A	*	1	KIT-BREAKER SEAL