

Part No.	Reference No.	Quantity	Description
4TXUUP1_4TXUUP1_147268~P	*		4TXUUP1 PARTS LIST
75010848#4TXUUP1~S	*		GENERAL ASSEMBLY CASSETTE 2.5, 3.0, 3.5 TON
75010846#4TXUUP1~S	*		MODEL NOMENCLATURE

NO GRAPHIC AVAILABLE

75013702

REV
A

**NO
GRAPHIC
AVAILABLE**

MODEL NUMBER DESCRIPTION
INDOOR PRO SERIES MODEL NOMENCLATURE

75010846

REV.
A

Example Model Number:
4UXC2018A10N0AA
1 - - - 5 - - - - 10 - - - - 15

Digit 1 – Refrigerant

4 = R-410A

Digit 2 – Brand

U = Pro Series
M = Indoor Unit

Digit 3 – Functional Type

X = Heat Pump Inverter

Digit 4 – Configuration Indoor Unit

C = Cassette Unit
D = Concealed (Duct) Unit
L = Cassette Covers

Digits 5, 6 – Efficiency Tier

20 = Up to 20 SEER Pro Series

Digits 7, 8 – Nominal Capacity (Btu/h x 1,000)

18 = 18,000 Btu/h
24 = 24,000 Btu/h
30 = 30,000 Btu/h
36 = 36,000 Btu/h
42 = 42,000 Btu/h
48 = 48,000 Btu/h

Digit 9 – Major Development Sequence

A = First Development Sequence

Digit 10 – Electric Power Supply

1 = 208-230/60/1

Digit 11 – Reserved for Future Use

0 = Not Currently Used

Digit 12 – Regional Markets Served

N = North America Market

Digit 13 – Reserved for Future Use

0 = Not Currently Used

Digit 14 – Minor Design Sequence

A = First Design Sequence

Digit 15 – Service Digit

A = First Sequence

Part No.	Reference No.	Quantity	Description
75010846_4TXUUP1_182410~P	*		MODEL NOMENCLATURE PARTS LIST

MODEL NUMBER DESCRIPTION
INDOOR PRO SERIES MODEL NOMENCLATURE

75010846

REV.
A

Example Model Number:
4 UXC 20 18 A 10 N0 AA
1 - - - 5 - - - - 10 - - - - 15

Digit 1 – Refrigerant
4 = R-410A

Digit 2 – Brand
U = Pro Series
M = Indoor Unit

Digit 3 – Functional Type
X = Heat Pump Inverter

Digit 4 – Configuration Indoor Unit
C = Cassette Unit
D = Concealed (Duct) Unit
L = Cassette Covers

Digits 5, 6 – Efficiency Tier
20 = Up to 20 SEER Pro Series

Digits 7, 8 – Nominal Capacity (Btu/h x 1,000)
18 = 18,000 Btu/h
24 = 24,000 Btu/h
30 = 30,000 Btu/h
36 = 36,000 Btu/h
42 = 42,000 Btu/h
48 = 48,000 Btu/h

Digit 9 – Major Development Sequence
A = First Development Sequence

Digit 10 – Electric Power Supply
1 = 208-230/60/1

Digit 11 – Reserved for Future Use
0 = Not Currently Used

Digit 12 – Regional Markets Served
N = North America Market

Digit 13 – Reserved for Future Use
0 = Not Currently Used

Digit 14 – Minor Design Sequence
A = First Design Sequence

Digit 15 – Service Digit
A = First Sequence

GENERAL ASSEMBLY

75010848

REV
A

INDOOR 2.5, 3.0, 3.5 TON PRO SERIES HEAT PUMP INVERTER CASSETTE
TYPICAL ILLUSTRATION

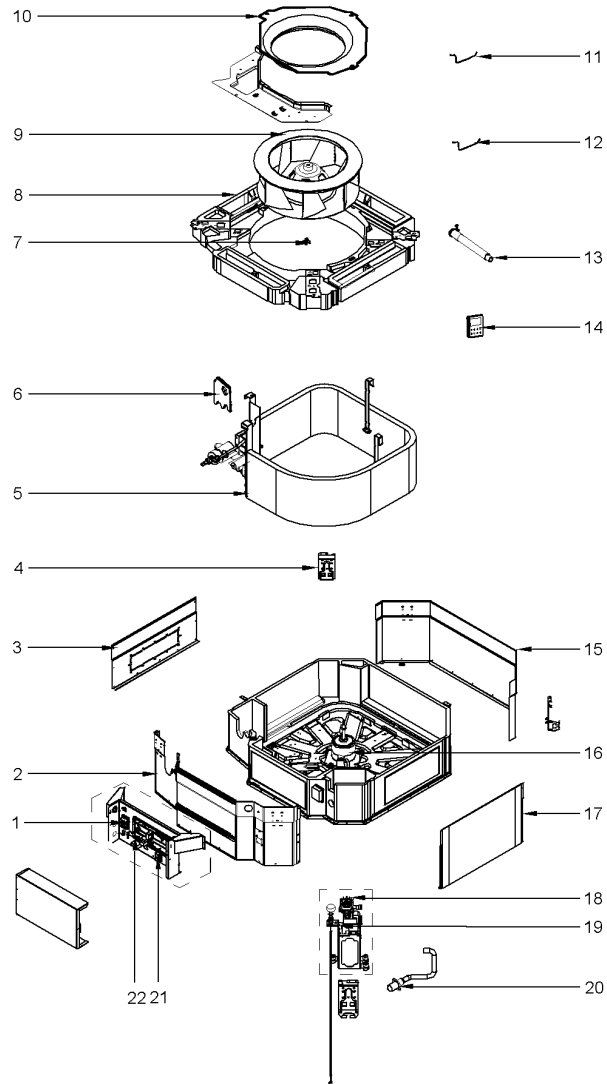

Parts List Number :4TXUUP1#4TXUUP1

Model Number :4UXC2036A10N0AA

Part No.	Reference No.	Quantity	Description
75010848_4TXUUP1_238260~P	*		GENERAL ASSEMBLY CASSETTE 2.5, 3.0, 3.5 TON PARTS LIST

GENERAL ASSEMBLY

75010848

REV
A

INDOOR 2.5, 3.0, 3.5 TON PRO SERIES HEAT PUMP INVERTER CASSETTE
TYPICAL ILLUSTRATION

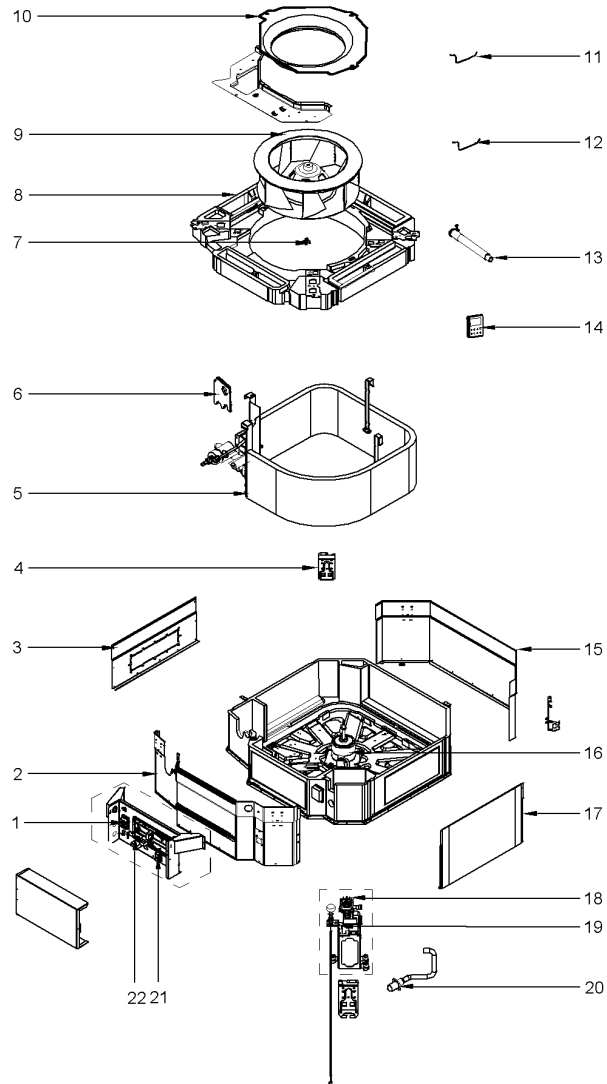

Parts List Number :4TXUUP1#4TXUUP1

Model Number :4UXC2036A10N0AA

Part No.	Reference No.	Quantity	Description
BRD05243	1	1	BOARD; TERMINAL
PNL32146	2	1	PANEL; FRONT SIDE PLATE ASSY
PNL32135	3	1	PANEL; LEFT SIDE PLATE ASSY
PLT05627	4	4	PLATE; BODY INSTALLING
COL25491	5	1	COIL; GREE, 01029400042
PLT05629	6	1	PLATE; TUBE EXIT ASSY
SPC00528	7	1	SPACER; FAN FIXER
PAN03410	8	1	PAN; WATER TRAY ASSY
FAN05462	9	1	FAN; CENTRIFUGAL
RNG02373	10	1	RING; DIVERSION CIRCLE
SEN02375	11	1	SENSOR; TEMPERATURE
SEN02373	12	1	SENSOR; AMBIENT TEMPERATURE
HSE01876	13	1	HOSE; DRAIN SUB-ASSY
BRD05262	14	1	BOARD; DISPLAY (WIRED CONTROLLER XK60)
PNL32134	15	1	PANEL; REAR SIDE PLATE ASSY
MOT17029	16	1	MOTOR; BRUSHLESS DC
PNL32136	17	1	PANEL; RIGHT SIDE PLATE ASSY
PMP02193	18	1	PUMP; WATER
SWT03733	19	1	SWITCH; WATER LEVEL
PIP02078	20	1	PIPE; PUMP DRAIN
BRD05246	21	1	BOARD; TERMINAL
BRD05255	22	1	BOARD; MAIN