

Part No.	Reference No.	Quantity	Description
75011392#4TXMUP2-S	*		2.5, 3.0 & 3.5 TON ELECTRIC BOX ASSEMBLY
75011393#4TXMUP2-S	*		2.5, 3.0 & 3.5 TON FAN, ELECTRIC HEATER & PANELS
75011394#4TXMUP2-S	*		2.5, 3.0 & 3.5 TON REFRIGERATION & MISCELLANEOUS PARTS
4TXMUP2_4TXMUP2_237738-P	*		4TXMUP2 PARTS LIST
75011403#4TXMUP2-S	*		MODEL NOMENCLATURE

NO GRAPHIC AVAILABLE

75013702

REV
A

**NO
GRAPHIC
AVAILABLE**

MODEL NUMBER DESCRIPTION	75011403	REV. A
22 SEER		
<i>Example Model Number:</i> 4TXM2218A12N0AA <small>1 - - - - 5 - - - - 10 - - - - 15</small>		
Digits 1 – Refrigerant 4 = R-410A		
Digits 2 – Brand T = Outdoor Unit		
Digits 3 – Functional Type X = Heat Pump Inverter		
Digits 4 – Configuration Outdoor Unit M = Multiple Refrigerant Ports		
Digits 5, 6 – Efficiency Tier 22 = Up To 22 SEER		
Digits 7, 8 – Nominal Capacity (Btu/h x 1,000) 18 = 18,000 Btu/h 21 = 21,000 Btu/h 24 = 24,000 Btu/h 30 = 30,000 Btu/h 36 = 36,000 Btu/h 42 = 42,000 Btu/h		
Digits 9 – Major Development Sequence A = First Development Sequence		
Digits 10 – Electric Power Supply Characteristics 1 = 208-230/60/1		
Digits 11 – Number of Refrigerant Ports (Multi-Split Systems) 2 = Two Port System 3 = Three Port System 4 = Four Port System 5 = Five Port System		
Digits 12 – Regional Markets Served (1:1 Systems) N = North America Market		
Digits 13 – Reserved for Future Use 0 = Not Currently Used		
Digits 14 – Minor Design Sequence A = First Design Sequence		
Digits 15 – Service Digit A = First Sequence		
1 of 1		

MODEL NOMENCLATURE

Parts List Number :4TXMUP2#4TXMUP2

Model Number :4TXM2242A15N0AA

Part No.	Reference No.	Quantity	Description
75011403_4TXMUP2_237742~P	*		MODEL NOMENCLATURE PARTS LIST

MODEL NUMBER DESCRIPTION	75011403	REV. A
22 SEER		
<i>Example Model Number:</i> 4TXM2218A12N0AA <small>1 - - - - 5 - - - - 10 - - - - 15</small>		
Digits 1 – Refrigerant 4 = R-410A		
Digits 2 – Brand T = Outdoor Unit		
Digits 3 – Functional Type X = Heat Pump Inverter		
Digits 4 – Configuration Outdoor Unit M = Multiple Refrigerant Ports		
Digits 5, 6 – Efficiency Tier 22 = Up To 22 SEER		
Digits 7, 8 – Nominal Capacity (Btu/h x 1,000) 18 = 18,000 Btu/h 21 = 21,000 Btu/h 24 = 24,000 Btu/h 30 = 30,000 Btu/h 36 = 36,000 Btu/h 42 = 42,000 Btu/h		
Digits 9 – Major Development Sequence A = First Development Sequence		
Digits 10 – Electric Power Supply Characteristics 1 = 208-230/60/1		
Digits 11 – Number of Refrigerant Ports (Multi-Split Systems) 2 = Two Port System 3 = Three Port System 4 = Four Port System 5 = Five Port System		
Digits 12 – Regional Markets Served (1:1 Systems) N = North America Market		
Digits 13 – Reserved for Future Use 0 = Not Currently Used		
Digits 14 – Minor Design Sequence A = First Design Sequence		
Digits 15 – Service Digit A = First Sequence		
1 of 1		

22 SEER OUTDOOR HP MULTISPLIT
2.5, 3.0 & 3.5 TON ELECTRIC BOX ASSEMBLY

75011392

REV.
A

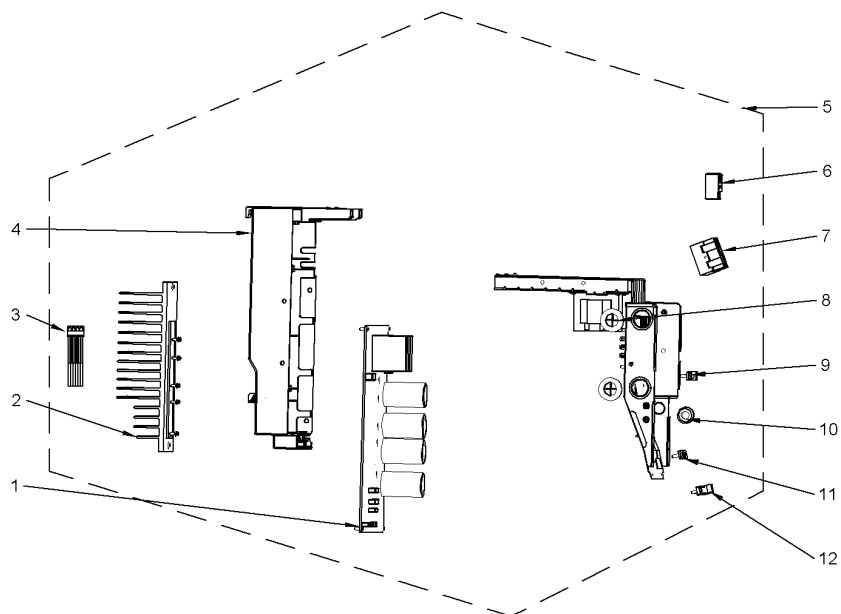

All orderable Service Parts are identified for this product.

Parts that are not identified, will not be available to order.

This is a typical illustration. The unit in the field may not appear exactly as shown.

Parts List Number :4TXMUP2#4TXMUP2

Model Number :4TXM2242A15N0AA

Part No.	Reference No.	Quantity	Description
75011392_4TXMUP2_281739~P	*		2.5, 3.0 & 3.5 TON ELECTRIC BOX ASSEMBLY PARTS LIST

22 SEER OUTDOOR HP MULTISPLIT
2.5, 3.0 & 3.5 TON ELECTRIC BOX ASSEMBLY

75011392

REV.
A

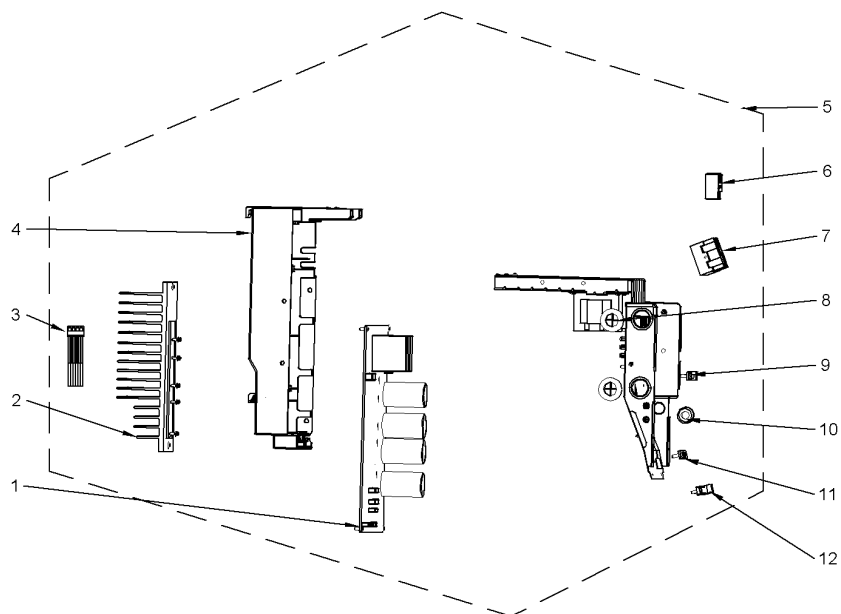

All orderable Service Parts are identified for this product.

Parts that are not identified, will not be available to order.

This is a typical illustration. The unit in the field may not appear exactly as shown.

Parts List Number :4TXMUP2#4TXMUP2

Model Number :4TXM2242A15N0AA

Part No.	Reference No.	Quantity	Description
BRD05472	1	1	BOARD; MAIN
HTR16088	2	1	HEATER; HEAT SINK
SEN02452	3	1	SENSOR; EEV LIQUID LINE SUB ASSEMBLY
BOX02890	4	1	BOX; ELECTRIC
BOX02995	5	1	BOX; ELECTRICAL ASSEMBLY (INCLUDES TERMINAL BOARD, MAIN AND CONNECTIONS)
BRD03953	6	5	BOARD; TERMINAL BOARD(420111041)
BRD05475	7	1	BOARD; INPUT TERMINAL
GKT04837	8	2	GASKET; CABLE
CMP01444	9	5	CLAMP; WIRE
RNG02311	10	4	RING; MAGNETIC
GKT04836	11	1	GASKET; INSULATION
CMP01444	12	1	CLAMP; WIRE

22 SEER OUTDOOR HP MULTISPLIT
2.0, 3.0 & 3.5 TON FAN, ELECTRIC HEATER & PANELS

75011393

REV.
A

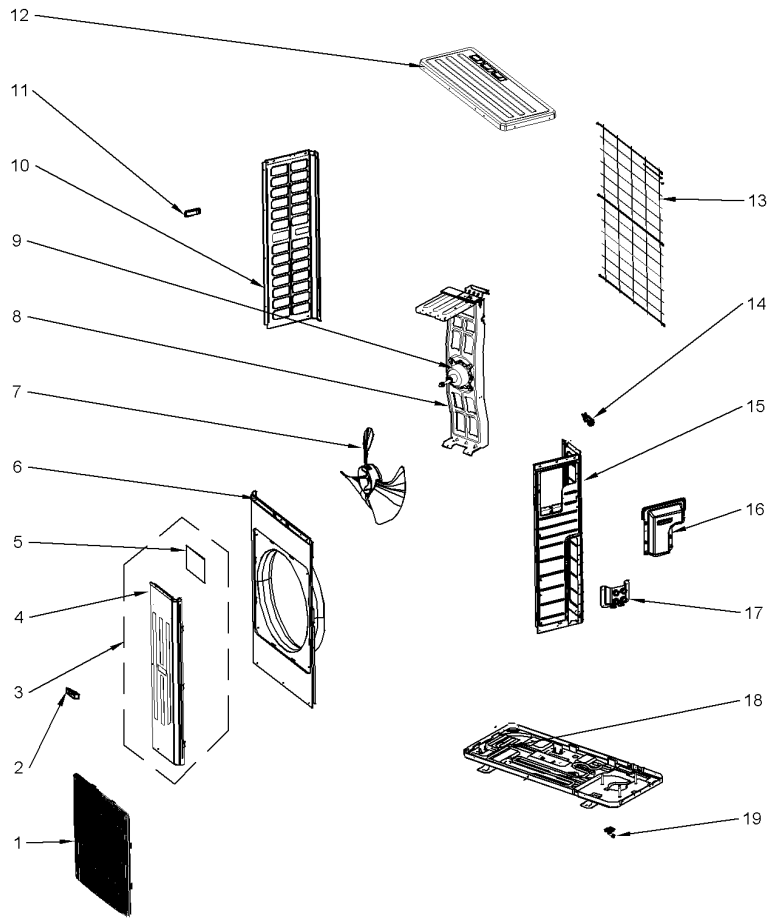

All orderable Service Parts are identified for this product.

Parts that are not identified, will not be available to order.

This is a typical illustration. The unit in the field may not appear exactly as shown.

Parts List Number :4TXMUP2#4TXMUP2

Model Number :4TXM2242A15N0AA

Part No.	Reference No.	Quantity	Description
75011393_4TXMUP2_281740~P	*		2.5, 3.0 & 3.5 TON FAN, ELECTRIC HEATER & PANELS PARTS LIST

22 SEER OUTDOOR HP MULTISPLIT
2.0, 3.0 & 3.5 TON FAN, ELECTRIC HEATER & PANELS

75011393

REV.
A

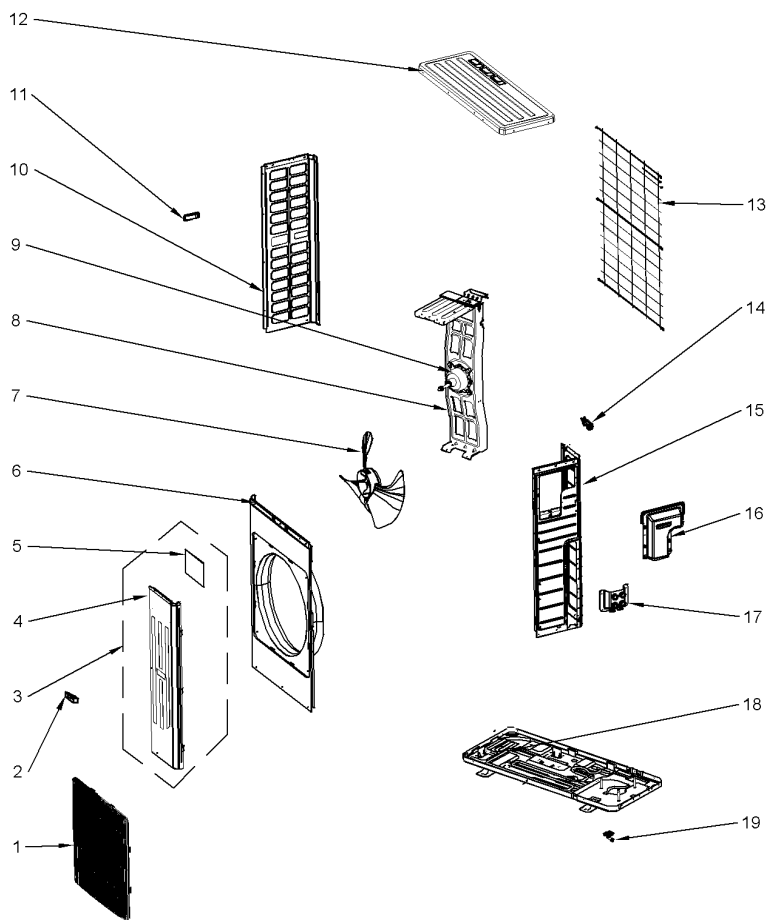

All orderable Service Parts are identified for this product.

Parts that are not identified, will not be available to order.

This is a typical illustration. The unit in the field may not appear exactly as shown.

Parts List Number :4TXMUP2#4TXMUP2

Model Number :4TXM2242A15N0AA

Part No.	Reference No.	Quantity	Description
PAI00420	*	1	PAINT; CUSTOM PAINT MATCH FOR MINI SPLIT
GRL01968	1	1	GRILLE; FRONT
HDL01102	2	1	HANDLE; HANDLE(26235253)
PLT05260	3	1	PLATE; FRONT SIDE SUB ASSY
PLT05672	4	1	PLATE; FRONT SIDE
COV05101	5	1	COVER;ELECTRIC BOX
PNL31519	6	1	PANEL; CABINET OF AIR CONDITIONER
FAN05493	7	1	FAN; AXIAL FLOW
SUP06069	8	1	SUPPORT; MOTOR
MOT17107	9	1	MOTOR; FAN
PLT05237	10	1	PLATE; LEFT SIDE PLATE OF AIR CONDITIONER
HDL01103	11	1	HANDLE; LEFT HANDLE(26235401)
PNL29977	12	1	PANEL; TOP
GRL02029	13	1	GRILL; REAR
CMP01443	14	1	CLAMP; WIRING
PNL33424	15	1	PANEL; RIGHT SIDE
COV05068	16	1	COVER; POWER TERMINAL
COV05066	17	1	COVER; WIRING
HTR16089	18	1	HEATER; BASE PAN
FTG01286	19	1	FITTING;DRAINAGE JOINT

22 SEER OUTDOOR HP MULTISPLIT
2.5, 3.0 & 3.5 TON REFRIGERATION & MISCELLANEOUS PARTS

75011394

REV.
A

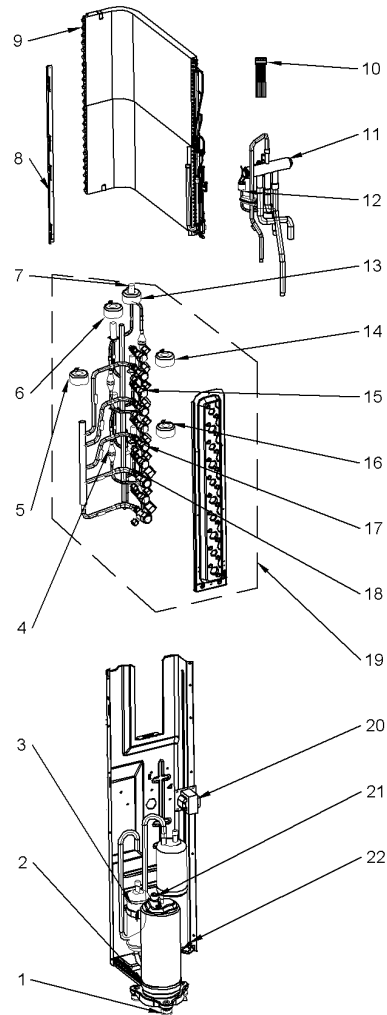

All orderable Service Parts are identified for this product.

Parts that are not identified, will not be available to order.

This is a typical illustration. The unit in the field may not appear exactly as shown.

Parts List Number :4TXMUP2#4TXMUP2

Model Number :4TXM2242A15N0AA

Part No.	Reference No.	Quantity	Description
75011394_4TXMUP2_281741~P	*		2.5, 3.0 & 3.5 TON REFRIGERATION & MISCELLANEOUS PARTS

22 SEER OUTDOOR HP MULTISPLIT
2.5, 3.0 & 3.5 TON REFRIGERATION & MISCELLANEOUS PARTS

75011394

REV.
A

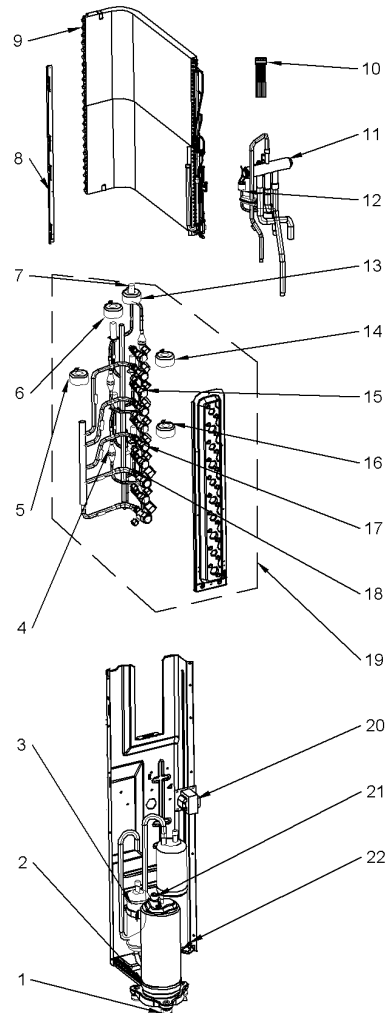

All orderable Service Parts are identified for this product.
Parts that are not identified, will not be available to order.
This is a typical illustration. The unit in the field may not appear exactly as shown.

Parts List Number :4TXMUP2#4TXMUP2

Model Number :4TXM2242A15N0AA

Part No.	Reference No.	Quantity	Description
GKT04766	1	1	GASKET; COMPRESSOR
HTR12715	2	1	HEATER; ELECTRICAL HEATER(COMPRESSOR)
COM11927	3	1	COMPRESSOR;
SRA01038	4	1	STRAINER; VALVE DRIER
MOT17282	5	1	MOTOR; EEV STEPPER (A)
MOT17280	6	1	MOTOR; EEV STEPPER (C)
VAL10704	7	1	VALVE; ELECTRONIC EXPANSION
PLT05236	8	1	PLATE; CONDENSOR COOLING SUPPORT
COL25834	9	1	COIL; CONDENSER ASSY
SEN02453	10	1	SENSOR; VAPOR TUBE ASSEMBLY
VAL12206	11	1	VALVE; 4 WAY
SWT03651	12	1	SWITCH; PRESSURE PROTECT
MOT17279	13	1	MOTOR; EEV STEPPER (D)
MOT17281	14	1	MOTOR; ELECTRIC EXPAND VALVE (EEV) FITTING
VAL09362	15	1	VALVE; CUT-OFF LIQUID
FTG01158	16	1	FITTING; ELECTRIC EXPAND VALVE FITTING, (STEPPER MOTOR)
VAL09988	17	1	VALVE; CUT-OFF VALVE
SRA01032	18	1	STRAINER; BIDIRECTION
SUP06071	19	1	SUPPORT; EEV AND CUT OFF VALVE
TRR02772	20	1	TRANSFORMER; FERRITE INDUCTOR
OLD00725	21	1	OVERLOAD; COMPRESSOR, PROTECTOR, EXTERNAL
BLT01020	22	1	BOLT;