

Part No.	Reference No.	Quantity	Description
0000090962~S	*		CABINET
0000090963~S	*		CONTROLS
0000090964~S	*		FAN
0000090961~S	*		GENERAL ASSEMBLY GRAPHIC
0000090965~S	*		HARNESS-AOC/MOC INTERFACE
0000090969~S	*		HARNESS-CL2 FIELD
0000090970~S	*		HARNESS-POWER INPUT
0000090967~S	*		HARNESS-SENSORS
0000090971~S	*		MODEL NUMBER DESCRIPTION
0000090966~S	*		OPTIONAL ACCESSORIES
0000090968~S	*		REFRIGERATION

Part No.	Reference No.	Quantity	Description
000005417~P	*		CABINET PARTS LIST

CABINET

75012536

RP
A

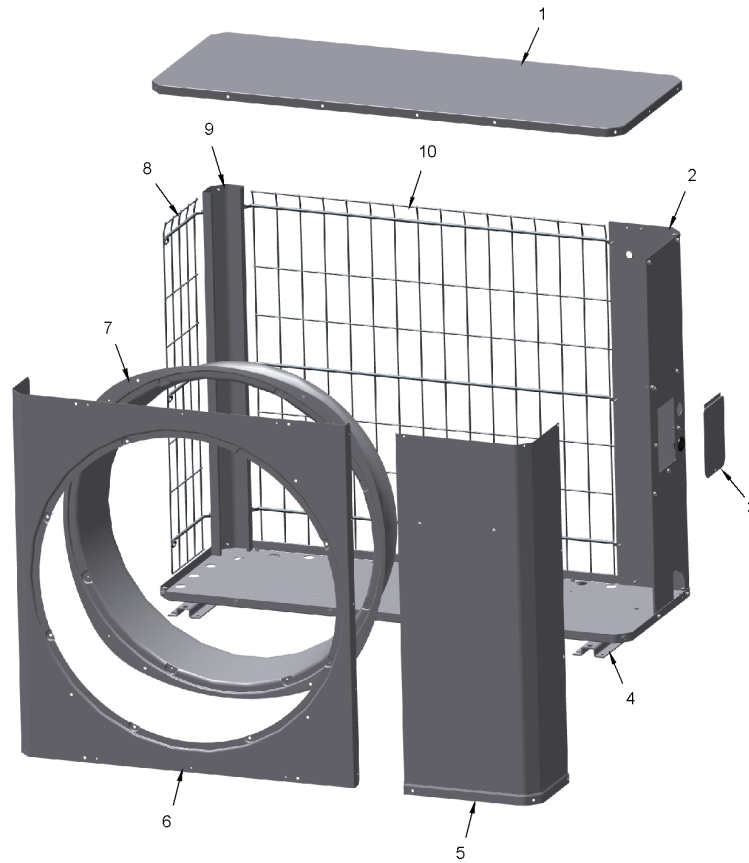

This is a typical illustration. The unit in the field may not appear exactly as shown.

Part No.	Reference No.	Quantity	Description
PAI00246	*	1	PAINT; SPRAY, TARPAULIN GRAY (SHIPPING UOM 12 OZ HAZ)
COV05328	1	1	COVER; TOP, 47.00 X 17.50
PNL35591	2	1	PANEL; SERVICE 4.4 TR
DOR04389	3	1	DOOR; SERVICE PANEL, 5.75 X 4.25
RAL01194	4	3	RAIL; BASE, 20.50 X 2.65 X 0.65
PNL34722	5	1	PANEL; ACCESS, 41.81 H
PNL35669	6	1	PANEL; FRONT, 34.62 X 42.00 X 29.70 DIA OPENING
ORF02011	7	1	ORIFICE; BASE, 39.5 ID DIA
GRL02169	8	1	GRILLE; WIRE ZLL SIDE 4.4
RAL01205	9	1	RAIL; POST-CORNER 4.4 TR
GRL02165	10	1	GRILLE; WIRE ZLL BACK 4.4

Part No.	Reference No.	Quantity	Description
0000019356~P	*		CONTROLS PARTS LIST

CONTROL PANEL

75012700

RP
A

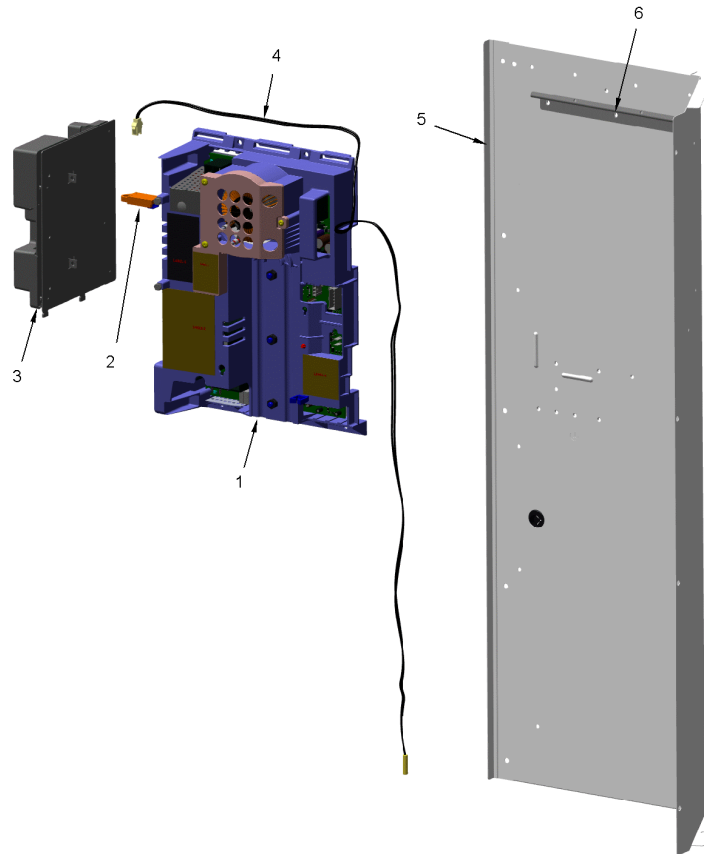

This is a typical illustration. The unit in the field may not appear exactly as shown.

Part No.	Reference No.	Quantity	Description
SCR01918	*	14	SCREW, 10-24 THREAD ROLL, INDENT HEX WASHER HD
WIR10523	*	1	WIRE; HARNESS-LSOV ASM
DRV03512	1	1	DRIVE; KIT, 6.3 KW 5T, SP
MOD01574	2	1	MODULE; TO ORDER-SEE EXT NOTE
KIT19213	3	1	KIT; VSPD AOC
SEN03020	4	1	SENSOR; AMBIENT
PNL35703	5	1	PANEL; 4.4 CONTROL PANEL-VS
RAL01209	6	1	RAIL; DRIVE

Part No.	Reference No.	Quantity	Description
000005441~P	*		FAN PARTS LIST

FAN

75012081

REV.
A

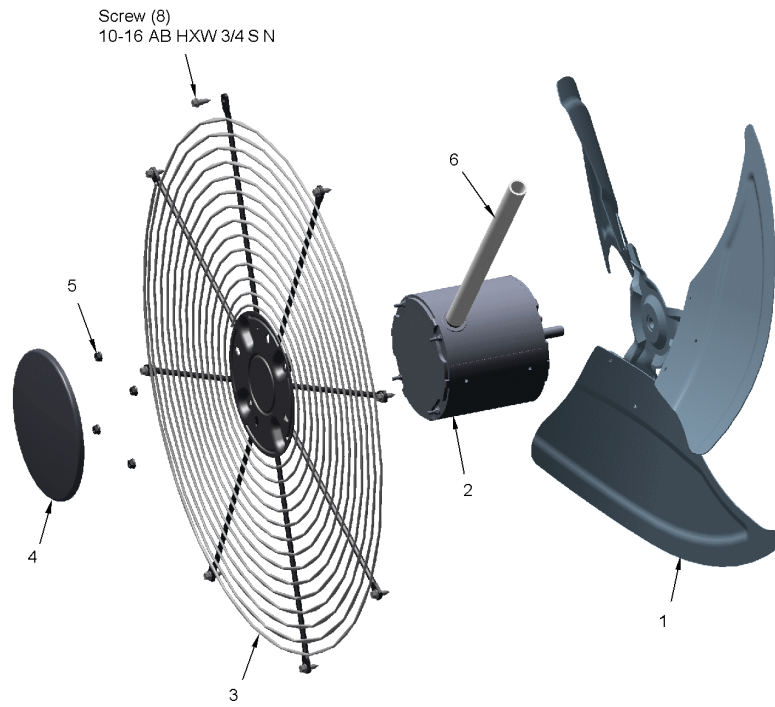

This is a typical illustration. The unit in the field may not appear exactly as shown.

Part No.	Reference No.	Quantity	Description
FAN04368	1	1	FAN, 3 SWEPT BLADE, 27.5" DIA, 26 DEG PITCH, 0.50" BORE, CCW, ALUMINUM
MOT18657	2	1	MOTOR; 1/2 HP, 200-1200 RPM, 245-385V, 3 PH, BALL BEARINGS, 48 FRAME, INCLUDES HARNESS
GRL01348	3	1	GRILLE; FAN, 29 IN DIA, SPIRAL WIRE, BASALT GREY
COV03250	4	1	COVER; MOTOR, 6.86 DIA
NUT00845	5	4	NUT; FLANGE NIBBED
GRD01633	6	1	GUARD; TROUGH-LEAD

Part No.	Reference No.	Quantity	Description
000005414~P	*		GENERAL ASSEMBLY GRAPHIC

XV19 TruComfort Low Profile Heat Pump

75012699

RP
A

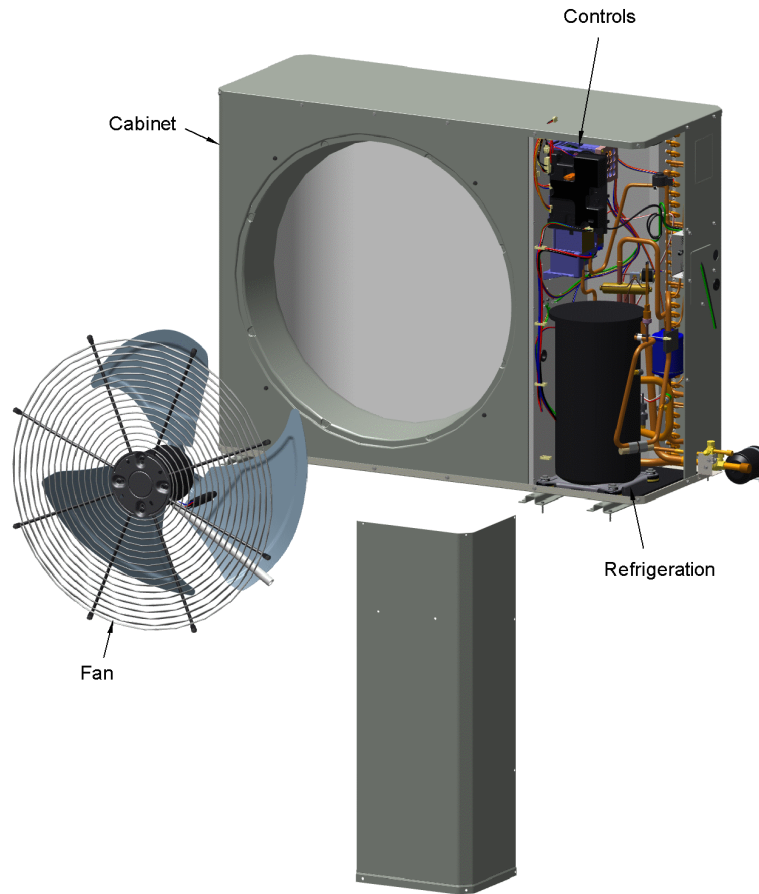

This is a typical illustration. The unit in the field may not appear exactly as shown.

Part No.	Reference No.	Quantity	Description
000005443~P	*		HARNESS-AOC/MOC INTERFACE PARTS LIST

HARNESS - AOC/MOC INTERFACE

75012727

RP
A

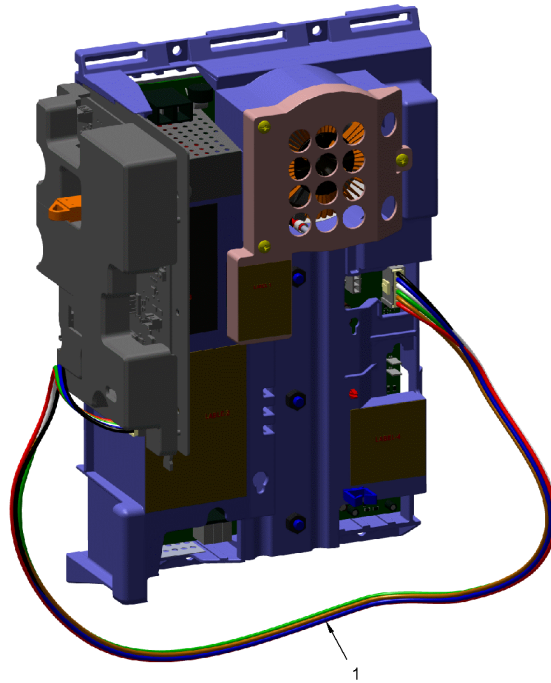

This is a typical illustration. The unit in the field may not appear exactly as shown.

Parts List Number :000090803

Model Number :4TWL9048A1000AC

Part No.	Reference No.	Quantity	Description
WIR09251		1	WIRE; HARNESS, AOC/MOC INTERFACE, 28 IN LENGTH, (2) 6 PIN PLUGS

Part No.	Reference No.	Quantity	Description
000005424~P	*		HARNESS-CL2 FIELD PARTS LIST

HARNESS - CL2 FIELD

75012728

RP
A

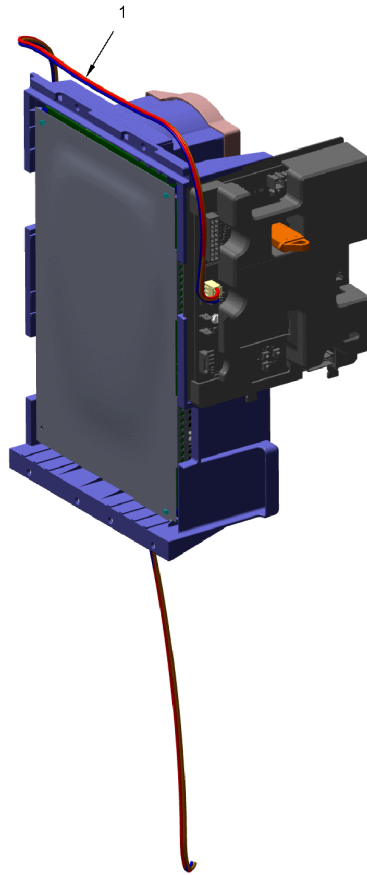

This is a typical illustration. The unit in the field may not appear exactly as shown.

Part No.	Reference No.	Quantity	Description
WIR09252	1	1	WIRE; HARNESS, CL2-FIELD, BR,RD,BL WIRES, 3 PIN PLUG, 46 IN LENGTH

Part No.	Reference No.	Quantity	Description
000005444~P	*		HARNESS-POWER INPUT PARTS LIST

HARNESS - POWER INPUT

75012725

RP
A

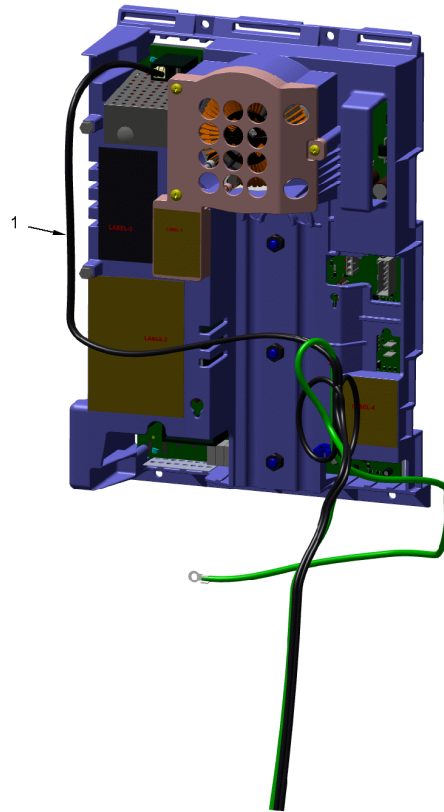

To Power Supply

This is a typical illustration. The unit in the field may not appear exactly as shown.

Parts List Number :000090803

Model Number :4TWL9048A1000AC

Part No.	Reference No.	Quantity	Description
WIR09254	1	1	WIRE; POWER - HV, MOLEX PLUG, 2 WIRES: BL/BK & BRN/RD, 30 IN LENGTH

Part No.	Reference No.	Quantity	Description
000005445~P	*		HARNESS-SENSORS PARTS LIST

HARNESS - SENSORS

75012726

RP
A

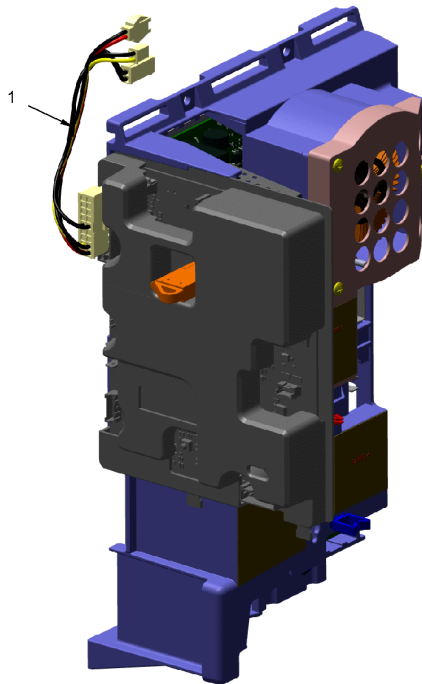

This is a typical illustration. The unit in the field may not appear exactly as shown.

Part No.	Reference No.	Quantity	Description
WIR09253	1	1	WIRE; SENSORS, 12 WIRES, 18 PIN PLUG, 5 IN LENGTH, TO CBS, DTS, ODS, STS, SP-TRD

Part No.	Reference No.	Quantity	Description
000005415~P	*		MODEL NUMBER DESCRIPTION

MODEL NUMBER DESCRIPTION

75005586

REV
D

OUTDOOR UNITS

Example Model Number:

4 TWV 00 3 6 A 1 0 0 0 A A
1 - - - 5 - - - 10 - - - 15

Digit 1 – Refrigerant Type

2 = R-22
4 = R-410A

Digit 2 – Trane

Digit 3 – Product Type

W = Split Heat Pump
T = Split Cooling

Digit 4 – Product Family

V = Variable Speed
Z = Leadership - Two Stage
X = Leadership
R = Replacement/Retail
M or B = Basic
A = Light Commercial
L = Side Discharge

Digit 5 – Family SEER

3 = 13 7 = 17
4 = 14 9 = 19
5 = 15 9 = 19
6 = 16 0 = 20

Digits 6 – Split System Connections 1-6 Tons

0 = Brazed

Digits 7,8 – Nominal Capacity in 000s BTUs

Digit 9 – Major Design Modifications

Digit 10 – Power Supply

1 = 200-230/1/60 or 208-230/1/60
3 = 200-230/3/60
4 = 460/3/60

Digit 11,12,13 – Secondary Function

Digit 14 – Minor Design Modifications

Digit 15 – Unit Parts Identifier

Part No.	Reference No.	Quantity	Description
000005447~P	*		OPTIONAL ACCESSORIES LIST

Part No.	Reference No.	Quantity	Description
BAYISLT101	*	1	KIT; ISOLATOR (BAYISLT101) (CONTAINS A QTY OF 5 ISOLATORS)
BAYLEGS004	*	1	KIT; SNOW LEGS, CONTAINS (4) 4" MOUNTING LEGS
BAYLEGS007	*	1	KIT; SNOW LEGS, CONTAINS (4) 7" MOUNTING LEGS
BAYWIND101	*	1	WIND BAFFLE ASM
BRK05033	*	1	BRACKET; LARGE WALL BRACKET WITH RAIL AND 3 ARMS UP TO 350 LBS
PAI00309	*	1	PAINT; DARK BROWN, 12 OZ SPRAY CAN, HERESITE AIR DRY PHENOLIC COATING, VR-554T

Part No.	Reference No.	Quantity	Description
000005450~P	*		REFRIGERATION PARTS LIST

REFRIGERATION

75012698

RP
A

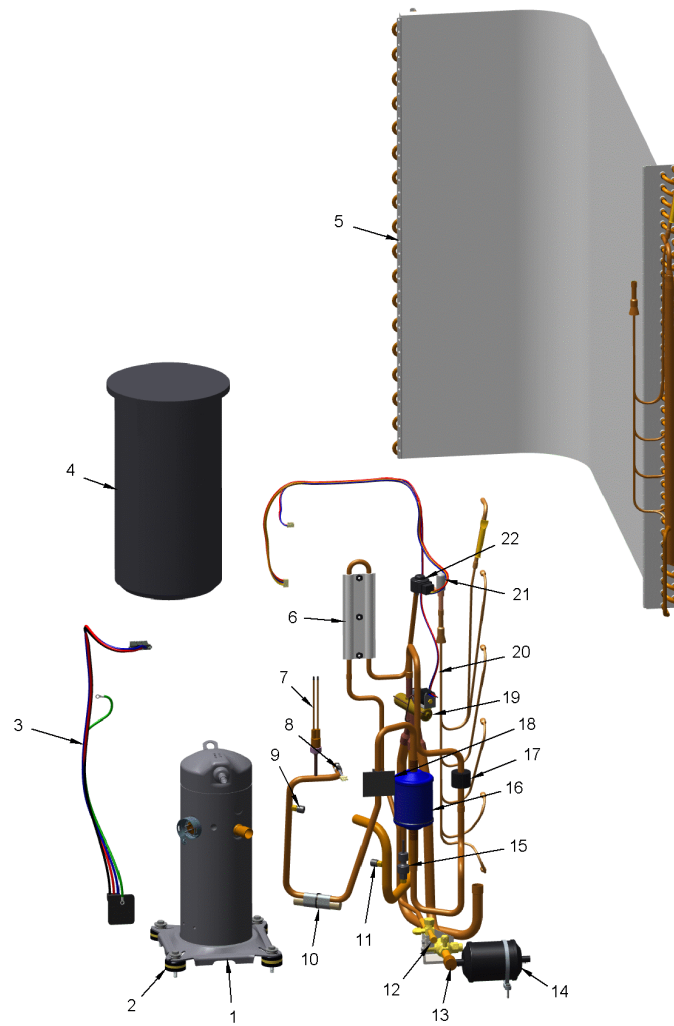

This is a typical illustration. The unit in the field may not appear exactly as shown.

Part No.	Reference No.	Quantity	Description
SEN03002	*	1	SENSOR; SUCTION LINE
SEN03005	*	1	SENSOR; COIL
COM11949	1	1	COMPRESSOR; SCROLL; DRIVE CONTROLLED; CAA041C1CPA; 3.5 TON; 208V-60-1; R410-A; SUCTION 3/4; DISCHARGE 1/2
SCR01914	2	4	SCREW, ASSEMBLY COMPRESSOR, 5/16-12 TYPE B, W/WASHER & SLEEVE
PLU01326	3	1	PLUG; SCROLL COMPRESSOR, 12 AWG, BK,RD,BL WIRES, 45 IN LENGTH
ATT00520	4	1	ATTENUATOR; NOISE ENCLOSURE
COL28858	5	1	COIL; OUTDOOR, PLATE FIN
CMP01596	6	1	CLAMP; CLAMPING PLATE
SWT04180	7	1	SWITCH; HIGH PRESSURE, BRAZED, SPST, OPEN AT 650 PSIG, CLOSE AT 500 PSIG, 32 IN WHITE YELLOW LEADS
SEN02713	8	1	SENSOR; DISCHARGE
BOD00114	9a	1	BODY; VALVE, BRASS, 7/16 HEX, 7/16 -20 UNF-2A
CAP00455	9b	1	CAP; HUB, 7/16-20 STRAIGHT
COR00103	9c	1	CORE; VALVE, .79 LENGTH, .206-36 UNS-1 MOD. THD
BAR00178	10a	1	BAR; STEEL, 3.70 X .75 DIA
CLP00200	10b	2	CLIP; BULB
BOD00114	11a	1	BODY; VALVE, BRASS, 7/16 HEX, 7/16 -20 UNF-2A
CAP00455	11b	1	CAP; HUB, 7/16-20 STRAIGHT
COR00103	11c	1	CORE; VALVE, .79 LENGTH, .206-36 UNS-1 MOD. THD
VAL09293	12a	1	VALVE, SERVICE LIQUID, .38 OD X .38 OD, VALVE ASSY
CAP01336	12b	1	CAP; SERVICE LIQUID VALVE, BRASS, 0.75 OD X 0.57 ID X 11/16- 28UN-2B
VAL11774	13a	1	VALVE; SERVICE GAS ASSEMBLY, 0.88 ODS X 0.88 ODS, WITH 0.25 SAE SERVICE PORT SERVICE
CAP01412	13b	1	CAP; SERVICE VALVE, BRASS, 1.00 OD X 0.57 ID X M18 X 1-6H
DHY01452	14	1	DRIER; BI-FLOW; SERVICE FIRST; 16 CU. IN; DCB163S, 3/8 ODF CONNECTIONS; 5.7 TON CAPACITY; APPROVED FOR MINERAL OIL AND POE OIL REFRIGERANTS; MANUFACTU
TDR00732	15a	1	TRANSDUCER; PRESSURE, SUCTION, 0.5 VDC AT 14.7 PSIA, 4.5 VDC AT 400 PSIA, 1/4" SAE FEMALE FLARE WITH DEFLATOR, 7/16-20 UNF-2B 5/8 ACROSS FLATS, 48 IN
BOD00114	15b	1	BODY; VALVE, BRASS, 7/16 HEX, 7/16 -20 UNF-2A
MFL00816	16	1	MUFFLER; 1/2 ODF CONNECTION, 6.45 X 4.55, (PAINTED DARK BLUE)
GRM01080	17	1	GROMMET; RUBBER BLOCK
SPC00388	18	1	SPACER; TUBE
VAL11214	19	1	VALVE; SWITCHOVER, 6 TON, 0.875 IDF X 0.625 OD, W/ 12 DCV SOLENOID COIL
WIR07180	20	1	WIRE; HARNESS-SWITCHOVER VALVE SOLENOID, (2) 2-PIN CONNECTORS, RED & BLUE WIRES, 35 INCH LENGTH, TO J17
VAL11171	21	1	VALVE; EEV, 2.0 MM, FOR 5 TON
COL15628	22	1	COIL; MOTOR ASM-EEV, STATOR (SC)