

Part No.	Reference No.	Quantity	Description
75010728#4PXAUP1~S	*		COIL CABINET
75010724#4PXAUP1~S	*		COIL
4PXA_4PXAUP1_123349~P	*		HIGH EFFICIENCY COIL PARTS LIST
75010729#4PXAUP1~S	*		MODEL NUMBER DESCRIPTION
OPTION#4PXAUP1~S	*		OPTIONAL KITS

NO GRAPHIC AVAILABLE

75013702

REV
A

**NO
GRAPHIC
AVAILABLE**

HIGH EFFICIENCY COIL

75010724

REV.
A

TYPICAL ILLUSTRATION

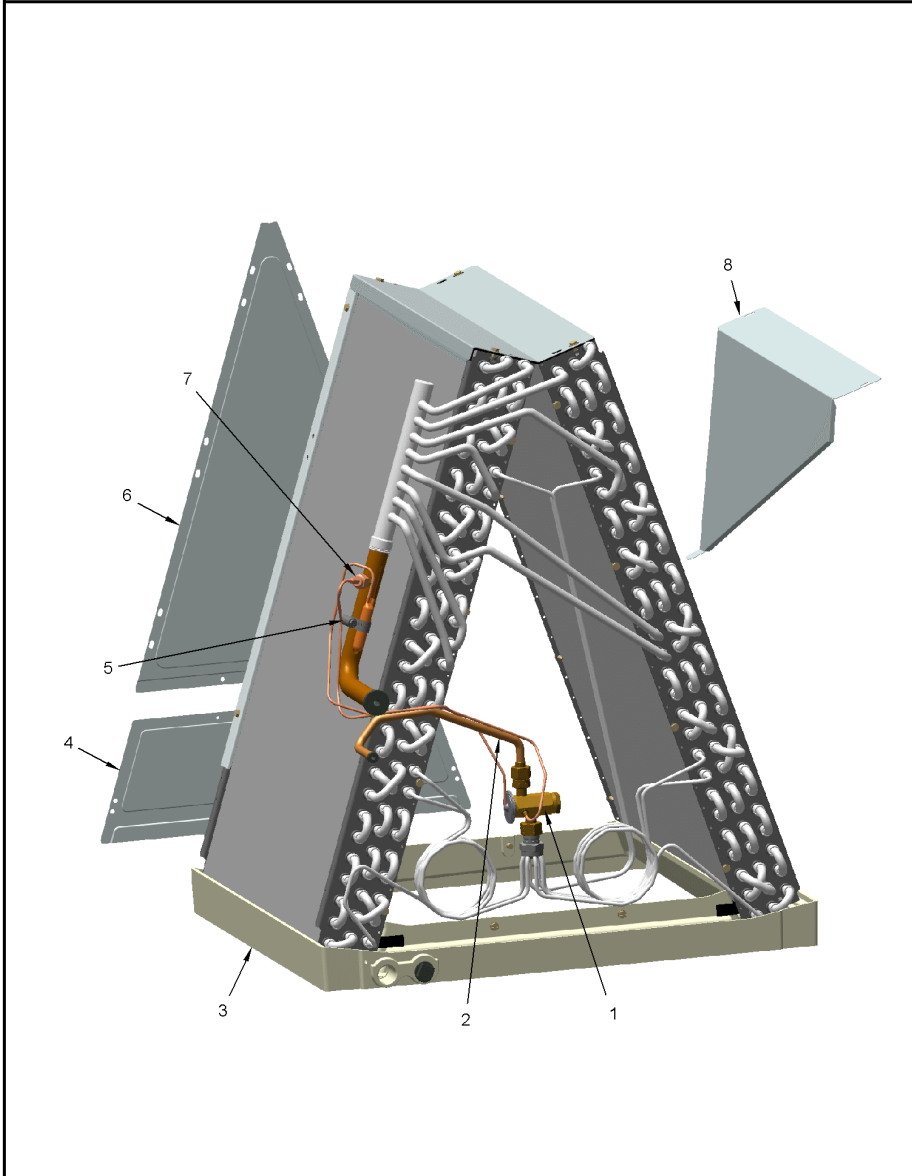

Part No.	Reference No.	Quantity	Description
75010724_4PXAUP1_322136~P	*		COIL PARTS LIST

HIGH EFFICIENCY COIL

75010724

REV.
A

TYPICAL ILLUSTRATION

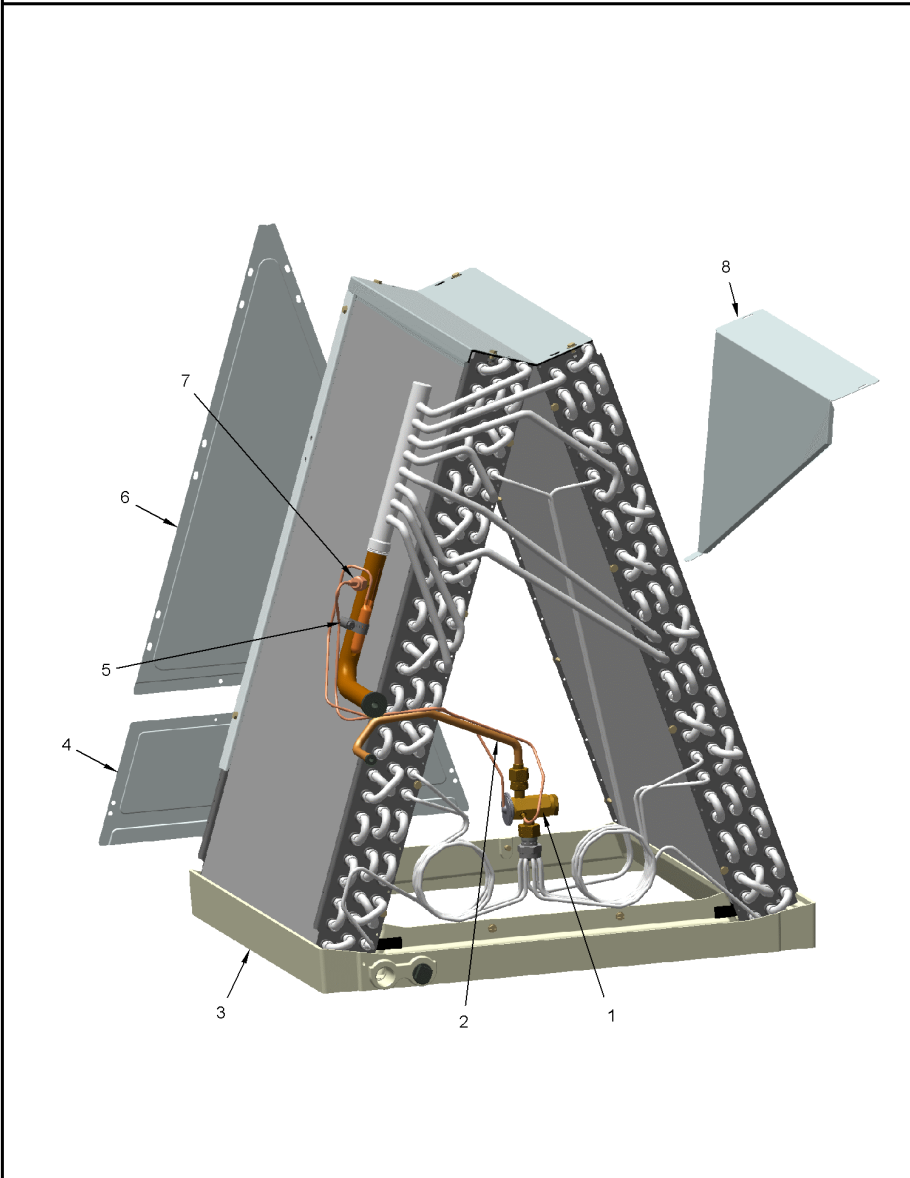

Part No.	Reference No.	Quantity	Description
SCR00965	*	28	SCREW, 10-16 AB HXW 1/2 S N
SCR00969	*	4	SCREW;10-16 BT HXW 5/8 S
VAL12309	1	1	VALVE; TXV CHATLEFF, 6 TON, 79 PSIG OUTLET AT 32F, 15 PERCENT BLEED
TUB13777	2	1	TUBE; ASSEMBLY, LIQUID. INCLUDES FLANGE FITTING, HEX NUT AND INLET SCREEN
PAN03217	3	1	PAN; DRAIN PAN ASSEMBLY, PLASTIC,19.78 X 21.10 X 2.54
PLT05394	4	2	PLATE; COIL BAFFLE-LOWER, 14.00 L X 5.50 H
CMP01450	5	1	CLAMP; HOSE, 11/16 - 1-1/4, 1/2 W, 5/16 HEX SCREW, STAINLESS STEEL
PLT05407	6	2	PLATE; COIL BAFFLE, TOP, 11.04 W X 17.40 H
BOD00114	7	1	BODY; VALVE, BRASS, 7/16 HEX, 7/16 -20 UNF-2A
BAF01223	8	1	BAFFLE; TOP, 17.88 X 10.00 X 2.00 TRIANGULAR GALVANIZED SHEET METAL

COIL CABINET

75010728

REV.
A

TYPICAL ILLUSTRATION

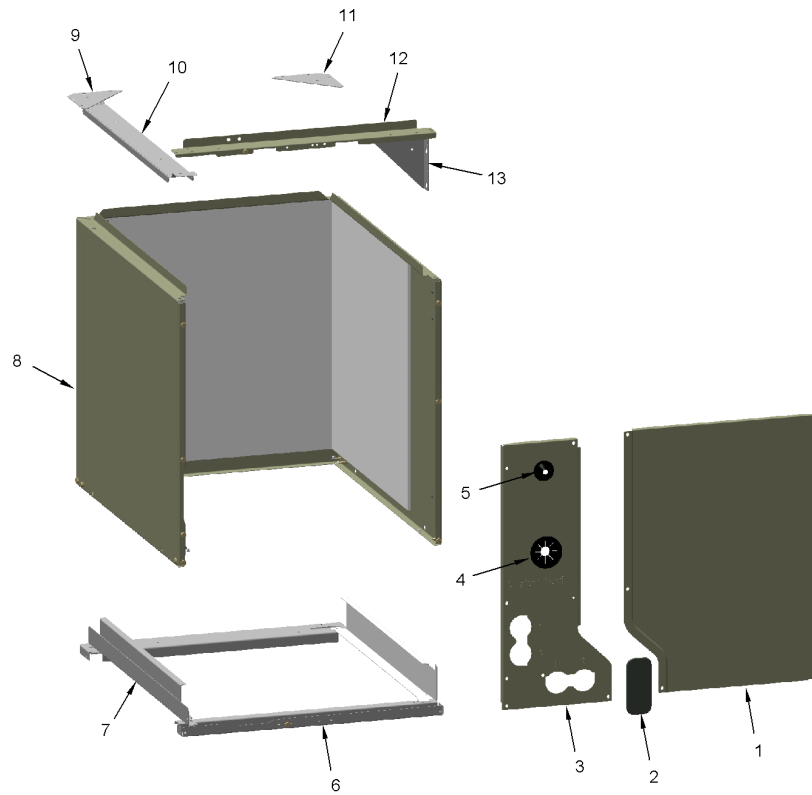

COIL CABINET

Parts List Number :4PXA#4PXAUP1

Model Number :4PXCCU48BS3HAAA

Part No.	Reference No.	Quantity	Description
75010728_4PXAUP1_211858~P	*		COIL CABINET PARTS LIST

COIL CABINET

75010728

REV.
A

TYPICAL ILLUSTRATION

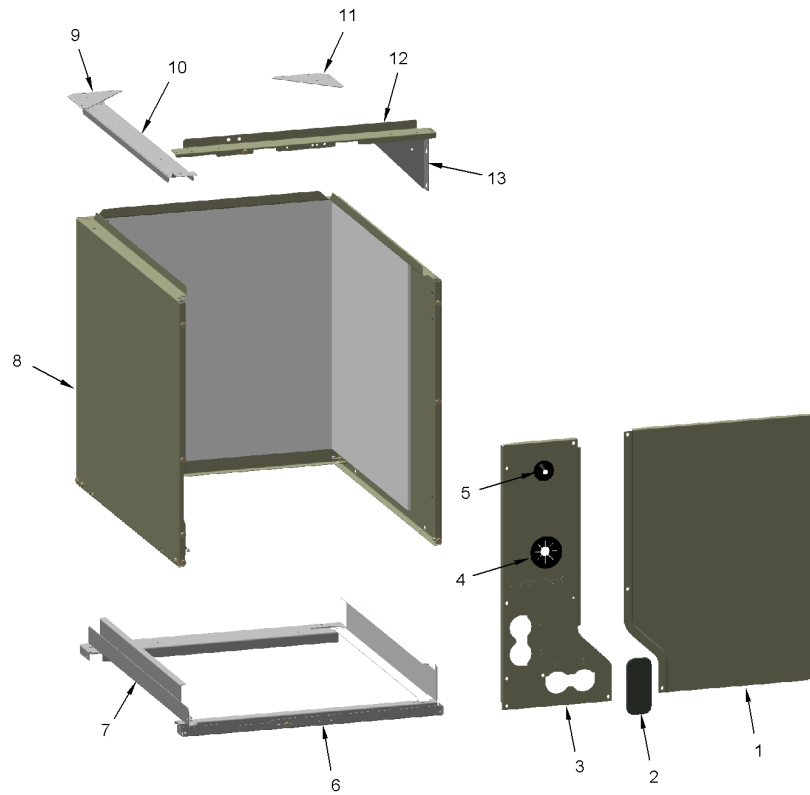

Part No.	Reference No.	Quantity	Description
INS02507	1	1	INSULATION; FRONT
PNL21803	1	1	PANEL; RIGHT FRONT WITH INSULATION, 26.65 X 16.60. FOR PANEL ONLY ORDER PNL17604.
PLU01264	2	1	PLUG; PANEL PLUG, BLACK, 3.71 X 1.66
PNL31867	3	1	PANEL; MANIFOLD, 26.59 X 7.15, INCLUDES (1) GRM00863 & (1) GRM00864
GRM00863	4	1	GROMMET; SUCTION GROMMET
GRM00864	5	1	GROMMET; CONE GROMMET, LIQUID LINE
SUP04115	6	1	SUPPORT; ANGLE, 20.94 X 13.75 X 0.80
ANG01172	7	1	ANGLE;
PNL20190	8	1	PANEL; WRAPPER, 21.36 L X 21.00 W X 26.75 H, W/O INSULATION
BRK01730	9	1	BRACKET;
ANG00695	10	1	ANGLE;
BRK01730	11	1	BRACKET;
CNL00442	12	1	CHANNEL;
BRK01706	13	1	BRACKET;ANGLE ASSEMBLY

MODEL NUMBER DESCRIPTION

75010729

REV.
A

Heat Pump / Cooling Coils

Example Model Number:

4 T X C B 0 3 6 A C 3 H C A A
1 - - - 5 - - - 10 - - - 15

Digit 1 – Refrigerant Type

4 = R-410A

Digit 2 – Series

T = Premium (Heat Pump)
N = Premium (Cooling and HP)
P = Premium High Efficiency - Dedicated
position (Cooling and HP)
C = Standard (Cooling Only)
F = Entry Level (Cooling Only)

Digit 3 – Coil Design

X = Direct Expansion Evaporator Coil

Digit 4 – Coil Feature

C = Cased A Coil
A = Uncased A Coil
F = Cased Horizontal Flat Coil

Digit 5 – Coil Width (Cased/Uncased)

A = 14.5" / 13.3"
B = 17.5" / 16.3"
C = 21.0" / 19.8"
D = 24.5" / 23.3"
H = 10.5"

Digit 6 – Refrigerant Line Coupling / Airflow Configuration

0 = Brazed
U = Upflow only, convertible to Horizontal Left
D = Downflow only, convertible to Horizontal
Right

Digits 7,8 – Nominal Capacity in 1000's (BTUH) / Model Number Distinguisher

Digit 9 – Major Design Change

Digit 10 – Efficiency

C = Standard
S = High Efficiency (derived from 10 SEER
products)
Z = High Efficiency (TXV modulates to 50%)

Digit 11 – Refrigerant Control

3 = TXV - Non-Bleed

Digit 12 – Coil Circuitry

H = Heat Pump
C = Cooling

Digit 13 – Airflow Configuration

A = Upflow
U = Upflow / Downflow
D = Downflow
R = Downflow / Horizontal Right
H = Horizontal Left / Right
C = Convertible - Upflow, Downflow,
Left or Right

Digit 14 – Minor Design Change

Digit 15 – Service Digit, Not Orderable

Part No.	Reference No.	Quantity	Description
75010729_4PXAUP1_123354~P	*		MODEL NUMBER DESCRIPTION PARTS LIST

MODEL NUMBER DESCRIPTION

75010729

REV.
A

Heat Pump / Cooling Coils

Example Model Number:

4 T X C B 0 3 6 A C 3 H C A A
1 - - - 5 - - - 10 - - - 15

Digit 1 – Refrigerant Type

4 = R-410A

Digit 2 – Series

T = Premium (Heat Pump)
N = Premium (Cooling and HP)
P = Premium High Efficiency - Dedicated
position (Cooling and HP)
C = Standard (Cooling Only)
F = Entry Level (Cooling Only)

Digit 3 – Coil Design

X = Direct Expansion Evaporator Coil

Digit 4 – Coil Feature

C = Cased A Coil
A = Uncased A Coil
F = Cased Horizontal Flat Coil

Digit 5 – Coil Width (Cased/Uncased)

A = 14.5" / 13.3"
B = 17.5" / 16.3"
C = 21.0" / 19.8"
D = 24.5" / 23.3"
H = 10.5"

Digit 6 – Refrigerant Line Coupling / Airflow Configuration

0 = Brazed
U = Upflow only, convertible to Horizontal Left
D = Downflow only, convertible to Horizontal
Right

Digits 7,8 – Nominal Capacity in 1000's (BTUH) / Model Number Distinguisher

Digit 9 – Major Design Change

Digit 10 – Efficiency

C = Standard
S = High Efficiency (derived from 10 SEER
products)
Z = High Efficiency (TXV modulates to 50%)

Digit 11 – Refrigerant Control

3 = TXV - Non-Bleed

Digit 12 – Coil Circuitry

H = Heat Pump
C = Cooling

Digit 13 – Airflow Configuration

A = Upflow
U = Upflow / Downflow
D = Downflow
R = Downflow / Horizontal Right
H = Horizontal Left / Right
C = Convertible - Upflow, Downflow,
Left or Right

Digit 14 – Minor Design Change

Digit 15 – Service Digit, Not Orderable

OPTIONAL KITS

Parts List Number :4PXA#4PXAUP1

Model Number :4PXCCU48BS3HAAA

Part No.	Reference No.	Quantity	Description
OPTION_4PXAUP1_174455-P	*		OPTIONAL KITS PARTS LIST

NO GRAPHIC AVAILABLE

75013702

REV
A

**NO
GRAPHIC
AVAILABLE**

Part No.	Reference No.	Quantity	Description
2AYTXVH3H4248A	*	1	KIT; FIELD MOUNTED TXV (R-22)
BAYCONV27A	*	1	KIT; HORIZONTAL CONVERSION, 4PXC COILS
BAYGSKT001A0	*	1	KIT-DOWNFLOW INSULATE GSK