

Parts List Number :0000145317

Model Number :4MXD2321A10N0AA

Part No.	Reference No.	Quantity	Description
0000145340~S	*		Electric Box and Seal Plate
0000145387~S	*		Evaporator Assembly
0000145341~S	*		General Assembly
0000145320~S	*		Model Number Description

Part No.	Reference No.	Quantity	Description
0000024917~P	*		Ducted 18,21,24k - Electric Box and Seal Plate Assembly

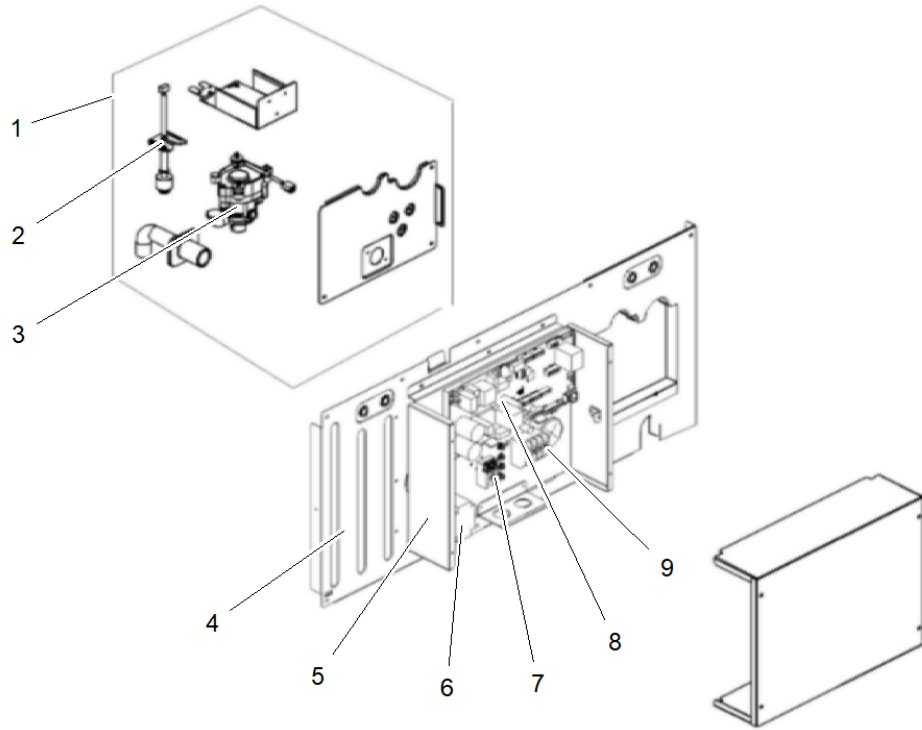

Part No.	Reference No.	Quantity	Description
PLT07064	1	1	PLATE; SEAL ASM
SWT04579	2	1	SWITCH; WATER LEVEL
PNP02384	3	1	PUMP; WATER
PLT07063	4	1	PLATE; LEFT SIDE ASM
BOX04382	5	1	BOX; ELECTRIC ASM
BRD07674	8	1	BOARD; MAIN
BRD07667	9	1	BOARD; TERMINAL

Part No.	Reference No.	Quantity	Description
0000024916~P	*		Ducted 18,21,24k - Evaporator Assembly

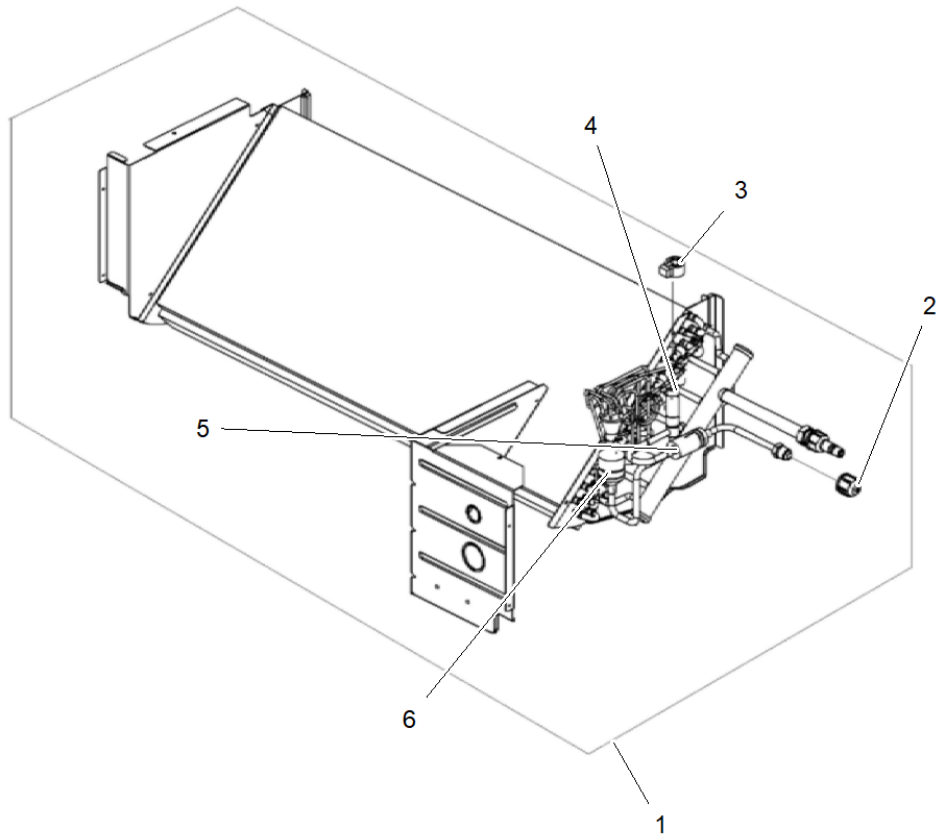

Part No.	Reference No.	Quantity	Description
EVP02886	1	1	EVAPORATOR; ASM
CAP01434	2	1	CAP; SEALING - PRESSURE WARNING

Part No.	Reference No.	Quantity	Description
0000024918~P	*		Ducted 18,21,24k - General Assembly

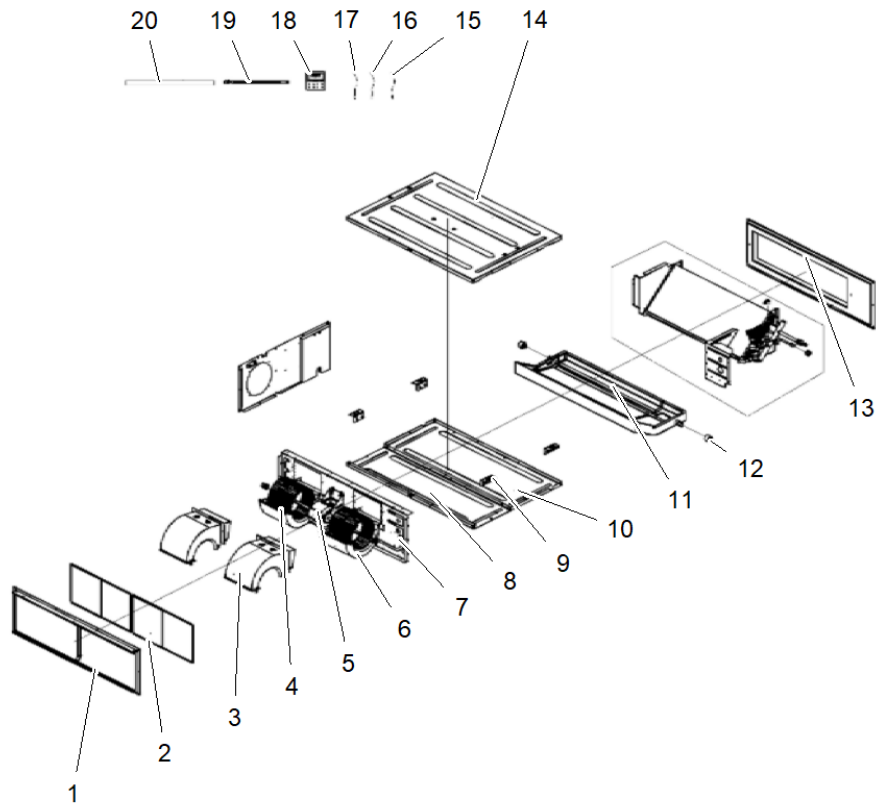

Part No.	Reference No.	Quantity	Description
SUP06889	1	1	SUPPORT; RETURN AIR FRAM SUB ASM
FLR09271	2	2	FILTER; SUB ASM
HUS04429	3	2	HOUSING; PROPELLER UPPER
FAN06475	4	2	FAN; CENTRIFUGAL
MOT20134	5	1	MOTOR; BRUSHLESS DC
HUS04430	6	2	HOUSING; PROPELLER LOWER
PLT07065	7	1	PLATE; BLOWER MOUNTING SUB ASM
COV06088	8	1	COVER; OF AIR-IN
BRK04556	9	4	BRACKET; HOOK
PLT07066	10	1	PLATE; BOTTOM COVER
PNL38290	11	1	PANEL; FOAM SUB ASM
PIP03389	12	2	PIPE; CHOKE PLUG OF DRAIN
SUP06890	13	1	SUPPORT; AIR OUTLET FRAME ASM
BRD07676	14	1	BOARD; TOP COVER ASM
SEN02280	16	1	SENSOR; TEMPERATURE
SEN01333	17	1	SENSOR; AMBIENT TEMPERATURE (390000451)
BRD07673	18	1	BOARD; DISPLAY
PIP03390	19	1	PIPE;
HSE01875	20	1	HOSE; DRAIN SUB-ASSY

Part No.	Reference No.	Quantity	Description
0000024885~P	*		Model Number Description

MODEL NUMBER DESCRIPTION	75014679	REV A
Multi Split IDU Update		
<i>Example Model Number:</i> 4MX6512A10N0BA 1 - - - 5 - - - - 10 - - - - 15		
Digit 1 – Refrigerant 4 = R-410A	Digit 13 – Reserved for Future Use 0 = Not Currently Used	
Digit 2 – Unit Type M = Indoor Unit U = Pro Series	Digit 14 – Minor Design Sequence A,B,C, etc. = Minor Design Sequence	
Digit 3 – Function Type X = Heat Pump Inverter Y = Cooling Only Inverter	Digit 15 – Service Digit A,B,C,etc. = Service Digit Sequence	
Digit 4 – Configuration Indoor Unit W = High Wall Unit D = Ceiling Concealed Unit C = Cassette Unit F = Floor Console Unit X = Convertible (Floor/Ceiling) Mount L = Cassette Panel Cover		
Digit 5,6 – Efficiency Tier 16 = 16 SEER 65 = 16 SEER 85 = 18 SEER 20 = up to 22 SEER Pro Series 22 = up to 22 SEER 27 = up to 27 SEER		
Digit 7,8 – Nominal Capacity 09 = 9,000 Btu/h 30 = 30,000 Btu/h 12 = 12,000 Btu/h 36 = 36,000 Btu/h 18 = 18,000 Btu/h 42 = 42,000 Btu/h 21 = 21,000 Btu/h 48 = 48,000 Btu/h 24 = 24,000 Btu/h		
Digit 9 – Major Development Sequence A, B, C, etc. = Major Development Sequence		
Digit 10 – Electric Power Supply Characteristics 1 = 208-230/60/1 L = 115/60/1		
Digit 11 – Reserved for Future Use 0 = Not Currently Used		
Digit 12 – Regional Markets Served (1:1 Systems) N = North America Market		
		1 of 1

