

Part No.	Reference No.	Quantity	Description
0000156173~S	*		CABINET
0000168308~S	*		COMPRESSOR
0000156172~S	*		CONTROLS
0000156171~S	*		FAN
0000156169~S	*		GENERAL ASSEMBLY
0000156170~S	*		REFRIGERATION

Part No.	Reference No.	Quantity	Description
0000030399~P	*		CABINETRY PARTS LIST

CABINETY

75006805

REV
A

Typical Illustration. Unit may not appear exactly as shown.

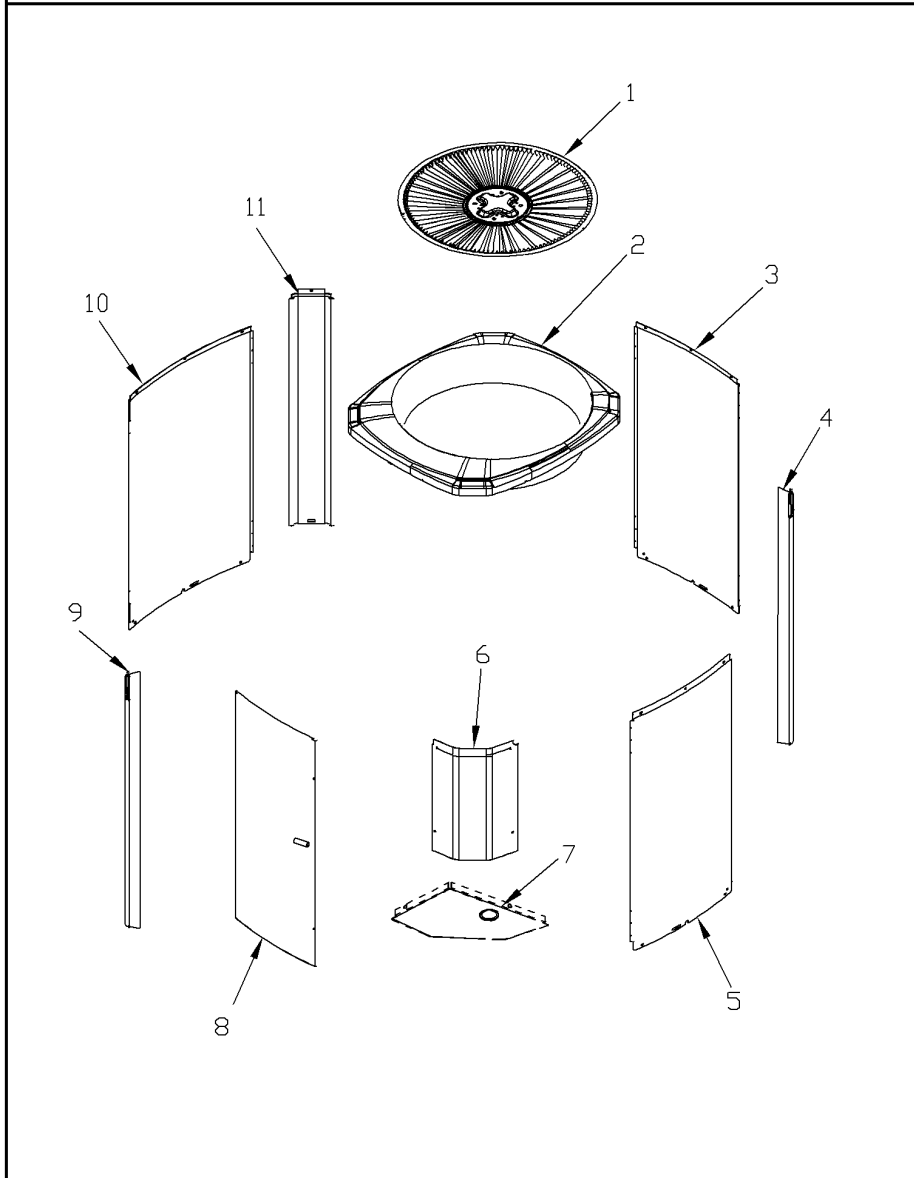

Part No.	Reference No.	Quantity	Description
BAS02187	*	1	BASE; 31.31 X 31.49 DIAGONALLY
PAI00074	*	0	PAINT; SPRAY, SLATE GREY, FULL GLOSS(88) (SHIPPING UOM 12 OZ HAZ)
PAI00207	*	0	PAINT; SPINNAKER GRAY (SHIPPING UOM 12 OZ HAZ) SPRAY CAN
SCR02010	*	18	SCREW; 12-18 AB HXW 1/2 SN
SCR02054	*	18	SCREW; 12-18 AB HXW 1/2 SN
COV04884	2	1	COVER; TOP, 28.13 X 25.40
PNL14792	3	1	PANEL; WRAPPER, 19.55 X 25.33
PNL26276	4	1	PANEL; CORNER POST, 3.5 x 25.3
PNL14792	5	1	PANEL; WRAPPER, 19.55 X 25.33
COV04883	6	1	COVER; CONTROLS, 16.18 X 11.00
COV03287	7	1	COVER; CONTROL BOTTOM
PNL14794	8	1	PANEL; ACCESS, 12.02 X 24.65
PNL26276	9	1	PANEL; CORNER POST, 3.5 x 25.3
PNL14793	10	2	PANEL; WRAPPER, 16.29 X 25.33
PNL26276	11	1	PANEL; CORNER POST, 3.5 x 25.3

Part No.	Reference No.	Quantity	Description
0000037397~P	*		COMPRESSOR PARTS LIST

Part No.	Reference No.	Quantity	Description
COM11996		1	COMPRESSOR; SCROLL; LG; LBA020C1CLA; 1.75 TON; 19,500 BTUH; 208/230-60-1; R-410A; BRAZED; SUCTION 3/4; DISCHARGE 1/2

CONTROLS

Parts List Number :0000156154

Model Number :4A7A4018N1000AA

Part No.	Reference No.	Quantity	Description
0000030357~P	*		CONTROLS-COOLING

CONTROLS

75010701

REV
A

TYPICAL ILLUSTRATION

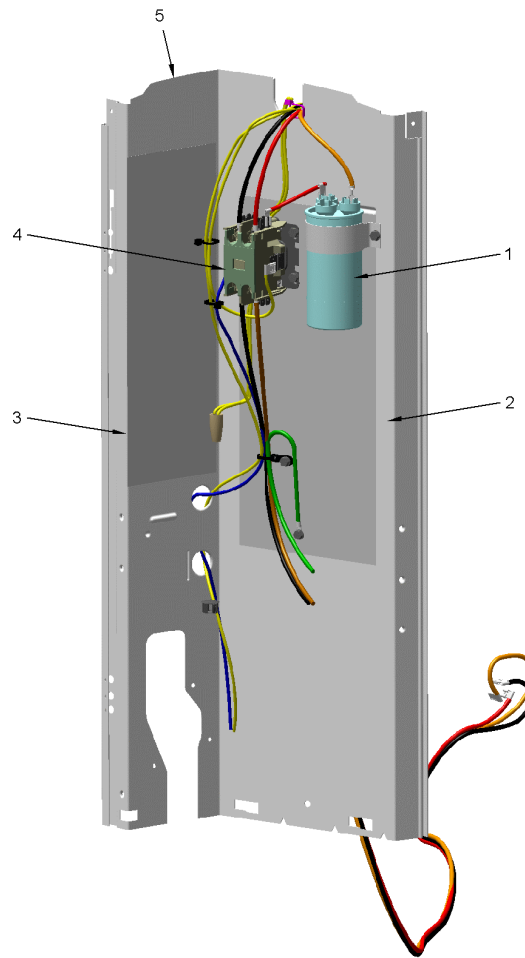

Part No.	Reference No.	Quantity	Description
CON00241	*	1	CONNECTOR; WIRE
PAI00246	*	0	PAINT; SPRAY, TARPAULIN GRAY (SHIPPING UOM 12 OZ HAZ)
PLU00984	*	1	PLUG; LOCKING HOLE
PLU01293	*	1	PLUG; SCROLL COMPRESSOR
SCR01918	*	5	SCREW, 10-24 THREAD ROLL, INDENT HEX WASHER HD
SRP00269	*	1	STRAP; CAPACITOR
TER00312	*	1	TERMINAL; 8IN. TIE CABLE
TIE00007	*	1	TIE;CABLE
CPT00977	1	1	CAPACITOR; DUAL, 35/5 MFD, 440V, ROUND, W/O RESISTOR
SHD00386	2	1	SHIELD; MOISTURE, 12.75 X 5.00
SHD00387	3	1	SHIELD; MOISTURE, 10.25 X 4.00
CTR02579	4	1	CONTACTOR; 1P 30A 24VAC / SCREWS
PNL14732	5	1	PANEL; CONTROL PANEL BASE, 27.14 HEIGHT

Part No.	Reference No.	Quantity	Description
0000030327~P	*		AIR SYSTEM

FAN

75010673

REV
A

TYPICAL ILLUSTRATION

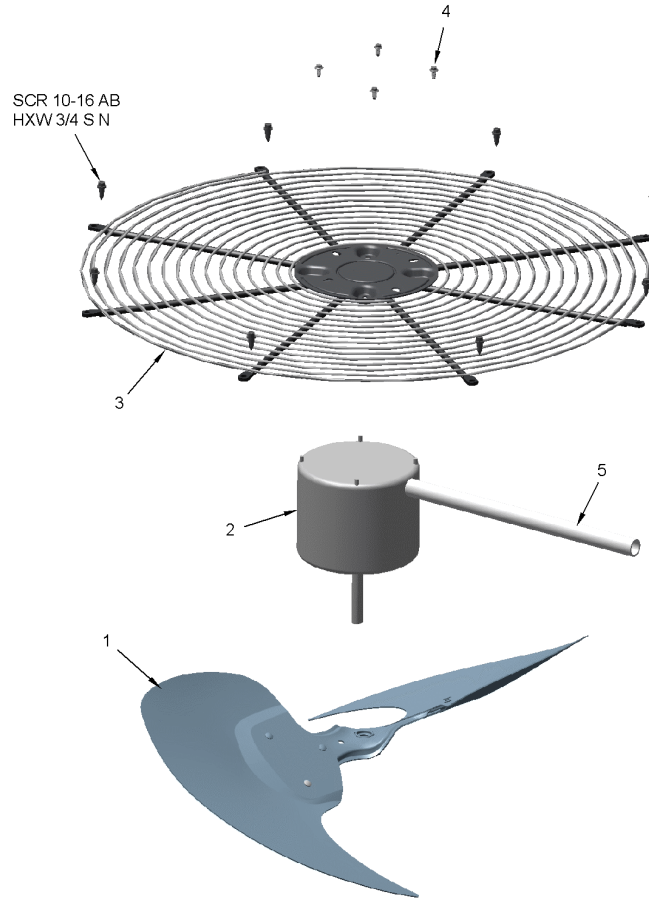

Part No.	Reference No.	Quantity	Description
FAN06513	1	1	FAN; TR2R30-2
MOT20226	2	1	MOTOR; 1/8 HP 48 FRAME PSC
GRL01366	3	1	GRILLE; FAN
SCR02086	4	4	SCREW; 10-32 TR-3 HXW 3/8 S
GRD01440	5	1	GUARD; TROUGH-LEAD

Part No.	Reference No.	Quantity	Description
000004361~P	*		GENERAL ASSEMBLY GRAPHIC

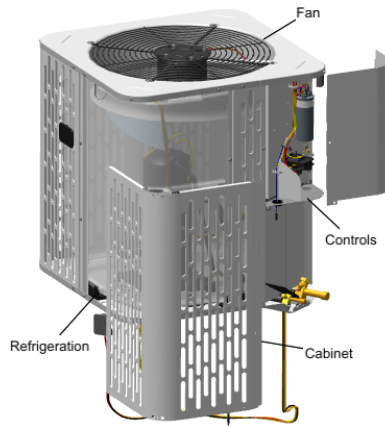

Part No.	Reference No.	Quantity	Description
0000030275~P	*		REFRIGERANT SYSTEM

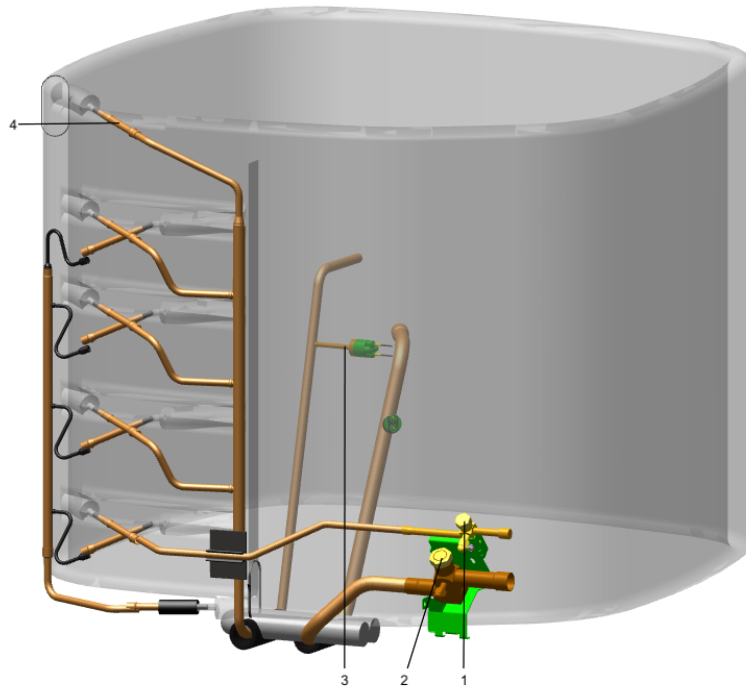

Part No.	Reference No.	Quantity	Description
BRK03696	*	1	BRACKET; VALVE
COL25245	*	1	COIL; OUTDOOR, SPINE FIN
SCR02010	*	4	SCREW; 12-18 AB HXW 1/2 SN
SCR02054	*	4	SCREW; 12-18 AB HXW 1/2 SN
TUB02810	*	8	TUBE; TRANSITION
VAL09293	*	1	VALVE, SERVICE LIQUID, .38 OD X .38 OD, VALVE ASSY
COM11996		1	COMPRESSOR; SCROLL; LG; LBA020C1CLA; 1.75 TON; 19,500 BTUH; 208/230-60-1; R-410A; BRAZED; SUCTION 3/4; DISCHARGE 1/2
CAP01336	1	1	CAP; SERVICE LIQUID VALVE, BRASS, 0.75 OD X 0.57 ID X 11/16-28UN-2B
CAP01315	2	1	CAP; SERVICE LIQUID VALVE, BRASS, 1.06 OD X 0.81 ID X 15/16-20UNEF-2B
SWT03274	3	1	SWITCH, HIGH PRESSURE, SPST, OPEN @ 650 PSIG, CLOSE @ 500 PSIG, 75' YELLOW LEAD
TUB11547	4	8	TUBE; TRANSITION ASSEMBLY