

## MSC-1 Control Panel for Snow & Ice Melting Installations Installation & Operation Instructions

### General

The MSC-1 Control Panel manages snow and ice melting equipment for sidewalks, driveways, gutters, etc... Suitable for controlling heating cables and mats and self-regulating cables, the MSC-1 can monitor snow and ice accumulation in three separate zones. The MSC-1 programming allows each zone to be controlled independently or on a priority mode basis. In the "priority" mode for example, one zone can be given priority and the other zones cannot be energized until the melting/de-icing in that zone is complete. This can then reduce the loading on the circuit by ensuring that multiple zones are not energized simultaneously. The MSC-1's program allows customization of the key elements necessary for intelligent and efficient snow melting control.

The MSC-1 uses information from up to three different types of moisture sensors—surface (or in-ground, MSP-1), aerial (MSA-1) and gutter (MSG-1)—and one type of temperature sensor (TS-1). The surface, aerial and gutter sensors detect moisture—snow, ice, sleet, etc.—and send appropriate signals to the MSC-1. Similarly, the temperature sensor sends temperature data back to the MSC-1. Independent temperature and moisture information is processed by the MSC-1 to ensure that heating equipment will only be energized when precipitation occurs during freezing conditions. For each of the MSC-1 control zones up to two individual moisture sensors can be connected.

Each MSC-1 must have a temperature sensor, TS-1, in order to function; a TS-1 is included with each MSC-1.

The MSC-1 is housed in an enclosure (NEMA 4, 4X) suitable for commercial/industrial indoor applications and features an LCD display, programming and associated indicator lights for operation of each zone.

The MSC-1 is powered by 120VAC; control signal relays provide a 120VAC output to operate the coils of external contactors. See Fig. 1 & 2.

### Sensor Wiring Note

Each of the MSC-1 sensors communicates with the MSC-1 Control Panel. The sensor wires must not be run in conduit with power wires or telephone lines, their magnetic field will cause communication problems; see sensor installation instructions for full details.

### Pre-Programmed Configuration (Default)

The MSC-1 Control Panel is delivered preprogrammed for a one zone system, for use with either an aerial (MSA-1) or gutter (MSG-1) sensors. The ambient off temperature (the MSC-1 will not energize the heating equipment when the ambient temperature is warmer than this value) is pre-set to 37°F (3°C), and relay hold time (the length of time that the heating equipment will stay energized after no longer senses the presence of ice/snow in the zone) is 3.0 hours. If the snow/ice melting system has been designed to operate in this manner, then no programming is required: simply wire as per the following instructions.

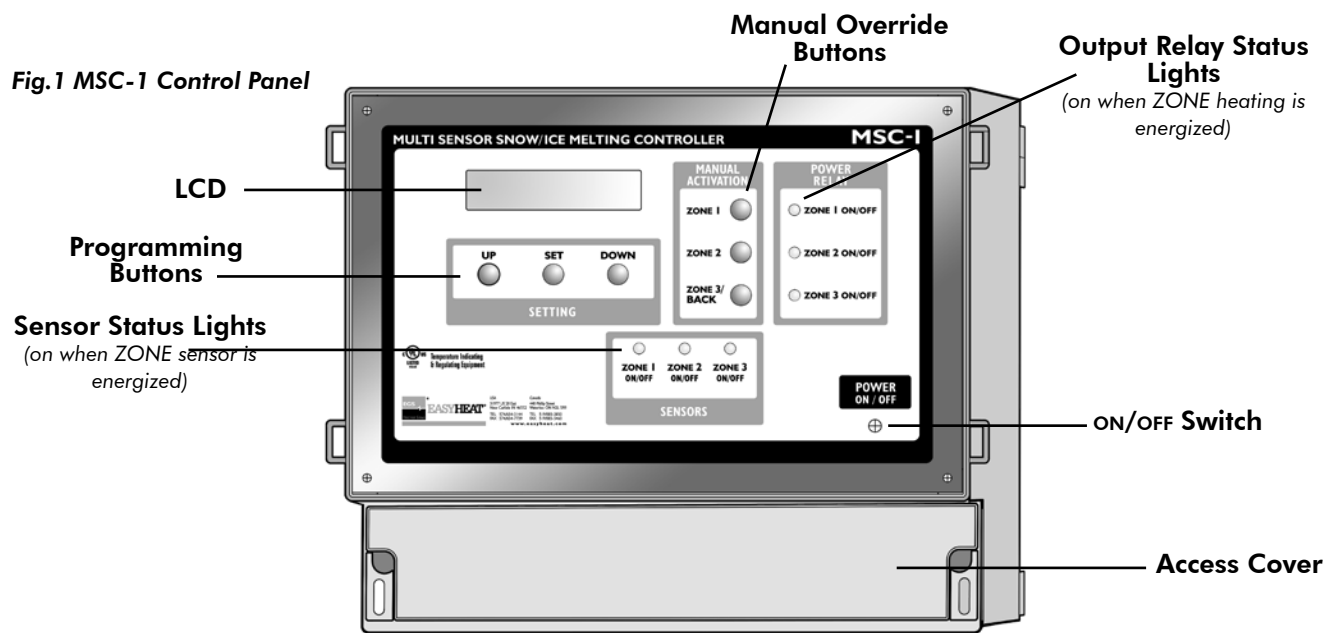
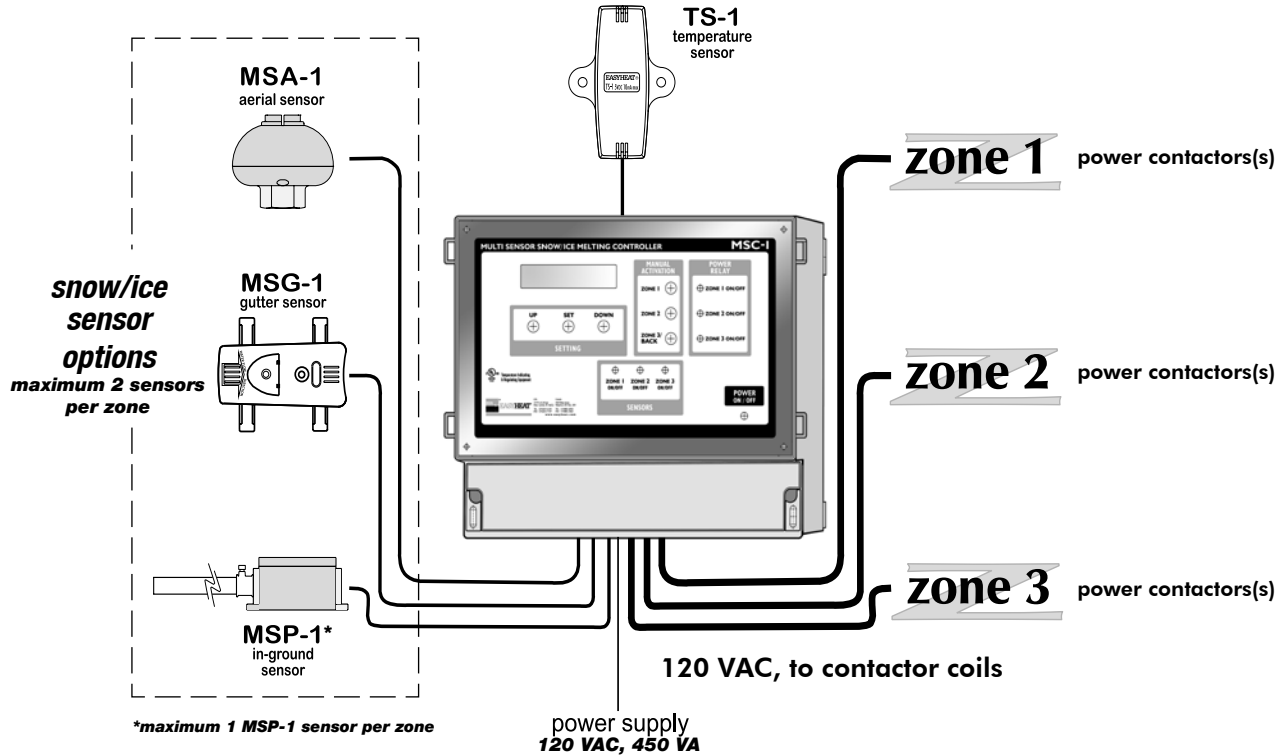

Fig.1 MSC-1 Control Panel

## 2 MSC-1 Installation & Operating Instructions

Fig.2 Sample Application Illustration



### WARNINGS

1. This is not a "do-it-yourself" product. A qualified electrician must install the MSC-1.
2. Completely read these instructions prior to any and all installations.
3. If after carefully reading these instructions you still have questions regarding installation, operation or maintenance of this product, call the numbers listed for assistance.
4. Prior to installation, check the MSC-1 Control Panel for possible shipping damage. Do not install a damaged MSC-1 Control Panel.
5. All heating equipment, controls & associated systems must be installed in compliance with the latest editions of all applicable electrical codes and ordinances.
6. The MSC-1 has been designed to accept only EasyHeat moisture and temperature sensor inputs. The risk of fire or electric shock exists if the MSC-1 is connected to any device other than an EasyHeat sensor.
7. Do not connect heating equipment directly to the MSC-1 Control Panel. The MSC-1 control signal relays provide an output to operate external contactors each output provides a maximum current output of 1.25A. The risk of fire or electric shock exists if the heating equipment is directly connected to the MSC-1 Control Panel.
8. These instructions must be saved and made available to owners or users of this product and/or transferred to future owners.
9. Secure the MSC-1 in an indoor location. The MSC-1 Control Panel is not suitable for installations environments subject to condensing moisture or those exposed to temperature extremes.
10. Avoid shock or vibration.

### INSTALLATION INSTRUCTIONS

The MSC-1 is shipped pre-programmed for operation with either one MSA-1 or one MSG-1 sensor and with zone 1 output active. If this is your type of installation, skip to the pre-programmed connection section.

1. Mount the MSC-1 securely to the wall with three #10 screws, mount in an upright position in an indoor location, in an area that is dry and not subject to temperature extremes. See Fig.3 for mounting details.
2. Four 1/2" connectors have been installed on the MSC-1 Control Panel box to facilitate connection of electrical conduit for input power supply wiring, and contactor output wiring.
3. Remove the lower front access cover to begin connecting wiring. On the back of the access cover is a label that must be used as a wiring guide.
4. Connection to the MSC-1 is done through terminal blocks. Fish the wire being connected through the adjacent knock-out, and pull out approximately 12" of wire. The top half of the terminal block is removable for easy wiring, gently pull up on the top half to remove. After connecting to the wire to the top half gently set it back into the base, while carefully pulling back excess wire through

Fig.3 Mounting: mounts to wall via three #10 screws

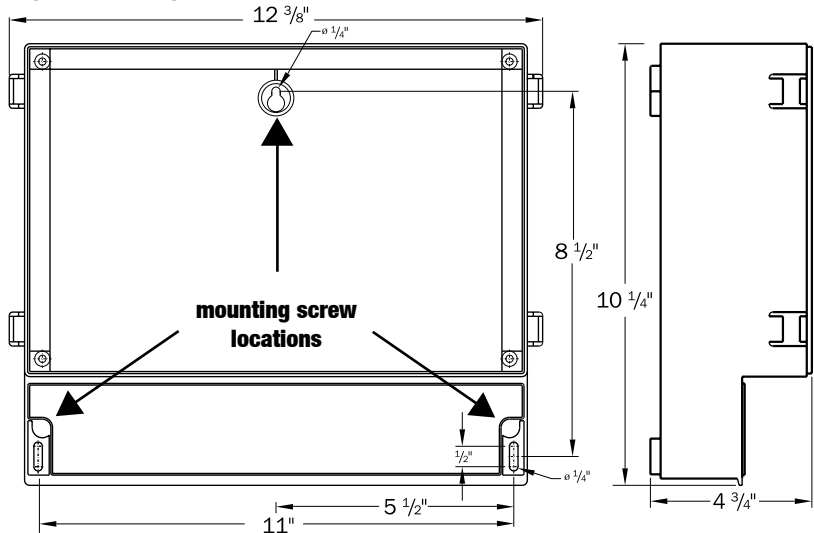

## INSTALLATION INSTRUCTIONS (continued)

the knockout.

5. The MSC-1 terminal blocks serve 5 distinct connection sectors (see Fig 4), they are:
  - 1) TS-1 - temperature sensor,
  - 2) MSA-1 aerial sensors / MSG-1 gutter sensors (one each per zone),
  - 3) MSP-1 in-ground sensors (one each per zone),
  - 4) Output to power contactors (one each per zone),
  - 5) Power input.

Connection to each sector is described below.

6. The TS-1 is connected to the left-most terminal block, identified as TEMP. SENSOR. The MSC-1 will not function if the TS-1 wire colour codes are not properly matched at the terminal block. See Fig.4
7. The MSA-1 or the MSG-1 may be connected to any one of the 3 terminal blocks, identified as A/G. SENS. The Zone number at the terminal block correlates to a snow-melting zone, ensure that the sensor is connected to the proper zone terminal. The MSC-1 will not function properly if the MSA-1/MSG-1 wire colour codes are not properly matched at the terminal block. See Fig.4
8. The MSP-1 may be connected to any one of the 3 terminal blocks identified as PAV. SENS. The Zone number at the terminal block correlates to a snow-melting zone, ensure that the sensor is connected to the proper zone terminal. The MSC-1 will not function properly if the MSP-1 wire colour codes are not properly matched at the terminal block. See Fig.4
9. The outputs to the power contactors may be connected to any one of the 3 terminal blocks in the -OUTPUT TO POWER CONTACTORS- segment, ZONE#1, 2 or 3.  
The Zone number at the terminal block correlates to a snow-melting zone, ensure that the output being connected matches the sensor inputs connected. The output wire must be connected with the polarity as noted, ensure voltage and amperages are suitable for the contactor being used. The MSC-1 will not function properly if the output connections are improperly made. See Fig.4
10. The power supply is connected to the right-most terminal block, identified as POWER SUPPLY. The power supply wires must be connected with the polarity as noted, ensure supply voltage is correct and noted ampacity is available. The MSC-1 will not function if the power supply connections are improperly made. See Fig.4
11. At this point a quick check on the power supply wiring can be made. Energize the supply circuit for the MSC-1 Control Panel, and turn on the MSC-1 via the toggle switch, the LCD should illuminate at this point. Reattach the front access cover, connection of the MSC-1 is complete.
12. Each of the MSA-1, MSG-1 or MSP-1 sensors connected to the MSC-1 must be activated by programming the MSC-1; to do so, follow

## PRE-PROGRAMMED (DEFAULT) CONNECTIONS

1. With the front access panel removed and wiring routed to the MSC-1.
2. Connect the temperature sensor lead to the temperature sensor terminal block.
3. Connect the aerial or gutter sensor lead to the Zone 1 sensor terminal block.
4. Connect the control wire from the contactor coil to the Zone 1 output terminal block, 120VAC only. **DO NOT CONNECT OUTPUT DIRECT TO THE LOAD, THIS WILL DESTROY THE MSC-1, RESULT IN RISK OF INJURY OR FIRE.**
5. Connect 120VAC to the power supply terminal block, watch polarity.
6. Turn on the power to the MSC-1 using the toggle switch on the front panel.
7. System is now operational.

Fig.4 MSC-1 Control Panel (access cover removed)

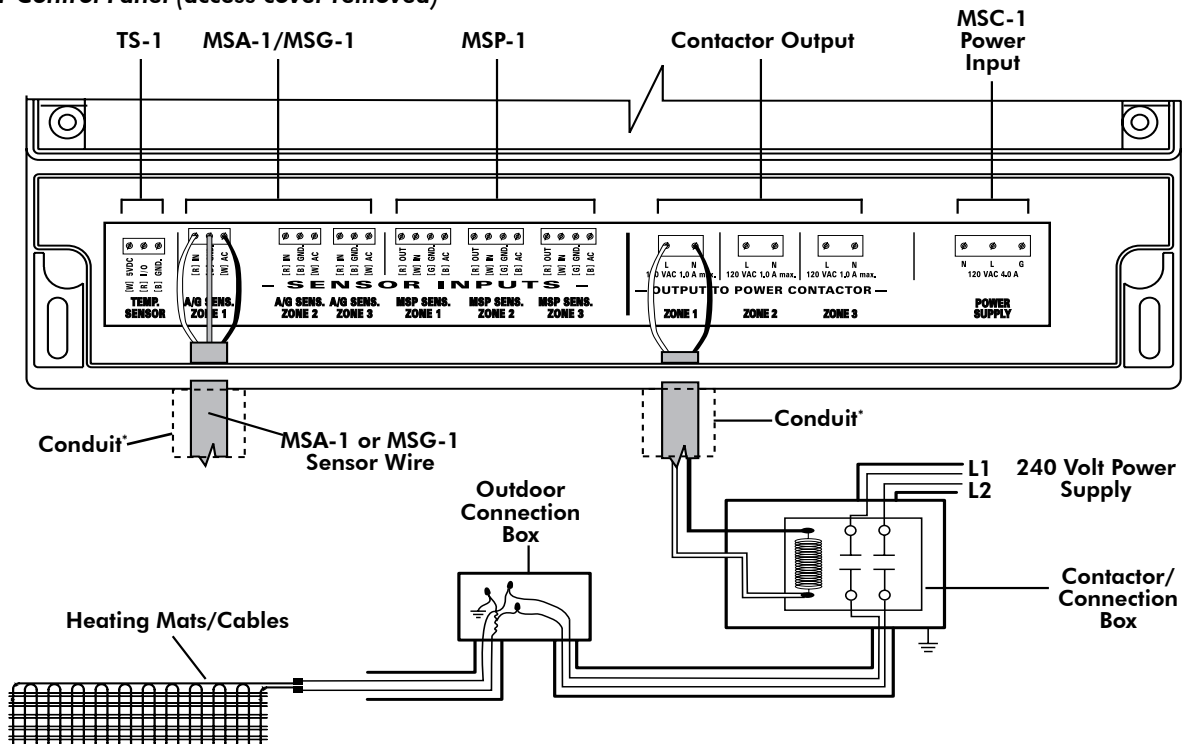

\*As required by electrical codes

Fig.4 MSC-1 Control Panel (access cover removed)

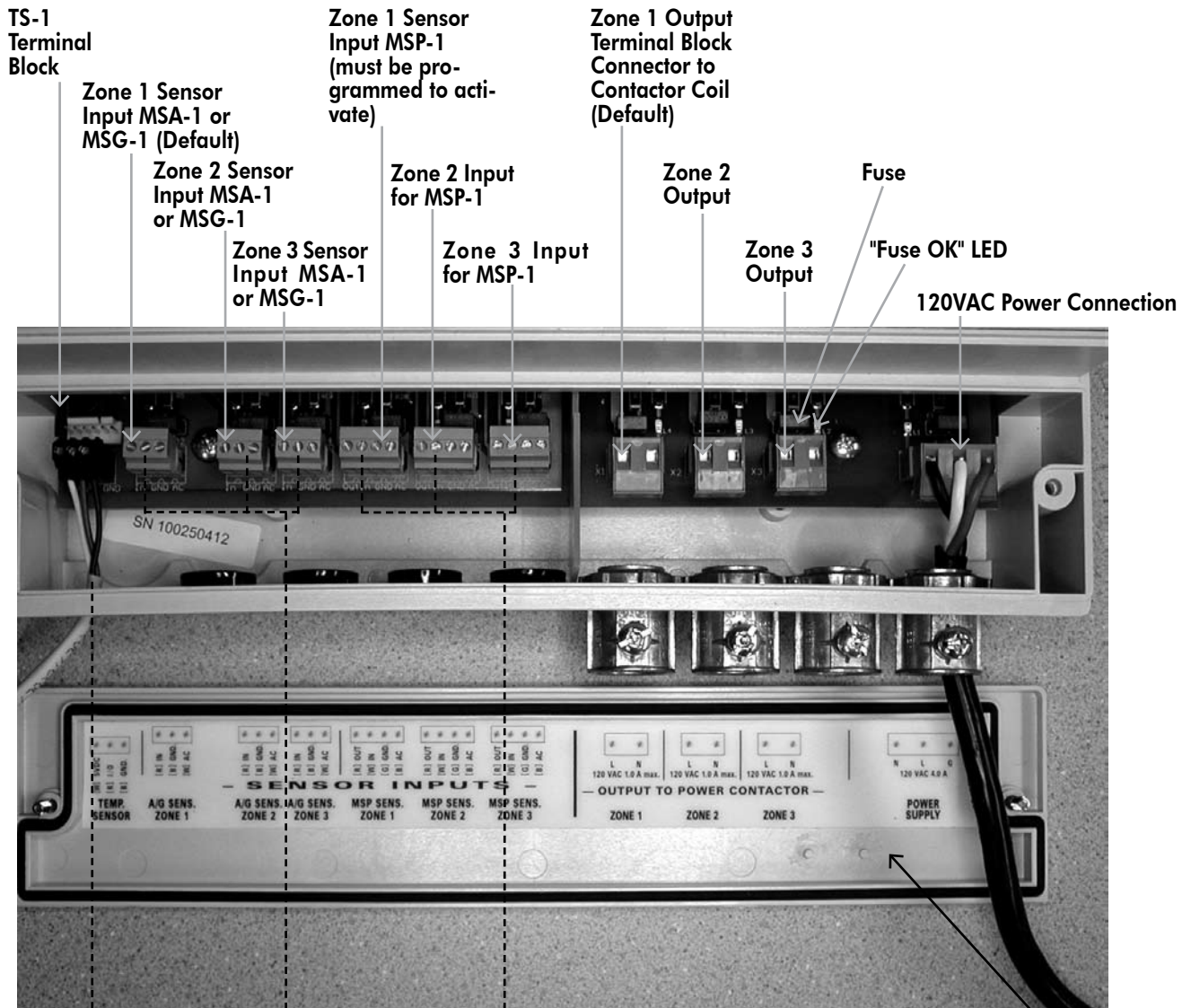

**Temperature Sensor, TS-1:** this is included with the MSC-1 and must be installed outdoors to sense air temperature.



**Aerial Snow Sensor, MSA-1:** mast mounted to sense falling snow (may be used as the preprogrammed sensor).

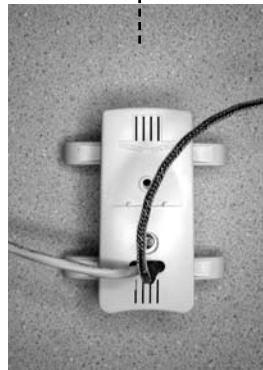

**Gutter Sensor, MSG-1:** secured in the gutter to detect moisture conditions (may be used as the preprogrammed sensor).

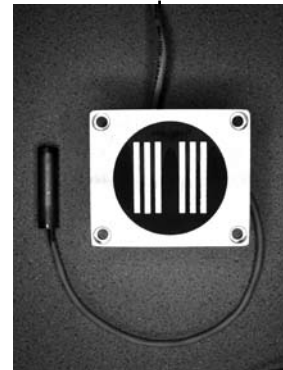

**In-ground Sensor, MSP-1:** installed in-ground to detect moisture and slab temperature (the MSC-1 must be programmed to recognize this sensor, refer to the instruction manual for details).

## SYSTEM CHECK

---

### Before you power up, confirm:

- All the sensors, relay coils and the power supply are connected to the proper terminal blocks.
- Only unshielded (shielded for MSP-1) cable was used to extend the sensors, with a maximum size of 18AWG.
- The polarity of the power supply is appropriate, 120VAC.
- You have connected the output terminals to a relay or contactor coil, NOT DIRECTLY TO THE LOAD

### After powering up, you should see:

- The display lit and reading the temperature in the area of the TS-1.
- The small green LED's next to the connected terminal blocks are lit (no LED for the TS-1 block).
- The sensor lights (for the activated zone sensors) on the front panel will be lit.

### To cycle system and check sensor operation:

1. Submerge the TS-1 in a litre of water and crushed ice.
2. After 20 minutes, confirm the display reads 32F (0C).
3. Put a drop of water on each sensor surface\*, the Power Relay lights on the front panel will light up and the associated relay output will energize.
4. Dry off the sensor surface. The relay output will de-energize and the relay light will turn off after the pre-set hold time (e.g. 3.0 hrs).

\* To confirm MSP-1 operation, the slab temperature must be below 59°F (15°C).

## OPERATION

---

The MSC-1 is a programmable controller, capable of controlling three separate snow/ ice melting zones. A control relay for each zone is included in the MSC-1 to operate a contactor for each zone to energize the snow/ice melting equipment. There are two operating mode selections possible with the MSC-1:

### Mode 1 – Independent

In this mode each snow/ice melting zone is controlled independently. Mode 1 allows all 3 zones to be energized simultaneously. This mode is best used where circuit loading is not a concern (e.g. adequate circuit ampacity is available to operate the entire snow/ice melting load simultaneously).

### Mode 2 – Priority

In this mode each zone is controlled on a priority basis, with the most critical zone (always Zone 1) being melted first, followed then by the less critical zones. Mode 2 allows only 1 of the zones to be energized at a time. This mode is best used where circuit loading is a concern. A slight delay is provided when switching power between zones to ensure circuits are not overloaded. Set-up in Mode 2 must be done either with Zones 1 & 2, (with Zone 3 not being used), or Zones 1, 2 & 3. Operation is sequential, beginning with Zone 1. When Zone 1 is melted, the MSC-1 de-energizes it and then energizes Zone 2. However if snow/ice is detected on Zone 1, Zone 2 is de-energized and Zone 1 re-energized. Similar logic applies for Zone 2 & 3; i.e. the lower numbered zone always takes priority.

The Priority mode available in the MSC-1 can reduce circuit loading by splitting up a large snow melting area into separate, smaller zones. For example, if a large area would require 90 Amps of current, this could be split into two separate zones of, say, 50 Amps in one zone and 40 Amps in the other. Then, by programming the MSC-1 in the Priority Mode, only one zone will be enabled at any one time, resulting in a maximum circuit loading of 50 Amps. Similarly, the area could be split into three zones of, say 25, 35 and 30 Amps; in this case circuit loading would be 35 Amps maximum. It should be further noted that when in Priority mode, the MSC-1 always gives priority to Zone 1; when Zone 1 is completely melted, then Zone 2 is enabled until melted, and then, finally Zone 3; i.e. Zone 1 always has higher priority over Zone 2, which has higher priority over Zone 3. Further, if snow/ice is detected in a zone with higher priority, then operation reverts to the zone with higher priority. For example, if melting has been completed in Zone 1, and Zone 2 has thus been enabled, then if snow/ice is detected in Zone 1, operation in Zone 2 will be suspended, and Zone 1 will be re-enabled until melting is again complete, at which time melting in Zone 2 will recommence.

It is also important to give consideration to the assignment of zones; usually, high traffic areas will be given priority, with lower traffic areas given lower priority. Zones can be easily reassigned at the wiring terminals of the MSC-1.

## Zone Assignment

---

The MSC-1 uses the concept of a zone system to most efficiently control snow/ice melting equipment. The term "zone" means an area (either surface area or roof/gutter area, or some combination of both) heated by a specific set of snow/ice melting equipment that is controlled in a common manner. The MSC-1 allows for up to three zones, and each zone can have multiple moisture sensors for, say, roof/gutter, aerial and/or surface snow/ice detection. If any one of the sensors detects moisture, the heating equipment may be energized. The moisture sensor in the zone should be, generally, "surrounded" by the heating equipment to ensure that the heating equipment is only energized when there is indeed snow/ice present in the zone.

Zones can be used to represent different areas; for example a parking ramp area could be one zone while roof/gutter de-icing on the same building could be another zone. Similarly, two sidewalks on different sides of the same building (possibly one on the north side and one on the south side) could represent two separate zones. The perimeter of a football stadium could be split into three separate zones to reflect different weather conditions on different sides of the building.

## 6 MSC-1 Installation & Operating Instructions

### Manual Operation

The power to any one of the snow-melting zones may be activated manually by pressing and holding the ZONE X button until the information below appears on the LCD screen. Manual activation will only work as long as the ambient temperature is below the MSC-1 shut-off temperature. The duration of the time the zone will remain energized (Time Delay) is pre-set to 2.0 hours; this can be adjusted by following the programming instructions below.

The minimum and maximum settings possible are noted on the LCD, adjustable in 0.5 hour increments.

```
M. Time Delay Zone 1
min.0 <2.0H> Max.10
```

Pressing UP increases the delay time.  
Pressing DOWN decreases the delay time.  
Press the SET button to accept the chosen delay time.

Once the delay time is set, the MSC-1 returns to normal control function, and energizes the heating equipment for the selected zone.

To de-energize the manually activated heating equipment, turn off using the toggle switch on the front panel.

When operating in Mode 2 – Priority, the manual override works as described if no snow melting zones are energized. If any snow-melting zone is energized the manual override only works to energize the higher priority zone, thereby de-energizing the lower priority zone.

It is important to note that manual operation is not possible if the MSC-1 has already energized the zone, and that manual control will be overridden if the zone moisture sensor detects precipitation.

### LCD Explanation

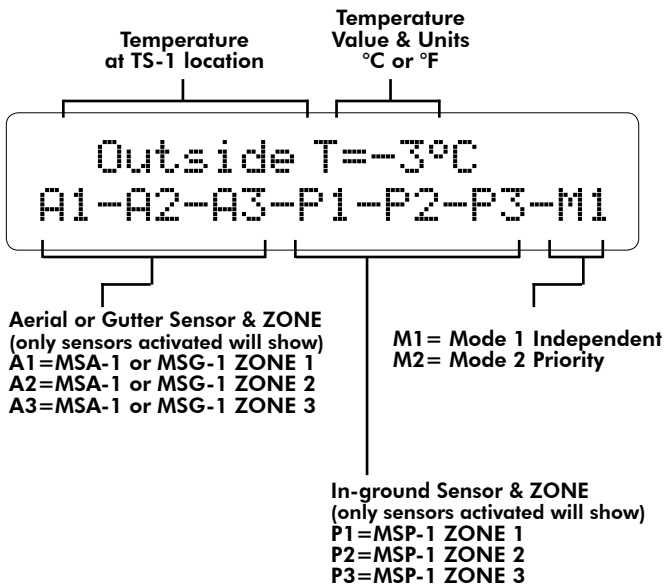

### Programming Instructions

The MSC-1 program has been structured into 6 levels; within each of these levels are further degrees of selection. Each programming step is clearly described on the LCD, and easily adjusted by the "UP", "DOWN", and "SET" buttons.

#### During programming:

- All regular operating functions of the MSC-1 are suspended.
- If a button is not pressed for approximately 90 seconds, the program will return to normal operation, saving programming changes made up to the point exited.
- Pressing the BACK button results in an exit from the programming sequence, with the changes made up to that point saved.

#### Resetting to Factory Conditions

When the MSC-1 is first energized, and during the time the initial LCD display (MSC Ver. X.X) screen shows push the UP and DOWN buttons simultaneously to access the option to revert to factory set conditions. Use the UP or DOWN button to select "yes" or "no"; the program accepts the selection and returns to normal operation.

To begin programming the MSC-1 hold the SET button down for 5 seconds. The display will start in program level 1. To move to other levels use the UP or DOWN buttons.

#### Level 1. Temperature Unit Selection

```
PROGRAM MODE
1. Degree: °C or °F
```

The default temperature units setting is °F.

To move to the next level use the UP or DOWN buttons. Press the SET button to select the temperature display units.

```
1. Degree: °C or °F
<°C >                <°F >
```

Pressing UP selects Degrees C.

Pressing DOWN selects Degrees F.

After pressing the UP or DOWN button, the program automatically accepts the selection and advances to the next program level.

#### Level 2. Operating Mode Selection

```
PROGRAM MODE
2.Mode: 1 or 2
```

The default mode setting is Mode 1.

To move to the next level use the UP or DOWN buttons. Press the SET button to select the operating mode.

```
2.Mode: 1 or 2
<No.1 >        <No.2 >
```

Pressing UP selects Mode 1 (Independent).

Pressing DOWN selects Mode 2 (Priority).

After pressing the UP button for Mode 1, the program automatically accepts the selection and advances to the next program level.

After pressing the DOWN button for Mode 2, the program automatically accepts the selection and then moves to another input screen, as shown below.

After pressing the UP or DOWN button for <PZone3>, the program automatically accepts the selections and advances to the next program level.

**Level 4. Ambient Off Temperature Setting**

2. Mode No.2  
<2zones> <3zones>

Pressing UP selects a 2 Zone system (Zone 1 & 2).  
Pressing DOWN selects a 3 Zone system (Zone 1, 2 & 3).  
After pressing the UP or DOWN button, the program automatically accepts the selection and advances to the next program level.

**Level 3. Sensor Activation/De-activation**

PROGRAM MODE  
3.Sensor Activation

The default sensor activation setting is for an aerial (MSA-1), or gutter (MSG-1) sensor, zone1.  
To move to the next level use the UP or DOWN buttons.  
Press the SET button to begin the process to activate or deactivate sensors. Each of the 3 control zones may have up to 2 individual sensors, for a total of 6 sensors. <A/G.ZoneX> refers to either an MSA-1 or MSG-1 sensor, <P.ZoneX>, refers to an MSP-1 in-ground sensor. The activation/deactivation operation for all 6 sensors must be stepped through before this operation is complete.

3.Sensor Activation  
Yes <A/G.Zone1> No

3.Sensor Activation  
Yes <A/G.Zone2> No

3.Sensor Activation  
Yes <A/G.Zone3> No

Yes <P.Zone1> No  
3.Sensor Activation

Yes <P.Zone2> No  
3.Sensor Activation

Yes <P.Zone3> No  
3.Sensor Activation

Pressing UP activates the selected sensor.  
Pressing DOWN de-activates the selected sensor.

PROGRAM MODE  
4.Ambient Off Temp.

The default ambient off temperature is 37°F (3°C).

To move to the next level use the UP or DOWN buttons.  
Press the SET button to adjust the ambient off temperature, the temperature above which the MSC-1 will no longer energize the heating equipment. The minimum and maximum settings possible are noted on the LCD.

4.Ambient Off Temp.  
min.34 <37°F> Max.50

Pressing UP increases the degree setting.  
Pressing DOWN decreases the degree setting.  
Press the SET button to accept the chosen ambient off temperature and advances to the next program level.

**Level 5. Slab Off Temperature Setting (MSP-1 Sensors)**

PROGRAM MODE  
5.Slab Off Temp.

The default slab off temperature is 50°F (10°C).  
To move to the next level use the UP or DOWN buttons.  
Press the SET button to adjust the slab off temperature, the temperature above which the MSC-1 will de-energize the in-ground heating equipment. The minimum and maximum settings possible are noted on the LCD.

5.Slab Off Temp.  
min.41 <50°F> Max.68

Pressing UP increases the degree setting.  
Pressing DOWN decreases the degree setting.  
Press the SET button to accept the chosen slab off temperature and advances to the next program level.

**Level 6. Setting the Relay Hold Time**

PROGRAM MODE  
6.Relay Hold Time

The default relay hold time is 3.0 hours for all zones.  
To move to the next level use the UP or DOWN buttons.  
Press the SET button to adjust the relay hold time for the snow melting zones. The relay hold time is the amount of time the snow melting zone remains energized after the moisture sensor is dry. Each of the 3 zones is set independently, in

## 8 MSC-1 Installation & Operating Instructions

0.5 hour increments. The minimum and maximum settings possible are noted on the LCD. The relay hold times for all 3 sensors must be stepped through before this operation is complete.

```
6.Relay Hold Time Z1
min.0 <3.0H> Max.10
```

```
6.Relay Hold Time Z2
min.0 <3.0H> Max.10
```

```
6.Relay Hold Time Z3
min.0 <3.0H> Max.10
```

Pressing UP increases the relay hold time.  
Pressing DOWN decreases the relay hold time.  
Press the SET button to accept the chosen relay hold time and advance to the timing for the next zone.

After the hold time for Zone 3 has been set the program automatically returns to programming Level #1 "Temperature Unit Selection". To exit the programming sequence and return to normal control operation press the BACK button.

### **Temperature Stand-by**

Whenever the ambient air temperature exceeds the ambient off temp, the MSC-1 goes into a "temperature stand-by" mode, at which time all moisture sensors are de-activated. As soon as the ambient air temperature drops below the ambient off temp, the sensors are reactivated and operation begins as normal.

```
Outside T = 10°F
Temperature Stand-by
```

Pressing UP increases the relay hold time.  
Pressing DOWN decreases the relay hold time.  
Press the SET button to accept the chosen relay hold time and advance to the timing for the next zone.

After the hold time for Zone 3 has been set the program automatically returns to programming Level #1 "Temperature Unit Selection". To exit the programming sequence and return to normal control operation press the BACK button.

### **Temperature Stand-by**

Whenever the ambient air temperature exceeds the ambient off temp, the MSC-1 goes into a "temperature stand-by" mode, at which time all moisture sensors are de-activated. As soon as the ambient air temperature drops below the ambient off temp, the sensors are reactivated and operation begins as normal.

## Error Messages

The MSC-1 will display an error message whenever a problem is detected with the connection to the TS-1 or any of the MSP-1's. Note that the connection status to a gutter (MSG-1) or aerial (MSA-1) sensor is not monitored by the MSC-1.

### TS-1 Error

```
Manual only      <M1>
Error!- TS-1 <cancel>
```

### MSP-1 Error

```
Error!- P-1
                        <cancel>
```

The error screen will flash intermittently with the standard operating screen. To cancel the error message press the DOWN button when the error screen is showing.

If there is a TS-1 error all automatic operation of the MSC-1 ceases, however manual operation of each zone is still possible.

If there is an MSP-1 error, automatic control of the associated zone is suspended, again manual operation is still possible. Once the sensor problem has been fixed turn off the power to the MSC-1 Control Panel at the toggle switch, reconnect the sensor wiring to the terminal block, then after a minimum 10 seconds turn back on the power. The MSC-1 program will recognize the sensor and begin normal operation.

## TROUBLESHOOTING GUIDE

Problem	Possible Cause	Correction
System is not operating and system is not lit.	No power to MSC-1.	Turn on power using switch on front panel.
Display is not lit and power switch is on.	Supply not energized or power input fuse burned out.	Check power supply. If LED above power input terminal connection is not lit, replace fuse (4A spare fuse supplied with MSC-1).
System is not operating, Temperature Standby on display.	The MSC-1 is in a standby mode, the ambient temperature outside is above the temperature required to melt snow and so the system goes into a standby mode.	<b>NORMAL OPERATION</b> , however, if required, the Ambient Off Temperature can be adjusted, see the MSC-1 programming instructions for complete detail.
Error! - TS-1 on display and system not operating.	There is a communication problem with the temperature sensor.	Make sure the temperature sensor lead wires are connected to the terminal properly. If the sensor wire has been extended, use no smaller gauge than 3 wire 18ga UN-SHIELDED cable. Make sure the sensor wire is run in a dedicated conduit. The system can be run manually. See the MSC-1 programming instructions for complete detail.
Error! - TS-1 on display after corrections made.	Need to clear TS-1 error from MSC-1 program.	Turn off system using the front panel switch, wait 10 seconds and turn on again. The MSC will now recognize the sensor.
Error! - P-1 on display and system not operating.	There is a communication problem with the in-ground sensor.	Make sure the in-ground sensor lead wires are connected to the terminal properly. If the sensor wire has been extended use no larger than 4 wire 18ga SHIELDED cable. The system can be run manually. See the MSC-1 programming instructions for complete detail.
The aerial or gutter sensors are wet (covered in snow), the LED above the corresponding terminal block is lit and the system is not turning on heating.	Possible communication problem with the aerial or gutter sensor. No error message will show on the display when this occurs.	Make sure the aerial or gutter sensor lead wires are connected to the terminal properly. If the sensor wire has been extended use no larger than 3 wire 18ga SHIELDED cable. The system can be run manually. See the MSC-1 programming instructions for complete detail.
The in-ground sensor is wet (covered in snow), the sensor surface is warm and system is not turning on heating.	The surface of the in-ground sensor may be dirty, possibly covered with sealant.	Clean the sensor surface to get rid of any contaminant, use mild detergent and carefully scrub with steel wool.

## Specifications

### Electrical

**Power Requirements**  
120 VAC, 50/60hz, 480 VA

**Control Relays - Outputs**  
120VAC, Pilot Duty, 120VA

**Power Supply – Sensors**  
24VAC, Class 3, 12VA

**Temperature Sensor Supply**  
5VDC, Class 2, 0.5VA

### Mechanical

Plastic enclosure

### System Memory

Nonvolatile: no data loss  
with a loss of system power

### Dimensions

11" wide (cabinet; 12.375" overall width)  
X 10.25" high  
X 4.75" deep

### Certification

UL Listed to US and Canadian safety  
standards

### Environmental Specifications

**Ambient Operating Temperature Range**

-4°F to 50°F / -20°C to 70°C

**Relative Humidity**

0 to 90% RH, non condensing

**Storage Temperature**

-4°F to 185°F / -20°C to 85°C

*Temperature extremes may adversely  
affect components such as the Liquid  
Crystal Display (LCD).*

## LIMITED WARRANTY AND LIABILITY

Easy Heat warrants that if there are any defects in material or workmanship in any heating cable or accessory during the first year after the date of purchase. We will provide new products to replace any defective items, or we will refund the purchase price paid for the accessory or cable, not including any labor or other installation costs. As an alternate, we may elect to repair the cable or accessory at our factory with all shipping and other removal costs borne by the purchaser.

We further warrant that for a period of twelve (12) months after the date of performance any services performed hereunder will be in a good and skillful manner, based on our understanding of pertinent technical data as of the date of performance of such services. Easy Heat's sole responsibility and liability in the event of any defect, error, omission, or failure in the services rendered hereunder shall be to provide corrected services of the type provided for herein, designed to correct such defect, error, omissions, or failure, and in no event shall Easy Heat's liability with respect to such warranty exceed the amount received by it from the Buyer on account of such services.

Our obligation to provide corrected services, new products, refund the purchase price, or perform the repair described above is conditioned upon (a) the installation of the accessory or cable conforming to the specifications set forth in our installation instructions and (b) the accessory or cable not having been damaged by mechanical or electrical activities unrelated to the operation of the accessory or cable.

A refund of your purchase price, provision of replacement products, repair of the accessory or cable or provision of corrected services as described above, shall be your sole and exclusive remedy for a breach of this warranty. **THESE ARE THE SOLE AND EXCLUSIVE WARRANTIES GIVEN BY EASY HEAT WITH RESPECT TO THE GOODS AND SERVICES AND ARE IN LIEU OF AND EXCLUDE ALL OTHER WARRANTIES, EXPRESS OR IMPLIED, ARISING BY OPERATION OF LAW OR OTHERWISE, INCLUDING WITHOUT LIMITATION, MERCHANTABILITY AND FITNESS FOR A PARTICULAR PURPOSE WHETHER OR NOT THE PURPOSE OR USE HAS BEEN DISCLOSED TO EASY HEAT IN SPECIFICATIONS, DRAWINGS OR OTHERWISE, AND WHETHER OR NOT EASY HEAT'S PRODUCTS ARE SPECIFICALLY DESIGNED AND/OR MANUFACTURED BY EASY HEAT FOR YOUR USE OR PURPOSE.**

This warranty does not extend to any losses or damages due to misuse, accident, abuse, neglect, normal wear and tear, negligence, unauthorized modification or alteration, use beyond rate capacity, or improper installation, maintenance or application. To the extent that you or your agents have supplied specifications, information, representation of operating conditions or other data to Easy Heat in the selection or design of the Goods and the preparation of Easy Heat's quotation, and in the event that actual operating conditions or other conditions differ from those represented by you, any

warranties or other provisions contained herein which are affected by such conditions shall be null and void.

If within thirty (30) days after your discovery of any warranty defects within the warranty period, you notify Easy Heat thereof in writing, Easy Heat shall, at its option, repair, correct or replace F.O.B. point of manufacture, or refund the purchase price for, that portion of the Goods found by Easy Heat to be defective. Failure by you to give such written notice within the applicable time period shall be deemed an absolute and unconditional waiver of your claim for such defects. Goods repaired or replaced during the warranty period shall be covered by the foregoing warranty for the remainder of the original warranty period or ninety (90) days from the date of shipment of the repaired or replaced goods, whichever is longer.

**This limited warranty does not cover any costs relating to the repair or replacement of any accessory or cable at the installation site. Our accessories and cables are not easily accessible. A failed accessory or cable usually cannot be easily repaired. Replacement of a failed accessory or cable will require that the materials under which it is installed be removed to permit replacement of the accessory or cable. We will not reimburse any costs relating to the repair or replacement of any accessory or cable at the installation site.**

**IN NO EVENT, REGARDLESS OF THE FORM OF THE CLAIM OR CAUSE OF ACTION (WHETHER BASED IN CONTRACT, INFRINGEMENT, NEGLIGENCE, STRICT LIABILITY, OTHER TORT OR OTHERWISE), SHALL EASY HEAT'S LIABILITY TO YOU AND/OR YOUR CUSTOMERS EXCEED THE PRICE PAID BY YOU FOR THE SPECIFIC GOODS PROVIDED BY EASY HEAT GIVING RISE TO THE CLAIM OR CAUSE OF ACTION. YOU AGREE THAT WE SHALL NOT BE LIABLE TO YOU OR YOUR CUSTOMERS FOR ANY INCIDENTAL, SPECIAL OR CONSEQUENTIAL OR PUNITIVE DAMAGES.** No agent, employee or representative of ours has authority to bind us to any affirmation, representation or warranty concerning the goods sold unless such affirmation, representation or warranty is specifically incorporated by written agreement.

To obtain new products, arrange repair of existing product, or a refund under this warranty, please contact Easy Heat with a description of the defect and proof of purchase at the address noted herein.

### DISCLAIMER

All information presented in this document was believed correct at the time of printing. We reserve the rights to make any modifications of this document without any prior notification.

#### USA

2 Connecticut South Drive  
East Granby, CT 06026  
Tel. (800) 537-4732  
Fax (888) 324-2440

#### CANADA

99 Union St.  
Elmira, Ont. N3B 3L7  
Tel. (519) 669-2444  
Fax (519) 669-6419



**USA**  
2 Connecticut South Drive  
East Granby, CT 06026  
Tel. (800) 537-4732  
Fax (888) 324-2440

**CANADA**  
99 Union St.  
Elmira, Ont. N3B 3L7  
Tel. (519) 669-2444  
Fax (519) 669-6419

[www.easyheat.com](http://www.easyheat.com)