

STANLEY[®]
Security Solutions

CYLINDERS



≡ SERIES

MORTISE AND RIM CYLINDERS



TABLE OF CONTENTS		Page			Page
1E Series features		2	Eurocylinders		7
1E Series specs/how to order		2	Cylinders and cams		8
1E Series rings/spindles/mortise/service equipment.....		3	1E Cylinder special rings		9
1E Series special cylinders		4, 5	5E Series specs/accessories		10
1E7J4/1E7K4 high security cylinders		6	5E Series how to order		11
Patented keying system		6			

1E SERIES — FEATURES

1E Mortise Cylinder

Standard mortise applications require use of BEST's 1E series cylinders with standard 1E-C4 cam. BEST cylinders may be altered to function with other manufacturers' locks by use of different cams (see page 8) and different cylinder rings (see page 9). Special cylinder variations are available for most applications (see pages 4 & 5). BEST cylinders are machined from brass or bronze bar stock and are available in a variety of finishes. Additional security is provided by a set screw that mounts diagonally in the cylinder wall and when tightened, holds the cylinder securely in the housing. BEST mortise cylinders feature the BEST interchangeable core and may be master-keyed into any existing BEST system. Contact your local Stanley Security Solutions sales office for information on special cylinder applications not listed in this catalog.



1E Rim Cylinder

Standard rim cylinder applications require the use of BEST's 1E rim cylinder series. BEST rim cylinders are interchangeable with other manufacturers' rim cylinders. BEST rim cylinders are machined from solid bar stock and are available in a variety of finishes. The standard package for the BEST rim cylinder includes cylinder, RP3 ring package, 1E-S2 spindle, clamp plate and clamp plate screws. BEST rim cylinders feature the BEST interchangeable core and may be master-keyed into any existing Best system.

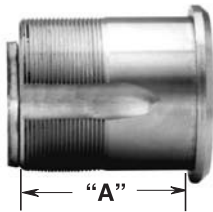

Specifications

Cylinder Nomenclature	Dimension "A"	Door Thickness
1E-64	1 1/8"	1 5/8" to 2 1/4"
1E-74	1 1/4"	1 7/8" to 2 1/2"

Cylinder diameter— 1 5/32"

To order: example: **1E74-C4-RP3-626**

Products covered by on or more of the following patents:
5,590,555 5,794,472

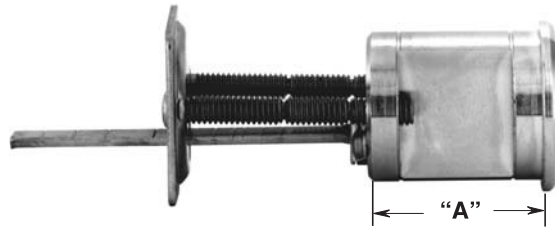

Specifications

Cylinder Nomenclature	Dimension "A"	Door Thickness
1E-62	1 3/16"	1" to 2 3/4"
1E-72	1 11/32"	1 1/4" to 3"

Cylinder diameter— 1 5/32"

To order: example: **1E72-S2-RP3-626**

HOW TO ORDER

STEP A	B	C	D	E	F	G	**
1E	7	4		C4	RP3	626	
Cylinder Diameter	Core Housing	Function Code Length	Standard Mortise Code	Cam or Spindle	Rings	Standard Finishes	
1E— 1 5/32" 3E— 1 1/2" 5E— see pages 10,11 8E— see page 7	0— dummy 6— 6 pin housing 7— 7 pin housing accepts all Best cores	2— rim 4— mortise* 6— tapered mortise see pages 4-5 for special cylinders	Blank— standard 22— 1 3/8" 24— 1 1/2" up to 96— 6" (see page 4-5)	C4— standard cam C181— Adams Rite MS cam S2— standard spindle (For special cams see page 8)	RP1— tapered cyl. RP2— 6 pin mortise RP3— std. package RP4— 3E mortise (For special rings see page 9)	605 606 612 613 622 625 626 690 Specify hand if required	

* For additional special mortise cylinders, see pages 4 and 5.

** Must specify keymark and number of keys or designate L/C for less core.



STANDARD RINGS

RP Standard Ring Package

The RP standard ring package includes a 1E-R3 ($\frac{3}{16}$ ") and 1E-R5 ($\frac{3}{8}$ ") ring.



RP1 Ring Package

The RP1 ring package for the 1E-76 cylinder includes a 1E-R2 ($\frac{1}{8}$ ") and 1E-R3 ($\frac{3}{16}$ ") ring.



RP2 Ring Package

The RP2 ring package for the 1E-64 cylinder includes a 1E-R2 ($\frac{1}{8}$ ") and 1E-R4 ($\frac{1}{4}$ ") ring.



RP3 Ring Package

The RP3 ring package for the 1E-62, 1E-72 and 1E-74 cylinders includes a 1E-R2 ($\frac{1}{8}$ ") and a 1E-R5 ($\frac{3}{8}$ ")

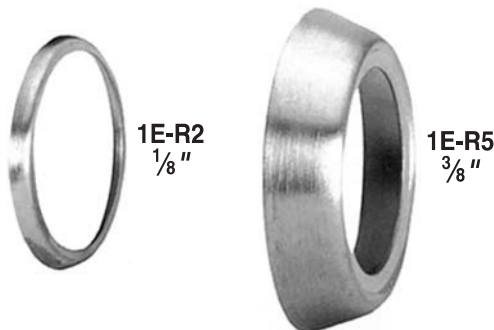

STANDARD CAM

Standard Cam for 1E-64, and 1E-74 Mortise Cylinders

Unless otherwise specified, the 1E-C4 cam is supplied on all 1E mortise cylinders.

Standard 1E-C4 Cam

Commonly used cams are listed on page 8.

If a cam other than the variety listed is needed, a sample cam should be forwarded to your local BEST office along with the lock manufacturer's name and lock series or identification number.

SPINDLES



1E-S2 Spindle (Steel) - A-40100-SH

1E-S3 Spindle (Bronze) - A-40100-Z

5" Spindle - A-54950; **$\frac{5}{32}$ " Spindle** - A-40101

The 1E-S2 flat spindle is supplied standard on all 1E rim cylinders. If marine application is necessary, request "marine construction" (1E-S3 bronze spindle and non-ferrous materials supplied). A five (5) inch spindle is available for thick door applications.

MORTISE SERVICE EQUIPMENT



ED211



ED212

ED211 Mortise Cylinder Wrench

The BEST mortise cylinder wrench and test handle is an essential dual-purpose tool. The double end is used primarily to install or remove BEST mortise cylinders without marring the cylinder surface finish. The single end may be used to test the lock operation, as well as align the throw pins.

To order specify: ED211 mortise cylinder wrench.

ED212 Mortise Cylinder Cam Assembly Tool

Mortise cylinder cams are quickly changed with the use of this tool. Approximate length $1\frac{3}{4}$ ".

To order specify: ED212 assembly tool.

ED221 Mortise Cylinder Thread Repair Die

Tool for re-threading $1\frac{5}{32}$ " diameter cylinders.

To order specify: ED221 thread repair die.

ED222 Cylinder Cam Testing Tool

Special cylinder /wrench assembly. Screws provide rapid means to install cams for testing.

To order specify: ED222 cam testing tool.

ED225 Hole Tap For $1\frac{5}{32}$ " Mortise Cylinder

Tap tool used to re-thread housing threads for 1E mortise cylinders.

A40095 Standard Throw Pins

SPECIAL CYLINDERS

Special Length Mortise Cylinders Specifications

Diameter: 1 5/32"

Uses: Special thickness doors

Length: See chart

Material: Solid brass or bronze

Cam: Standard 1E-C4 cam (see page 2) supplied unless otherwise specified.

Rings: The RP2 (for 6 pin) and RP3 (for 7 pin) package are supplied standard (page 2) unless otherwise specified.

To order: Designate desired length from chart under length code step "D" as shown (page 2).

Example: 1E-74-32



1E74

Mortise Cylinder Length Chart

Length "A"	Designate this number on step "D" of order procedure (page 2)	
1 3/8"	22	Riveted cams
1 1/2"	24	
1 5/8"	26	
1 3/4"	28	
1 7/8"	30	
2"	32	
2 1/8"	34	Screw-on cams
2 1/4"	36	
2 1/2"	40	
2 3/4"	44	
3"	48	
3 1/2"	56	
4"	64	
4 1/2"	72	
5"	80	
5 1/4"	88	
6"	96	

1 1/2" Diameter Mortise Cylinder Specifications

Diameter: 1 1/2"

Length: 6 pin-1 1/8"; 7 pin-1 1/4"

Door thickness:

6 pin-1 5/8" to 2 1/4" (includes trim)

7 pin-1 7/8" to 2 1/2"

Material: Solid brass or bronze

Cam: Standard 3E-C3 cam supplied unless otherwise specified.

Rings: The RP4 ring package is supplied with 3E cylinders. This package includes a 3E-R2 (1/8") and a 3E-R4 (1/4") ring.

To order: Designate "3E" on step "A" of order procedure (page 2) **Example:** 3E-74-C3-RP4-626

Options: 3E-04-Dummy, 3E-7A4-Turn knob, 3E-7B4-Dust Cover. Adaptor ring to allow 1E74 cylinders to fit a 3E tapped hole - A26139.



3E74

Taper Head Mortise Cylinder Specifications

Diameter: 1 5/32"

Length: 6 pin - 23/32"; 7 pin - 3/4"

Door thickness: 6 pin- 1 3/8" to 1 3/4" (including trim)

7 pin- 1 3/8" (including trim)

7 pin- 1 3/4" (without trim)

Material: Solid brass or bronze

Cam: Standard 1E-C4 cam supplied unless otherwise specified.

Rings: The RP1 ring package (page 2) is supplied standard with all 1E taper cylinders (page 2).

To order: See page 2. **Example:** 1E-76-C181-626



1E76

Dummy Mortise and Rim Cylinders Specifications

Diameter: 1 5/32"

Length: Mortise -1 1/8" ; Rim -1 1/8"

Material: Solid brass or bronze

Rings: Ring packages are supplied standard as follows: Mortise: RP2 ring package(see page 2) Rim: RP3 ring package (see page 3)

To order: Designate "0" on step "B" of order procedure (page 2) **Example:** 1E-02, 1E04-slot in back-1ESPL-6-B4619 1E04-slot in back-1ESPL-7-B4620, 1E02-slot in face-1ESPL-6-A5035, Special 1E04 with slot on back- 1ESPL-7-B4620. Special length 1E04 cylinders: 1 1/2"- 1ESPL-7-A9619 1 3/4"- 1ESPL-7-A20331



1E04



1E02

Turn Knob Cylinders Specifications

Diameter: 1 5/32"

Length: Mortise- 6 pin-1 1/8"; 1E6A4

Mortise- 7 pin-1 1/4" - 1E7A4

Rim- 6 pin-1 3/16" - 1E6A2

Rim- 7 pin-1 11/16" - 1E7A2

Material: Solid brass or bronze

Cam: Standard 1E-C140 cam supplied unless otherwise specified (see page 2).

Rings: Ring packages are supplied standard as follows (unless otherwise specified): Mortise 6 pin: RP2 ring package (see page 2)

Mortise 7 pin: RP3 ring package (see page 2) Rim 6 and 7 pin: RP3 ring package (see page 2)

To order: Designate "A4" on step "C" of order procedure (page 2). **Example:** 1E-7A4-C140-RP3-626 R-function turn knob cylinders, RH-1ESPL-7-B35401, LH-1ESPL-7-B35405 Special length cylinders 1.5"-1ESPL-7-A20336 1.75"-1ESPL-7- A20337, 2"- 1ESPL-7-B23409



1E7A4

Note: These should not be used in conjunction with deadbolt function BEST mortise locks. To order the old style "UP" thumb turn contact your local BEST dealer.

* Reference to Length "A" on Mortise Cylinder Length Chart.

Mortise and Rim Cylinders with Dust Covers Specifications

Diameter: 1 5/32"
Length: Mortise- 6 pin- 1 1/8"; **7 pin-** 1 9/32"
Rim- 6 pin- 1 3/16"; **7 pin-** 1 11/32"
Material: Solid brass or bronze
Cam: Standard 1E-C4 cam
 (see page 4) 1E series supplied unless otherwise specified.
Rings: Ring packages are supplied standard as follows (unless otherwise specified): **Mortise 6 pin:** RP2 ring package (see page 2), **Mortise 7 pin:** RP3 ring package (see page 2) **Rim 6 and 7 pin:** RP3 ring package (see page 2)
To order: Designate "B4" on step "C" of order procedure (page 2). **Example:** 1E-7B4-C4-RP3-626



1E7B4

Mortise Cylinder Direct Motion Cam Specifications

Diameter: 1 5/32", slabbed, threaded to the head
Length: 6 pin-1 5/16"; **7 pin-**1 15/32" From head to cam
Material: Solid brass or bronze
Cam: C228 - cabinet cylinder cam standard. Cam prevents key from being withdrawn in unlocked position.
Rings: The RP2 ring package is supplied standard for 6-pin and 7-pin unless otherwise specified (page 2)
To order: Designate "D4" on step "C" of order procedure (page 2). **Example:** 1E-7D4-C228-RP3-626
 To order with a utility cam lengths from 5/8" - 3 1/2"
1 3/4"- cylinder length (RH) 1ESPL-7-A10623 x C228
 (LH) 1ESPL-7-A10624 x C228
2 3/4"- cylinder length (RH) 1ESPL-7-A8774 x C228



1E7D4

Standard Mortise Cylinder Lost Motion Cam Specifications

Diameter: 1 5/32"
Length: 6 pin-1 1/8"; **7 pin-**1 1/4"
Material: Solid brass or bronze
Cam: 1E-C230 - cam supplied standard 1E-C230 is cam 1E-C4 (page 2) set up for lost motion. Specify cylinder handing as for hand and side of door.
Examples: RHO (Right Hand Outside); RHI (Right Hand Inside); LHO (Left Hand Outside); LHI (Left Hand Inside).
Rings: The RP2 ring package is supplied standard for 6-pin and 7-pin unless otherwise specified (page 2)
To order: Designate "F4" on step "C" of order procedure (page 2). **Example:** 1E-7F4-C230-RP3-626-RHO



1E7F4

Square Head Mortise Cylinder-Wrench Resistant For use in Narrow Stile Doors Specifications

Diameter: 1 5/32"
Length: 6 pin-1 1/4"; **7 pin-**1 13/32"
Material: Solid brass or bronze
Cam: As specified on order
 (see page 8 for cams available)
Rings: Package includes special 5/8" slip ring
To order: Designate "C4" on step "C" of order procedure (page 2)
Example: 1E-7C4-C181-R1010 (5/8" length)- 626
 Other length rings are available.



1E7C4

Slabbed Cabinet Mortise Cylinder Lost Motion Cam Specifications

Diameter: 1 5/32"
Length: 6 pin-1 1/8" (effective length)
7 pin-1 1/4" (effective length)
Material: Solid brass or bronze
Cam: C229- cam supplied unless otherwise specified (1E-C229, when ordered separate from unit). Specify hand: RH or LH
Rings: The RP2 ring package is supplied standard for 6 and 7-pin unless otherwise specified (page 2)
To order: Designate "E4" on step "C" of order procedure (page 2).
Example: 1E-7E4-C228-RP3-626-RH
Special Length:
 2" cylinder length (1 1/4" effective length)
 RH-1ESPL-7A-9580; LH-1ESPL-7-A9577
 2 1/4" cylinder length (2" effective length)
 RH-1ESPL-7-A8813; LH-1ESPL-7-A8812



1E7E4

Hotel/Motel Mortise Cylinder Shifting Cam Specifications

Diameter: 1 5/32"
Length: Mortise 6 pin-1 5/16"; **7 pin-**1 15/32"
Material: Solid brass or bronze
Cam: C258 or cam supplied as specified (see page 8)
Rings: The RP2 ring package is supplied standard for 6-pin and 7-pin unless otherwise specified (page 2)
To order: Designate "G4" on step "C" of order procedure (page 2).
Example: 1E-7G4-C258-RP3-626



1E7G4

1E HIGH SECURITY CYLINDERS

1E7J4 – 1E7K4 Cylinder Features

Designed for high security applications, BEST offers the 1E7J4 high security cylinder and special 5C interchangeable core. This special cylinder is listed by Underwriters Laboratories as meeting UL437 standard for key locks. The patented cylinder provides additional strength through a hardened stainless steel alloy ring, face and keyway disc. It can be masterkeyed into any BEST masterkey system. Cylinder also conforms to ANSI A156.5 mortise cylinder, Grade 1A. The 1E7J4 cylinder must be combined at the factory. The 1E7K4 cylinder is available where UL listing is not a requirement, and can be ordered uncombined.

Note 1: The 1E7J4 cylinder meets UL437 standards only when used with a 36H/37H mortise case.

Note 2: Both 1E7J4 and 1E7K4 require long blade key for operation.



1E7J4 High Security Cylinder

1E7J4 – 1E7K4 Cylinder Specifications

Diameter: 1 ⁵/₃₂". 1.150-32 (NS-2A) threaded mortise cylinder.

Mounting length: 7 pin– 1 ¹/₁₆".

Material: Brass (cylinder) and stainless steel ring.

Finish: 630 (nickel plated satin stainless steel material).

Cylinder rings: High security wrench resistant, machined from stainless steel, hardened, and nickel plated. Special door preparation required. Diameter of hole 1 ³/₄".

Cylinder face, Keyway disc.: Stainless steel, hardened

Cam: Supplied with C258 cam. See page 8 for special cams.

To order: Designate "J4" or "K4" on Step "C"order procedure. (see page 2.)



1E7K4 High Security Cylinder

MX8 – PATENTED KEYING SYSTEM

One of the greatest threats to key control within your facility is the unauthorized duplication of keys; one simple solution is the use of the MX8 Patented Keying System by Stanley-Best Access Systems a patent-protected keying system.

Very seldom can a single product meet all of your exact needs, and often your level of convenience must be sacrificed to fit the capabilities of the product. The MX8 Patented Keying System provides you with an significant amount of flexibility, enabling a solution that fits your unique balance between security and convenience.

The MX8 Patented Keying System is available in two series of keyways, the M Series and the X Series. Each series offers a different blend of features to help you maximize convenience while optimizing your security.

The MX8 Patented Keying System has the ability to provide geographic exclusivity to the customer.



MX8 Key & Core

M Series Keyway Features

- Patented keys operate both MX8 and Standard BEST cores (backward compatibility) with existing BEST keyways (JKLM only). Standard keys do not operate MX8 cores.
- Available in large bow, long blade, and long nose key blanks to work with special applications.
- Available in core designs for use in special application locks, such as high security mortise, hotel cylinders, and glass display-case locks.
- Utilizes the same combining kits and key cutting equipment as the Standard BEST keyways.
- M Series keys operate MX8 cores and Standard (non-patented) BEST cores. Standard key blanks do not operate MX8 cores.

X Series Keyway Features

- Distinctive key design includes thicker key blanks with larger bow for added strength and easier handling.
- Keyways are unique to MX8 Patented Keying System offering even higher key duplication protection.
- Requires only minor modifications to key cutting equipment to accommodate new keyways. X Series keyways utilize the standard combining kit, minimizing the expense of system changeover.
- X Series keys only operate MX8 cores.

SPECIAL EUROPROFILES

Mortise locksets from a number of different international manufacturers can be incorporated into your BEST masterkeyed system by replacing the cylinder with a Best Eurocylinder and 3C European interchangeable core. When ordering, please specify the lock manufacturer's name and their model number. Some Euro profile cylinders will accept Best standard core rather than the 3C core. Please specify the "E" option when ordering standard cores for use in Eurocylinders.

The most popular of the European adaptations is for the Europe an cylinder. Best Access Systems order nomenclature and several required critical dimensions are listed below. Please specify, as requested when ordering.



8E7E5– Europrofile*
(* Requires use of 3C core)

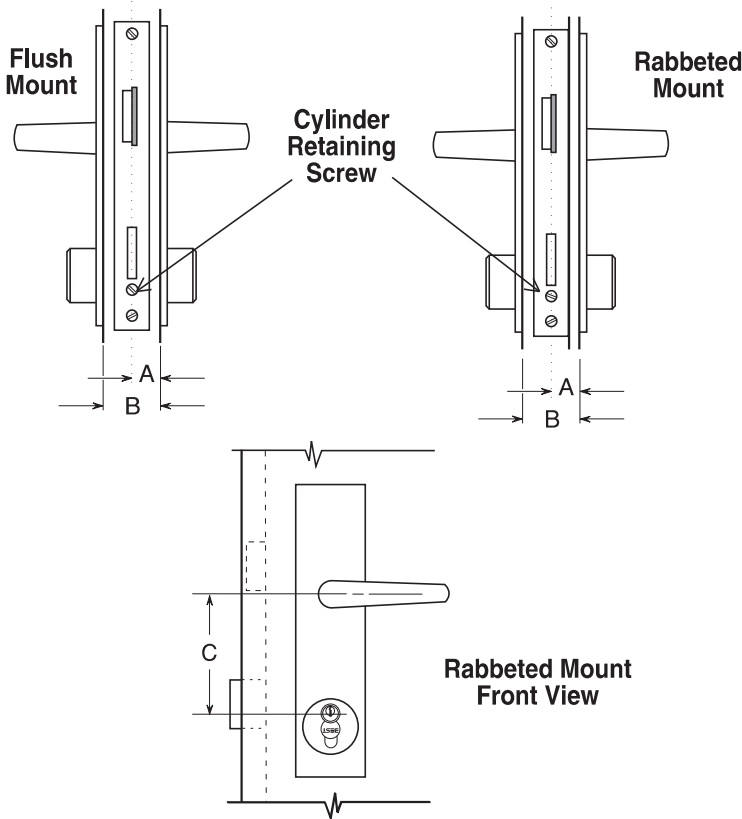

8E7H6– for locks manufactured in Germany



3C– European Core

Critical Dimensions - Europrofile

- “A”– Dimension to center of lockset case. Determined by measuring from set screw location to outside of door face.
- “B”– Door thickness.
- “C”– Dimension from center of key rotation to center of handle rotation, if other than 72mm. Maximum allowed– 114mm. Minimum allowed– 37mm

HOW TO ORDER: EUROPROFILE

8E7E5	25mm	45mm	65mm	Keyed Alike	619
Eurocylinder	“A” Dimension	“B” Dimension	“C” Dimension	Keying Instructions	Finish: 619 - Satin Nickle Plated 626 - Satin Chrome Plated

CYLINDERS AND CAMS

Special cams are available which will operate most mortise locksets, regardless of make or function. With these cams, your masterkeyed system can be extended through the use of replacement cylinders with cams similar to those being used. A few of the cams are illustrated. Other designs are available upon request. All cams available are designed for use on BEST mortise cylinders.

WARNING— Best Access Systems desires to provide up-to-date and reliable product adaptation uses. However, BEST cannot guarantee the quality of other manufacturers' locksets. In addition, other lock manufacturers' may make changes to their product that affect the operation and compatibility of our core and cylinder adaptation. When this occurs, those manufacturers' have no obligation to notify BEST. If you are using a BEST cylinder in another manufacturers' lockset and find that it does not operate properly for any reason, please contact your local BEST sales office immediately.

NOTE: Cams not drawn to scale

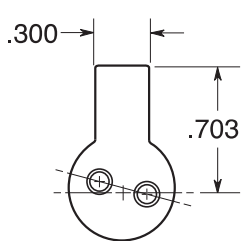

C4

(when ordered with cylinder, step E, page 2) **1E - C4** (for cam only)

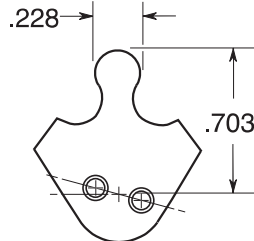

C118

(when ordered with cylinder, step E, page 2) **1E - C118** (for cam only)

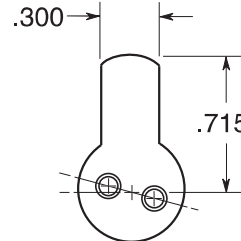

C127

(when ordered with cylinder, step E, page 2) **1E - C127** (for cam only)

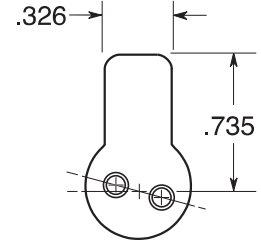

C128

(when ordered with cylinder, step E, page 2) **1E - C128** (for cam only)

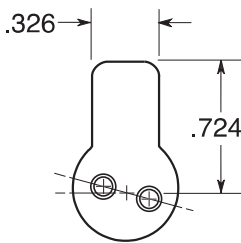

C129

(when ordered with cylinder, step E, page 2) **1E - C129** (for cam only)

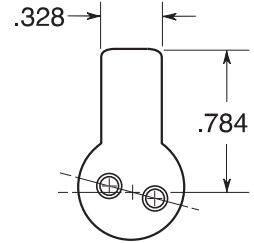

C136

(when ordered with cylinder, step E, page 2) **1E - C136** (for cam only)

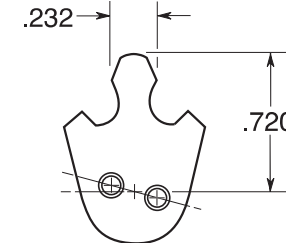

C161

(when ordered with cylinder, step E, page 2) **1E - C161** (for cam only)

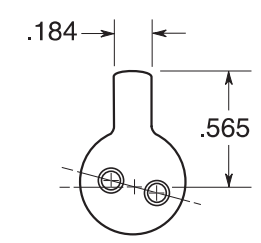

C181

(when ordered with cylinder, step E, page 2) **1E - C181** (for cam only)

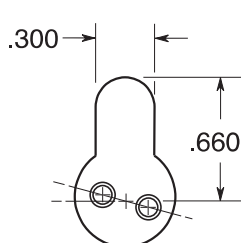

C191

(when ordered with cylinder, step E, page 2) **1E - C191** (for cam only)

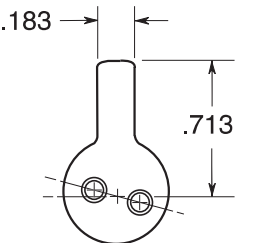

C208

(when ordered with cylinder, step E, page 2) **1E - C208** (for cam only)

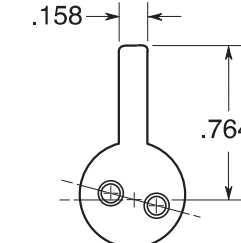

C210

(when ordered with cylinder, step E, page 2) **1E - C210** (for cam only)

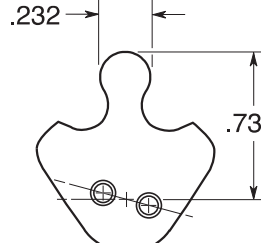

C258

(when ordered with cylinder, step E, page 2) **1E - C258** (for cam only)

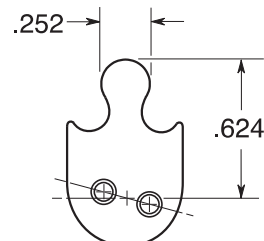

C265

(when ordered with cylinder, step E, page 2) **1E - C265** (for cam only)

NOTE: While certain functions may require a different cam, in general the following cams will work for these common applications.

- | | |
|--------------------------------|---------------------------------|
| C4.....Standard cam | C191....Best mortise (latch) |
| C127....Arrow mortise (latch) | C208....Sargent |
| C161....Corbin-Russwin mortise | C258....Best mortise (deadbolt) |
| Arrow mortise (deadbolt) | C265....Schlage L mortise |
| C181....Adams Rite | |

1E-R7 RING CHART

Overall Length Available	Nomenclature if Ordered With Cylinder (see step "F" page 2)	Nomenclature if Ordered Without Cylinder
1/8"	R702	1E-R702
3/16"	R703	1E-R703
1/4"	R704	1E-R704
5/16"	R705	1E-R705
3/8"	R706	1E-R706
7/16"	R707	1E-R707
1/2"	R708	1E-R708
9/16"	R709	1E-R709
5/8"	R710	1E-R710
11/16"	R711	1E-R711
3/4"	R712	1E-R712



1E-R7 Straight Ring

Specifications - 1E-R7

To be used with BEST 1E series (1 5/32") Cylinders.

Dimensions– inside diameter- 1 5/32", outside diameter 1 5/16" length-see chart at left.

Material– solid brass or bronze

Finish– available in 605, 606, 612, 613, 625 and 626

1E-R8 RING CHART

Overall Length Available	Nomenclature if Ordered With Cylinder (see step "F" page 2)	Nomenclature if Ordered Without Cylinder
1/8"	R802	1E-R802
3/16"	R803	1E-R803
1/4"	R804	1E-R804
5/16"	R805	1E-R805
3/8"	R806	1E-R806
7/16"	R807	1E-R807
1/2"	R808	1E-R808
9/16"	R809	1E-R809
5/8"	R810	1E-R810
11/16"	R811	1E-R811
3/4"	R812	1E-R812
13/16"	R813	1E-R813
7/8"	R814	1E-R814
15/16"	R815	1E-R815
1"	R816	1E-R816



1E-R8 Tapered Slip Ring- Wrench Resistant

Specifications - 1E-R8

To be used with BEST 1E series (1 5/32") Cylinders.

Dimensions– inside diameter - 1 5/32", inside rim counter-bored to protect cylinder head. Outside diameter - tapered 1 1/2" to 1 29/64" length-see chart at left.

Material– solid brass or bronze

Finish– available in 605, 606, 612, 613, 625 and 626

UTILITY CYLINDER LOCK

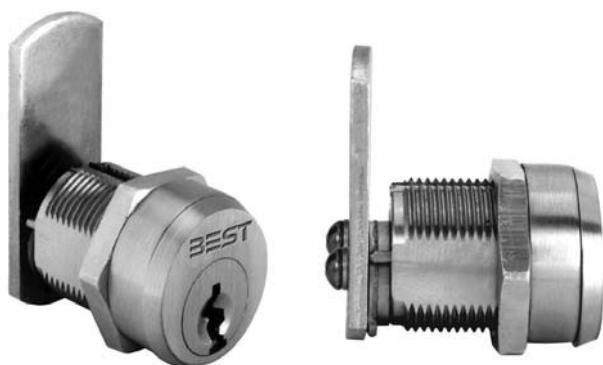

5E- 3/4" Cylinder

Specifications

The 5E utility cylinder lock fits standard 3/4" diameter cylinder installations such as wood or metal desks, file cabinets, vending machines, utility and storage cabinets, elevators and security alarm control panels. The complete 5E assembly includes a combined 3/4" cylinder with cam, hex nut, lock washer and spacer collar.

Maximum mounting surface thickness— 5E utility cylinder locks may be mounted on surfaces with the following maximum thickness: **5E6**— 1 1/16", **5E7**— 27/32"

Keying— May be keyed individually, keyed alike or masterkeyed into a new or existing Best standard masterkeyed security system.

Service— 5E cylinders may be recombined and serviced onsite. Special service equipment is available (see Service Equipment Section of Best catalog).

Finish— 626 satin chrome only

5E Combining and Service Accessories

Nomenclature	Item
A-8049	5E 3/4" Hex Nut
A-21068	Washer for cylinder body head
A-4845	Cam Screws
A-4045	Lock washer for cam screws
5ED261	5E capping block
5ED253	5E thread tap - 3/4" x #24
5ED254	5E 3/4" metal punch and die set (slab)
5ED262	5E cap depressor
5ECP6	Slide cap - 6 pin
5ECP7	Slide cap - 7 pin
5ES1	5E springs

***NOTE:** The 5E lock is not available for Premium and Peaks keying systems.

Refer To The Following Procedure When Ordering
See Order Example At Bottom Of Next Page.

A Cam Motion and Degree of Rotation

When ordering 5E cylinders, specify the cam motion type and degree of rotation. Available cam motion types are listed below. Different type motions are limited to different degrees of key rotations.

Type A— Direct motion - Key and cam rotation is direct. Key may be removed in locked position only. Motion is 360 degrees right or left.

Type B— Limited motion - Key and cam rotation is direct. Key may be removed in locked position only. Motion is limited to 90 degrees or 180 degrees right or left.

Type C— Lost motion. Cam rotates 90 degrees right or left. Key rotates 360 degrees. Key removal with cam in locked or unlocked position.

Type D— Throw member drive - Key and drive motion is direct. Key may be removed in locked position only. Motion is 360 degrees right or left.

B Determine Ring Length

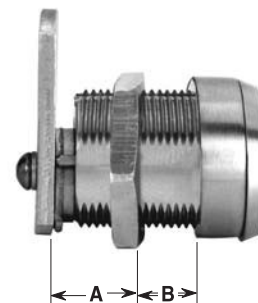
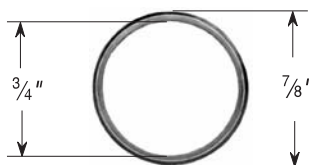

A spacer collar may be required to position the cam for proper lock operation. The spacer collar is installed between the 5E cylinder head and the mounting surface. To determine the proper length of the spacer collar, add together: the desired distance from the cam to the inside of the mounting surface ("A" above) to the measured thickness of the mounting surface ("B" above). Then, subtract this total from: 3 1/32" when installing a 5E6, or 1 1/8" when installing a 5E7. The remainder is the collar length, which is illustrated.

To properly order spacer collars, designate the following nomenclature for the length desired:

5E Spacer Collar Length Chart

Length	Nomenclature	To order separately
1/16"	R701	5E-R701
1/8"	R702	5E-R702
3/16"	R703	5E-R703
1/4"	R704	5E-R704
5/16"	R705	5E-R705
3/8"	R706	5E-R706
7/16"	R707	5E-R707
1/2"	R708	5E-R708

5E SERIES

C Select Proper Cam Type

Cam

Cams for 5E cylinders are available with a number of variations to suit the particular application as required. Two major variations that must be designated on the order are: A.) The cam type, and B.) The cam length.

Cam Types

The following cam types are available for the Best 5E cylinder. Other designs are available upon request. (See page 8)



C1 Straight Cam Fixed Motion
C3 Straight Cam Lost Motion
4A&4B Offset Cam Lost Motion
2A&2B Offset Cam Fixed Motion

Cam Types Defined (Listed relative to motion/rotation)

C1– Straight cam mounted for fixed motion operation (used in conjunction with type “A” and type “B” motions). To order cam separately, designate 5E-C1 and length from code chart at option D.

C3– Straight cam mounted for lost motion operation (used in conjunction with type “C” cam motions). To order cam separately, designate 5E-C3 and length from code chart at option D.

2A– Offset cam (inward mount) for lost motion operation (used in conjunction with type “A” and type “B” motions). To order cam separately, designate 5E-C2A and length from code chart at option D.

2B– Offset cam (outward mount) for fixed motion operation (used in conjunction with type “A” and type “B” motions). To order cam separately, designate 5E-C2B and length from code chart at option D.

4A– Offset cam (inward mount) for fixed motion operation (used in conjunction with type “C” cam motions). To order cam separately, designate 5E-C4A and length from code chart at option D.

4B– Offset cam (outward mount) for lost motion operation (used in conjunction with type “C” cam motions). To order cam separately, designate 5E-C4B and length from code chart at option D.

D– Direct throw member drive and tailpiece. Throw pins engage cylinder to flat spindle tailpiece. The standard flat spindle tailpiece is 1 1/16” and may be cut to length desired. To order spindle separately, designate 5E-D.

D Determine Cam Length

Cam length is determined by measuring from center of the cam rotation to the tip of the cam.

Straight Cam

Length	Code #
5/8"	10
3/4"	12
7/8"	14
1"	16
1 1/4"	20
1 1/2"	24
2"	32
2 1/2"	40
3"	48
3 1/2"	56

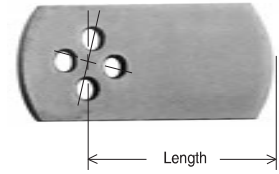

Offset Cam

Length	Code #
1 1/16"	17
1 5/16"	21
1 13/16"	29
2 5/16"	37
2 13/16"	45

E Cam Mounting Position and Cam Direction

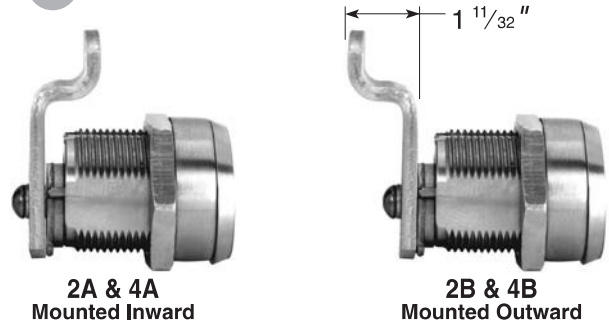

Direct Throw Member Drive and Tailpiece

Cams may be mounted in one of four "clock" positions as pictured below. Designate cam mounting and rotation direction (right-"R" left-"L"). Key is only removable in the locked position, unless ordering type C. (Available in locked and unlocked positions.)

3 o'clock = 3
6 o'clock = 6
9 o'clock = 9
12 o'clock = 12

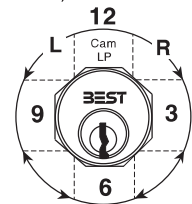

HOW TO ORDER

5E	7	A	1	C	R708	4B	20	12	R	90	626
Series	Lock Body	Keyway	Combining Code	Cam Motion	Ring Length	Cam Type	Cam Length	Mouting Position	Cam Direction	Degree of Rotation	Finish
5E-3/4"	6-6 pin 7-7 pin	designate specific keyway (A,E etc.) see note page 10.	1– uncomb. 2-A2 system 3-A3 system 4-A4 system	A-direct B-limited C-lost D-throw member drive (see A page 10)	R701- 1/16" R702- 1/8" R703- 3/16" R704- 1/4" R705- 5/16" R706- 3/8" etc. (see B page 10)	C1-fixed straight 2A-fixed offset in 2B-fixed offset out C3-lost motion 4A-lost motion offset in 4B-lost motion offset out D-direct (see C above)	10- 5/8" 12- 3/4" 14- 7/8" 16- 1" etc., in 1/16" of an inch (see D above)	3– 3 o'clock 6– 6 o'clock 9– 9 o'clock 12– 12 o'clock (see E above)	R– right L– left (see E above)	90– 90° 180– 180° 360– 360° (see A page 10)	626 standard

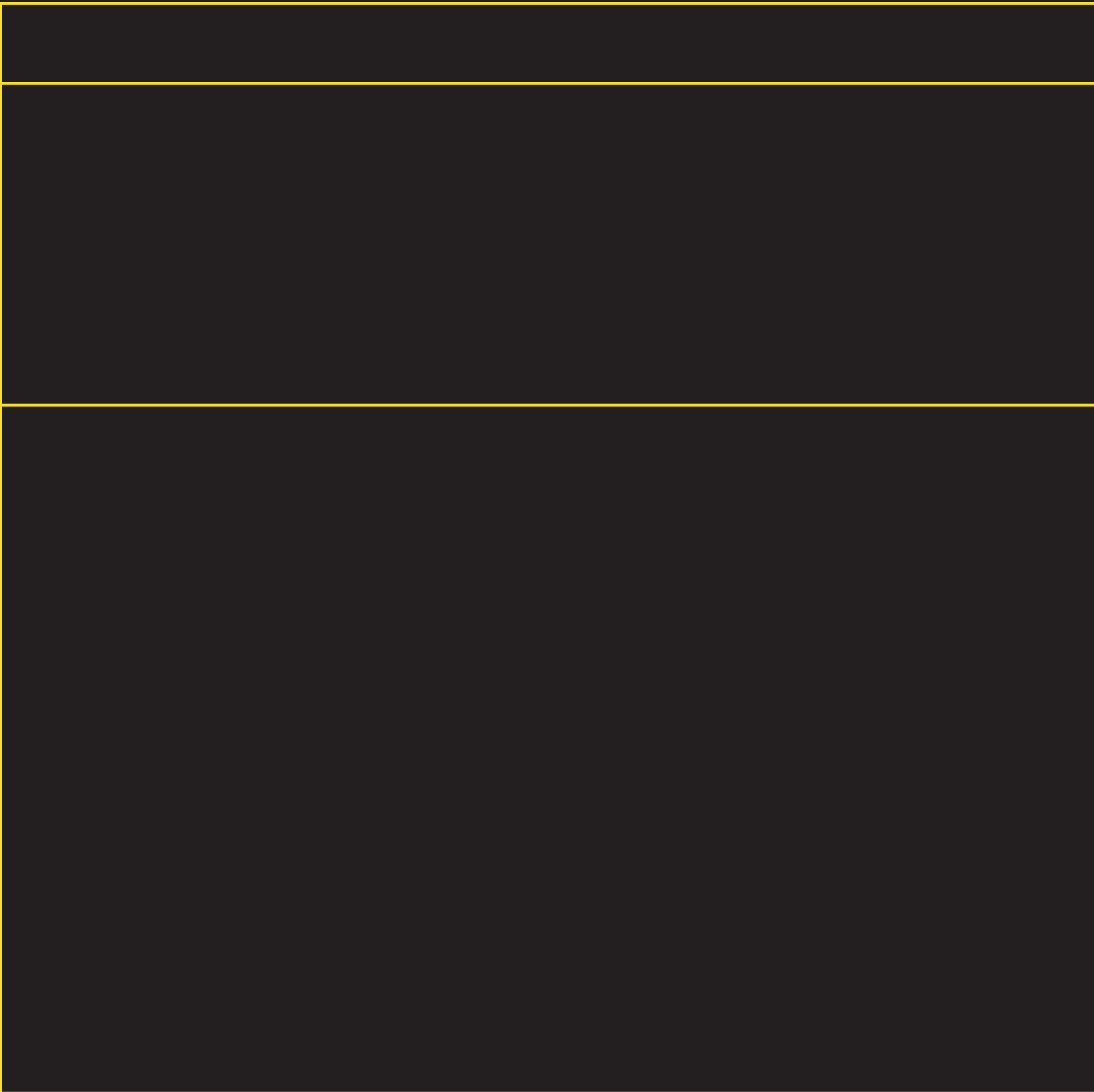

For more information on Stanley Security Solutions' products, services, and office locations visit our web site at www.stanleysecuritysolutions.com

Product information contained in this catalog has been compiled and presented with as much care and completeness as is reasonably possible. Errors or mistakes may be present, and in many cases, reliance has been placed on information supplied by other manufacturers which may be in error or which may be subject to changes or modifications by the manufacturer without notice and without obligation. Therefore, no guarantee can be made or should be assumed or implied with regards to product information contained in this catalog.



Stanley Security Solutions, Inc.

6161 E. 75th Street Indianapolis, Indiana 46250

www.stanleysecuritysolutions.com

© 2009 Stanley Security Solutions, Inc. and Stanley Logistics

10M 709FP
BAS030