



Detex Corporation, 302 Detex Drive, New Braunfels, Texas 78130-3045
830-629-2900 / 800-729-3839 / Fax 800-653-3839 / Text photos only: 830-481-6433 / INTERNET: www.detex.com

**INSTALLATION INSTRUCTIONS FOR ADVANTEX MORTISE LOCK 30 & F30 SERIES DEVICE
& "W" (Weatherized) MODELS**



Drawing #: 103200 (SS)
104695 (AL)

U.S. PATENT NUMBERS:

6009732

6205825B1

6532777B2

INTERNATIONAL PATENT NUMBER:

PCT6009732

Table of Contents	Page
Device parts breakdown view.....	2
Device parts breakdown list with part numbers.....	3
Hardware List with part numbers & tools required.....	4
Door prep & OKC installation (if required).....	5
Install Mortise lock, backplate, strike and device.....	6
Check for device clearance, level device.....	7
Troubleshooting & optional accessories.....	7

Should you have a Question/Problem with your Detex device please call Detex Technical Support from the job site at 1-800-729-3839 and choose option 2 on our menu. Please do not return the product to the distributor.

**For WARRANTY information,
scan code below or
go to www.detex.com/warranty**



**For device installation videos,
scan code below or
go to www.detex.com/vidoes**

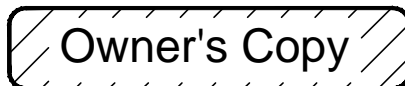

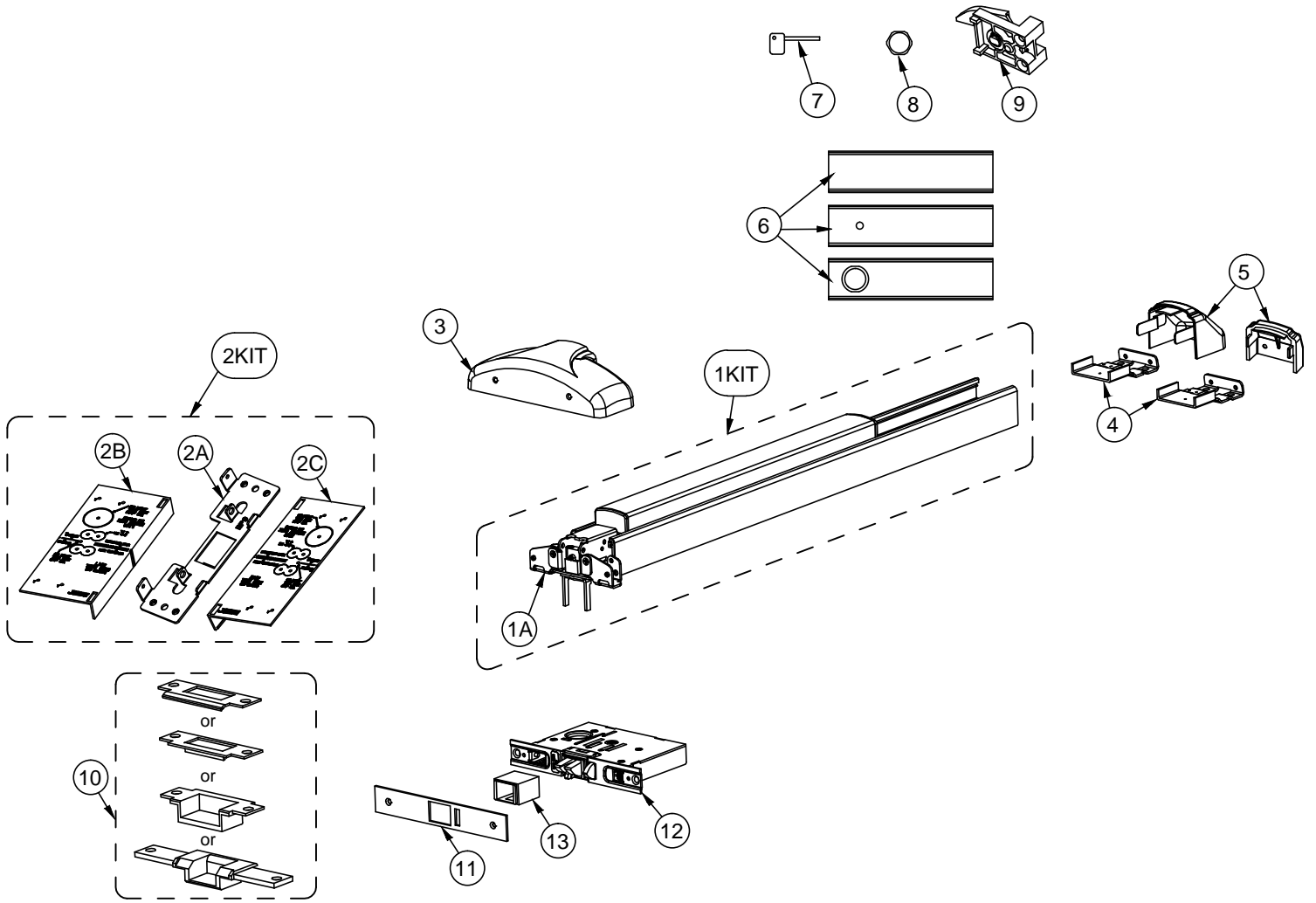





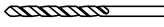
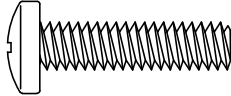
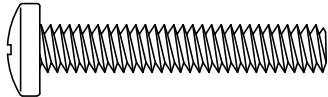

PARTS BREAKDOWN		
Item	Order Part #	Description
1KIT	105500-X	Centercase/Pushpad SubAssembly (includes 1A)
1A	100698-2	Centercase Assembly, Wide Stile
2KIT	103806-9	Mounting Plate/Strike Locator Kit, Mortise (includes 2A, 2B & 2C)
2A	103215	Mounting Plate, BP9
2B	103284	Template, RHR, Mortise
2C	103285	Template, LHR, Mortise
3	102353-1	Centercase Cover, Stainless Steel, Wide, 10 series, 630
	104601-1	Centercase Cover, Aluminum, Wide, 10 series, 628
4	100147	Endcap bracket for EC1 (ramped) endcap w/o battery holder
	101093	Endcap bracket for EC1 (ramped) endcap w/ battery holder
	104303	Endcap bracket for EC2 (flush) endcap w/o battery holder
	104636	Endcap bracket for EC2 (flush) endcap w/ battery holder
5	101642-9	Endcap, EC1 (ramped) Stainless Steel, 630
	104304-9	Endcap, EC2 (flush) Stainless Steel, 630
	104612-1	Endcap, EC2 (flush) Aluminum, 628
6		Fillerplate, Subassembly, S&R, Less Dogging, LD, 10 series, 36"
		Fillerplate, Subassembly, S&R, Hex Dogging, HD, 10 series, 36"
		Fillerplate, Subassembly, S&R, Cylinder Dogging,CD, 10 series, 36"
7	100450	Hex Key (for Hex Dogging)
8	100783	Cylinder Nut (for Cylinder Dogging)
9	102216-2	Hex Dogging Assembly
	102216	Cylinder Dogging Assembly
10	103285-X	Strike Kit, ANSI (includes hardware)
	103294-X	Strike Kit, ANSI, flat lip (includes hardware)
	103286-X	Strike Kit, Double door, short open back (includes hardware)
	103289-X	Strike Kit, Double door, long open back (includes hardware)
11	103203-X	Front plate
12	103320-1	Mortise lock, standard
	103320-2	Mortise lock, EE
	103320-3	Mortise lock, ES
13	103273	Latchbolt block

Your particular part or configuration may not be shown:
Contact Detex technical support at 800-729-3839 (option 2)

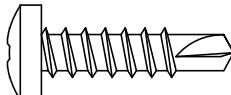
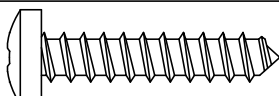
**Hardware Table for BASIC device mounting.
Additional hardware is provided per the device configuration**

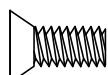
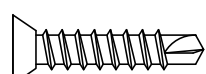
	Fastener Part No	Drill Bit 
	P/N: 100980 1/4-20 x 1" PPH	#7 or 13/64"
	P/N: 100954 1/4-20 x 1-1/2" PPH	#7 or 13/64"
	P/N: 101621-5 1/4-20 x 1/4" PPHMS	#7 or 13/64"
	P/N: 101632-2 10-32 x 5/16" PFHUMS (multiple finishes included)	-----
	P/N: 100162-106 6-32 x 3/8" PFHUMS (multiple finishes included)	-----
	P/N: 103276-63 #14 x 1" PPH self-drilling	1/8 pilot hole recommended for self-drilling screws
	P/N: PP-5183-110 #14 x 1-1/4" PPH wood screw	1/8 pilot hole recommended for wood screws
	P/N: PP-5067-25 #14 Lockwasher	
	P/N: 100156-108 #8-32 x 1/2 "	-----
	P/N: PP-5802-118 12-24 x 1/2"	-----
	P/N: 103253-52 #12 x 1" self-drilling	-----

Tools Required:

- | | | |
|---|---|---|
| <p>Safety Glasses</p> <p>Power Drill</p> <p>Tape Measure</p> <p>Level</p> | <p>Pencil</p> <p>Hammer</p> <p>Pliers</p> <p>1/4-20 Tap</p> | <p>Phillips & small flat Screw Drivers</p> <p>Combination Square</p> <p>Center Punch</p> <p>Saw for cutting device if necessary (chopsaw preferred)</p> |
|---|---|---|

STEP 1: DOOR PREP (Note: LHR installation shown)

Use plastic template to mark and drill mortise lock and backplate holes

Door prepared to ANSI A115.13
See T2000 (metal) and T2001 (wood) templates

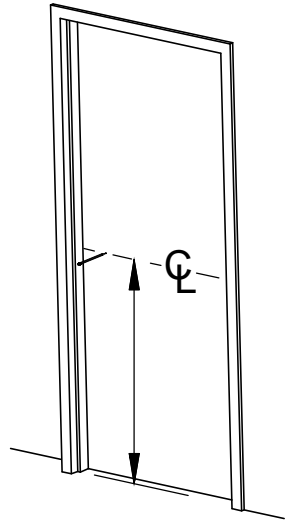

Mark centerline for device
40" above finished floor

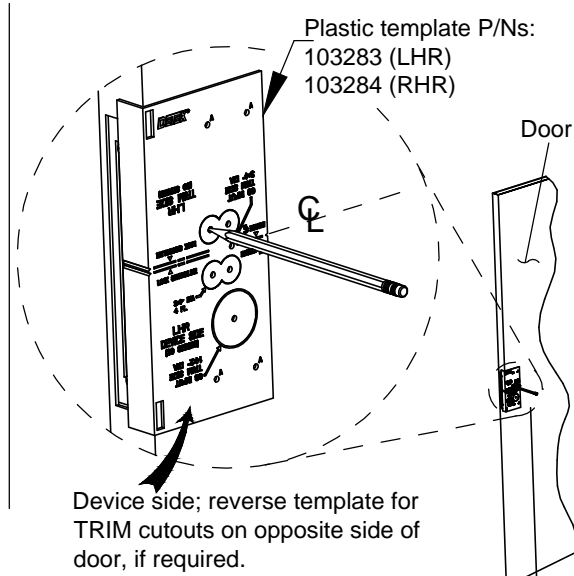

Mark backplate holes

Mark mortise access holes

Lock Centerline

LHR Device Side

Mark backplate holes

2-3/4" Backset

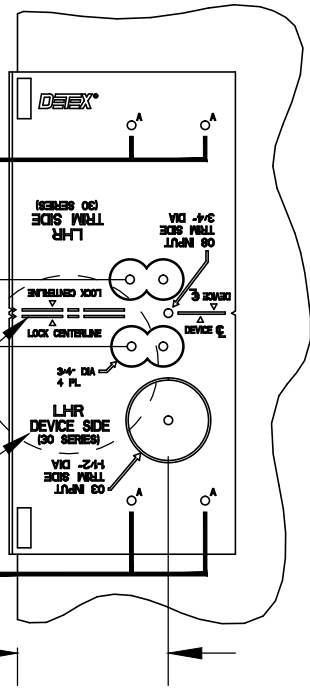

NOTES:

- 1) File sharp corners to complete slots where needed.
- 2) See Trim instructions where applicable for drilling trim holes.
- 3) See electrical instructions for wiring electrical devices.

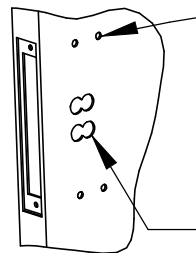

Drill for "A" or "F" screws (4 places)

OR

Use #14 self-drilling "K" screws (4 places)

OR

Drill 5/16" diameter

(For trim option only, 4 places)

AND

3/4" diameter 4 places

STEP 2: INSTALLING OKC (03) FUNCTION (if not required, skip to STEP 3)

Use plastic template to mark and drill hole (Trim side only)

CAUTION!

Mortise lock **NOT** installed for this step

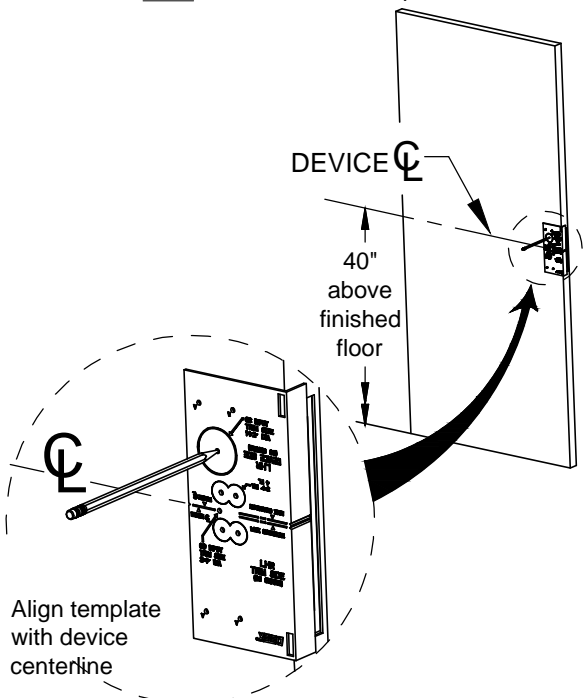

Drill 1-1/4" dia, one side

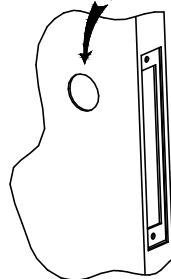

Install lock with (2) screws.
Fasten screws loosely.

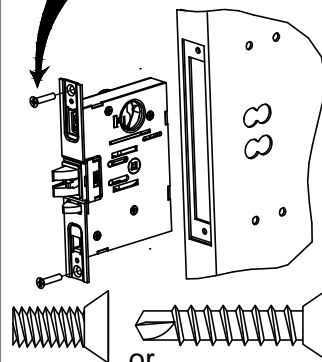

Install cylinder AFTER lock is installed

Turn cylinder CW

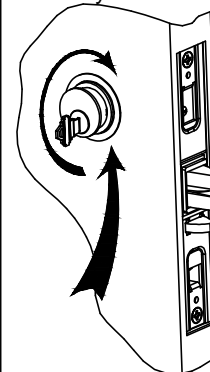

Cylinder and collar NOT supplied, but can be ordered separately.
Cylinder P/N: 102281-X
Collar P/N: 103303

Tighten screws

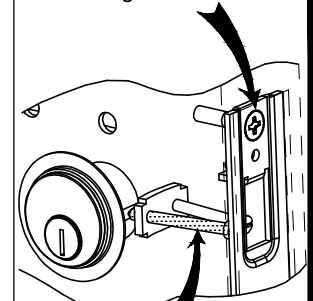

Tighten screw nearest cylinder side of door only

Continue with Step 3

STEP 3: INSTALL MORTISE LOCK

Install mortise lock
Install lock with (2) screws

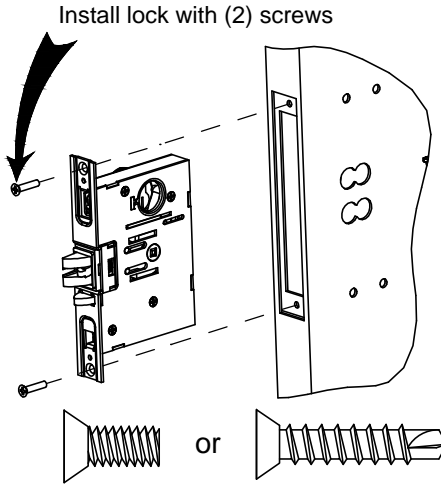

To change lock HANDING:
Remove block and rotate latchbolt

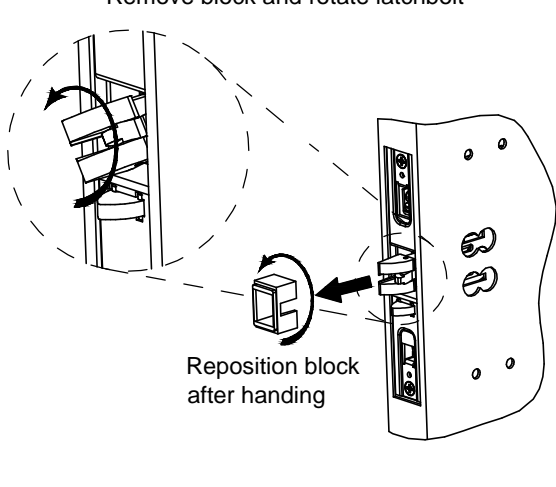

Reposition block after handing

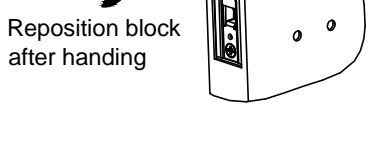

Install plate with (2) screws

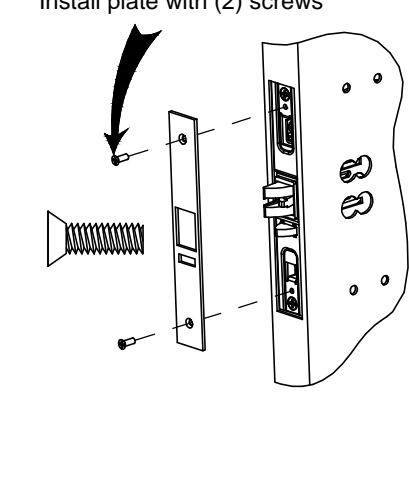

or

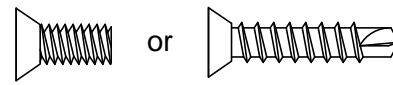

STEP 4: INSTALL BACKPLATE

Install backplate & trim for outside key control
Drill for 1/4"-20 or #14 screws or use #14 self-drilling screws, 4 places

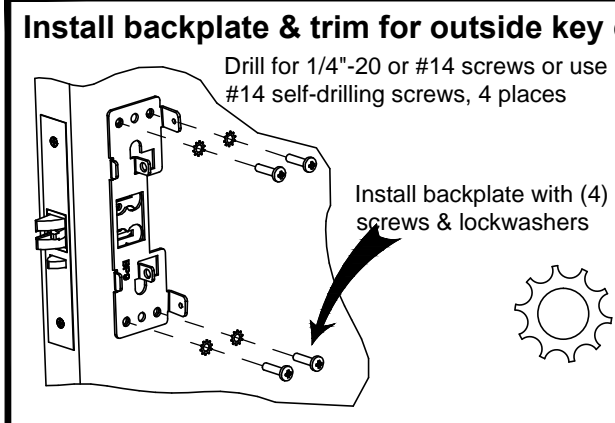

Install backplate with (4) screws & lockwashers



NOTE: See Trim instructions where applicable

STEP 5: INSTALL STRIKE

Install Strike
Install strike with (2) screws

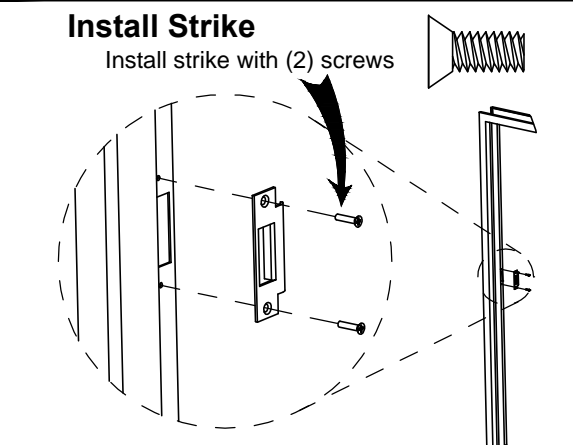

STEPS 6-8: INSTALL DEVICE

6 Install device to backplate
Align fingers with mortise lock in door

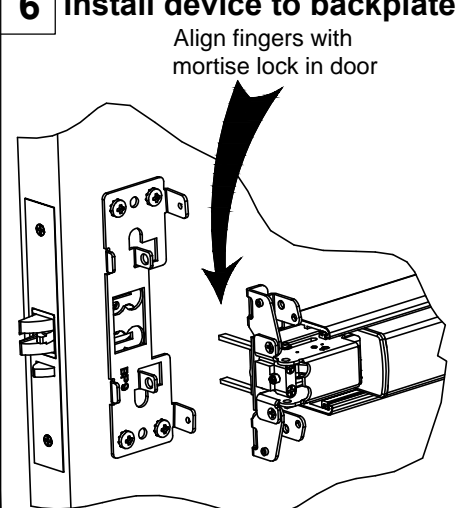

IMPORTANT!

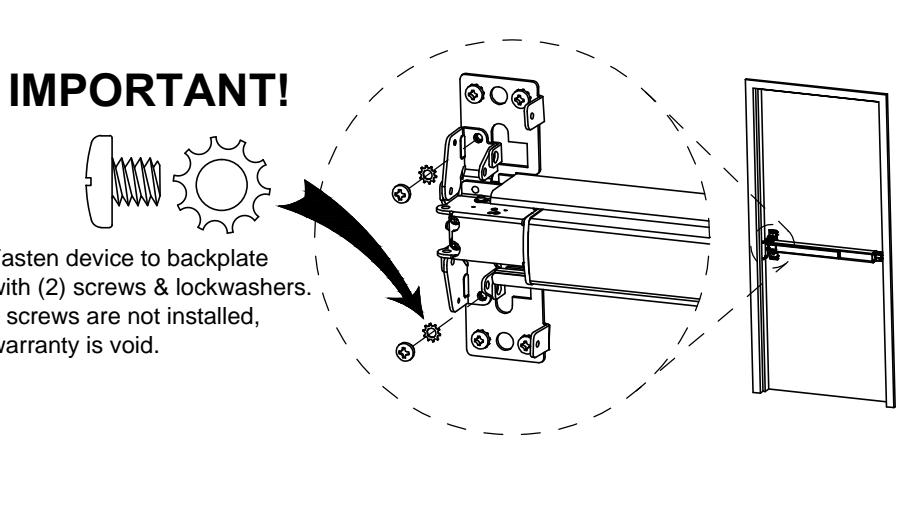

Fasten device to backplate with (2) screws & lockwashers. If screws are not installed, warranty is void.

Slide endcap assembly onto extrusion

CHECKING FOR DEVICE CLEARANCE (Cut-Off procedure if required)

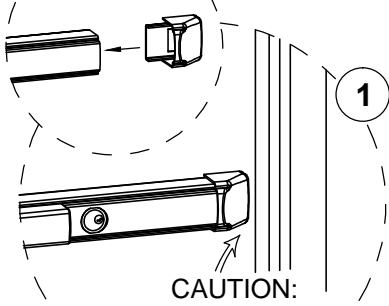

CAUTION:

Check for device and door frame clearance.
If no cut-off needed, proceed to the next page.

Minimum Fillerplate Length	
Type	Length (L)
LD	2-1/2"
HD/CD	3"

2 Cut fillerplate and extrusion STRAIGHT & SQUARE to desired length and deburr

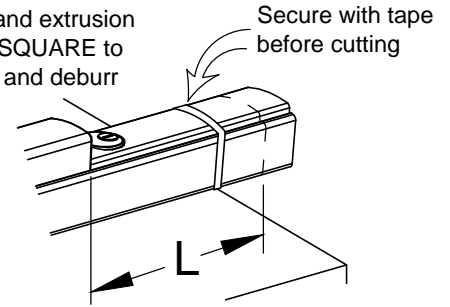

For aluminum Advantex finish cutdown applications: After cutting, the baseplate extrusion can be reversed to place the cut end inside the head cover. To do so, loosen the setscrew inside the aluminum baseplate extrusion and slide extrusion out, reverse, & slide back in. Tighten setscrew.

7 Level device and install endcap bracket

Mark & Drill for 1/4"-20 or #14 screws or use #14 self-drilling screws
2 places

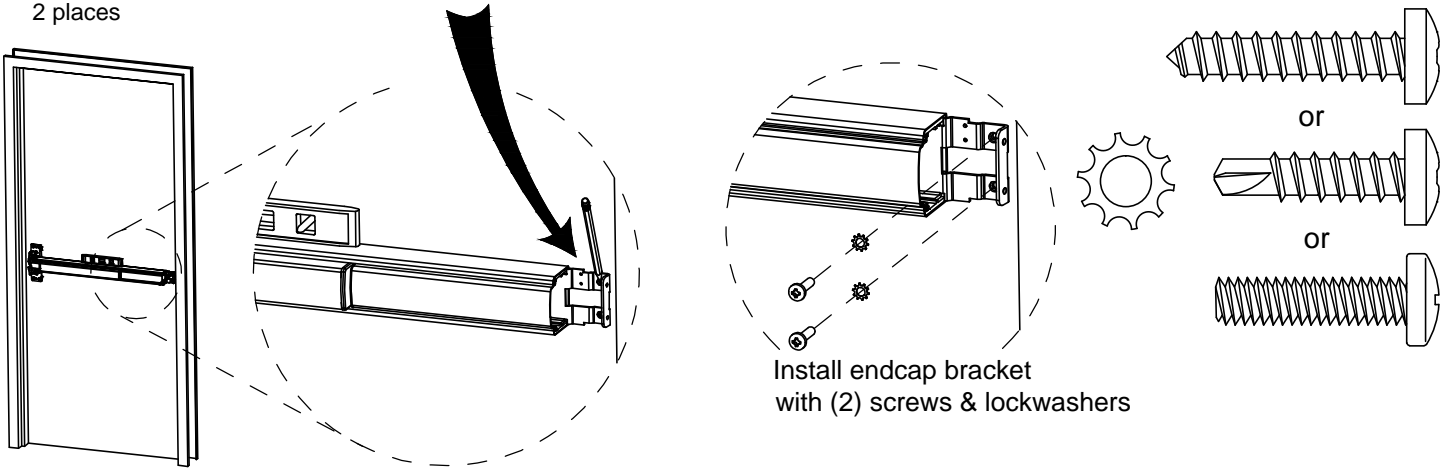

8 Install endcap and cover

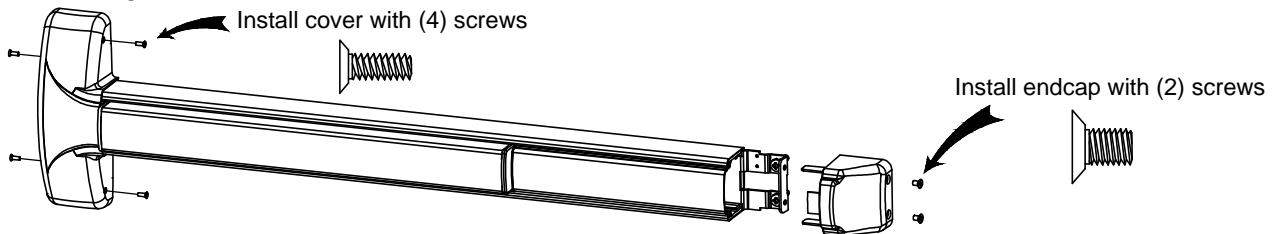

TROUBLESHOOTING

Adjust centercase fingers, if latchbolt will not retract fully

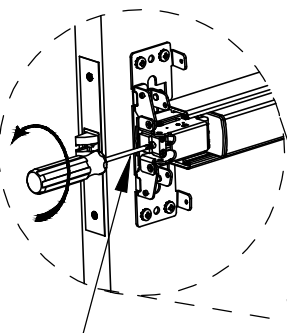

See Detail G

Loosen (2) screws & turn center screw CCW for latchbolt adjustment

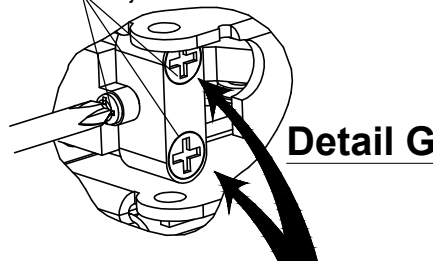

Detail G

Tighten screws after adjustment

Optional Accessories

Glass Bead Kit
Part No: 103319



#1/4-20 X 1-1/2" Screw
(4) Included

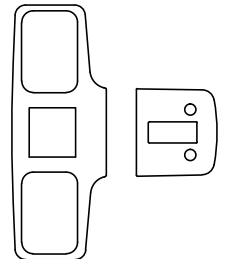

Sex Nut

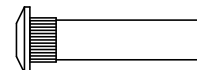

The #1/4-20 kit is available in (4) finishes:
Part No: 101616-2 Brushed Brass BHMA 606 Finish
Part No: 101616-5 Oil Rubbed Bronze BHMA 613 Finish
Part No: 101616-7 Brushed Chrome BHMA 626 Finish
Part No: 101616-9 Stainless Steel BHMA 630 Finish