

BURR KING®



MADE IN USA
SINCE 1951

- GRINDING
- POLISHING
- SURFACE CONDITIONING
- DEBURRING
- CLEANING
- DESCALING
- FINISHING



BELT GRINDERS • DISC GRINDERS • POLISHERS
VIBRATORY • SURFACE CONDITIONING EQUIPMENT

WWW.BURRKING.COM • (660)438-8998



PROVIDING QUALITY FINISHING PRODUCTS SINCE 1951

Broad Product Line

For over sixty years Burr King grinders, polishers, and vibratory products have been used by the world's leading companies. Our products use innovative designs of uncompromising quality, they are industrial grade, intended for use on metals, wood, composites, plastics, rubber, stone, fiberglass, and other materials. Burr King products are simple-to-use, no nonsense tools preferred by professionals.

Quality first and last

Each Burr King machine, accessory, and consumable is rigorously tested for specification compliance throughout its manufacture. Should we deliver a product that does not function, or meet its intended purpose we will correct the situation without quibbling - guaranteed!

Free tests and evaluations on customer parts

Parts may be sent to the Burr King factory for a full process test report. Customers will receive their processed parts back with a complete, easy to understand finishing recommendation that lists methods, materials, equipment, and time variables. Burr King customers can make informed, low risk buying decisions.

Customer site product trial

Many Burr King products can be brought directly to the customer's plant for demonstration. Where this is not practical any Burr King machine can be delivered to the customer's work site for actual customer trial prior to purchase. Call the Burr King factory for information about this valuable program.

Ready and competent customer service

Our factory personnel, and national product representatives are ready and able to assist customers with applications, service, repair, and/or special situations.



Made in the USA

Click or Scan the QR Codes for more information



What others are saying

BURR KING MANUFACTURING CO., INC.

1220 TAMARA LANE, WARSAW, MO 65355
(660) 438-8998, FAX (660) 438-8991

INFO@BURRKING.COM, WWW.BURRKING.COM



“Velvet Touch” Three Wheel Belt Grinders

Burr King’s family of three wheel grinders provides maximum versatility. Contact wheel, platen, workrest support, and loose belt grinding are precision controlled with positive belt tracking, quick belt change, and linear belt tension. Constructed of rugged cast aluminum and precision machined components, every Burr King grinder delivers unexcelled grinding performance and reliability.

MODEL 760

CAUTION

USE PROPER EYE, FACE, HAND AND BODY PROTECTION WHEN USING THIS OR ANY OTHER GRINDER.



e-catalog



Shown with optional variable speed

72110 shown



- Versatile
- Reliable
- Powerful
- Smooth
- Aggressive
- Heavy Duty

- Rotating parts covered eliminating parts entanglement, greater operator safety
- Deeper horizontal and vertical throat clearance for larger and odd shaped parts
- Improved dust extraction
- New and improved door latching system
- New pinch point guarding when back up platen is removed
- Urethane covered idler wheels for longer life
- New idler wheels are electrostatically conductive

MODEL 760 IS THE LARGEST EXAMPLE OF OUR VERSATILE THREE WHEEL BELT GRINDERS. IT OFFERS CONTACT, BACKUP PLATEN, WORKTABLE AND LOOSE BELT GRINDING AT 8000 S.F.P.M.

“Velvet Touch” Three Wheel Belt Grinders

MODEL 482



e-catalog

STANDARD
48" BELT
UP TO 2" WIDE



40100 shown



- Contact wheel, platen and workrest support grinding
- Slack belt grinding
- Adjustable belt tension
- Positive belt tracking/patented design
- Quick belt change
- Large throat clearance for enhanced work point access
- Variable speed 120/220-1 PH, and 220/440-3 PH options
- Precision machined cast aluminum frame
- Accepts internal grinding attachments (excluding model 562)
- Accepts nylon, buffing, wire, fiber wheels
- Compact footprint friendly to "cell" manufacturing
- OSHA compliant, enclosed guarding

MACHINE CAN BE PEDESTAL OR BENCH MOUNTED.

MODEL 562

STANDARD
42" BELT
UP TO 1" WIDE

Model 562 shown with optional dust scoop, (DS-5) & pedestal.



e-catalog



56100 shown



Model 482 - 41110 shown with optional 01 pedestal, DS4 dust scoop and 760T-2 Tool Tray



“Velvet Touch” Two Wheel Belt Grinders

MODEL 960-250

STANDARD
60" BELT
UP TO
2 1/2" WIDE



e-catalog



90100 shown

VERTICAL/HORIZONTAL

Burr King’s family of two wheel grinders provides vigorous contact wheel, workrest, and platen grinding in a frame design that pivots to ideal work positions. These machines are frequently selected as tool post grinders, roll grinders, and for fixturing into centerless grinding applications. Available in easily adjusted variable speed and aggressive single speed, 2-1/2" x 60" or 4" x 60" belt models.

- Contact wheel, platen and work support grinding
- Adjustable belt tension
- Positive belt tracking
- Quick belt change
- Up to 8000 SFPM belt speed standard
- Compact footprint friendly to “cell” manufacturing
- Adapts for “tool post” or “on center” grinding
- Adapts for robot mounts
- Variable speed 120/220-1 PH, and 220/440-3 PH options
- Precision machined cast aluminum frame
- OSHA compliant, enclosed guarding

MODEL 960-400

STANDARD 60" BELT
UP TO 4" WIDE

**SURFACE GRINDER
ATTACHMENT NOW AVAILABLE**

*Shown with optional
variable speed*

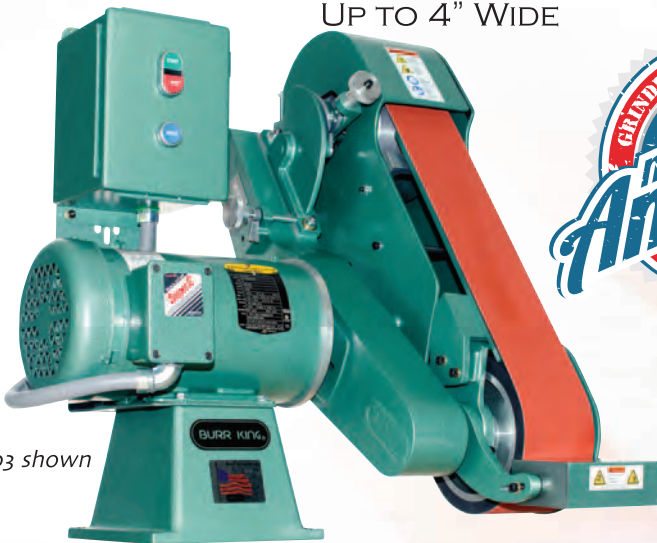

95103 shown

Shown with optional mag starter.



e-catalog



97110 shown

Easily adjusted vertical or horizontal.

BURR KING

Two Wheel Belt Grinder **X400**



e-catalog



24820 shown

A Professional Grinder at a Consumer Price!

- Contact wheel, platen and work support grinding
- 2" x 48" Belt
- Powerful 1 HP motor
- Adjustable belt head
- Positive belt tracking
- Quick belt change
- Up to 8000 SFPM belt speed standard
- Compact footprint friendly to "cell" manufacturing
- Fixed and Variable Speed options available
- Precision machined cast aluminum frame
- OSHA compliant, enclosed guarding

**MACHINE CAN BE PEDESTAL
OR BENCH MOUNTED.**

BURR KING 'E' MACHINES *ENHANCED GRINDERS AND POLISHERS*



PDF Flyer



7211007 shown

All the Features of our Regular Belt Grinder & More

- Variable Speed
- Running Indicator Light
- 30mm Mushroom Stop Button
- Positive Door Guard Switch
- Rapid-Stop Braking Technology
- GFCI Compatible VFD
- Special Drive Firmware



The 760E with Rapid-Stop Braking™ will activate the brake and stop the machine in just seconds when either the red mushroom stop is activated or the door is opened. With the addition of the switch, wired directly to the controller, it prevents operators from leaving the door in an open position while running. The door must be closed to activate the belt grinder.

DISC GRINDERS & POLISHING LATHES CAN ALSO BE ENHANCED

Many of our other machines we manufacture can also be outfitted with these enhanced features. Please contact your manufacturing representative or the Burr King factory for more information.

NOTICE: It should not be implied that the 760E is a safer machine to operate or to own than the standard belt grinders. The "Enhanced" incorporates features that Burr King customers have suggested us adding. It must be understood improper uses of any equipment may be dangerous. Please read and understand all operating instructions.

ALWAYS WEAR PROTECTIVE EYE, FACE, ARM, LEG AND BODY GEAR WHEN USING ANY GRINDER, POLISHER, BUFFER OR OTHER ROTATING MACHINERY.



THE KNIFEMAKER'S EDGE! MODEL 960-272

- 8" or 10" Diameter Contact Wheel Available
- Grind, polish, buff with one machine.
- Hollow grind, flat grind, contour, slack belt, vertical or horizontal platens.
- Fixed and variable speeds, smooth running.
- Small wheel attachment.
- Serrated contact wheels for rapid stock removal.



e-catalog



99730 shown
Shown with
variable speed

**SURFACE GRINDER
ATTACHMENT NOW AVAILABLE.**



PDF Flyer



Optional 944
Vertical Platen
Attachment



Optional 965 Small Wheel
Attachment for 2" wide belts.
5/16" - 1.5" Wheels
Inboard and Outboard
Bearings Style Attachments
Are Available

CAUTION: The Model 960-272 belt grinder is designed to be used by persons who require full access to most portions of the belt path. As such users of the 960-272 must exercise caution when using the machine to avoid entanglement in rotating parts, entrapment in pinch points, being struck by grinding debris, being struck by ejected work pieces and other hazards that are associated with power driven rotating equipment. Failure to properly use the machine, follow operating instructions, and good safety practices may lead to serious personal injury, death or property damage. Not for industrial applications. If you require a machine designed for industrial applications please see the Model 960 on page 5.



e-catalog



MODEL 720 PROBE BELT GRINDER

**Manual
Spring
Tension**

16110M Shown

**Air
Tension**

16110A Shown

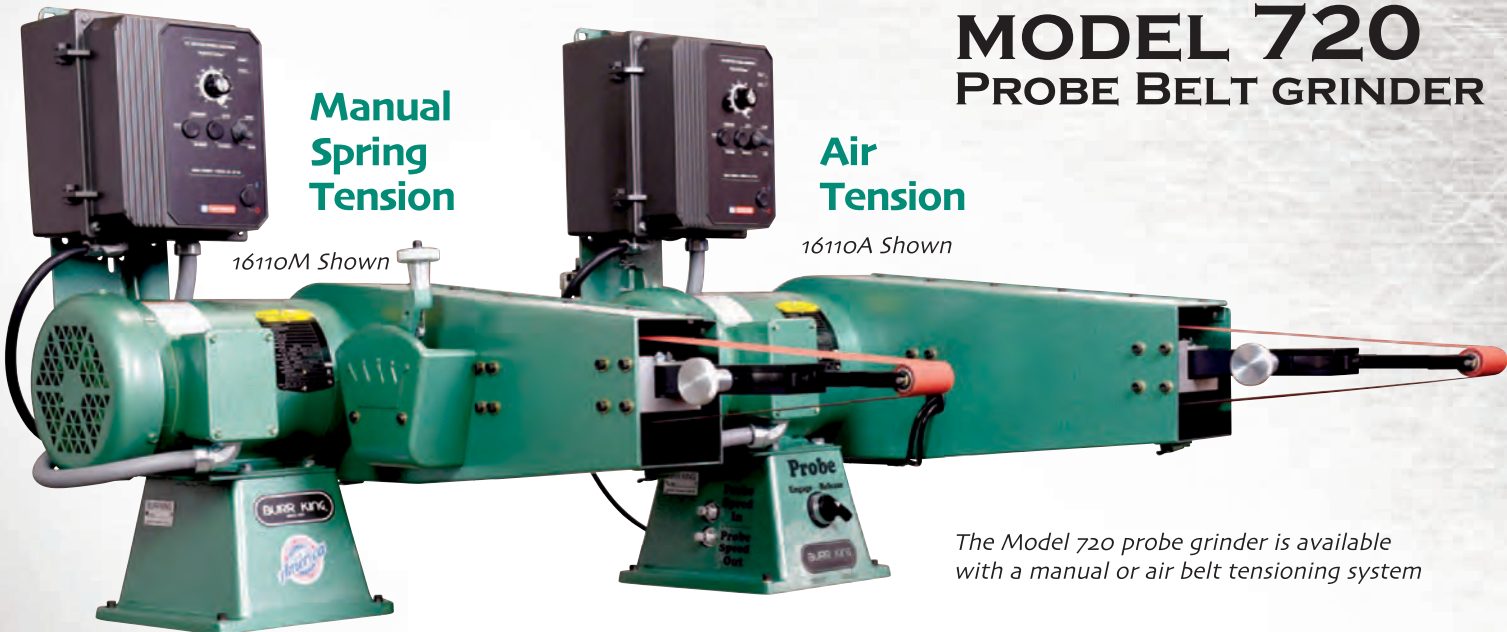

The Model 720 probe grinder is available with a manual or air belt tensioning system

MODEL 720 PROBE BELT GRINDER DELIVERS MORE UTILITY TO BURR KING CUSTOMERS!

- Reach into deep cavities
- Finish the I.D. of tubing
- Work exotic materials with multiple belt speeds from 500 to 5500 SFPM
- Excellent for turbine blades
- Delicately blend finishes
- Rough away material
- Finish inside diameters



The Model 720 presents a unique up front, two wheel, rear drive configuration that quickly accepts contact wheel finishing diameters from 3/8 inches to 3 inches in diameter. The Model 720 is equipped with a reliable and fully adjustable air pressure or manual spring belt tension control system. Using 1/2 inch to 2 inch belt width. The Model 720 72 inch belt track delivers long abrasive life coupled with excellent utility. Available in single or Variable speed. See page 14 for accessory arms.

Wide variety of front wheel options are available for the 720. Outboard bearings for longer life to close access for tight areas.



STANDARD FEATURES:

- 72 inch belt track
- 1/2 to 2 inch belt widths (Optional)
- 1 inch diameter x 2 inch wide contact wheel (Standard)
- Standard wheels 3/8 inch to 3 inch
- Up to 5500 SFPM
- 1.5 hp in popular voltage and phase options
- Air Tension control abrasive belt
- Pressure regulation and adjustment
- Accepts all Burr King 1400 series nose attachments (choice of one with machine)
- Heavy fabricated steel frame
- Out front grinding point with up to 14 inches probe capability (diameter dependent)
- Integrated dust collection shroud with 3 inch outlet
- Belt guard with belt access door
- Bench or pedestal mount
- Foot print approximately 20W x 36D x 36H

OPTIONAL FEATURES:

- Variable speed from 500 to 5500 SFPM in 1 phase and 3 phase options
- Magnetic starters
- 2 horse power motors
- Mounting pedestal
- Various nose attachments with contact wheels from 3/8 to 3 inches in diameter with 1/2, 1, and 2 inch widths
(See Factory for larger wheels and sizes)

ALWAYS WEAR PROTECTIVE EYE, FACE, ARM, LEG AND BODY GEAR WHEN USING ANY GRINDER, POLISHER, BUFFER OR OTHER ROTATING MACHINERY.



e-catalog

MODEL 979 3" x 79" BELT GRINDER

This aggressive belt grinder features a 3 x 79 inch belt track with heavy steel construction to deliver material finishing with the quiet, smoothness that customers expect from a quality grinding machine year after year.

- 3" x 79" belt track
- 7200 surface feet per minute (SFPM) belt speed
- 3 or 5 horsepower American made motors
UL/CSA variable speed option available
- Swing frame grinding option
- Heavy welded steel construction
- 8" diameter 70 durometer serrated contact wheel with deep groove sealed ball bearings
- Integrated, heavy steel pedestal with optional elevation control
- Ventilated 3-1/2" x 18" steel platen
- 3" Hose Outlet



Shown with optional mag starter. Pedestal included.



17313 shown

Optional Magnetic starter and elevation control.



Model 979 adapts as a swing grinder.

SAFE

- O.S.H.A. compliant belt track and pinch points guarding
- UL/CSA motors and electrical controls

OPERATOR & SHOP FRIENDLY

- Quick easy belt change with positive simple belt tracking control
- Quiet smooth running minimizes operator fatigue
- Small footprint uses less shop space

BURR KING®

WET GRINDERS

2.5" OR 4" WIDE



31100 shown

IDEAL FOR LAPIDARY, GLASS, AND OTHER FINISHING APPLICATIONS OPTIMIZED BY DIAMOND ABRASIVES! WITH DIAMOND BELTS YOU WILL EXPERIENCE UP TO 100 TIMES THE LIFE OF EXPECTANCY OF SILICON CARBIDE ABRASIVES WHILE ATTAINING VASTLY SUPERIOR RESULTS!

- 5000 surface feet per minute to optimize modern diamond abrasives
- 960-401 features 4 x 60 inch belt track
- 960-251 features 2-1/2 x 60 inch belt track
- Integrated water fed system including pump, water flow adjusting valve, dual 120 degree spray nozzles, stainless steel water receiver tray with drain, sump, and interconnecting flexible tubes
- 1HP NEMA 4x motor and switch for wet application
- Ground fault interrupter power distribution "rain" box with master switch for the grinder and feeder pump for maximum safety in wet grinding modes
- Cast aluminum frame for Burr King ruggedness
- Safe belt track guarding that is OSHA compliant
- Bearings are high quality and sealed for life
- Belt change is quick with a linear belt tension device
- Belt tracking is simple and effective
- Work position is adjustable from horizontal to vertical
- Platen is full belt and generously long
- Contact wheel, slack, or platen grinding
- Dry grinding is as simple as turning off the pump
- GFCI compatible variable speed control
- One year, limited warranty
- Made in the USA

Shown with optional variable speed.
(Pedestal included)

SumpPak 1000 filtration system and pedestal are included (Shown).

960-251



e-catalog

960-401



e-catalog





STANDARD BELT GRINDER SPECIFICATIONS



For optional features & specifications consult factory.

	Model 760	Model 960	Model 482	Model 562	Model 979	Model 720	Model 960	Model X400
Abrasive Belt Size	1-1/2" or 2" x 60"	2-1/2" or 4" x 60"	2" x 48"	1" x 42"	3" x 79"	1" to 2" x 72"	2-1/2" or 4" x 60"	2" x 48"
Abrasive Belt Speed (upto)	8000 SFPM	8000 or 6500 SFPM	6000 SFPM	5300 SFPM	7200 SFPM	5500 SFPM	5000 SFPM	8000 SFPM
Throat Clearance	8-7/8"	None	7-1/2"	5-1/2"	None	None	None	4"
Contact Wheel Dimensions	7" x 1-1/2" or 7" x 2"	7" x 2-1/2" or 7" x 4"	5" x 2"	4-3/4" x 1"	8" x 3"	1/2" x 1" - 2" x 3"	7" x 2-1/2" or 7" x 4"	7" x 2"
Contact Wheel Hardness (Optional 90 Duro)	55 Durometer	55 Durometer	55 Durometer	55 Durometer	70 Durometer	70 Durometer	55 Durometer	55 Durometer
Belt Tension, Quick Change Assembly	Yes	Yes	Yes	Yes	Yes	Yes	Yes	Yes
Positive Belt Tracking Adjustment	Yes	Yes	Yes	Yes	Yes	Yes	Yes	Yes
Overall Height x Width x Depth	26" x 24" x 23"	30" x 21" x 30"	21" x 20" x 19"	20" x 17" x 15"	48" x 26" x 44"	36" x 20" x 36"	16" x 22" x 30"	28" x 20" x 18"
Safety Belt Guard	Yes	Yes	Yes	Yes	Yes	Yes	Yes	Yes
Base Area	10" x 13"	8-1/2" x 8"	10" x 13"	10" x 13"	18" x 18"	8-1/2" x 8"	8 1/2" x 8"	10" x 13"
Steel Backup Platen	2" x 6" x 1/4"	2-1/2" x 8" 4" x 14"	2" x 6" x 1/4"	1" x 5" x 1/8"	3-1/2" x 18"	None	2-1/2" x 8" 4" x 13"	2" x 6" x 1/4"
Adjustable Workrest	Yes	Yes	Yes	Yes	Yes	None	Yes	Yes
Construction	Cast Aluminum	Cast Aluminum	Cast Aluminum	Cast Aluminum	Fabricated Steel	Fabricated Steel	Cast Aluminum	Cast Aluminum
Estimated Shipping Weight	105 - 135 lbs	95 - 145 lbs	80 - 105 lbs	75 - 100 lbs	375 lbs	180 - 200 lbs	180 - 240 lbs	90 lbs
Bench or Pedestal Mounted	Yes	Yes	Yes	Yes	Stand	Yes	Yes	Yes

ALWAYS WEAR PROTECTIVE EYE, FACE, ARM, LEG AND BODY GEAR WHEN USING ANY GRINDER, POLISHER, BUFFER OR OTHER ROTATING MACHINERY.



Value Adding Accessories & Options

1400 SERIES

Internal Grinding Attachments
Convert Model 760 Grinders
for Internal Grinding.

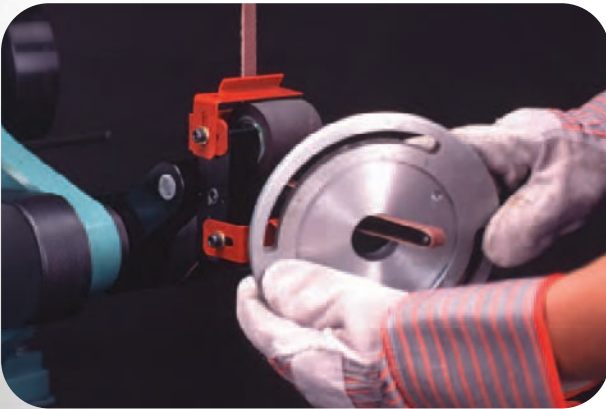

- Small radius grinding
- Cavity grinding
- Hole grinding
- Quick installation, quick removal
- Increases standard belt length by 12"



BELT WIDTHS
1/2" TO 2"

Radius and Internal Grinding

A variety of interchangeable wheel sizes are available to allow tight radius and internal grinding.

INTERNAL & RADIUS ATTACHMENT



<u>Description/ Stk Code</u>	<u>Belt Width</u>	<u>Wheel DIA." Options</u>	<u>Std. Whl. DxW</u>
Fork Style/ 1400	1/2"	7/16, 5/8	7/16 x 3/8
Fork Style/ 1401	1"	9/16, 3/4, 1, 1 1/2	1 x 1
UNI Style/ 1401U	1"	9/16, 3/4, 1, 1 1/2	1 x 1
Close Access/ 1411	1"	9/16, 3/4, 1, 1 1/2	1 x 1
Fork Style/ 1402	2"	9/16, 3/4, 1, 1 1/2	1 x 2
Outboard Fork/ 1403	2"	1/4" - 2"	1 x 2
Close Access/ 1412	2"	9/16, 3/4, 1, 1 1/2	1 x 2

Fits all Model 760 regardless of age.

ACCESSORY ARMS

Value Adding Accessories & Options



Contact Arm #1453
2"x1" Contact Wheel



Contact Arm #1443
1"x2" Contact Wheel

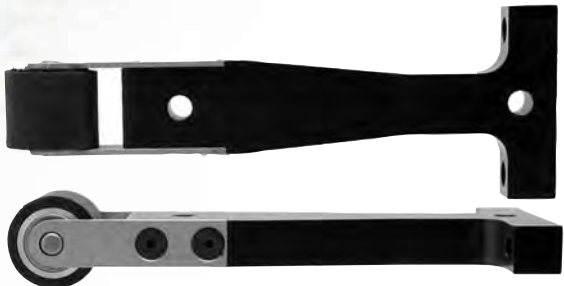

Contact Arm #1470
1"x.830" Contact Wheel

Wheel Diameters
from 3/8" to 3"

Wheel Widths
from 1/2" to 2"



Contact Arm #1451
1"x1" Contact Wheel

Wheel Hardness
from 50 to 90
Duro

Wheels Plain
Faced/Serrated

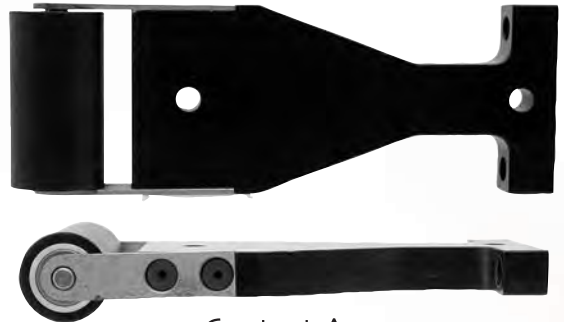

Contact Arm #1490
1"x 1.830" Contact Wheel

Call Us For
Additional
Specifications
and Options



Contact Arm #1452
3"x1" Contact Wheel



Contact Arm #1423
3/8" x 7/16" Contact Wheel



Internal
Grinding
Arms
e-catalog

**INTERCHANGEABLE
ARMS FIT ALL
INTERNAL GRINDING
ATTACHMENTS &
M720 PROBE GRINDER**



Value Adding Accessories & Options

PEDESTAL STANDS



Adjustable pedestal.
Easily change the
pedestal height from
28" up to 38"



e-catalog



Burr King heavy duty pedestals are designed to position grinding and polishing machines at a convenient operator height of 32". They must be securely bolted to the floor.

VARI-SPEED MOTORS/ CONTROLLERS



The variable speed motor option is available on all Burr King models. Surface speeds from 800 to 8000 S.F.P.M. are obtainable.

The variable speed motor controls temperature, cutting action, and finish to achieve desired results.

The adjustable speed motor controller supplies constant torque, has solid state controls, on/off switch, power light indicator with dial speed control.



MAGNETIC STARTERS

Magnetic starters provide low voltage and lost phase protection. They are recommended for all three phase machines. Magnetic starters protect motors from harmful currents, overloads, and excessive temperature rise. Machines may be ordered with a magnetic starter factory installed. Factory installed starters are securely bracket mounted or provided with an umbilical suitable for mounting the starter on a wall or post. Consult with the factory for the proper starter/motor and installation combination.

NOTE: Factory warranty may be voided if magnetic starter is not used with 3 phase models.





Standard Features

CONTACT WHEEL GRINDING



Contact wheel grinding is the most aggressive type of grinding and should be used when heavy stock removal is required. Each elastomer tired aluminum contact wheel is precision machined and balanced for smooth operation. It has been said, when compared to a bench grinder, "that grinding on a Burr King is like grinding on velvet."

The contact surface is bonded neoprene, available in 55 and 90 durometer with a plain or serrated face. Special narrow contact wheels are available.

Serrated contact wheels cut faster, run cooler, and give longer abrasive belt life. 2-hp to 3-hp motors are recommended when using these wheels for heavy stock removal.

BACKUP PLATEN AND WORKREST



The backup platen provides a large surface area for flat grinding and may be removed when not in use.

When backup platen is removed, contact wheel guard should be moved forward to guard pinch point.

The workrest is fully adjustable to any angle on the backup platen or contact wheel. It may be positioned below the contact wheel when not in use.

2-hp and 3-hp motors are recommended for use of backup platen for heavy stock removal.

CONTOUR AND LOOSE BELT GRINDING

The large throat clearance of the Burr King three wheel belt grinders provide large working area for contour and loose belt grinding, polishing, and deburring. Slack grinding and contact wheel grinding may be performed simultaneously with no special set-ups or down time.





Standard Features



70100 Shown

QUICK BELT CHANGE

The rear wheel quick change assembly makes belt changing a quick and simple operation. Lift handle and depress the button located in the center of the quick change knob, pull the handle forward to release tension, remove and replace the abrasive belt. The ratchet design of the quick change provides a positive and variable belt tension for loose belt and contour work.

BELT TRACKING ADJUSTMENT



70100 shown

SAFETY GUARDING

Burr King industrial grinders/buffers are fully guarded to protect pinch-points and unused portions of belt track areas. Guards permit easy access for rapid change of belts/discs and buffing wheels.

Models 760 and 960 are shown



Model 760 (70100) shown with optional DS7 dust scoop

Model 960-400 (95103) shown with optional DS94-2 dust scoop

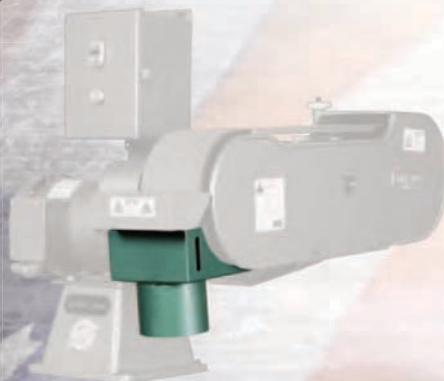

Positive tracking of the belt on the contact wheel is achieved by rotating the tracking knob to track belt left or right on the contact wheel while the machine is running. This patented device is easily accessible to the operator.



Value Adding Accessories & Options



NARROW BELT GRINDING

The optional 702N "Narrow Wheel" uses a 1/2" x 60" abrasive belt, for tight radius and loose belt grinding.

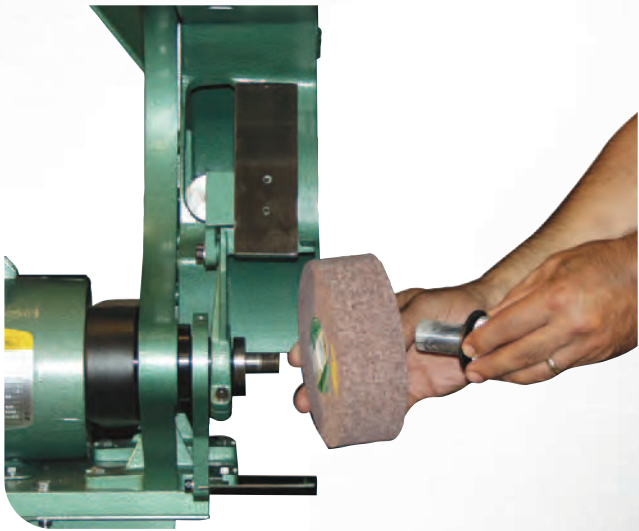

NYLON WHEELS AND ADAPTERS

Wheel adapters are available in popular widths to economically convert your grinder to a nylon finishing machine capable of graining, polishing and deburring for special applications.



GRINDERS AND BUFFERS

Readily accepts flap, nylon, buffing, wire, and pneumatic wheels using inexpensive adapters.



WHEEL ADAPTERS

Accessories expand Burr King grinders and polishers.

Value Adding Accessories & Options



e-catalog

CONTACT WHEELS



Grinders/buffers capability is readily expanded by selection of the best contact wheel/buffing wheel combination for your material. Many contact wheel diameters, widths, hardnesses and face geometrys are available - 55 shore, for general purpose grinding, 90 shore serrated for heavy grinding. Numerous nylon wheels, buffing wheels and specialty wheels are available. Consult with the factory for proper selection.

ABRASIVE BELTS/DISCS



Abrasive belts and discs in various dimensions, grit types, and backing are available. Finishes from mirror to grain are possible. Material removal rates from slight to rapid and heavy are possible provided the proper abrasive, backing, surface speed, and equipment are selected. Consult with the factory for specific applications.

DUST COLLECTION SYSTEMS

BK 125 >



< BK 75



BK 100 >

Burr King dust collectors use space saving cabinet design. All Burr King grinders/buffers may be coupled to these efficient dust collection systems. Select the BK 75 or BK 125 for portability or the BK100 for two grinder/buffer, fixed installation. Includes silencer and spark boxes. Machine sold separately.

DUST SCOOPS

Dust scoops are available for all Burr King models.



MODEL 600

Deburring & Polishing Machines



60100 shown
Wheel not included



e-catalog

The Model 600 and 800 machines provide fast and effective graining, finishing, deburring and surface conditioning. Designed to run nylon, flap, wire, and buffing wheels. Variable speed options extend the range and capability of the Model 600 and 800 machines. Composite, vitreous, and stone wheels are prohibited on the Model 600, and Model 800 and Burr King grinders.

ACCESSORY WHEEL ADAPTERS



WA12

For wheels with 1/2" bore



WA14

Fits wheels up to 2" wide with 1-1/4" bore



WA1

Fits wheels 1" wide with 1" bore



WA2

Fits wheels 2" wide with 1" bore



Wheel Adapters



e-catalog

MODEL 800



8110 shown



e-catalog

Model 800 shown equipped with optional variable speed. This option enables you to achieve many different types of finishes from graining to a high polish affect with one machine. Also available with optional dust scoop. (Wheel not included)

- Popular 6x1, 6x2, 8x1, 8x2 inch wheel options
- Quick wheel change
- Uses nylon, cotton, wire, fiber wheels
- Balanced, quiet, velvet smooth operation
- Up-front point of work
- Up to 4140 RPM spindle speed standard
- V-belt drive for efficient power transfer
- Pedestal or bench mount
- Compact footprint friendly to "cell" manufacturing
- Popular horse power options in popular voltages
- 50 hertz/motor/control options
- Variable speed 120/220-1 PH, and 220/440-3 HP options
- Sealed, long life bearings
- Rugged cast aluminum frame
- Precision machined and fabricated
- Full hood for dust collection
- OSHA compliant guarding
- UL/CSA listed electrical devices
- Burr King performance
- Burr King dependable!

NOTE: CONSULT WITH FACTORY FOR SPECIAL APPLICATIONS AND ADAPTERS

The Models 1000 and 1200 de-burrs, grains, polishes, cleans, de-scales, and buffs at a single station, a single machine, and a single operator.

MODEL 1000



e-catalog



14120 shown

Model 1000 takes 10" wheels. (Not included)

Shown with optional variable speed.

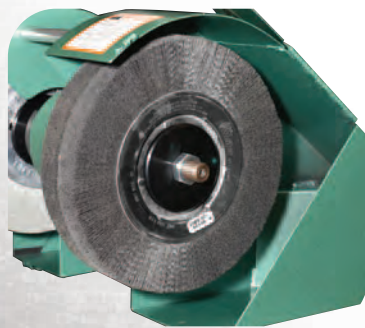

- Convenient "up-front" wheel design takes the "difficult" out of "difficult to do parts"
- Convenient spindle position for speedy, comfortable operator transfer of parts wheel to wheel
- Versatility of convolute, flap, wire, fiber, nylon, or bristle-brush wheels
- Versatility enhanced by narrow and wide wheel capability mix and match wheel sizes and types
- Rugged, oversize, hardened and ground spindle with counter threaded 3/4" diameter wheel arbors
- Versatility of variable speed control options
- Work reducing horse power options
- Smooth "velvet touch" operation delivered by the precision you expect from Burr King
- Smooth, quiet "Micro-V" drive technology is operator friendly
- Durability of a cast aluminum frame

MODEL 1200

Uses 12" wheels. (Not included)

(Pedestal included)

19610 shown

Shown with optional variable speed.



e-catalog

- Reliability of oversize "deep groove" ball bearings, fully shrouded and sealed for extended life
- Flexibility of bench or pedestal mounts
- Safety maximized by wheel guards with latching access doors
- Cleanliness maximized by an integrated dust shroud with dust outlet
- Expandable by the addition of magnetic starters
- Space saving compact size friendly to "cell manufacturing"
- Economy of minimal maintenance
- Full one year limited warranty





e-catalog



11011 shown

Shown with optional variable speed and optional dust scoops.
(Wheels not included)

BUFF AND POLISH WITH THE SAME MACHINE



11011 shown

Shown with optional variable speed.
(Wheels not included)

MODEL 1001 VARIABLE SPEED POLISHING LATHE

After numerous requests, Burr King has answered the call once again with the M1001 Variable Speed Wide Polishing Lathe. The M1001 was based off of Burr King's top selling M1000 which features many of the same features found on the popular M1000.

Both machines will handle the most demanding polishing applications or for that extremely fine detailed work where only a variable speed Burr King will work.

By using an indirect drive system motor vibration is isolated to the motor, also vibration created by buffing wheels will be isolated from the motor resulting in longer bearing and motor life.

- Convenient "up-front" wheel design takes the "difficult" out of "difficult to do parts"
- Plenty of room between wheels almost 2 feet!
- 250-2500 RPM Variable Speed
- Versatility of convolute, flap, wire, fiber, nylon, or bristle-brush wheels
- Versatility enhanced by narrow and wide wheel capability mix and match wheel sizes and types
- Rugged, oversize threaded 3/4" diameter wheel arbors
- Versatility of variable speed control options
- Work reducing horse power options
- Smooth "velvet touch" operation delivered by the precision you expect from Burr King
- Smooth, quiet "Micro-V" drive technology is operator friendly
- Durability of a cast aluminum frame

The Burr King M1001 is designed for use with soft cloth or surface conditioning wheels (ScotchBrite®) only. Specific polishing applications may require additional installation of safety devices. Please consult with a safety engineer before use. Machine includes flanges and nuts, all wheels sold separately.

MODEL 1051 TUBE FINISHER



e-catalog

M1051 shown



The M1051 offers deburring and finishing of pipe, extrusions and flat material



The M1051 has an intergraded 4" dust scoop

M1051 Tube Finisher is available in multiple voltage and horsepower configurations. The M1051 can also be equipped with variable speed and RapidStop Braking™

The Model 1051 joins Burr King's full line of polishing lathes that are fully capable for deburring and polishing.

The Model 1051 was designed from the ground up to run wire brushes up to 10" in diameter and up to 3" wide. Deburr and finish round pipe, square tube, profile extrusions and flat pieces with ease.

- Deburr & finish pipe, profile and flat Pieces
- 10" diameter up to 3" wide
- Reversible/adjustable steel workrest
- 4" discharge dust outlet
- Available up to 5 HP 3 phase
- Fixed and variable speed models available
- Cast & billet aluminum construction
- Multiple wheel options
- Bench or pedestal mounted
- Cell manufacturing friendly
- 2" of wheel adjustment
- Maintenance free adjustment mechanism
- Adjustable polycarbonate scatter shield
- American designed and manufactured in Warsaw, Missouri



Easily mount a wide variety of wheels up to 3" wide. The side door is a hingeless design with only a single clip for access to the wheel.

BURR KING

MODEL 20 20" DISC GRINDER

The Burr King Model 20 disc grinder is the last all Made in the USA 20" Disc Grinder on the market. Roughed cast and a solid billet aluminum disc makes the best disc grinder on the market!

The Model 20 is:

- Precise enough for patternmakers
- The ideal tool to shape, flat grind, contour metal, wood and plastic
- Rapidly grinds and deburrs castings or fabricated parts
- Up to 9000 SFPM disc speed
- Reversible disc rotation
- Cast iron 3 horse power motor
- Rugged gray iron, ductile iron, and aluminum castings
- Miter gauge slide receiver
- Elevating Tilting Work Table
- Heavy Cast Iron/Aluminum Construction
- Premium Gears/Bearings Bushing
- Precision Machined/Balanced Solid Billet Disc
- Gear Driven Table Lift/Tilt
- Tilting Safety Guard
- Dust Scoop (DS20) (Optional)
- Miter Attachment (MA1) (Optional)

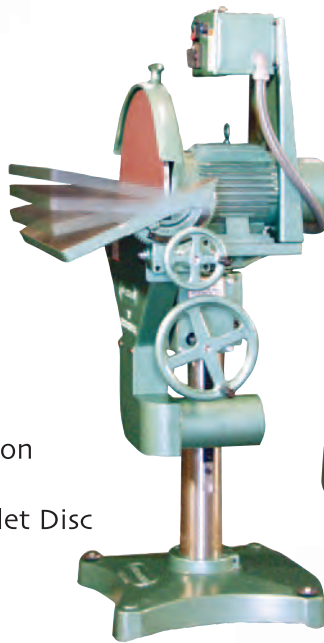

optional dust scoop



24103 shown

Disc is guaranteed to have face run out at less than 0.005 T.I.R.



RUGGED, DEPENDABLE, CAPABLE, LONG LASTING



29140 shown

MODEL 12 12" DISC GRINDER

Features:

- Rigid cast aluminum construction
- Cast iron table
- Precision billet aluminum disc
- Bench or pedestal mounted
- Forward/reversing switch
- Easy disc change with unique swing away feature

Options available:

- Variable speed, 3 phase motors & controls



e-catalog

ALWAYS WEAR PROTECTIVE EYE, FACE, ARM, LEG AND BODY GEAR WHEN USING ANY GRINDER, POLISHER, BUFFER OR OTHER ROTATING MACHINERY.



VibraKING Vibratory Chambers

VIBRATORY CHAMBERS THAT DELIVER QUIET, HIGH PERFORMANCE DEBURRING, POLISHING, DESCALING AND SURFACE CONDITIONING!

Optional process timers may be added to the M25, M45, and M85. These timers permit precise process timing control to manage critical finishes and economize valuable shop time. Process timers include high quality magnetic starter contactors.



45110 shown

Shown with FilterPAK 4001 and 3387 sound dampening lid.

- Amplitude fully adjustable
- Bronze caged, sealed long life bearings
- Rugged welded steel construction
- Heavy 85 duro urethane liner 5/8" thick
- Integrated discharge chute
- Compact footprint friendly to "cell" manufacturing
- OSHA compliant, enclosed guarding

- Capacity 2.5, 4.5 and 8.5 cubic feet
- Ultra Quiet
- High Energy, Fast Process Results
- Patented Drive and Isolation
- Portable
- Integrated, Metered, Compound Delivery System
- Flow-through Design
- Accepts Filter PAK 4001
- Replaceable Drain
- NEMA, UL, CSA, Listed Electricals
- Integrated Process Timer and/or Magnetic Starter Option

Let Burr King Test Process Your Parts. -No Obligation -Full Report -FREE



All Vibra King Chambers accept one to four dividers.



All Vibra King Chambers accept optional Vibra Hush lids reducing sound emission 3 to 6 db.



Optional magnetic starter with integrated timer. Available in single or three phase voltages.



- Quick to change
- Minimizes drain clogging
- Easy to reach
- Extends tub life
- Economical
- Standard on all VibraKING tubs

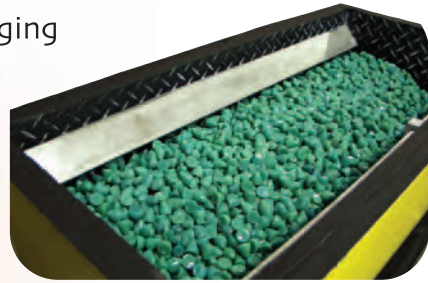

Optional deflector, prevents flat parts from sticking to machine wall.



M85
85103 shown

M45
45100 shown

M25
25100 shown

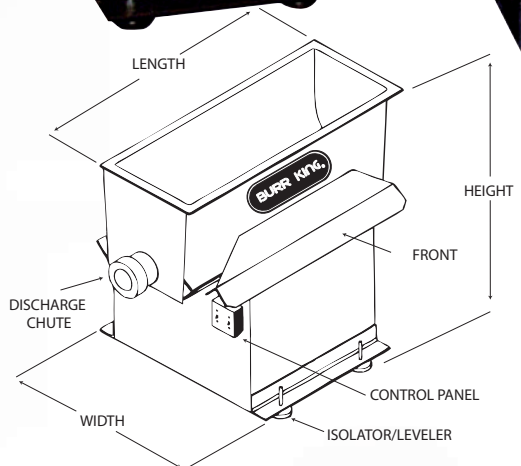

All Burr King tubs or bowls can be used wet or dry.



Vibra KING[®] with Hush Design
GENERAL DATA

	M25	M45	M85
Total volume cu. ft.	2.5	4.5	8.5
Working volume cu.ft.	2.1	3.8	7.2
Horsepower, standard	1.5 (1PH/3PH)	1.5 (1PH/3PH)	2.0 (3PH)
Overall Length max.in.	29	43	48
Overall Width max in.	33	33	36
Overall Height max in.	41	41	45
Tub depth, inside	15	15	20
Tub length, inside	20	35	37
Tub Width, inside	16	16	20
Max. part length, in.	19	34	36
Media load, lbs	150	250	450
Part load, lbs*	100	225	450
Weight max. lbs. (empty)	390	475	675

ALWAYS WEAR PROTECTIVE EYE, FACE, ARM, LEG AND BODY GEAR WHEN USING ANY GRINDER, POLISHER, BUFFER OR OTHER ROTATING MACHINERY.

BURR KING

- High Energy
- Power Cord & Switch
- Flow-Through Design
- Heavy Polymer Bowl
- Adjustable Amplitude (Except 110)

*New Design
With Discharge Chute*



110
11000 shown



150
15000-1 shown



200
20000-1 shown



200c
20000-3 shown

Burr King vibratory bowls are ideal for bench top polishing, descaling, deburring, and surface conditioning. Units are fast, quiet, and effective. Available in 3 qt, 10 qt, 20 qt, and 40 qt volumes. New 200c with discharge chute now available.

SPECIFICATION CHART 110 • 150 • 200/200c • 15

Model	Working Capacity	HP	Adjustable Amplitude	Flow thru drain	Bowl Dimensions			
					A	B	C	D
110	3 qt	1/8	No	Yes	10"	3.25"	4.25"	7.25"
150	10 qt.	1/5	YES	YES	15"	5.5"	5.75"	10.5"
200 200c	20 qt.	1/5	YES	YES	17"	6.5"	6.5"	13"
M15	40 qt.	1/2	YES	YES	21.5"	7"	8.5"	17.25"

110/150/200



e-catalog

150/200
CombiPaks



e-catalog

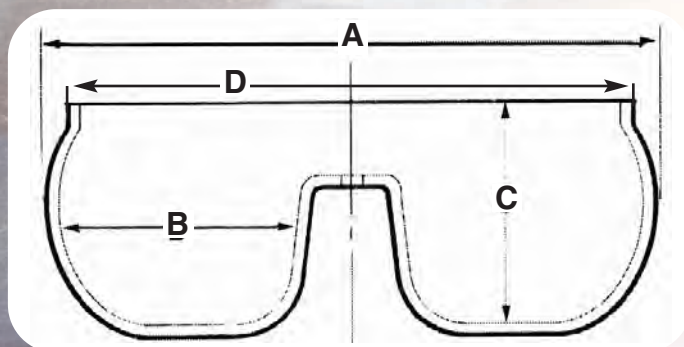

MODEL 110:
OVERALL MACHINE HEIGHT = 13"
DIAMETER = 10"
LOAD MAX POUNDS: 10

MODEL 150:
OVERALL MACHINE HEIGHT = 17 1/2"
DIAMETER = 15"
LOAD MAX POUNDS: 35

MODEL 200/200c:
OVERALL MACHINE HEIGHT = 19 1/2"
DIAMETER = 17"
LOAD MAX POUNDS: 50

MODEL 15:
OVERALL MACHINE HEIGHT = 38"
DIAMETER = 24"
LOAD MAX POUNDS: 150

ALWAYS WEAR PROTECTIVE EYE, FACE, ARM, LEG AND BODY GEAR WHEN USING ANY GRINDER, POLISHER, BUFFER OR OTHER ROTATING MACHINERY.



VIBRA KING 15

The M15 offers the same reliability and options as our smaller bowls but with more power and larger capacity. The M15 comes complete with stand and timer.

GENERAL DATA

Height max inches	38"
Width max inches	22"
Depth max inches	23"
Total volume cu. feet	1.3
Working volume cu. feet	1.0
Bowl diameter, inside inches	17.5"
Bowl depth inside	9.5"
Part length max. inches	12"
Part width max. inches	5.5"
Load max. lbs.	150
Horse power	1/2
RPM	1725
Volt/Phase	115/1



15110 shown



Media Discharge Chute >

FLEXIBLE

- Adjustable amplitude
- Ceramic, plastic, burnish, wood and shell capable for wet or dry processing
- Adapts to FilterPAK 4001 & SumpPAK 1000 filtration systems with flow through design
- Dual outlet integrates with timer to adapt accessories
- Timer Controlled, 0-6 hours

RELIABLE

- Heavy polymer bowl
- Replaceable drain
- Durable coated metal surfaces

LABOR REDUCTION

- Quick media discharge chute



M15 e-catalog



M15 CombiPaks e-catalog

CONFIDENCE/SAFETY

- UL/CSA listed motors, controls and wiring
- Fully shrouded mechanical section
- One year conditional warranty
- American designed and manufactured in Warsaw, MO
- Backed by Burr King's promise of performance and dependability

OPERATOR/SHOP FRIENDLY

- Cell Manufacturing friendly
- Portability of no bolt down operation

FASTER PROCESSING

- High energy



VIBRA KING 40 DELIVERS FAST, QUIET, HIGH PERFORMANCE DE-BURRING, POLISHING, BURNISHING, DE-SCALING, AND SURFACE CONDITIONING.



44200 shown

VIBRA KING 40

FLEXIBLE

- Ceramic, plastic, burnish, wood and shell capable for wet or dry processing
- Adapts to FilterPAK 4001 filtration system
- Adapts to common compound dosing systems
- Integrated into optional PLC remote/local control
- Standard 1" screen hole, Other sizes available: 1/2", 1-3/8", custom screens can also be made.

RELIABLE

- Replaceable drain
- Steel reinforced, heavy urethane encapsulated tub
- Durable coated metal surfaces
- Stress proof drive shaft
- Double row roller bearings with grease fittings

CONFIDENCE/SAFETY

- UL/CSA listed motors, controls and wiring
- Fully shrouded mechanical section
- One year conditional warranty
- American designed and manufactured in Warsaw, MO
- Backed by Burr King's promise of performance and dependability

OPERATOR/SHOP FRIENDLY

- Noise level below 85db (media load dependent)

FASTER PROCESSING

- High energy vibratory rate, up to 2500 pulses per second (PPS)

LABOR REDUCTION

- Variable speed controls available for quick individual part set-up
- Quick media discharge chute
- Quick separating screen changes

M40



e-catalog

M40



e-catalog

GENERAL DATA

Width max Inches	52
Front to back max. inches	36
Height max inches	42
Total volume cu. feet	4.0
Working volume cu. feet	2.2
Tub diameter, inside inches	30.25
Tub height, inside inches	11.25
Part length max. inches	16
Part width max. inches	4
Tray height minimum	34
Chute height minimum	21
Load max. pounds, combined media plus parts	350
Weight max. empty pounds	750
Floor required	concrete or other suitable
Horse Power	2.0 (1.8kw)



ALWAYS WEAR PROTECTIVE EYE, FACE, ARM, LEG AND BODY GEAR WHEN USING ANY GRINDER, POLISHER, BUFFER OR OTHER ROTATING MACHINERY.



VibraKING Vibratory Bowls & Accessories



Vibratory bowl not included.

STANDPAK 5000

The perfect mate for Burr King Vibratory Bowls

- Accepts FilterPak 4001
- 0-6 Hour Process Timer
- Timer Controlled AC outlets
- Isolator Stance
- Steel Construction Improves action
- Space Saving 16"x20"x21"
- Power Cord & Plug 110V,
- Mass finish many different material types, part shapes
- Perfect bench-top small mass finishing system
- Quiet operation
- Compatible with most media styles
- Compact footprint friendly to "cell" manufacturing

SUMPPAK 1000

The SumpPAK 1000 comes with a 5 gallon bucket, pump hanger, pump and all tubes to connect filtration system to machine. Can be used with bowls or tubs.



FILTERPAK 4001

The FilterPAK 4001 can be used with vibratory bowls or tubs. Heavy duty Polyethylene construction with single submersible pump and disposable filter bag. 10 gallon capacity. Also available FilterPAK 8000 used only with Vibra KING 85, stainless steel construction.



Mount your **VibraKING Bowl on the StandPAK 5000, add a FilterPak 4001 for a complete, timer controlled, filtered, compound finishing system.**

- Continuous fluid filtration
- Traps and holds sludge and debris in inexpensive, easily disposable filters
- Cleaner compounds results in cleaner parts
- Superior finishes and shorter cycle times with a filtered system
- Significantly reduces shop mess
- Filtration from 5 to 100 micron
- Filter change less than 2 minutes
- 115 VAC 140 GPH Pump
- 10 Gallon plus capacity
- Heavy duty Polyethylene
- Space saving 12"x14"x15"
- Dual Chamber



e-catalog



Vibratory Media & Accessories

Various media is available for processing ferrous, non-ferrous, plastics, and other materials. Finishes from sparkling clear to matte are possible with the proper selection of media and compounds. Specialty medias include ceramic, synthetic, plastics, cobs, shells, etc. Consult with the factory for the best media for your application.



Note: You can request our separate media sheet

MEDIA SELECTION GUIDE

- Size and coarseness of media may be substituted for stated media. Consult with the factory.
- Choose ceramic media for faster finishing and uniform matte finish.
- Choose plastic media for low RMS finishes and pre-plate finish.
- Larger media yields faster finishing and coarser finish. Smaller media yields slower finishing and finer finish.
- Media coarseness: P-20 most coarse; P-40 medium coarse; P-60 burnishing
- Non-abrasive, burnishing media and compounds are available. Consult with the factory.
- Other media forms, composition, and coarseness are also available. Consult with the factory.
- BKS-60 low suds soap for most non ferrous applications.
- AR-60 low suds soap with anti-rust for most ferrous applications. Provides temporary rust protection.



Magnets for retrieving small ferrous metal parts from media

Media/Parts Separating Screens and container



Test Lab

TEST LAB

The factory will test process your parts to assist in good media/compound selection for your parts. Send part samples, receive back a no cost written report recommending media/compounds/equipment.



Important Safety Information

All Burr King products are built to deliver excellent performance and reliability. Our products are designed and manufactured to meet applicable safety requirements. In order that our customers realize the maximum benefit possible from our products, our primary concern is that they understand, and use, proper and safe procedures. The following list of general safety instructions is the minimum applicable to all Burr King products. For detailed operating and safety instructions see the applicable "Operating Instructions" for the specific Burr King product.

Occupational Noise Exposure

Burr King products produce levels of noise consistent with their intended purposes. The level and spectral content of noise produced is dependent on the equipment size, the degree that the equipment is maintained in proper operating condition, the abrasive/media and accessories used, the specific application, use of options, and the surrounding environment. Noise levels produced by various Burr King models, as measured at the Burr King factory, range from 72 to 91 decibels. Product operators and persons in the immediate product vicinity should be protected from excessive noise levels as prescribed in OSHA regulation 29, part 1910.95 titled "Occupational Noise Exposure".

Product Warranty

Burr King Manufacturing Company, Inc. warrants its products to be free of defects in material and workmanship. The period of this warranty is 1 year (90 days for vibratory bowls of 20 quart and lesser volume) from the date of purchase. No warranty is provided for products that have been modified, abused, handled carelessly, where repairs have been made or attempted by others, or for freight damage. No warranty is provided for three phase electric motors, controllers, etc. when the motors, controllers are not protected by magnetic starters that were supplied and installed by Burr King Manufacturing Company, Inc. No other warranty, written or verbal is authorized by Burr King Manufacturing Company, Inc.

During the warranty period Burr King Manufacturing Company, Inc. (or its authorized suppliers or agents) will replace or repair a product without charge if the product is found by Burr King Manufacturing Company, Inc. to be defective. To receive warranty service you must contact Burr King Manufacturing Company, Inc. and receive authorization for warranty service. Unless otherwise authorized by Burr King Manufacturing Company, Inc. products must be returned to the factory to receive warranty service. Third party Burr King suppliers may provide warranty service for electric motors, pumps, and other accessories.

For the first thirty days after purchase, and when Burr King authorizes warranty service, we will pay normal and necessary freight charges both ways. After thirty days the customer is responsible for all freight charges. Where possible Burr King Manufacturing Company Inc. may elect to make on site service and/or repairs necessary to return the product to serviceable condition. Our priority at all times is to satisfy our customers.

All rotating equipment can be hazardous if not properly used and maintained. Burr King Manufacturing encourages its customers to:

1. Read and understand all operating instructions.
2. Train all operators and others in the work area in these and other safe practices.
3. Securely bolt the machine to a solid work surface.
4. Observe National Electric Codes, state and local codes for all electrical wiring and connections.
5. Keep guards and other safety apparatus functional and in-place
6. Adjust the work rest (if any) such that the gap between the moving abrasive and the work rest is less than 1/8 inch., and never acute to the belt.
7. Avoid wearing loose clothing, long hair, or other garb that may become entangled in moving machinery.
8. Use holding devices such that work pieces are not grabbed, or ejected by wheels or moving abrasive belts, disks, wheels, etc.
9. Never allow pointed work pieces to be handled or held in such a way that they could be grabbed by the moving belt, disk, or wheel and forcibly propelled toward the operator or any bystanders.
10. Use appropriate eye, face, head, arm, leg, foot protection for operators and other persons in the work area.
11. Keep the work area free of trip points and other physical hazards.
12. Use suitable inhalation protection.
13. Keep alloys separate to avoid possible combustion risks.
14. Know if the materials to be worked on can create a fire, combustion, or toxic hazard, treat them accordingly, in a safe manner, according to local codes and ordinance.
15. Use no water or other electrically conductive fluid unless your machine has been specifically designed for wet use (NEMA 4,4X)
16. Disconnect power before performing maintenance, changing abrasive devices, or otherwise entering the workings of the machine.
17. Maintain the machine in specification compliant and safe operating condition.
18. Post these and other pertinent safety instructions.



License Plate Frames



Custom Car Fabrication



Shoes



BURR KING®

CALL FOR A FREE DEMO—WE’LL COME TO YOU

Burr King’s factory trained representatives can come directly to your location and give you a hands-on demonstration. This is a great opportunity to experience the “Velvet Touch” only a Burr King can provide. Call today!



Find Your
Mfg Rep

660-438-8998

INDUSTRIES SERVED

**MOTORCYCLES • TRAINS • GOLF CLUBS • LAWN EQUIPMENT
TRACTORS • POLICE CARS • GOLF CARTS • GUNS
KNIVES • SHOES • ORTHOTICS • MUFFLERS • WELDING
FIRE DEPARTMENT • LICENSE PLATE FRAMES • HORSE
SHOES • CHOPPERS • ORGANS • DIE CAST • HOT RODS
AEROSPACE • WHEELS • BOATS • GUITARS • RACE CARS
PAINT BALL GUNS • JEWELRY • FURNITURE • BAKE WEAR
WOODWORKING • TOOL BOXES • HAND TOOLS • TRUCK
BODIES • OIL FIELD EQUIPMENT • ROBOTIC PRODUCTION
AGRICULTURE • EXERCISE EQUIPMENT • ENGRAVING
MOVIE PROPS • THEME PARKS • DENTAL EQUIPMENT
BARBECUES • MEDICAL INSTRUMENTS • HOME APPLIANCES
OFF ROAD EQUIPMENT • CONSTRUCTION EQUIPMENT
POWDER COATING • WATER ENTERTAINMENT • EDUCATION
PROSTHETICS • TACKLE • RESTAURANT EQUIPMENT
OPTICAL • COMMUNICATION HEADSETS • HIGH ALTITUDE
SUITS AND HELMETS • SNOW PLOWS • MUSEUMS • LADDERS
LIGHTING • SPORTS EQUIPMENT • SURGICAL INSTRUMENTS
SPECIALTY TRAILERS • MODEL BUILDING • SCULPTURE
MILITARY DECOYS • SHIP BUILDING • THEATRICAL EQUIPMENT
GLASS LAMINATION • PRINTING MACHINERY • LANDSCAPE
HYDROPOWER MAINTENANCE • FIREPLACE ACCESSORIES
CHROME AND NICKEL PLATING • PAPER MILL MAINTENANCE
IN FLIGHT FOOD SERVICE EQUIPMENT • CERAMIC MFG.**