

## STAPLES, 7/16" MEDIUM CROWN 15 Gauge



- Applications: Framing, furniture frames, furring, sidewall sheathing, sub flooring, window units, crate and box assembly, boxes, crates, pallets and pallet repair
- Fits Tools: Senco M3, M4 and SQS55

NOTE: Do not use this fastener for ACQ – Pressure Treated Lumber

**Packing:** As shown below.

**Sold In:** Full box quantities only.



SEÑCO BRAND		
Length	Item#	Box Qty
1-1/2"	SNQ17BAB	5,000
1-3/4"	SNQ19BRB	5,000
2"	SNQ21BRB	5,000
2-1/4"	SNQ23BRB	5,000
2-1/2"	SNQ25BRB	5,000

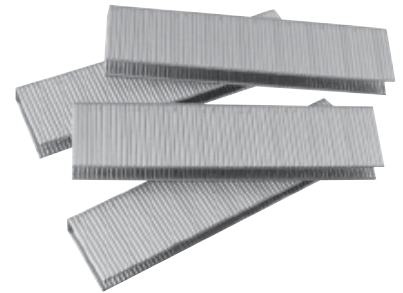

## STAPLES, 7/16" MEDIUM CROWN 16 Gauge



- Applications: Furniture and case good face frames and side stiles, desk and cabinet box build up, soffit and fascia, casebacks, countertop build up, hardwood pallets, shipping crates and boxes, sash and millwork
- Fits Tools: Senco SKS-N, SNS41, SNS50, SNS45, SNS40, M2, M1; Porter Cable MS200; Hitachi 5008 Series: Duo-Fast DS and MS7 664; Fasco F45C G-55 SS, F3C G-40CT and similar models

**Packing:** As shown below.

**Sold In:** Full box quantities only.

Length	WÜRTH BRAND		SEÑCO BRAND	
	Item#	Box Qty	Item#	Box Qty
1"	WWS16100L	10,000	SNN13BAB	5,000
1-1/4"	WWS16125L	10,000	SNN15BRB	10,000
1-1/2"	WWS16150L	10,000	SNN17BRB	10,000
1-3/4"	WWS16175L	10,000	SNN19BRB	10,000
2"	WWS16200L	10,000	SNN21BRB	10,000

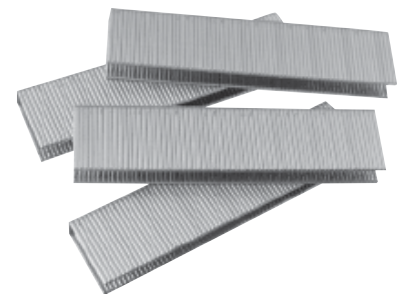

## STAPLES, 7/16" MEDIUM CROWN 17 Gauge



- Applications: Sheathing, furniture framing, roof decking, subflooring, crate and box assembly, pallets, cedar shingles, furring, metal tie-down straps, fascia and soffits, ridge beam assembly
- Fits Tools: Senco SNS200XP and SNS200XP-BST

**Packing:** As shown below.

**Sold In:** Full box quantities only.



SEÑCO BRAND		
Length	Item#	Box Qty
1-1/4"	SNO15BRBB	10,000
1-3/8"	SNO16BRBB	10,000
1-1/2"	SNO17BRBB	10,000
1-5/8"	SNO18BRBB	10,000
1-3/4"	SNO19BRBB	10,000

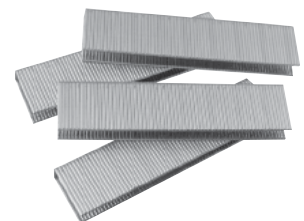

# SECTION P FASTENERS

# STAPLES

## STAPLES, 7/32" CROWN 18 Gauge



- Applications: Cabinet building, underlayment, moldings
- Fits Tools: Bostitch S32SX, T40SX-CT, SB-150SX and similar models

**Packing:** As shown below.

**Sold In:** Full box quantities only. Discount available for full case orders.

Length	WURTH BRAND			INTERCHANGE BRAND		
	Item#	Box Qty	Case Qty	Item#	Box Qty	Case Qty
3/4"	WWS18075N	5,000	50,000	-	-	-
1"	WWS18100N	5,000	50,000	-	-	-
1-3/16"	WWS18119N	3,000	30,000	IC30248-5	5,000	30,000
1-1/4"	WWS18125N	3,000	30,000	-	-	-

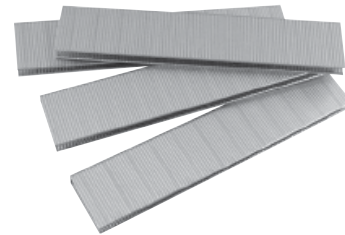

## STAPLES, 3/8" CROWN 18 Gauge



- Applications: Cabinetry and furniture, aluminum siding, mobile homes and RV's, and light metal to wood attachment
- Fits Tools: Senco SKS-M; Fasco F21T SG-25 and similar models

**Packing:** As shown below.

**Sold In:** Full box quantities only. Discount available for full case orders.

Length	WURTH BRAND			SENCO BRAND		
	Item#	Box Qty	Case Qty	Item#	Box Qty	Case Qty
5/8"	WWS18063M	5,000	65,000	SNM10BAB	5,000	45,000
3/4"	WWS18075M	5,000	40,000	SNM11BAB	5,000	40,000
1"	-	-	-	SNM13BRB	5,000	-

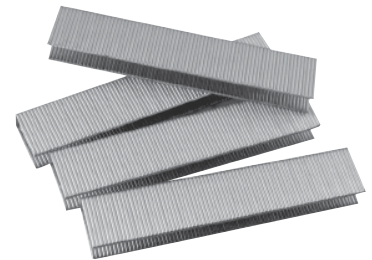

## STAPLES, 1/4" NARROW CROWN 18 Gauge



- Applications: Casebacks, pre-hung door and window units, paneling, interior trim, underlayment, drawers, lattice, moldings, door and window casings, cabinet assembly, glue blocks, backs, and cabinet box assembly
- Fits Tools: Senco FinishPro 2N1, LN4450, KMN4450M SLS25XP, SLS20L, SLS15L, SLS18L, SLS18NR, SKS-L; Porter Cable NS150A, NS100; Fasco F21P 90-250A, F21T 90-40A, F3C 90-40CT and similar models

**Packing:** As shown below.

**Sold In:** Full box quantities only. Discount available for full case orders.

Length	WURTH BRAND			SENCO BRAND			PORTER CABLE BRAND		
	Item#	Box Qty	Case Qty	Item#	Box Qty	Case Qty	Item#	Box Qty	Case Qty
1/2"	WWS18050KT	5,000	80,000	SNL08BAB	10,000	80,000	RKNS18050	5,000	50,000
5/8"	WWS18063KT	5,000	60,000	SNL10BAB	5,000	60,000	RKNS18063	5,000	50,000
3/4"	WWS18075KT	5,000	50,000	SNL11BAB	5,000	50,000	RKNS18075	5,000	50,000
7/8"	WWS18088KT	5,000	50,000	SNL12BAB	5,000	50,000	RKNS18088	5,000	50,000
1"	WWS18100KT	5,000	40,000	SNL13BAB	5,000	40,000	RKNS18100	5,000	50,000
1-1/8"	WWS18113KT	5,000	40,000	SNL14BAB	5,000	30,000	-	-	-
1-1/4"	WWS18125KT	5,000	30,000	SNL15BAB	5,000	30,000	RKNS18125	5,000	30,000
1-1/2"	WWS18150KT	5,000	30,000	SNL17BAB	5,000	30,000	RKNS18150	5,000	30,000

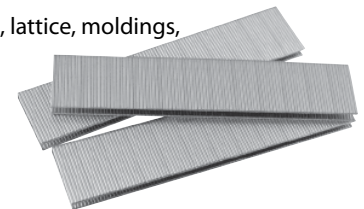

# STAPLES

# SECTION P FASTENERS

## STAPLES, 1/4" CROWN 19 Gauge



- Applications: Cabinets, casebacks, underlayment, molding and trim, lattice, and hardwood floors
- Fits Tools: Senco SLS-20K, LN3045 and similar models

**Packing:** As shown below.

**Sold In:** Full box quantities only. Discount available for full case orders.

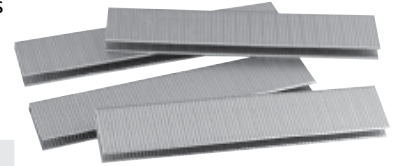

Length	WURTH BRAND			SENCO BRAND		
	Item#	Box Qty	Case Qty	Item#	Box Qty	Case Qty
3/4"	WWS19075R	5,000	90,000	SNK11BAB+	10,000	60,000

## STAPLES, 3/16" CROWN 20 Gauge



- Applications: Casebacks, molding, upholstery, and dust covers
- Fits Tools: Senco SFW10XP-E, JN5 and similar models

**Packing:** As shown below.

**Sold In:** Full box quantities only. Discount available for full case orders.

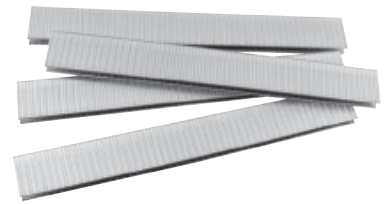

Length	WURTH BRAND			SENCO BRAND		
	Item#	Box Qty	Case Qty	Item#	Box Qty	Case Qty
1/2"	-	-	-	SNE08BAA	10,000	160,000
5/8"	WWS20063W	10,000	250,000	SNE10BAA	5,000	125,000

## STAPLES, 1/2" CROWN 20 Gauge



- Applications: Casebacks, molding, upholstery, and dust covers
- Fits Tools: Senco SFW10XP-F05, SFW10XP-F, DFP and similar models

**Packing:** As shown below.

**Sold In:** Full box quantities only. Discount available for full case orders.

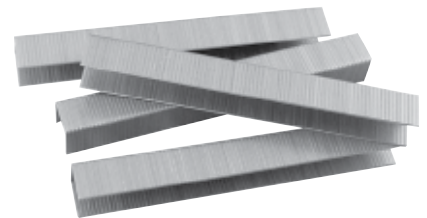

Length	WURTH BRAND			SENCO BRAND		
	Item#	Box Qty	Case Qty	Item#	Box Qty	Case Qty
3/8"	WWS20038S	5,000	100,000	SNF06BAA	10,000	100,000
1/2"	-	-	-	SNF08BAA	10,000	80,000

## STAPLES, 3/8" CROWN 22 Gauge



- Applications: Screening, light trim and moldings, cabinet backing, upholstery, and insulation
- Fits Tools: Senco SFW10XP, SFT10, SJS; Fasco F1A S3G-16, F1B S3G-16, F2 S3G-16; Spotnails BS7118, and similar models

**Packing:** As shown below.

**Sold In:** Full box quantities only. Discount available for full case orders.

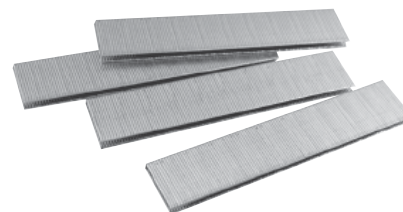

Length	INTERCHANGE BRAND		
	Item#	Box Qty	Case Qty
3/8"	IC30309	10,000	10,000
1/2"	IC30312	10,000	10,000

## SLIGHT HEAD BRAD NAILS 18 Gauge



- Applications: Cabinets, furniture, woodworking, trim, dowels and joints, cabinet door frames and panels, drawer assembly, decorative wood, and plastic pieces
- Fits Tools: Senco Finish Pro 25XP, FinishPro 18, FinishPro 15, Finish Pro 2N1, AF25, SLP20; Porter Cable BN125A, 200A, Bostitch BT125K-2, BT200K-2, SB-1850BN, Fasco F21P GN-31A, F21T GN-40A and similar models

**Packing:** As shown below.

**Sold In:** Full box quantities only. Discount available for full case orders.

Length	WURTH BRAND			SENCO BRAND		
	Item#	Box Qty	Case Qty	Item#	Box Qty	Case Qty
5/8"	WWN18063B	5,000	100,000	SNAY10EAAP	5,000	120,000
3/4"	WWN18075B	5,000	100,000	SNAY11EAAP	5,000	100,000
1"	WWN18100B	5,000	75,000	SNAY13EAAP	5,000	80,000

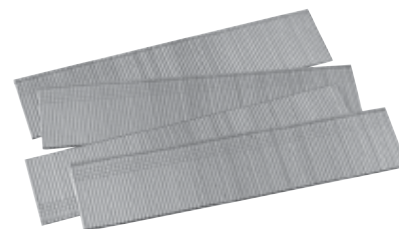

## BRAD NAILS 18 Gauge



- Applications: Carvings and ornamentals, furniture repair, cabinets and drawers, casebacks, small trim and baseboards
- Fits Tools: Senco Finish Pro 25XP, FinishPro 18, FinishPro 15, Finish Pro 2N1, AF25, SLP20, Any Senco AX tool; Porter Cable BN125A, BN200A; Bostitch BT125K-2, BT200K-2, SB-1850BN; Fasco F21P GN-31A, F21T GN-40A and similar models

**Packing:** As shown below.

**Sold In:** Full box quantities only. Discount available for full case orders.

Length	WURTH BRAND			SENCO BRAND			PORTER CABLE BRAND		
	Item#	Box Qty	Case Qty	Item#	Box Qty	Case Qty	Item#	Box Qty	Case Qty
5/8"	WWN18063A	5,000	100,000	-	-	-	RKBN18063	5,000	100,000
3/4"	WWN18075A	5,000	100,000	-	-	-	RKBN18075	5,000	100,000
1"	WWN18100A	5,000	80,000	SNAX13EAAP	5,000	80,000	RKBN18100	5,000	100,000
1-1/8"	WWN18113A	5,000	80,000	-	-	-	-	-	-
1-3/16"	WWN18119A	5,000	80,000	-	-	-	-	-	-
1-1/4"	WWN18125A	5,000	80,000	SNAX15EAAP	5,000	60,000	RKBN18125	5,000	100,000
1-1/2"	WWN18150A	5,000	60,000	SNAX17EAA	5,000	50,000	RKBN18150	5,000	100,000
1-9/16"	WWN18156A	5,000	60,000	-	-	-	-	-	-
1-5/8"	-	-	-	SNAX18EAA	5,000	50,000	-	-	-
1-3/4"	WWN18175A	5,000	40,000	-	-	-	RKBN18175	5,000	100,000
2"	WWN18200A	5,000	40,000	-	-	-	RKBN18200	5,000	100,000



SENCO BRAND			
Length	Item#	Box Qty	Case Qty
5/8"	SNA200629	1,000	5,000
1"	SNA201009	1,000	5,000
1-1/4"	SNA201259	1,000	5,000
1-1/2"	SNA201509	800	4,000
2"	SNA202009	800	4,000
Assorted Pack: 5/8", 3/4", 1" and 1-1/4"	SNA209809	300 of each size	1,500 of each size

# FINISH NAILS

# SECTION P FASTENERS

## ANGLED FINISH NAILS 15 Gauge

- Applications: Vanities, molding and trim, dowels and joints, cabinet door frames, drawer assembly, picture frames, scribe moldings, furniture repair, carvings, ornamentals, blind pinning of upholstered and trim panels, and rattan
- Fits Tools: Senco FinishPro 41XP, FinishPro 35, SFN30, SFN40, SNI; Porter Cable DA250B and similar models

**Packing:** As shown below.

**Sold In:** Full box quantities only. Discount available for full case orders.

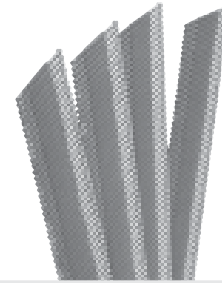

Length	WURTH BRAND			SENCO BRAND			PORTER CABLE BRAND		
	Item#	Box Qty	Case Qty	Item#	Box Qty	Case Qty	Item#	Box Qty	Case Qty
1"	WWN15100E	4,000	16,000	-	-	-	RKDA15100	4,000	16,000
1-1/4"	WWN15125E	4,000	16,000	SNDA15EPB	4,000	20,000	RKDA15125	4,000	16,000
1-1/2"	WWN15150E	4,000	16,000	SNDA17EPB	4,000	20,000	-	-	-
1-3/4"	WWN15175E	4,000	16,000	SNDA19EPB	4,000	16,000	-	-	-
2"	WWN15200E	4,000	16,000	SNDA21EPB	4,000	16,000	-	-	-
2-1/4"	WWN15225E	4,000	16,000	SNDA23EPB	4,000	12,000	-	-	-
2-1/2"	WWN15250E	4,000	16,000	SNDA25EPB	3,000	9,000	-	-	-

## ANGLED FINISH NAILS 16 Gauge

- Applications: Finish and trim, baseboard, cabinets, chair rail, decorative trim, door & window casing, furniture trim, paneling
- Fits Tools: Senco FP33MG

**Packing:** As shown below.

**Sold In:** Full box quantities only. Discount available for full case orders.

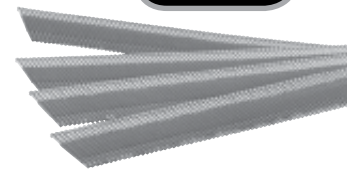

Length	Item#	Box Qty	Case Qty	Length	Item#	Box Qty	Case Qty
1-1/4"	SNRH15EAA	2,000	24,000	2"	SNRH21EAA	2,000	24,000
1-1/2"	SNRH17EAA	2,000	24,000	2-1/2"	SNRH25EAA	2,000	24,000
1-3/4"	SNRH19EAA	2,000	24,000				

## FINISH NAILS 16 Gauge

- Applications: Cabinets, shelving, drawer boxes, trim and molding build-ups, and chair railings
- Fits Tools: Senco FP32; Porter Cable FN250B, CFN250B; Bostitch FN16250K-2, SB-16644FN; Fasco F3T FN-70CT and similar models

**Packing:** As shown below.

**Sold In:** Full box quantities only. Discount available for full case orders.

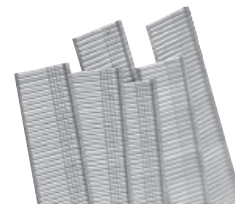

Length	WURTH BRAND			SENCO BRAND			PORTER CABLE BRAND		
	Item#	Box Qty	Case Qty	Item#	Box Qty	Case Qty	Item#	Box Qty	Case Qty
3/4"	WWN16075D	5,000	50,000	-	-	-	RKFN16075	2,500	30,000
1"	WWN16100D	5,000	30,000	-	-	-	RKFN16100	2,500	30,000
1-1/4"	WWN16125D	5,000	30,000	SNM001002	2,000	32,000	RKFN16125	2,500	30,000
1-1/2"	WWN16150D	5,000	30,000	SNM001003	2,000	24,000	RKFN16150	2,500	30,000
1-3/4"	WWN16175D	5,000	20,000	-	-	-	-	-	-
2"	WWN16200D	5,000	20,000	SNM001005	2,000	24,000	RKFN16200	2,500	30,000
2-1/2"	WWN16250D	5,000	20,000	SNM001007	2,000	24,000	-	-	-



# SECTION P FASTENERS

# MICRO BRADS

## MICRO BRADS 23 Gauge



- Applications: Cabinet doors, light trim, carvings and ornamentals and picture frames
- Fits Tools: Würth 11191W and similar models

**Packing:** As shown to the right.

**Sold In:** Full box quantities only.

Discount available for full case orders.

WÜRTH BRAND			
Length	Item#	Box Qty	Case Qty
7/8"	WWN23088B	10,000	100,000
1"	WWN23100B	10,000	100,000
1-3/16"	WWN23119B	10,000	100,000
1-3/8"	WWN23138B	10,000	100,000

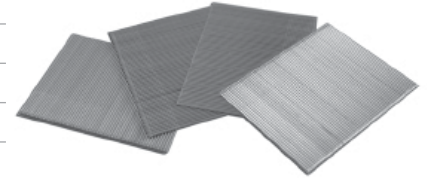

## MICRO PINS 23 Gauge



- Applications: Cabinet doors, light trim, carvings and ornamentals, and picture frames
- Fits Tools: Senco FinishPro 10, SHP10; Porter Cable PIN100; Fasco F1B A64-12/18 and similar models

**Packing:** As shown below.

**Sold In:** Full box quantities only. Discount available for full case orders.

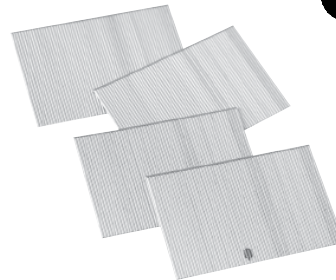

Length	WÜRTH BRAND			SEÑCO BRAND			PORTER CABLE BRAND		
	Item#	Box Qty	Case Qty	Item#	Box Qty	Case Qty	Item#	Box Qty	Case Qty
1/2"	WWN23050F10	10,000	100,000	SNA100509	2,600	13,000	RKPIN23050	2,000	2,000
5/8"	WWN23058F10	10,000	100,000	SNA100629	2,600	13,000	RKPIN23063	2,000	2,000
3/4"	WWN23075F10	10,000	100,000	SNA100759	2,600	13,000	RKPIN23075	2,000	2,000
1"	WWN23100F10	10,000	100,000	SNA101009	2,600	13,000	RKPIN23100	2,000	2,000
Assorted Pack: 1/2", 5/8", 3/4", 1"	-	-	-	SNA109809	600 of each size	3,000 of each size	-	-	-

## HEADLESS PINS 18 Gauge



- Applications: Vanities, molding and trim, dowels and joints, cabinet door frames, drawer assembly, picture frames, scribe moldings, furniture repair, carvings, ornamentals, blind pinning of upholstered and trim panels, and rattan
- Fits Tools: Senco LS 1 and similar models

**Packing:** As shown below.

**Sold In:** Full box quantities only. Discount available for full case orders.

Length	WÜRTH BRAND			SEÑCO BRAND		
	Item#	Box Qty	Case Qty	Item#	Box Qty	Case Qty
1/2"	-	-	-	SNAZ08EAA	5,000	100,000
3/4"	WWN18075C	5,000	100,000	SNAZ11EAAP	5,000	100,000
1"	WWN18100C	5,000	80,000	SNAZ13EAAP	5,000	80,000

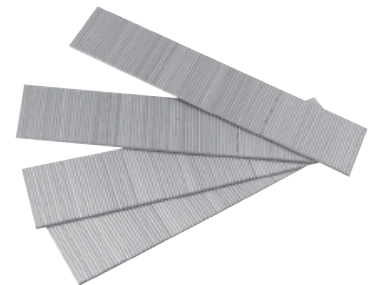

## CORRUGATED FASTENERS, 1" CROWN 25 Gauge



- Applications: Butt Joints, cabinets, door and window sashes, millwork, pallets and pallet repair, crate and box assembly
- Fits Tools: Senco SC2

**Packing:** As shown to the right.

**Sold In:** Full box quantities only.

SENCO BRAND		
Length	Item#	Box Qty
3/8"	SNX06NRA	5,000
1/2"	SNX08NRA	4,000



## SENCAMP 7/16" CROWN 25 Gauge



- Applications: Butt Joints, cabinets, curios, mirror and picture frames
- Fits Tools: Senco SC1

**Packing:** As shown to the right.

**Sold In:** Full box quantities only.

Discount available for full case orders.

SENCO BRAND			
Length	Item#	Box Qty	Case Qty
5/16"	SNY05BFA	3,000	24,000
7/16"	SNY07BFA	3,000	24,000
9/16"	SNY09BFAN	3,000	18,000



## CORRUGATED FASTENERS Saw Edge, Hammer-In



- Sharpened to a tack point on one end
- Wrought plain steel

**Packing:** As shown below.

**Sold In:** Full box quantities only.

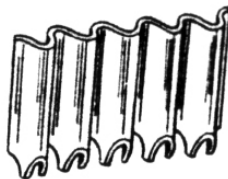

Item#	Length	Box Qty
FR315-1/2X5-M	1/2" x 5"	1,000

## HEADLESS WONDERBRADS

# Bagshaw

- No setting or pre-drilling, made of hard spring steel
- Needle point is driven just enough to hold the molding and then struck sideways
- The brad will break just below the surface of the wood

**Packing:** As shown below.

**Sold In:** Full box quantities only.

Item#	Length	Box Qty
WB7811	7/8"	1,000

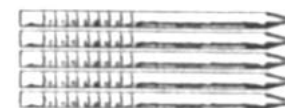

## BLIND NAILS

- Instantly hold things together with the added benefit of a mechanical fastener that is not visible
- Use for molding, trim work, drawer front installation, leveling picture frames and more
- 1" size for use assembling legs onto chairs; special diamond point helps to prevent splitting
- Simply insert the dual head nail into the magnetized nail set and set the nail. Next, tap the molding or wood onto the protruding nail and you are done

NOTE: FABLINDNAIL-1 uses a different size nail set (available in FABLINDNAILKIT-1)

**Packing and Sold in:** Full box quantities only.

Item#	Description
<b>3/8" X 3/16" BLIND NAILS</b>	
FABLINDNAILKIT	100 Blind Nails and 1 Nail Set Tool
FABLINDNAIL	100 Blind Nails Only
<b>7/16" X 7/16" BLIND NAILS</b>	
FABLINDNAIL-7/16	80 Blind Nails Only
<b>1" X 5/8" BLIND NAILS</b>	
FABLINDNAILKIT-1	80 Blind Nails & 1 Nail Set Tool
FABLINDNAIL-1	100 Blind Nails Only
<b>NAIL SET TOOL (FOR USE WITH 3/8" &amp; 7/16" BLIND NAILS ONLY)</b>	
FABLINDNAILSET	Blind Nail Tool Only



# SECTION P FASTENERS

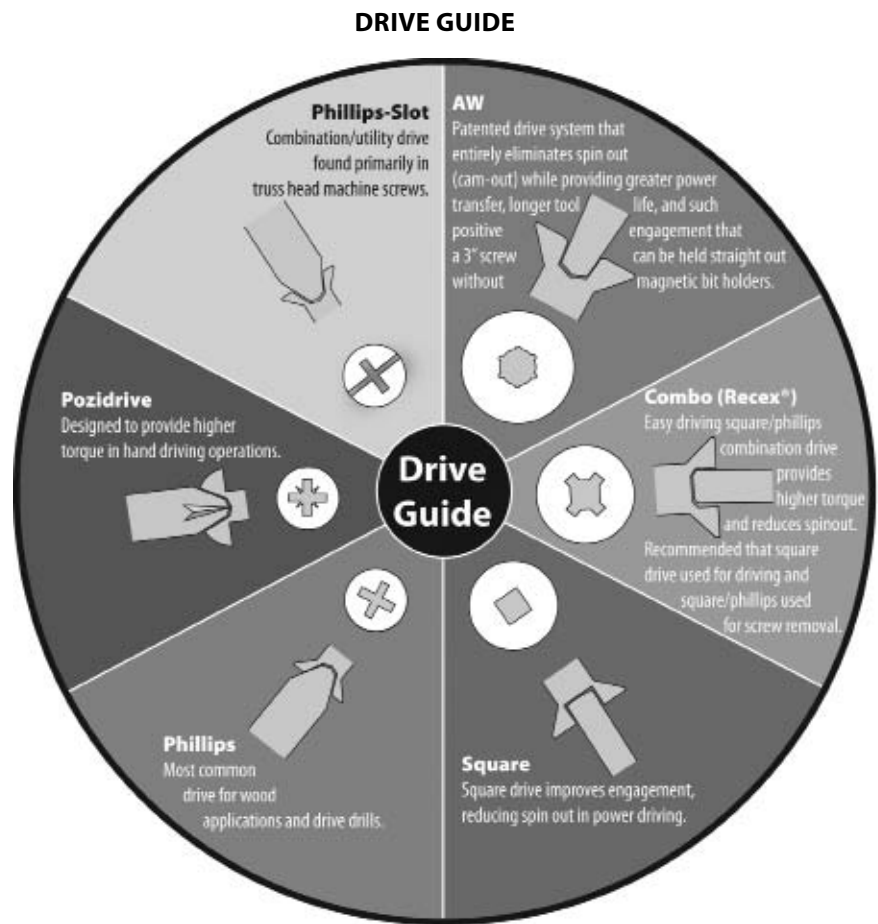

### THREAD GUIDE

**Fine Thread**  
General woodworking use, primarily with solid woods and hardwood. Requires pre-drilling and pre-countersinking.



**Hi-Lo Thread**  
The "all-purpose" thread. Designed for greater holding and less strip-out in all woods.



**Coarse Thread**  
Used in particleboard and soft woods. Best results require pre-drilling and countersinking.



**Type 17 Auger Point**  
Sharp slotted point acts as drill to eliminate pre-drilling for quicker, faster installation.



**Double Auger**  
Fast, stress-free driving; minimizes pre-drilling in hardwoods.



**Turbo Thread**  
Turbo Thread virtually eliminates pre-drilling and countersinking. With features like nibs and a patented serrated tooth thread for less driving torque and reduced splitting. Recommended for real wood only – not for use in man made materials.



**ASSY®**  
Patented "Asymmetrical / Symmetrical" thread geometry and 30° point locates screw precisely, drives fast, with 40% higher fracture torque than ordinary screws.



**ASSY® Plus**  
Patented "ASSY" thread design plus a drill bit cutter head for clean, fast, non-splitting drive into all woods and near edges.



**Flat Screw Point**  
Machine screws. Used to attach decorative hardware and in RTA applications.





# FLAT HEAD SQUARE DRIVE

# SECTION P FASTENERS



## FLAT HEAD SQUARE DRIVE, COARSE THREAD With or Without Nibs, Regular or Type 17 Auger Point

- 3/4" and 1" lengths are threaded fully - all other sizes are threaded 2/3's from bottom of the screw
- Case hardened, finishes listed below
- Uses #2 Square Drive bits

**Packing:** Standard boxes of 1,000 and bulk packs as shown below.

**Sold In:** Full box quantities only. Discount available for bulk box orders.

WITHOUT NIBS, REGULAR POINT (LUBRICATED)					
Length x Gauge	Finish	Std Box Qty Item #		Bulk Box Qty Item #	
3/4" x 6	Lubricated	1,000	WW39215	15,000	WW39217
1" x 8	Lubricated	1,000	WW39230	10,000	WW39232
1-1/4" x 8	Lubricated	1,000	WW39235	7,500	WW39237
1-1/2" x 8	Lubricated	1,000	WW39240	5,000	WW39242
1-3/4" x 8	Lubricated	1,000	WW39250	4,000	WW39252
2" x 8	Lubricated	1,000	WW39255	3,500	WW39257
2-1/4" x 8	Lubricated	-	-	3,000	WW39262
2-1/2" x 8	Lubricated	1,000	WW39265	2,500	WW39267
3" x 8	Lubricated	1,000	-	1,500	WW39270



Without Nibs,  
With Regular Point

WITH NIBS, TYPE 17 AUGER POINT (BLACK)					
Length x Gauge	Finish	Std Box Qty Item #		Bulk Box Qty Item #	
1" x 8	Black	1,000	WW37100	11,000	WW37120
1-1/4" x 8	Black	1,000	WW37140	9,000	WW37160
1-1/2" x 8	Black	1,000	WW37180	7,000	WW37200
1-5/8" x 8	Black	1,000	WW37220	5,500	WW37240
1-3/4" x 8	Black	1,000	WW37260	4,800	WW37265
2" x 8	Black	1,000	WW37280	4,000	WW37300
2-1/2" x 8	Black	1,000	WW37340	2,500	WW37350
3" x 8	Black	1,000	WW37380	2,000	WW37390



With Nibs,  
With Type 17 Point

WITH NIBS, TYPE 17 AUGER POINT (ZINC)					
Length x Gauge	Finish	Std Box Qty Item #		Bulk Box Qty Item #	
1" x 8	Zinc	1,000	WW31600	11,000	WW31700
1-1/4" x 8	Zinc	1,000	WW31800	9,000	WW31900
1-1/2" x 8	Zinc	1,000	WW38800	7,000	WW38900
1-5/8" x 8	Zinc	1,000	WW39000	5,500	WW39100
1-3/4" x 8	Zinc	1,000	WW39110	4,800	WW39120
2" x 8	Zinc	1,000	WW39200	4,000	WW39300
2-1/4" x 8	Zinc	1,000	WW39400	3,500	WW39500
2-1/2" x 8	Zinc	1,000	WW39710	2,500	WW39715
3" x 8	Zinc	1,000	WW39800	2,000	WW39900



## FLAT HEAD RECEX (COMBO PHILLIPS & SQUARE) DRIVE, COARSE THREAD

With or Without Nibs, Regular Point

- 3/4" and 1" lengths are threaded fully - all other sizes are threaded 2/3's from bottom of the screw
- Case hardened, finishes listed below
- Uses #2 Square Drive bits to insert; #2 Phillips Drive bits can be used for aftermarket adjustment

**Packing:** Standard boxes of 1,000 and bulk packs as shown below.

**Sold In:** Full box quantities only. Discount available for bulk box orders.

### WITHOUT NIBS, REGULAR POINT (LUBRICATED)

Length x Gauge	Finish	Std Box Qty		Bulk Box Qty	
		Item #	Item #	Item #	Item #
3/4" x 6	Lubricated	1,000	WW38810	-	-
1" x 8	Lubricated	1,000	WW38820	10,000	WW38822
1-1/4" x 8	Lubricated	1,000	WW38825	7,500	WW38827
1-1/2" x 8	Lubricated	1,000	WW38830	5,000	WW38832
1-3/4" x 8	Lubricated	-	-	4,000	WW38837
2" x 8	Lubricated	1,000	WW38842	3,500	WW38840
2-1/4" x 8	Lubricated	-	-	3,000	WW38847
2-1/2" x 8	Lubricated	-	-	2,500	WW38852
3" x 8	Lubricated	-	-	1,500	WW38870

### WITHOUT NIBS, REGULAR POINT (ZINC)

Length x Gauge	Finish	Std Box Qty		Bulk Box Qty	
		Item #	Item #	Item #	Item #
1" x 8	Zinc	-	-	10,000	WW38821
1-1/4" x 8	Zinc	1,000	WW38925	7,500	WW38927
1-1/2" x 8	Zinc	1,000	WW38930	5,000	WW38932
1-3/4" x 8	Zinc	-	-	4,000	WW38937
2" x 8	Zinc	-	-	3,500	WW38942
2-1/2" x 8	Zinc	-	-	2,500	WW38955
3" x 8	Zinc	-	-	1,500	WW38965

### WITH NIBS, REGULAR POINT (LUBRICATED)

Length x Gauge	Finish	Std Box Qty		Bulk Box Qty	
		Item #	Item #	Item #	Item #
1" x 8	Lubricated	1,000	WW39010	10,000	WW39008
1-1/4" x 8	Lubricated	1,000	WW39020	7,500	WW39022
1-1/2" x 8	Lubricated	1,000	WW39025	5,000	WW39027
1-3/4" x 8	Lubricated	1,000	WW39030	4,000	WW39032
2" x 8	Lubricated	1,000	WW39035	3,500	WW39037
2-1/2" x 8	Lubricated	-	-	2,500	WW39055
3" x 8	Lubricated	-	-	1,500	WW39075



Without Nibs,  
With Regular Point



With Nibs,  
With Regular Point

## FLAT HEAD RECEX (COMBO PHILLIPS & SQUARE) DRIVE, COARSE THREAD With Nibs and Type 17 Auger Point



- 3/4" and 1" lengths are threaded fully - all other sizes are threaded 2/3's from bottom of the screw
- Case hardened, finishes listed below
- Uses #2 Square Drive bits to insert; #2 Phillips Drive bits can be used for aftermarket adjustment

**Packing:** Standard boxes of 1,000 and bulk packs as shown below.

**Sold In:** Full box quantities only. Discount available for bulk box orders.

### WITH NIBS, TYPE 17 AUGER POINT (BLACK)

Length x Gauge	Finish	Std Box Qty Item #		Bulk Box Qty Item #	
1" x 8	Black	1,000	WW36710	11,000	WW36715
1-1/4" x 8	Black	1,000	WW36720	9,000	WW36725
1-1/2" x 8	Black	1,000	WW36730	7,000	WW36735
1-3/4" x 8	Black	1,000	WW36750	4,800	WW36755
2" x 8	Black	1,000	WW36760	4,000	WW36765
2-1/4" x 8	Black	1,000	WW36770	3,500	WW36775
2-1/2" x 8	Black	1,000	WW36780	2,500	WW36785
3" x 8	Black	1,000	WW36790	2,000	WW36793

### WITH NIBS, TYPE 17 AUGER POINT (ZINC)

Length x Gauge	Finish	Std Box Qty Item #		Bulk Box Qty Item #	
1" x 8	Zinc	1,000	WW36820	-	-
1-1/4" x 8	Zinc	1,000	WW36822	9,000	WW36830
1-1/2" x 8	Zinc	1,000	WW36835	7,000	WW36840
1-5/8" x 8	Zinc	1,000	WW36845	5,500	WW36850
2" x 8	Zinc	1,000	WW36870	4,000	WW36875
2-1/4" x 8	Zinc	-	-	3,500	WW36885
2-1/2" x 8	Zinc	1,000	WW36890	2,500	WW36895
3" x 8	Zinc	-	-	2,000	WW36910



With Nibs,  
With Type 17 Auger Point

## FLAT HEAD COMBO PHILLIPS & SQUARE DRIVE, COARSE THREAD With Nibs and Double Auger Point



- Double Auger for faster, stress-free driving; minimizes pre-drilling in hardwoods
- Case hardened, Lubricated
- Uses #2 Square Drive bits to insert; #2 Phillips Drive bits can be used for aftermarket adjustment

**Packing:** Standard boxes of 1,000 and bulk packs as shown below.

**Sold In:** Full box quantities only. Discount available for bulk box orders.

### WITH NIBS, DOUBLE AUGER POINT (LUBRICATED)

Length x Gauge	Finish	Std Box Qty Item #		Bulk Box Qty Item #	
1-1/4" x 8	Lubricated	1,000	WL5B81250P	9,000	WL5B81250B
1-1/2" x 8	Lubricated	1,000	WL5B81500P	7,000	WL5B81500B
1-5/8" x 8	Lubricated	1,000	WL5B81750P	5,000	WL5B81750B
2" x 8	Lubricated	1,000	WL5B82000P	4,000	WL5B82000B
2-1/2" x 8	Lubricated	500	WL5B82500P	2,500	WL5B82500B
3" x 8	Lubricated	-	-	2,000	WL5B83000B



With Nibs,  
with Double Auger

## FLAT HEAD RECEX (COMBO PHILLIPS & SQUARE) DRIVE, TURBO THREAD With Nibs, Regular or Type 17 Auger Point



- Patented serrated tooth turbo thread allows for quick starting, reduced splitting, and less drive torque
- Use in all wood working applications: assembly, face frame, slides, hinges and hardware
- 3/4" and 1" lengths are threaded fully - all other sizes are threaded 2/3' s from bottom of the screw
- Case hardened, lubricated
- Uses #2 Square Drive bits to insert; #2 Phillips Drive bits can be used for aftermarket adjustment

**Packing:** Standard boxes of 1,000 and bulk packs as shown below.

**Sold In:** Full box quantities only. Discount available for bulk box orders.

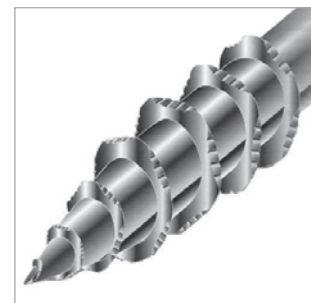

Serrated thread for quick start and reduced splitting.

### WITH NIBS, REGULAR POINT (LUBRICATED)

Length x Gauge	Finish	Std Box Qty Item #		Bulk Box Qty Item #	
3/4" x 8	Lubricated	-	-	15,000	WW31950
1" x 8	Lubricated	1,000	WW32000	10,000	WW32100
1-1/8" x 8	Lubricated	1,000	WW32200	8,000	WW32300
1-1/4" x 8	Lubricated	1,000	WW32400	7,500	WW32500
1-1/2" x 8	Lubricated	1,000	WW32800	5,000	WW32900
1-3/4" x 8	Lubricated	1,000	WW33000	4,000	WW33100
2" x 8	Lubricated	1,000	WW33200	3,500	WW33300
2-1/4" x 8	Lubricated	-	-	3,000	WW33500
2-1/2" x 8	Lubricated	1,000	WW33600	2,500	WW33700
2-3/4" x 8	Lubricated	1,000	WW33800	2,000	WW33900
3" x 8	Lubricated	1,000	WW34000	1,500	WW34100



With Nibs,  
With Regular Point

### WITH NIBS, TYPE 17 AUGER POINT (LUBRICATED)

Length x Gauge	Finish	Std Box Qty Item #		Bulk Box Qty Item #	
2" x 8	Lubricated	-	-	3,500	WW33350



With Nibs,  
With Type 17 Auger Point



## FLAT HEAD PHILLIPS DRIVE, COARSE THREAD With or Without Nibs, Regular or Type 17 Auger Point

- 3/4" and 1" lengths are threaded fully - all other sizes are threaded 2/3's from bottom of the screw
- Case hardened, finishes listed below
- Uses #2 Phillips Drive bits

**Packing:** Standard boxes of 1,000 and bulk packs as shown below.

**Sold In:** Full box quantities only. Discount available for bulk box orders.

WITHOUT NIBS, REGULAR POINT (LUBRICATED OR BLACK)					
Length x Gauge	Finish	Std Box Qty Item #		Bulk Box Qty Item #	
3/4" x 6	Lubricated	1,000	WW38720	15,000	WW38710
3/4" x 8	Black	1,000	WW38330	-	-
1" x 8	Lubricated	1,000	WW38730	10,000	WW38732
1-1/4" x 8	Black	1,000	WW38350	-	-
1-1/4" x 8	Lubricated	1,000	WW38735	7,500	WW38738
1-1/2" x 8	Lubricated	1,000	WW38740	5,000	WW38742
1-5/8" x 8	Black	-	-	5,500	WW38375
1-3/4" x 8	Lubricated	1,000	WW38745	4,000	WW38747
2" x 8	Black	-	-	4,000	WW38395
2" x 8	Lubricated	1,000	WW38750	3,500	WW38752
2-1/2" x 8	Black	1,000	WW38410	2,500	WW38415
2-1/2" x 8	Lubricated	-	-	2,500	WW38762
3" x 8	Black	1,000	WW38425	-	-



Without Nibs,  
With Regular Point

Length x Gauge	WITH NIBS, TYPE 17 AUGER POINT (BLACK OR ZINC)							
	BLACK FINISH				ZINC FINISH			
	Std Box Qty Item #		Bulk Box Qty Item #		Std Box Qty Item #		Bulk Box Qty Item #	
1" x 8	1,000	WW34200	11,000	WW34220	1,000	WW30000	11,000	WW30100
1-1/4" x 8	1,000	WW34240	9,000	WW34260	1,000	WW30200	9,000	WW30300
1-1/2" x 8	1,000	WW34280	7,000	WW34300	1,000	WW30400	7,000	WW30500
1-5/8" x 8	1,000	WW34320	5,500	WW34340	1,000	WW30600	5,500	WW30700
1-3/4" x 8	1,000	WW34350	4,800	WW34360	1,000	WW30795	4,800	WW30798
2" x 8	1,000	WW34400	4,000	WW34420	1,000	WW30800	4,000	WW30900
2-1/4" x 8	1,000	WW34440	3,500	WW34460	-	-	3,500	WW31100
2-1/2" x 8	1,000	WW34480	2,500	WW34500	1,000	WW31200	2,500	WW31300
3" x 8	1,000	-	2,000	WW34580	1,000	WW31400	2,000	WW31500



With Nibs,  
With Type 17 Auger Point



# SECTION P FASTENERS

# FLAT HEAD PHILLIPS



## FLAT HEAD PHILLIPS DRIVE , TWINFAST THREAD Without Nibs, With Sharp Point

- Twinfast screws drive 66% faster than a standard wood screw; double lead threads drive into the hardest woods
- Case hardened, black
- 8 gauge screws use #2 Phillips bits; 10 gauge screws use #3 Phillips bits

**Packing:** Standard boxes of 1,000 and bulk packs as shown on right.

**Sold In:** Full box quantities only.

Discount available for bulk box orders.



WITHOUT NIBS, WITH SHARP POINT (BLACK FINISH)					
Length x Gauge	Finish	Std Box Qty Item #		Bulk Box Qty Item #	
1" x 8	Black	-	-	11,000	WW30912
1-1/4" x 8	Black	1,000	WW30915	9,000	WW30920
1-1/2" x 8	Black	1,000	WW30925	7,000	WW30930
1-3/4" x 8	Black	-	-	4,800	WW30940
2" x 8	Black	1,000	WW30955	3,500	WW30960
2-1/4" x 8	Black	-	-	3,000	WW30970
2-1/2" x 8	Black	-	-	2,800	WW30980
3" x 8	Black	-	-	2,000	WW30985
3" x 10	Black	-	-	1,500	WW30990

## FLAT HEAD AW® DRIVE, ASSY THREAD With or Without Nibs Sharp 30° Point or Drill Point



- Patented high tech ASSY thread design provides faster driving and 40% stronger hold
- Patented AW drive system delivers superior torque while virtually eliminating cam-out
- All screw boxes are packaged with one AW insert drive bit
- Thin, lubricated shank reduces wood splitting
- Case hardened, zinc

**Packing:** As shown below.

**Sold In:** Full box quantities only.



ASSY: Without Nibs,  
With Sharp 30° Point



Ecofast ASSY: With Nibs,  
With Sharp 30° Point



ASSY Plus: With Nibs,  
With Type 2 Drill Point

Length x Gauge	Repl. Bit	Box Qty	ASSY No Nibs, Sharp 30° Point	Ecofast ASSY With Nibs, Sharp 30° Point	ASSY Plus With Nibs, Type 2 Drill Point
1/2" x 6	WWAW10	1,000	WW1513513	-	-
5/8" x 6	WWAW10	1,000	WW17043516	-	-
3/4" x 6	WWAW10	1,000	WW17043520	-	-
1" x 8	WWAW20	1,000	WW1511425	WW17014025	WW165914025
1-3/16" x 8	WWAW20	500	-	WW17014030	WW165914030
1-3/8" x 8	WWAW20	500	-	WW17014035	WW165914035
1-9/16" x 8	WWAW20	500	WW1511440	WW17014040	WW165914040
1-3/4" x 8	WWAW20	500	WW1511445	WW17014045	WW165914045
2" x 8	WWAW20	500	WW1511450	WW17014050	WW165914050
2-3/8" x 8	WWAW20	250	WW1511460	WW17014060	WW165914060 *
2-3/4" x 8	WWAW20	250	-	WW17014070	WW165914070
3-1/8" x 9	WWAW20	200	-	-	WW165914580

\* Note: 500 per box.

## WASHER HEAD RECEX (COMBO PHILLIPS & SQUARE) DRIVE, TURBO THREAD



### Regular Point

- Round Washerhead typically used in soft woods to prevent head from sinking into wood
- Patented serrated tooth turbo thread allows for quick starting, reduced splitting, and less drive torque. Used in all woodworking applications: assembly, face frame, slides, hinges and hardware
- 3/4" and 1" lengths are threaded fully - all other sizes are threaded 2/3's from bottom of the screw
- Case hardened, lubricated
- Uses #2 Square Drive bits to insert; #2 Phillips Drive bits can be used for aftermarket adjustment

**Packing:** Standard boxes of 1,000 and bulk packs as shown below.

**Sold In:** Full box quantities only. Discount available for bulk box orders.

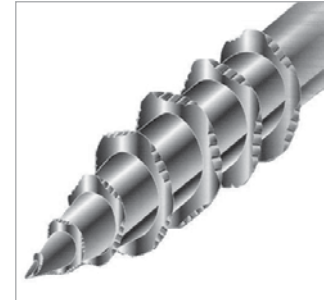

Serrated thread for quick start and reduced splitting.

REGULAR POINT (LUBRICATED)					
Length x Gauge	Finish	Std Box Qty		Bulk Box Qty	
		Item #	Item #	Item #	Item #
1" x 8	Lubricated	1,000	WW34600	8,000	WW34700
1-1/8" x 8	Lubricated	1,000	WW34800	6,000	WW34900
1-1/4" x 8	Lubricated	1,000	WW35000	6,500	WW35100
1-3/8" x 8	Lubricated	1,000	WW35200	5,000	WW35300
1-1/2" x 8	Lubricated	1,000	WW35400	5,000	WW35500
1-3/4" x 8	Lubricated	1,000	WW35600	4,000	WW35700
2" x 8	Lubricated	1,000	WW35800	3,000	WW35900
2-1/4" x 8	Lubricated	1,000	WW36000	2,000	WW36100
2-1/2" x 8	Lubricated	1,000	WW36200	2,000	WW36300
2-3/4" x 8	Lubricated	1,000	WW36400	1,500	WW36500
3" x 8	Lubricated	1,000	WW36600	1,500	WW36700



With Regular Point

## BUGLE HEAD PHILLIPS DRIVE, COARSE THREAD



### Sharp Point

- Fully threaded
- Case hardened, black
- Uses #2 Phillips Drive bits

**Packing:** Standard boxes and bulk packs as shown on right.

**Sold In:** Full box quantities only.

Discount available for bulk box orders.



BLACK FINISH				
Length x Gauge	Std Box Qty		Bulk Box Qty	
	Item #		Item #	
1" x 7	1,000	WW19000	10,000	WW19010
1-1/8" x 7	1,000	WW19100	10,000	WW19110
1-1/4" x 7	1,000	WW19200	8,000	WW19210
1-5/8" x 7	1,000	WW19300	5,000	WW19310
2" x 7	1,000	WW19400	3,500	WW19410
2-1/4" x 7	1,000	WW19500	3,000	WW19510
2-1/2" x 8	1,000	WW21000	2,500	WW21100
3" x 8	2,000	WW21400	-	-
4" x 10	1,000	WW29340	-	-
6" x 10	500	WW29500	-	-

## BUGLE HEAD SQUARE DRIVE, COARSE THREAD



### Sharp Point

- Fully threaded
- Case hardened, black
- Uses #2 Square Drive bits

**Packing:** Standard boxes as shown below.

**Sold In:** Full box quantities only.



BLACK FINISH				
Length x Gauge	Std Box Qty		Bulk Box Qty	
	Item #		Item #	
1" x 7	1,000	WW22000	-	-
1-5/8" x 7	1,000	WW22300	5,500	WW22400
2-1/2" x 8	-	-	3,000	WW22700
2-1/2" x 9	1,000	WW22900	2,000	WW23000
3" x 9	1,000	WW23200	2,000	WW23300

## BUGLE HEAD PHILLIPS DRIVE, FINE THREAD



### Sharp Point

- Fully threaded the length of the screw
- Case hardened, black
- Uses #2 Phillips Drive bits

**Packing:** Standard boxes of 1,000 and bulk packs as shown on right.

**Sold In:** Full box quantities only.

Discount available for bulk box orders.



BLACK FINISH		
Length x Gauge	Std Box Qty	
	Item #	
1" x 7	10,000	WW29100
1-1/4" x 7	8,000	WW29200
1-5/8" x 7	5,000	WW29220
2" x 7	3,500	WW29240
3" x 8	2,000	WW29280
3-1/2" x 10	1,500	WW29300
4" x 10	1,000	WW29320

## MODIFIED PAN HEAD SQUARE DRIVE, FINE THREAD

Type 17 Auger Point, #6 or #7 Gauge

- Standard fine thread for hardwoods such as Oak and Maple
  - Case hardened, lubricated
  - Uses #2 Square Drive bits
- Packing:** Standard boxes of 1,000 and bulk packs as shown on right.
- Sold In:** Full box quantities only.  
Discount available for bulk box orders.

LUBRICATED FINISH 6 GAUGE				
Length x Gauge	Std Box Qty Item #		Bulk Box Qty Item #	
1-1/4" x 6	1,000	WL3B61250P	8,000	WL3B61250B
1-1/2" x 6	1,000	WL3B61500P	7,000	WL3B61500B
LUBRICATED FINISH 7 GAUGE				
1-1/4" x 7*	1,000	WW16000	7,500	WW16100
1-1/2" x 7	1,000	WW16200	6,000	WW16300



## MODIFIED PAN HEAD SQUARE DRIVE, FINE THREAD

Double Auger Point, #6 & #7 Gauge

- Minimizes pre-drilling in even the hardest woods
  - Case hardened, lubricated
  - Uses #2 Square Drive bits
- Packing:** Standard boxes of 1,000 and bulk packs as shown on right.
- Sold In:** Full box quantities only.  
Discount available for bulk box orders.

LUBRICATED FINISH 6 GAUGE				
Length x Gauge	Std Box Qty Item #		Bulk Box Qty Item #	
1-1/4" x 6	1,000	WL3D61250P	8,000	WL3D61250B
1-1/2" x 6	1,000	WL3D61500P	7,000	WL3D61500B
LUBRICATED FINISH 7 GAUGE				
1-1/4" x 7	1,000	WW16600	7,500	WW16500
1-1/2" x 7	1,000	WW16800	6,000	WW16700



## MODIFIED PAN HEAD SQUARE DRIVE, HI-LO THREAD

Type 17 Auger Point, #7 Gauge

- All purpose screw with Hi-Lo thread for greater holding power and less strip out in hardwoods, medium woods, and soft woods
  - Case hardened, lubricated
  - Uses #2 Square Drive bits
- Packing:** Standard boxes of 1,000 and bulk packs as shown on above.
- Sold In:** Full box quantities only. Discount available for bulk box orders.

LUBRICATED FINISH				
Length x Gauge	Std Box Qty Item #		Bulk Box Qty Item #	
1-1/4" x 7	1,000	WW15000	7,500	WW15100
1-1/2" x 7	1,000	WW15200	6,000	WW15300



## MODIFIED PAN HEAD SQUARE DRIVE, COARSE THREAD

Extra Long Type 17 Auger Point, #7 Gauge

- Features an extra long aggressive cutting point that cuts through the toughest materials
  - Elongated cutting flute greatly reduces splitting and cracking
  - Case hardened, lubricated
  - Uses #2 Square Drive bits
- Packing:** Standard boxes of 1,000 and bulk packs as shown on above.
- Sold In:** Full box quantities only. Discount available for bulk box orders.

LUBRICATED FINISH				
Length x Gauge	Std Box Qty Item #		Bulk Box Qty Item #	
1-1/4" x 7	1,000	WW17000	7,500	WW17100
1-1/2" x 7	1,000	WW17200	6,000	WW17300



# SECTION P FASTENERS

## MODIFIED PAN HEAD AW® DRIVE, ASSY® THREAD

Sharp 30° Point, #6 Gauge



- Thin shank reduces splitting
- All screws are packaged with one AW® insert drive bit
- Case hardened, zinc
- Uses WWAW20 drive bits



**Packing:** Standard box quantities as shown on right.

**Sold In:** Full box quantities only.

ZINC FINISH			
Length x Gauge	Replacement Bit	Std Box Qty Item #	
1-1/4" x 6	WWAW20	1,000	WW15303530
1-3/8" x 6	WWAW20	1,000	WW15303535

## PAN HEAD PHILLIPS OR SQUARE DRIVE, FINE THREAD

Type 17 Auger Point, #6 Gauge



- Standard fine thread for hardwoods such as Oak and Maple
- Case hardened, black
- Uses #2 Phillips or Square Drive bits



**Packing:** Standard box of 1,000 and bulk packs as shown on right.

**Sold In:** Full box quantities only.

Discount available for bulk box orders.

Length x Gauge	PHILLIPS DRIVE				SQUARE DRIVE			
	BLACK FINISH							
	Std Box Qty Item #		Bulk Box Qty Item #		Std Box Qty Item #		Bulk Box Qty Item #	
1-1/4" x 6	1,000	WW10200	10,000	WW18000	1,000	WW12500	10,000	WW12520
1-1/2" x 6	1,000	WW10500	8,500	WW18200	1,000	WW12800	8,500	WW12820

## PAN HEAD PHILLIPS OR SQUARE DRIVE, COARSE THREAD

Type 17 Auger Point, #6 & #7 Gauge



- Coarse thread for excellent holding in soft woods, MDF and particleboard
- Case hardened, lubricated & black
- Uses #2 Phillips or Square Drive bits



**Packing:** Standard boxes of 1,000 and bulk packs as shown on right.

**Sold In:** Full box quantities only.

Discount available for bulk box orders.

Length x Gauge	PHILLIPS DRIVE				SQUARE DRIVE			
	LUBRICATED FINISH				BLACK FINISH			
	Std Box Qty Item #		Bulk Box Qty Item #		Std Box Qty Item #		Bulk Box Qty Item #	
1-1/4" x 6	1,000	WW10000	10,000	WW10100	-	-	-	-
1-1/4" x 7	-	-	-	-	1,000	WW12000	7,500	WW12100
1-1/2" x 7	-	-	-	-	1,000	WW12200	6,000	WW12300

## ROUND WASHER HEAD SQUARE OR RESEX (COMBO PHILLIPS & SQUARE) DRIVE, COARSE THREAD

Type 17 Auger Point, #8 Gauge



- Coarse thread for excellent holding in soft woods, MDF, and particleboard
- Round washer head prevents the head from crushing into the bottom of the face frame hole
- Case hardened, lubricated and black
- Uses #2 Square Drive bits

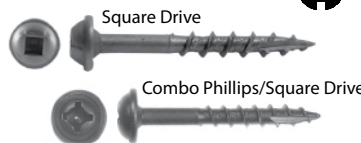

**Packing:** Standard boxes of 1,000 and bulk packs as shown on right.

**Sold In:** Full box quantities only.

Discount available for bulk box orders.

Length x Gauge	SQUARE DRIVE				COMBO PHILLIPS & SQUARE DRIVE			
	LUBRICATED FINISH				BLACK FINISH			
	Std Box Qty Item #		Bulk Box Qty Item #		Std Box Qty Item #		Bulk Box Qty Item #	
1-1/4" x 8	1,000	WL3F81250P	8,000	WL3F81250B	1,000	WW18500	7,000	WW18520
1-1/2" x 8	1,000	WL3F81500P	7,000	WL3F81500B	1,000	WW18600	5,000	WW18620

## ROUND WASHER HEAD SQUARE DRIVE, FINE THREAD

Type 17 Auger Point, #7 Gauge



- Standard fine thread for hardwoods such as Oak and Maple
- Round washerhead prevents the head from crushing into the bottom of the face frame hole
- Case hardened, black
- Uses #2 Square Drive bits



**Packing:** Standard box of 1,000 and bulk packs as shown on right.

**Sold In:** Full box quantities only. Discount available for bulk box orders.

Length x Gauge	BLACK FINISH			
	Std Box Qty Item #		Bulk Box Qty Item #	
1-1/4" x 7	1,000	WW18705	8,000	WW18700
1-1/2" x 7	1,000	-	6,000	WW18750



# WASHER HEAD

# SECTION P FASTENERS

## WASHER HEAD COMBO PHILLIPS & SQUARE DRIVE, QUICKCUTTER THREAD



### Type 17 Auger Point

- Case hardened, finishes listed below
- Uses #2 Square Drive bits to insert & #2 Phillips Drive bits for aftermarket adjustment

**Packing:** Standard boxes and bulk packs as shown below.

**Sold In:** Full box quantities only. Discount available for bulk box orders.



Length x Gauge	ZINC WITH ZINC HEAD				ZINC WITH WHITE HEAD			
	Std Box Qty Item #		Bulk Box Qty Item #		Std Box Qty Item #		Bulk Box Qty Item #	
2-1/2" x 10	500	WL7D102500ZP	1,500	WL7D102500ZB	-	-	1,500	WL7D102500WB
3" x 10	500	WL7D103000ZP	1,500	WL7D103000ZB	500	WL7D103000WP	1,500	WL7D103000WB
3-1/2" x 10	-	-	1,000	WL7D103500ZB	-	-	-	-

## WASHER HEAD PHILLIPS DRIVE, HI-LO THREAD



### Special Cutter

- Self piercing point for instant start and reduced splitting
- Uses #3 Phillips Drive bits

**Packing:** Standard boxes and bulk packs as shown on right.

**Sold In:** Full box quantities only.

Discount available for bulk box orders.



Length x Gauge	ZINC FINISH			
	Std Box Qty Item #		Bulk Box Qty Item #	
3" x 14	100	WW38000	1,000	WW38100

## WASHER HEAD PHILLIPS DRIVE, HI-LO THREAD



### QX2™ Auger Point

- Self piercing point for instant start and reduced splitting
- Uses #3 Phillips Drive bits

**Packing:** Standard boxes and bulk packs as shown on right.

**Sold In:** Full box quantities only.

Discount available for bulk box orders.



Length x Gauge	ZINC FINISH			
	Std Box Qty Item #		Bulk Box Qty Item #	
2-1/2" x 14	100	WL7E142500P	1,500	WL7E142500B
3" x 14	100	WL7E143000P	-	-

## WASHER HEAD RECEX (COMBO PHILLIPS & SQUARE DRIVE), COARSE THREAD



### Regular Point

- Case hardened, black & zinc
- Uses #2 Square drive bit to insert & #2 Phillips Drive bit for aftermarket adjustment

**Packing:** Standard box quantities as shown on below.

**Sold In:** Full box quantities only.



REGULAR POINT, .375" DIAMETER HEAD					REGULAR POINT, .443" DIAMETER HEAD						
BLACK FINISH			ZINC FINISH		ZINC FINISH				ZINC FINISH W/ WHITE HEAD		
Length x Gauge	Std Box Qty Item #		Std Box Qty Item #		Length x Gauge	Std Box Qty Item #		Bulk Box Qty Item #		Std Box Qty Item #	
1-1/8" x 8	-	-	6,500	WW82600	2-1/2" x 10	500	WW39350	1,500	WW39360	1,500	WW39320
2-1/2" x 8	2,000	WW38990	2,000	WW39770	3" x 10	500	WW39370	1,500	WW30995	1,000	WW39335
3" x 8	1,500	WW38995	1,500	WW39785	3-1/2" x 10	800	WW39385	-	-	-	-

## TRUSS HEAD PHILLIPS DRIVE, FINE THREAD (2/3 THREAD) Needle Point (For Light Metal Studs and Sheetmetal)



- #8 gauge needle point for light metal studs and sheetmetal
- Large truss head provides large bearing surface and hides rough screw hole edges
- Case hardened, finishes listed on right
- Uses #2 Phillips Drive bits



**Packing:** Standard box quantities of 2,000.  
**Sold In:** Full box quantities only.

Length x Gauge	ZINC WITH SAND HEAD		ZINC WITH WHITE HEAD		ZINC WITH ZINC HEAD	
	Std Box Qty	Item #	Std Box Qty	Item #	Std Box Qty	Item #
2-1/2" x 8	2,000	WW39150	2,000	WW39140	2,000	WW39160

## TRUSS HEAD PHILLIPS DRIVE, FINE THREAD (FULL THREAD) #2 Drill Point (For Heavier Gauge Metal Studs)



- #2 drill point for use on heavier gauge metal studs. Eliminates the need for pilot hole/pre drilling studs
- Large truss head provides large bearing surface and hides rough screw hole edges
- Case hardened, finishes listed on right
- Uses #3 Phillips Drive bits



**Packing:** Standard boxes and bulk packs as shown on right.

**Sold In:** Full box quantities only.

Discount available for bulk box orders.

Length x Gauge	ZINC W/WHITE HEAD		ZINC W/ZINC HEAD		
	Std Box Qty	Item #	Std Box Qty	Item #	Bulk Box Qty
2-1/2" x 10	500	WW39180	500	WW39190	2,000
					WW39185

## TRUSS HEAD PHILLIPS DRIVE, COARSE THREAD (1/2 THREAD) Needle Point (For Wood Studs)



- Deep thread for secure fastening to wood studs
- Large truss head provides large bearing surface and hides rough screw hole edges
- 1/2" head allows cabinet to "float" for final adjustment
- Case hardened, finishes listed below
- Uses #3 Phillips Drive bits



**Packing:** Standard boxes and bulk packs as shown below.

**Sold In:** Full box quantities only. Discount available for bulk box orders.

Length x Gauge	ZINC WITH SAND HEAD				ZINC WITH WHITE HEAD		ZINC WITH ZINC HEAD	
	Std Box Qty	Item #	Bulk Box Qty	Item #	Std Box Qty	Item #	Std Box Qty	Item #
2-1/2" x 10	500	WW37020	-	-	1,500	WW37015	1,500	WW37045
3" x 10	500	WW37060	1,000	WW37065	1,000	WW37055	500	WW37075

## BUGLE HEAD PHILLIPS DRIVE, TWINFAST THREAD Type 17 Auger Point



- Case hardened, Black
- Uses #2 Phillips Drive bits



**Packing:** Standard boxes and bulk packs as shown on right.

**Sold In:** Full box quantities only.

Discount available for bulk box orders.

Length x Gauge	BLACK FINISH			
	Std Box Qty	Item #	Bulk Box Qty	Item #
1-1/2" x 8	500	WL6B82500P	2,500	WL6B82500B



## OVERSIZED FLAT HEAD SQUARE DRIVE, COARSE THREAD With Nibs, Type 17 Auger Point

- Fastcap Power Head Screws for wood or metal studs
- Head diameter of 9/16" (.5625")
- Case hardened, zinc
- Uses #2 Square Drive bits

**Packing:** Standard box and bulk packs shown on right.

**Sold In:** Full box quantities only.

Discount available for bulk box orders.



### FOR WOOD STUDS

Length x Gauge	Finish	Std Box Qty		Bulk Box Qty	
		Item #		Item #	
1-1/8" x 10	Zinc	-	-	2,000	FAPHZ1-1/8-2000
1-1/4" x 10	Zinc	200	FAPHZ1-1/4-200	-	-
2-1/2" x 10	Zinc	150	FAPHZ2-1/2-150	1,500	FAPHZ2-1/2-1500
3" x 10	Zinc	150	FAPHZ3-150	-	-
3-1/2" x 10	Zinc	100	FAPHZ3-1/2-100	-	-
4" x 10	Zinc	100	FAPHZ4-100	-	-
2-1/2" x 10	Black	50	FAPHZ2-1/2-50BL	150	FAPHZ2-1/2-150BL
3" x 10	Black	50	FAPHZ3-50BL	150	FAPHZ3-150BL

### FOR METAL STUDS

Length x Gauge	Finish	Bulk Box Qty	
		Item #	
3" x 10	Zinc	1,500	FAPHZ3ME-1500

## FLAT HEAD AW® DRIVE, ASSY® THREAD With Nibs, Drill Tip & Shimming Feature



- Eliminates shimming when installing cabinets, windows.
- Once installed, simply rotate to adjust cabinet back and forth
- All screws are packaged with one AW® Drive Bit of the proper size
- Case hardened, zinc

**Packing:** Standard box quantities as shown on right.

**Sold In:** Full box quantities only.



### ZINC FINISH

Length x Gauge	Replacement Bit	Std Box Qty	
		Item #	
3-1/8" x 13	WWAW30	100	WW23446480

## TRIM-IT SCREWS, SQUARE DRIVE, TWINFAST THREAD Sharp Point



- Normally used for fastening trim moldings or jams
- Extremely small head (7/32") is hardly seen; can be countersunk and puttied over
- Type "A" point is very sharp and eliminates pre-drilling in most materials
- Case hardened, black
- #6 screws use #1 Square Drive bits; #8 screws use #2 Square Drive bits

**Packing:** Standard box quantities as shown on right.

**Sold In:** Full box quantities only.



### BLACK FINISH

Length x Gauge	Std Box Qty	
	Item #	
1-5/8" x 6	1,000	WW24010
2-1/4" x 6	1,000	WW24120
3" x 8	100	WW24200

## RUSTGUARD™ EXTERIOR GRADE SCREWS, PHILLIPS DRIVE, COARSE THREAD

With Nibs and Type 17 Auger Point



- Rustguard corrosion resistant coating provides maximum protection against rust and corrosion
- Dull gray finish that blends with most pressure treated lumber and many composite decking materials
- Successfully tested to exceed a 1800 hour salt spray test (ASTM B117)
- Superior to nails as they eliminate wood splitting, nail head pops and hammer marks
- Uses a #2 Phillips drive bit



**Packing & Sold In:** Full package quantities as shown below.

Item #	Length x Gauge	Finish	Pkg	Approx. Screw Count
SC158RG1	1-5/8" x 6	Dull Gray	1 lb. box	231
SC212RG1	2-1/2" x 8	Dull Gray	1 lb. box	109

## RUSTGUARD™ EXTERIOR GRADE SCREWS, SQUARE DRIVE, COARSE THREAD

With Nibs and Type 17 Auger Point



- Rustguard corrosion resistant coating provides maximum protection against rust and corrosion
- Dull gray finish that blends with most pressure treated lumber and many composite decking materials
- Successfully tested to exceed a 1800 hour salt spray test (ASTM B117)
- Superior to nails as they eliminate wood splitting, nail head pops and hammer marks
- Uses a #2 square drive bit



**Packing & Sold In:** Full package quantities as shown below.

Item #	Length x Gauge	Finish	Packaging	Approx. Screw Count
SC212SRG5	2-1/2" x 8	Dull Gray	5 pound box	545
SC212SDECPAK	2-1/2" x 8	Dull Gray	Bucket	1,000
SC3SRG5	3" x 9	Dull Gray	5 pound box	425
SC3SDECPAK	3" x 9	Dull Gray	Bucket	800

## COPPERGUARD™ EXTERIOR GRADE SCREWS, COMBO DRIVE, SERRATED THREAD

For use with ACQ™, With Nibs



- Copperguard™ (approved for use in ACQ™) organic polymer duplex coating system provides excellent corrosion protection in copper based pressure treated lumber.
- Patented Woodmaster® five-sided cutter thread design eliminates splitting and easily slices through the hardest materials.
- Averaged 2000+ hour's salt spray (tested in ACQ™ treated lumber).
- Tan finish.
- All use a #2 Square drive bit (SC112B2S).



**Packing & Sold In:** Full package quantities as shown below.

Item #	Length x Gauge	Finish	Pkg	Approx. Screw Count
SC2CGTAN5	2" x 7	Tan	5 lb. box	700
SC212CGTAN1	2-1/2" x 8	Tan	1 lb. box	113



## TRUSS HEAD PHILLIPS DRIVE, COARSE THREAD Type 17 Auger Point



- Large truss head reduces sinking of head in soft woods
- Type 17 Auger point is designed to prevent splitting in hardwoods when hardware is attached into or near the edge of material
- Uses #2 Phillips Drive bits
- Case hardened finishes listed below



**Packing:** Standard boxes of 1,000 and bulk packs as shown below.

**Sold In:** Full box quantities only. Discount available for bulk box orders.

Length x Gauge	ZINC FINISH				ANTIQUÉ ENGLISH FINISH			
	Std Box Qty Item #		Bulk Box Qty Item #		Std Box Qty Item #		Bulk Box Qty Item #	
5/8" x 8	1,000	WW58120	10,000	WW58130	1,000	WW59120	10,000	WW59130
3/4" x 8	1,000	WW58140	10,000	WW58150	-	-	-	-

## TRUSS HEAD RECEX (COMBO PHILLIPS & SQUARE) DRIVE COARSE THREAD



### Extra Long Type 17 Auger Point

- Features an extra long aggressive cutting point that cuts through the toughest materials
- Elongated cutting flute greatly reduces splitting and cracking
- Case hardened, Zinc
- Uses #2 Square Drive bits for insertion and #2 Phillips Drive bits for aftermarket adjustment



**Packing:** Standard boxes of 1,000 and bulk packs as shown on right.

**Sold In:** Full box quantities only.

Discount available for bulk box orders.

ZINC FINISH				
Length x Gauge	Std Box Qty Item #		Bulk Box Qty Item #	
3/4" x 8	1,000	WW59000	12,000	WW59050

## TRUSS HEAD COMBO PHILLIPS & SQUARE DRIVE, COARSE THREAD Regular Point



- Case hardened, finishes listed below
- Uses #2 Square Drive bits for insertion and #2 Phillips Drive bits for aftermarket adjustment

**Packing:** Standard boxes of 1,000 and bulk packs as shown below.

**Sold In:** Full box quantities only. Discount available for bulk box orders.



.303" DIAMETER HEAD					.366" DIAMETER HEAD				
Length x Gauge	ZINC FINISH		BLACK FINISH		Length x Gauge	ZINC FINISH			
	Std Box Qty Item #		Std Box Qty Item #			Std Box Qty Item #		Bulk Box Qty Item #	
7/16" x 8	1,000	WLTC57/16X8-2C	1,000	WLTC57/16X8-BL	7/16" x 8	1,000	WW44120	5,000	WW44125



## TRUSS HEAD PHILLIPS DRIVE, FINE THREAD Regular Point



- Case hardened, Zinc
  - Uses #2 Phillips Drive bits
- Packing:** Standard boxes of 1,000.  
**Sold In:** Full box quantities only.



ZINC FINISH		
Length x Gauge	Std Box Qty Item #	
1/2" x 7	1,000	BST1/2X7-2C

## LOW PROFILE TRUSS HEAD PHILLIPS DRIVE, COARSE THREAD Regular Point



- Low Truss Head screw for use on ball bearing slides such as KV® and Accuride®
- Available in Zinc, Black and White finishes
- Case hardened, finishes listed below
- Uses #2 Phillips Drive bits

**Packing:** Standard boxes and bulk packs as shown below.  
**Sold In:** Full box quantities only. Discount available for bulk box orders.



.303" Diameter Head



### .303" DIAMETER HEAD

#### ZINC FINISH

Length x Gauge	Std Box Qty Item #		Bulk Box Qty Item #	
7/16" x 8	1,000	WLTC7/16X8-2C	5,000	WLTC7/16X8-2C-M5



.366" Diameter Head

### .366" DIAMETER HEAD

#### ZINC FINISH

#### BLACK FINISH

#### WHITE FINISH

Length x Gauge	ZINC FINISH			BLACK FINISH		WHITE FINISH
	Std Box Qty Item #	Bulk Box Qty Item #	Bulk Box Qty Item #	Std Box Qty Item #	Bulk Box Qty Item #	Std Box Qty Item #
7/16" x 8	1,000 WW46000	5,000 WW46005	14,000 WW46010	1,000 WW46100	5,000 WW46150	1,000 WW46200

## MODIFIED TRUSS HEAD PHILLIPS DRIVE, COARSE THREAD Regular or Type 17 Auger Point



- Case hardened, finishes listed below
  - Uses #2 Phillips Drive bits
- Packing:** Standard and bulk boxes as shown below.  
**Sold In:** Full box quantities only.



Type 17 Auger Point



Regular Point

### TYPE 17 AUGER POINT

#### NICKEL FINISH

Length x Gauge	Std Box Qty Item #	
3/4" x 8	1,000	WW46300

### REGULAR POINT

#### ZINC FINISH

Length x Gauge	Std Box Qty Item #	Bulk Box Qty Item #
1/2" x 8	1,000 WW46750	5,000 WW46790

# SECTION P FASTENERS

# FLAT HEAD

## FLAT HEAD PHILLIPS DRIVE, FINE THREAD Sharp Point



- Steel woodscrews in short sizes for hinges, KD fittings, piano hinges and small assembly
- Holds in both hardwoods and softwoods
- #4 screws use #1 Phillips Drive bits, all others use #2 Phillips Drive bits
- Case hardened, finishes listed below



Flat Head

**Packing:** Standard and bulk pack quantities shown below.

**Sold In:** Full box quantities only. Discount available for bulk box orders.

BRIGHT BRASS FINISH			ANTIQUE ENGLISH FINISH			ZINC FINISH		
Length x Gauge	Std Pack Box Qty: 100 Item #	Bulk Pack Box Qty: 1,000 Item #	Std Pack Box Qty: 100 Item #	Bulk Pack Box Qty: 1,000 Item #	Length x Gauge	Std Pack Box Qty: 100 Item #	Bulk Pack Box Qty: 1,000 Item #	
1/2" x 4	WW40105	WW40100	-	-	1/2" x 4	-	WW40000	
1/2" x 5	WW40405	WW40400	WW40305	WW40300	1/2" x 5	WW40205	WW40200	
1/2" x 6	WW41175	WW41170	WW41010	WW41000	1/2" x 6	WW41110	WW41100	
5/8" x 4	-	-	-	WW40190	5/8" x 4	WW40185	WW40180	
5/8" x 5	WW40710	WW40700	WW40605	WW40600	5/8" x 5	WW40505	WW40500	
5/8" x 6	WW41315	WW41350	WW41310	WW41300	5/8" x 6	WW41210	WW41900	
3/4" x 5	WW40820	-	-	-	5/8" x 8	WW41810	WW41800	
<b>BLACK FINISH</b>						3/4" x 6	WW41410	WW41400
Length x Gauge	Std Pack Box Qty: 100 Item #	Bulk Pack Box Qty: 1,000 Item #				3/4" x 8	WW41955	WW41950
5/8" x 5	WW40615	WW40620				ZINC FINISH		
						Length x Gauge	Bulk Pack Box Qty: 30,000 Item #	Bulk Pack Box Qty: 38,000 Item #
						1/2" x 6	-	WW41150
						5/8" x 6	WW41200	-

## FLAT HEAD PHILLIPS DRIVE, COARSE THREAD Regular Point



- Case hardened, finishes listed below
- Uses #2 Phillips Drive bits



**Packing:** Standard box of 1,000 and bulk packs as shown below.

**Sold In:** Full box quantities only. Discount available for bulk box orders.

ZINC FINISH							NICKEL FINISH			
Length x Gauge	Std Box Qty Item #		Bulk Box Qty Item #		Bulk Box Qty Item #		Std Box Qty Item #		Bulk Box Qty Item #	
1/2" x 5	1,000	WW42075	5,000	WW42050	-	-	-	-	-	-
5/8" x 5	1,000	WW42080	5,000	WW42070	-	-	-	-	-	-
1/2" x 6	1,000	WW42100	5,000	WW42150	-	-	1,000	WW54200	5,000	WW54300
5/8" x 6	1,000	WW42300	5,000	WW42390	30,000	WW42400	1,000	WW54375	5,000	WW54380
3/4" x 6	1,000	WW42500	5,000	WW43150	-	-	1,000	WW54680	5,000	WW54690
1" x 6	1,000	WW38120	-	-	-	-	1,000	WW54900	-	-
5/8" x 7	1,000	WL9191	-	-	-	-	1,000	WW46800	-	-
3/4" x 7	-	-	-	-	-	-	1,000	WW43700	5,000	WW43750
1" x 7	-	-	-	-	-	-	1,000	WW54950	-	-

## FLAT HEAD PHILLIPS DRIVE, COARSE THREAD

Type 17 Auger Point



- Case hardened, Zinc
- Uses #2 Phillips Drive bits

**Packing:** Standard boxes of 1,000 and bulk packs as shown on right.

**Sold In:** Full box quantities only. Discount available for bulk box orders.



ZINC FINISH				
Length x Gauge	Std Box Qty		Bulk Box Qty	
	Item #		Item #	
5/8" x 6	1,000	WW43000	5,000	WW43020
3/4" x 6	1,000	WW43100	5,000	WW54765

## FLAT HEAD RECEX (COMBO PHILLIPS/SQUARE DRIVE), COARSE THREAD

Regular Point



- Case hardened, Zinc
- Uses #2 Phillips Drive bits for insertion and #2 Phillips Drive bits for aftermarket adjustment

**Packing:** Standard boxes of 1,000 and bulk packs as shown on right.

**Sold In:** Full box quantities only. Discount available for bulk box orders.



ZINC FINISH				
Length x Gauge	Std Box Qty		Bulk Box Qty	
	Item #		Item #	
1/2" x 6	1,000	WW39080	-	-
5/8" x 6	1,000	WW39090	15,000	WW39085

## FLAT HEAD PHILLIPS DRIVE, FINE THREAD

Sharp Point



- Steel woodscrews in short sizes for hinges, KD fittings, and small assembly
- Provides holding in both hardwoods and softwoods
- Case hardened, Zinc
- Uses #2 Phillips Drive bit

**Packing:** Standard boxes of 200.

**Sold In:** Full box quantities only.



ZINC FINISH		
Length x Gauge	Std Box Qty	Item #
7/16" x 7	200	BSF7/16X7-26-C2

## FLAT HEAD PHILLIPS DRIVE, COARSE THREAD

Sharp Point

NICKEL FINISH			
Head Type	Length x Gauge	Std Box Qty Item #	
Flat	1/2" x 6	500	GF81014
Flat	5/8" x 6	500	GF81001
Flat	3/4" x 6	500	GF81003
Flat	3/4" x 8	500	GF81005
Flat	1" x 6	500	GF81004
Round	3/4" x 10	500	GF81007

- Case hardened, Nickel
- Uses #2 Phillips Drive bits

**Packing:** Standard box quantities of 500.

**Sold In:** Full box quantities only.

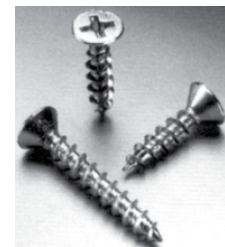

## FLAT HEAD PHILLIPS DRIVE, FINE THREAD

Sharp Point



- Sharp point screws are threaded bottom 2/3 of screw
- Regular point screws are fully threaded
- Case hardened, Zinc
- Uses #2 Phillips Drive bit

**Packing:** Standard boxes of 100.

**Sold In:** Full box quantities only.

Length x Gauge	Std Box Qty Item #		Length x Gauge	Std Box Qty Item #	
1" x 6	100	EO11020	2" x 8	100	EO11054
1-1/2" x 8	100	EO11050	2-1/2" x 8	100	EO11058
1-3/4" x 8	100	EO11052	2-1/2" x 10	100	EO11090



## UNDERCUT FLAT HEAD PHILLIPS DRIVE, COARSE THREAD Regular or Type 17 Auger Point



- Undercut head sits flush in the recessed hole of European drawer slides
- Case hardened, finishes listed below
- Uses #2 Phillips Drive bits

**Packing:** Standard boxes of 1,000 and bulk packs as shown below.

**Sold In:** Full box quantities only. Discount available for bulk box orders.



Regular Point

REGULAR POINT								
Length x Gauge	ZINC FINISH				BRIGHT BRASS FINISH		ANTIQUE ENGLISH FINISH	
	Std Box Qty Item #		Bulk Box Qty Item #		Std Box Qty Item #		Bulk Box Qty Item #	
1/2" x 6	1,000	WW43250	33,000	WW43255	-	-	-	-
5/8" x 6	1,000	WW43420	30,000	WW43440	1,000	WW43300	1,000	WW43350

TYPE 17 AUGER POINT						
Length x Gauge	ZINC FINISH				ANTIQUE ENGLISH FINISH	
	Std Box Qty Item #		Bulk Box Qty Item #		Std Box Qty Item #	
1/2" x 6	-	-	5,000	WLUCP1/2X6-2C-M5	-	-
5/8" x 6	1,000	WLUCP5/8X6-2C	30,000	WLUCP5/8X6-2C-M5	1,000	WLUCP5/8X6-AE



Type 17 Auger Point

## PAN HEAD PHILLIPS DRIVE, FINE THREAD Regular Point



- Steel woodscrews in short sizes for hinges, KD fittings and small assembly
- Holds in both hardwoods and softwoods
- Case hardened, finishes listed below
- Uses #2 Phillips Drive bits

**Packing:** Standard boxes of 1,000 and bulk packs as shown below.

**Sold In:** Full box quantities only. Discount available for bulk box orders.



Pan Head

Length x Gauge	ZINC FINISH		ANTIQUE ENGLISH FINISH		BLACK FINISH
	Std Pack Box Qty: 100 Item #	Bulk Pack Box Qty: 1,000 Item #	Std Pack Box Qty: 100 Item #	Bulk Pack Box Qty: 1,000 Item #	Std Pack Box Qty: 100 Item #
1/2" x 6	WW44030	WW44060	WW44000	WW44050	WW44005
1/2" x 7	WW44180	WW44190	-	-	-
1/2" x 8	WW44138	WW44130	-	-	-
5/8" x 6	-	WW44165	-	WW44090	-
5/8" x 8	WW44155	WW44160	-	-	-
3/4" x 6	-	WW44150	-	-	-





## PAN HEAD PHILLIPS DRIVE, COARSE THREAD

### Regular Point or Type 17 Auger Point

- Edge application screws are designed to prevent splitting in hardwoods when hardware is attached into or near the edge of the material
- Used with European style face frame hinges, pin and pivot hinges, or with catches and latches.
- Case hardened, finishes listed below
- Uses #2 Phillips Drive bits

**Packing:** Standard boxes of 1,000 and bulk packs as shown below.

**Sold In:** Full box quantities only. Discount available for bulk box orders.

REGULAR POINT				
NICKEL FINISH				
Length x Gauge	Std Box Qty Item #	Bulk Box Qty Item #		
5/8" x 10	1,000 WW45600	-	-	
3/4" x 10	1,000 WW45800	9,000	WW45700	
1" x 10	1,000 WW45810	-	-	



Regular Point

TYPE 17 AUGER POINT				
NICKEL FINISH				
Length x Gauge	Std Box Qty Item #	Bulk Box Qty Item #		
5/8" x 10	1,000 WW45630	-	-	
3/4" x 10	1,000 WW45820	9,000	WW45830	
1" x 10	1,000 WW45880	-	-	



Type 17 Auger Point

TYPE 17 AUGER POINT								
Length x Gauge	ANTIQUÉ ENGLISH FINISH				ZINC FINISH			
	Std Box Qty Item #	Bulk Box Qty Item #		Std Box Qty Item #	Bulk Box Qty Item #			
1/2" x 6	1,000 WW45220	30,000	WW45225	1,000 WW45230	-	-		
5/8" x 6	1,000 WW45330	5,000	WW45335	1,000 WW45340	-	-		
5/8" x 8	1,000 WW45540	-	-	1,000 WW45560	15,000	WW45570		
3/4" x 8	1,000 WW45640	-	-	1,000 WW46500	10,000	WW46520		



Type 17 Auger Point

## WASHER HEAD RESEX (COMBO PHILLIPS & SQUARE) DRIVE, COARSE THREAD

### Type 17 Auger Point

- Edge application screws are designed to prevent splitting in hardwoods when hardware is attached into or near the edge of the material. Used with European style face frame hinges, pin and pivot hinges, or with catches and latches
- Case hardened, finishes listed below
- Uses #2 Square Drive bits for for insertion and #2 Phillips Drive bits for aftermarket adjustment

**Packing:** Standard boxes of 1,000 and bulk packs as shown below.

**Sold In:** Full box quantities only. Discount available for bulk box orders.



Length x Gauge	LUBRICATED FINISH		ZINC FINISH			
	Std Box Qty Item #	Bulk Box Qty Item #		Std Box Qty Item #	Bulk Box Qty Item #	
3/4" x 8	1,000 WW39390	1,000	WW55500	10,000	WW55550	

# SECTION P FASTENERS

# PHILLIPS DRIVE

## ROUND HEAD PHILLIPS DRIVE, FINE THREAD

Youngdale Screw, Regular Point



- For installation of Youngdale hinges
- Case hardened, finishes listed on right
- Uses #2 Phillips Drive bits

**Packing:** Standard box of 1,000.

**Sold In:** Full box quantities only.

Length x Gauge	ANT. BRASS FINISH		BRIGHT BRASS FINISH		BRIGHT NICKEL FINISH		RUBBED BRONZE FINISH	
	Std Box Qty	Item #	Std Box Qty	Item #	Std Box Qty	Item #	Std Box Qty	Item #
1/2" x 6	1,000	YD612AB	1,000	YD612BP	1,000	YD612NP	1,000	YD612RB
5/8" x 6	1,000	YD658AB	1,000	YD658BP	1,000	YD658NP	1,000	YD658RB

## OVAL HEAD PHILLIPS DRIVE, FINE THREAD

Sharp Point



- Oval head countersinks like flat head and slightly rounded head provides a finished look
- Steel woodscrews in short sizes for hinges, KD fittings and small assembly
- Holds in both hardwoods and softwoods
- Case hardened, finishes listed below
- Uses #2 Phillips Drive bits

**Packing:** Standard boxes of 100 and bulk packs as shown below.

**Sold In:** Full box quantities only. Discount available for bulk box orders.



Length x Gauge	BRIGHT BRASS FINISH				ANTIQUENGLISH FINISH				ZINC FINISH	
	Std Box Qty	Item #	Bulk Box Qty	Item #	Std Box Qty	Item #	Bulk Box Qty	Item #	Bulk Box Qty	Item #
5/8" x 5	-	-	-	-	100	WW50085	1,000	WW50000	1,000	WW50050
5/8" x 6	100	WW50255	-	-	100	-	1,000	WW50200	-	-

## MODIFIED WASHER HEAD, PHILLIPS OR RECEX (COMBO PHILLIPS & SQUARE) DRIVE, COARSE THREAD

Type 17 Auger Drive, Drawer Front Adjusting Screw



- 1/2" diameter washer head screw
- Case hardened, Zinc
- Uses #2 Phillips or Square Drive bits

**Packing:** Mini and standard box quantities and bulk packs as shown below.

**Sold In:** Full box quantities only. Discount available for bulk box orders.

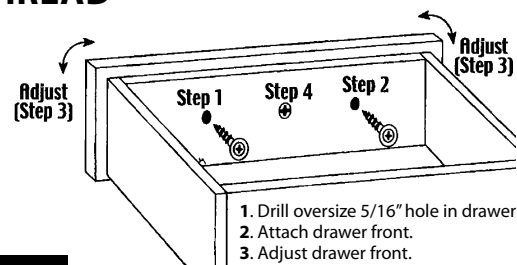

PHILLIPS DRIVE						
ZINC FINISH						
Length x Gauge	Mini Box Qty		Std Box Qty		Bulk Box Qty	
	Item #	Item #	Item #	Item #	Item #	Item #
1" x 8	100	WW80110	1,000	WW80330	7,000	WW80340
1-1/8" x 8	100	WW80510	1,000	WW80450	6,500	WW80760
1-1/4" x 8	100	WW81810	1,000	WW80750	6,500	WW80930
1-1/2" x 8	-	-	1,000	WW81010	-	-



Phillips Drive Type 17 Point

RECEX (COMBO PHILLIPS & SQUARE) DRIVE				
ZINC FINISH				
Length x Gauge	Std Box Qty		Bulk Box Qty	
	Item #	Item #	Item #	Item #
1" x 8	1,000	WW81200	7,000	WW81300
1-1/8" x 8	1,000	WW81500	6,500	WW81600
1-1/4" x 8	1,000	WW81800	6,500	WW81900



Recex Drive, Type 17 Auger Point



## FLAT HEAD, POZIDRIVE OR AW® DRIVE

7.2mm Head Diameter

- Case hardened, Nickel
- Packing:** Standard box quantities as shown.
- Sold In:** Full box quantities only.

#2 POZIDRIVE, NICKEL FINISH					
Length x Gauge	Std Box Qty Item #		Length x Gauge	Std Box Qty Item #	
7.5mm	1,000	WW59920	14.5mm	1,000	WW60300
10mm	1,000	WW60000	18mm	1,000	WW60350
11.5mm	1,000	WW60100	20mm	1,000	WW60420
13mm	1,000	WW60200	25mm	1,000	WW60520



Pozidrive

AW20 DRIVE, NICKEL FINISH			
Length x Gauge	Replacement Bit	Std Box Qty Item #	
11mm	WWAW20	500	WW27656311
14mm	WWAW20	500	WW27656314



AW Drive  
(One bit included in each box)

## FLAT HEAD, PHILLIPS OR SQUARE DRIVE

7.5mm Head Diameter

- Case hardened, Nickel
- Packing:** Standard boxes of 1,000.
- Sold In:** Full box quantities only.

### WURTH #2 PHILLIPS DRIVE, NICKEL FINISH

Length x Gauge	Std Box Qty Item #	
13mm	1,000	WW60260



#2 Phillips Drive



### GRASS #2 PHILLIPS DRIVE, NICKEL FINISH

Length x Gauge	Std Box Qty Item #	
7.5mm	1,000	GF83001K
13mm	1,000	GF81015K
18mm	1,000	GF83000K



#2 Phillips Drive

### WURTH #2 SQUARE DRIVE, NICKEL FINISH

Length x Gauge	Std Box Qty Item #	
13mm	1,000	WW60250



#2 Square Drive



## SHEET METAL SCREWS, FLAT HEAD PHILLIPS DRIVE

Regular Point

- Zinc finish
- Uses #2 Phillips Drive Bits
- Packing:** Standard boxes of 100.
- Sold In:** Full box quantities only.

ZINC FINISH					
Length x Gauge	Std Pack Item #		Length x Gauge	Std Pack Item #	
1" x 6	100	EO16245	2" x 8	100	EO16263
1-1/2" x 8	100	EO16261			

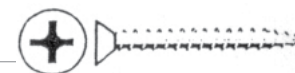

## SHEET METAL SCREWS, PAN HEAD PHILLIPS DRIVE

Regular Point

- Zinc finish
- Uses #2 Phillips Drive bit
- Packing:** Standard boxes of 100.
- Sold In:** Full box quantities only.

ZINC FINISH					
Length x Gauge	Std Pack Item #		Length x Gauge	Std Pack Item #	
1" x 6	100	EO15320	2" x 8	100	EO15345
1-1/2" x 10	100	EO15363	1" x 10	100	EO15361





## 8-32 THREAD MACHINE SCREWS

### Combo Phillips/Slotted Drive

- For use with 8-32 thread visual hardware
- For surface mounted knobs and pulls it is recommended that the screw length be 1/4" greater than the material thickness
- Zinc finish
- Uses #2 Phillips Drive bit

**Packing:** Standard boxes of 100 and bulk packs as shown below.

**Sold In:** Full box quantities only. Discount available for bulk box orders.



ZINC FINISH					
Length	Std Pack Box Qty: 100 Item #	Bulk Pack Box Qty: 1,000 Item #	Length	Std Pack Box Qty: 100 Item #	Bulk Pack Box Qty: 1,000 Item #
1/2"	-	WW47120	1-1/4"	WW47500	WW47520
5/8"	-	WW46950	1-3/8"	WW47600	WW47620
3/4"	-	WW47130	1-1/2"	WW47700	WW47720
7/8"	WW47200	WW47220	1-5/8"	WW47800	WW47820
1"	WW47300	WW47320	1-3/4"	WW47900	WW47920
1-1/8"	WW47400	WW47420	2"	WW48000	WW48020

## 8-32 THREAD (BREAKAWAY), MACHINE SCREWS

### Combo Phillips/Slotted Drive

- For use with 8-32 thread visual hardware
- 1-3/4" long with break-a-ways at 3/4", 1", 1-1/4" and 1-1/2"
- Zinc finish
- Uses #2 Phillips Drive bit

**Packing:** Standard and bulk quantity boxes shown on right.

**Sold In:** Full box quantities only.

Discount available for bulk box orders.



ZINC FINISH				
Length x Gauge	Std Box Qty	Item #	Bulk Box Qty	Item #
1-3/4"	100	WW48700	1,000	WW48720



## M4 THREAD MACHINE SCREWS

### Combo Phillips/Slotted Drive

- For use with M4 threaded visual hardware
- For surface mounted knobs and pulls it is recommended that the screw length be 6mm (1/4") greater than the material thickness
- Zinc finish
- Uses #2 Phillips Drive bit

**Packing:** Standard boxes of 100.

**Sold In:** Full box quantities only.



ZINC FINISH					
Length	Std Box Qty	Item #	Length	Std Box Qty	Item #
3/4" (20mm)	100	WW48320	1-1/2" (38mm)	100	WW48550
7/8" (22mm)	100	WW48340	1-5/8" (39mm)	100	WW48600
1" (25mm)	100	WW48400	1-3/4" (45mm)	100	WW48640
1-3/16" (30mm)	100	WW48450	2" (50mm)	100	WW48660
1-3/8" (35mm)	100	WW48500			





## M4 THREAD (BREAKAWAY), MACHINE SCREWS Combo Phillips/Slotted Drive

- For use with M4 threaded visual hardware
- 45mm long with break-a-ways at 19mm, 25mm, 32mm, and 38mm
- Zinc finish
- Uses #2 Phillips Drive bit

**Packing:** Standard boxes of 100.  
**Sold In:** Full box quantities only.

ZINC FINISH		
Length	Std Box Qty Item #	
1-3/4" (45mm)	100	WW48900



## WASHER HEAD PHILLIPS DRIVE, COARSE THREAD Fully Threaded

- For use with plastic/nylon handles
- For surface mounted knobs and pulls it is recommended that the screw length be 3/8" - 1/2" greater than the material thickness
- Zinc finish
- Uses #2 Phillips Drive bit

**Packing:** Standard boxes of 1,000.  
**Sold In:** Full box quantities only.

NICKEL FINISH		
Length x Gauge	Std Box Qty Item #	
1-1/4" x 8	1,000	WLCT8125
1-3/4" x 8	1,000	WLCT8175



## WASHER HEAD PHILLIPS/SLOT DRIVE, TYPE B THREAD Combo Phillips/Slotted Drive, Round Washerhead

- For use in wooden knobs without a brass insert
  - Zinc finish
  - Uses #2 Phillips Drive bit
- Packing:** Standard and bulk packs as shown on right.  
**Sold In:** Full box quantities only.  
Discount available for bulk box orders.

ZINC FINISH				
Length x Gauge	Std Box Qty Item #		Bulk Box Qty Item #	
1-1/4" x 12	100	WLCT12125-C	-	-
1-1/2" x 12	100	WLCT12150-C	-	-
1-3/4" x 12	100	WLCT12175-C	1,000	WLCT12175



## BREADBOARD SCREW

- 8-32 machine screw on one end and #6 x 5/8" wood screw on the other end
- Packing:** 25 screws per box.  
**Sold In:** Full box quantities only.

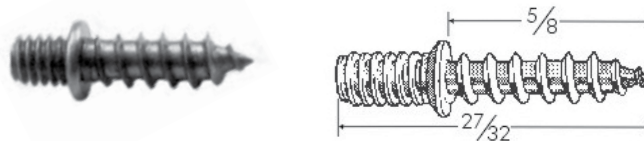

**Item#**

EPBB-100

## CONFIRMAT (DOWEL) SCREWS, FLAT HEAD WITH OR WITHOUT NIBS, BLUNT OR SHARP POINT PoziDrive



- Designed for use in case assembly
- Pilot hole diameter 5.4mm, shank diameter 7mm, and PoziDrive head diameter 10mm
- Zinc finish
- Uses #3 PoziDrive bits

**Packing:** Standard boxes of 500 and bulk packs as shown on right.

**Sold In:** Full box quantities only. Discount available for bulk box orders.



BLUNT POINT WITHOUT NIBS					
	Size	Std Box Qty Item #		Bulk Box Qty Item #	
A	7 x 50mm	500	WW70480	2,000	WW70450
SHARP POINT WITH NIBS					
	Size	Std Box Qty Item #		Bulk Box Qty Item #	
B	7 x 50mm	-	-	2,000	WW70410

## SYSTEM 1 FITTINGS FOR RIGID ASSEMBLY SYSTEMS SCREW Double Locking Carcase Screws



- Zinc diecast for precision
- Titus double locking carcase screw makes an almost invisible connection
- Collar under the head to pull panels together
- 2nd "lower" thread pulls against a "faster" thread to provide maximum connection force and prevents overdriving on fastener
- Almost invisible in position

**Packing:** Standard bag or box quantities as shown below.

**Sold In:** Full bag or box quantities only. Discount available for box quantity orders.

Item#	Size	Material	Finish	Bag Qty	Box Qty
TT0180-885	6mm x 42mm	Zinc	Zinc	100	2,000

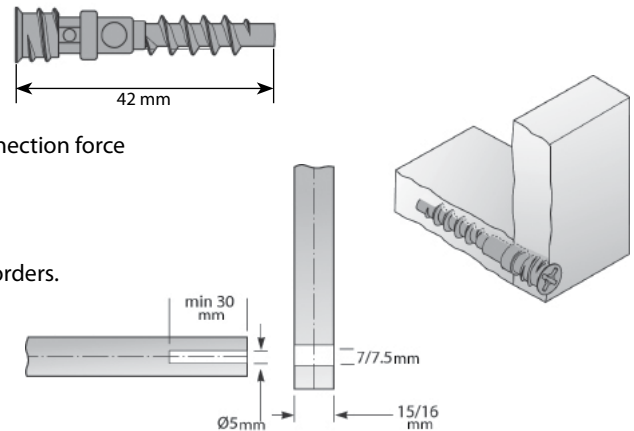

## SYSTEM 1 FITTINGS FOR RIGID ASSEMBLY SYSTEMS SCREW Hi-Lo™ Carcase Construction Screws



- The Hi-Lo™ carcase construction screw (CCS) offers a strong, tolerant and cost effective connection with minimal panel preparation
- "Hi" thread gives low bursting component force from the sharp 30 degree angle thread
- "Lo" thread at 60 degree angle uses the vertical force component to press fibrous and particle components of panels onto the "Hi" thread and are contained by their greater height
- The very small shank on a Hi-Lo™ screw means less material displacement than conventional threads

**Packing:** As shown below.

**Sold In:** Full box quantities only.

Item#	Screw Diameter	Drilling Depth	Total Length (L)	Material	Color	Box Qty
TT0071-852-L5	4mm	28mm	33mm	Steel	Black	250
TT6074-852-L5	4mm	33mm	38mm	Steel	Black	250
TT6077-852-L5	4mm	45mm	50mm	Steel	Black	250

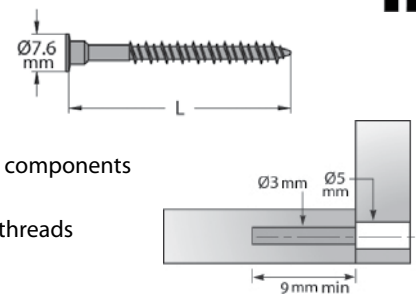



## CONNECTING SCREWS

### 5mm Bore - Metal

- Made of corrosion resistant steel
- Ribbed to prevent rotation while tightening
- 1 set = 1 male and 1 female

**Packing:** Standard boxes of 100 and bulk packs as shown below.

**Sold In:** Full box quantities only. Discount available for bulk box orders.

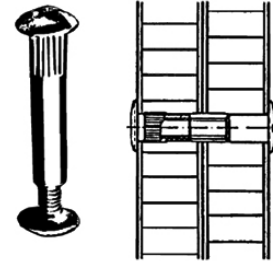

ZINC FINISH					
Made For Wood Thickness	Bore Size	Std Box Qty Item #		Bulk Box Qty Item #	
1-3/16" - 1-9/16"	5mm	100	KD565NP-27-C	500	KD565NP-27
1-3/8" - 1-11/16"	5mm	100	KD565NP-35-C	500	KD565NP-35

## CONNECTING SCREWS

### 8mm Bore - Plastic/Metal

- Plastic insert has plastic socket and screw head with galvanized steel threaded bolt
- Made of corrosion resistant steel
- Ribbed to prevent rotation while tightening
- 1 set = 1 male and 1 female

**Packing:** Standard boxes of 100 and bulk packs as shown below.

**Sold In:** Full box quantities only. Discount available for bulk box orders.



Made For Wood Thickness	Bore Size	Std Box Qty Item #		Bulk Box Qty Item #	
<b>WHITE FINISH (PLASTIC /METAL)</b>					
1-3/8" - 1-11/16"	8mm	100	KD7536WH-C	500	KD7536WH
<b>NICKEL FINISH (METAL)</b>					
1-3/16" - 1-9/16"	8mm	100	KD555NP-31-C	500	KD555NP-31
1-7/16" - 1-7/8"	8mm	100	KD555NP-37-C	500	KD555NP-37

## SCREW WAX

### Screw Lubricant

- Makes screwing into wood quieter, easier and faster; turn screws with less torque
- Great for cabinet installation
- Also works great on threading bolts, squeaky hinge pins, squeaky wheels and drill bit lubricant

**Packing & Sold In:** Each

Item #	Size
FASCREWWAX	8 oz.



## SLOTTED SCREW HEAD BITS

### Assorted Size Drive Bits

- Inserted directly into the front of a power driver / drill
- Should not be used with a bit holder

**Packing:** As shown on right.

**Sold In:** Full pack quantities only.



Item#	Brand	Fits Screw Size	Overall Length	Pack Qty
WL11785	Quickscrews	#5-#6	2"	10
BL27463	Bosch	#4-#5	1-5/16"	1
BL27464	Bosch	#5-#6	1-5/16"	1
BL27465	Bosch	#6-#7	1-5/16"	1
AP320-1	Apex	#4-#5	1-5/16"	1
AP320-2	Apex	#5-#6	1-5/16"	1
AP320-3	Apex	#6-#7	1-5/16"	1

## SLOTTED SCREW HEAD BITS

### Drive Bit With Finder Sleeve



- Finder sleeve makes it easier to engage slotted fasteners with the bit
- Guides the bits so there is less “searching” for the proper alignment between blade and slot
- Inserted directly into the front of a power driver / drill
- Should not be used with a bit holder

**Packing & Sold In:** Each

Item#	Brand	Fits Screw Size	Overall Length	Pack Qty
APP320	Apex	#8 - #10	3-3/4"	1

## PHILLIPS HEAD INSERT BITS

### Assorted Size Insert Bits

- Use in conjunction with bit holders
- Available in reduced shank for use when driving screws below the surface, typically in drywall applications

**Packing:** As shown on right.

**Sold In:** Full pack quantities only.



Item#	Brand	Fits Screw Size	Overall Length	Pack Qty
WW614176274	Wurth	#1	1"	1
WW614176461	Wurth	#2	1"	1
WW614176648	Wurth	#3	1"	1
WL11758	Quickscrews	#1	1"	10
WL11760	Quickscrews	#2	1"	10
WL11759	Quickscrews	#2 Reduced Shank	1"	10
WL11765	Quickscrews	#3	1"	10
BL27035	Bosch	#1 Reduced Shank	1"	1
BL27036	Bosch	#2 Reduced Shank	1"	1
APX440-1	Apex	#1	1"	1
APX446-1	Apex	#1 Reduced Shank	1"	1
APX440-2	Apex	#2	1"	1
APX446-2	Apex	#2 Reduced Shank	1"	1
APX440-3	Apex	#3	1"	1

## PHILLIPS HEAD INSERT BITS

### Insert Bits With Anti-Cam Out

- ACR bits are for use with painted, coated or corroded screws
- Use in conjunction with bit holders
- Available in reduced shank for use when driving screws below the surface, typically in drywall applications

**Packing:** As shown on right.

**Sold In:** Full pack quantities only.

Item#	Brand	Fits Screw Size	Overall Length	Pack Qty
WL12117	Quickscrews	#2 ACR	1"	10
WL12118	Quickscrews	#2 ACR Reduced Shank	1"	10



## PHILLIPS HEAD BITS Assorted Size Drive Bits

- Inserted directly into the front of a power driver/drill
- Should not be used with a bit holder

**Packing:** As shown on right.

**Sold In:** Full pack quantities only.



Item#	Brand	Fits Screw Size	Overall Length	Pack Qty
WL11972	Quickscrews	#1	3-1/2"	10
WL11905	Quickscrews	#2	1-5/16"	10
WL11761	Quickscrews	#2	2-3/4"	10
WL11762	Quickscrews	#2	3-1/2"	10
WL11908	Quickscrews	#3	3-1/2"	10
BL27360	Bosch	#1	1-15/16"	1
BL27366	Bosch	#1	3-1/2"	1
BL27361	Bosch	#2	1-15/16"	1
BL27367	Bosch	#2	3-1/2"	1
BLCCP3201	Bosch	#3	2"	1

## PHILLIPS HEAD BITS Assorted Size Magnetic Drive Bits

- Inserted directly into the front of a power driver / drill
- Should not be used with a bit holder

**Packing:** As shown on right.

**Sold In:** Full pack quantities only.



Item#	Brand	Fits Screw Size	Overall Length	Pack Qty
WL12690	Quickscrews	#2	1-5/16"	10
WL12691	Quickscrews	#2	2-3/4"	10
WL12692	Quickscrews	#2	3-1/2"	10
WL12694	Quickscrews	#2	6"	10
AP491A	Apex	#1	2-3/4"	1
AP491B	Apex	#1	3-1/2"	1
AP492	Apex	#2	1-5/16"	1
AP492A	Apex	#2	2-3/4"	1
AP492B	Apex	#2	3-1/2"	1

## POZIDRIVE INSERT BITS Assorted Size Insert Bits

- Pozi drive tips have an 8-bar pattern as opposed to the 4-bar pattern of a standard Phillips head. The extra bars provide higher torque with less slippage
- Use in conjunction with bit holders
- Available in reduced shank for use when driving screws below the surface, typically in drywall applications

**Packing:** As shown on right.

**Sold In:** Full pack quantities only.



Item#	Brand	Fits Screw Size	Overall Length	Pack Qty
WW614176651	Würth	#1	1"	1
WW614176652	Würth	#2	1"	1
WW614176653	Würth	#3	1"	1
WL11769	Quickscrews	#2	1"	10
WL11772	Quickscrews	#3	1"	10
APX446-2PZD	Apex	#2 Reduced Shank	1"	1

## POZIDRIVE BITS

### Assorted Size Drive Bits

- Pozi drive tips have an 8-bar pattern as opposed to the 4-bar pattern of a standard Phillips head. The extra bars provide higher torque with less slippage
- Inserted directly into the front of a power driver/drill
- Should not be used with a bit holder

**Packing:** As shown on right.

**Sold In:** Full pack quantities only.



Item#	Brand	Fits Screw Size	Overall Length	Pack Qty
WL11771	Quickscrews	#2	3-1/2"	10
BL27384	Bosch	#2	2-3/4"	1
BL27387	Bosch	#2	3-1/2"	1
AP492A-PZD	Apex	#2	2-3/4"	1

## PAINTED SQUARE DRIVE BITS

### Assorted Size Insert and Drive Bits

- Painted bits make it easy to identify the right bit (tip is not painted)
- Insert bits (1" overall length) are used in conjunction with a bit holder
- Drive bits (2" overall length and longer) are inserted directly into the front of a power driver/drill and should not be used with a bit holder
- Available in 1" to 6" overall length

**Packing:** 10 each per pack.

**Sold In:** Full pack quantities only.

Item #	Brand	Color	Fits Screw Size	Overall Length	Pack Qty
WW91130	Würth	Green	#1	3"	10
WW91140	Würth	Green	#1	4"	10
WW91210	Würth	Red	#2	1"	10
WW91220	Würth	Red	#2	2"	10
WW91230	Würth	Red	#2	3"	10
WW91240	Würth	Red	#2	4"	10
WW91260	Würth	Red	#2	6"	10



## SQUARE DRIVE INSERT BITS

### Assorted Size Insert Bits

- Use in conjunction with a bit holder.

**Packing:** As shown on right.

**Sold In:** Full pack quantities only.



Item#	Brand	Fits Screw Size	Overall Length	Pack Qty
WW90110	Würth	#1	1"	1
WW90210	Würth	#2	1"	1
WL11774	Quickscrews	#1	1"	10
WL11778	Quickscrews	#2	1"	10
BL29049	Bosch	#1	1"	1
BL29050	Bosch	#2	1"	1
AP950-1	Apex	#1	1"	1
AP950-2	Apex	#2	2"	1

## SQUARE DRIVE BITS Assorted Size Drive Bits

- Inserted directly into the front of a power driver/drill
- Should not be used with a bit holder
- Available in 1-5/16" to 6" overall length

**Packing:** As shown on right.

**Sold In:** Full pack quantities only.



Item#	Brand	Fits Screw Size	Overall Length	Pack Qty
WW90120	Würth	#1	2"	1
WW90130	Würth	#1	3"	1
WW90220	Würth	#2	2"	1
WW90230	Würth	#2	3"	1
WW90240	Würth	#2	4"	1
WW90260	Würth	#2	6"	1
WL11913	Quickscrews	#1	2-3/4"	10
WL11779	Quickscrews	#2	1-5/16"	10
WL11782	Quickscrews	#2	6"	10
BL29052	Bosch	#1	1-15/16"	1
BL29055	Bosch	#1	2-3/4"	1
AP954-1	Apex	#1	1-5/16"	1
AP954-2	Apex	#2	1-15/16"	1
AP954A-2	Apex	#2	2-3/4"	1
AP954C-2	Apex	#2	6"	1

## SQUARE DRIVE BITS Assorted Size Magnetic Drive Bits

- Inserted directly into the front of a power driver/drill
- Should not be used with a bit holder

**Packing:** As shown on right.

**Sold In:** Full pack quantities only.



Item#	Brand	Fits Screw Size	Overall Length	Pack Qty
WL12695	Quickscrews	#2	1-5/16"	10
WL12696	Quickscrews	#2	2-3/4"	10
WL12697	Quickscrews	#2	3-1/2"	10
WL12698	Quickscrews	#2	6"	10

## AW® ASSY DRIVE INSERT BITS Assorted Size Insert Bits

- AW drive is a patented design that provides the most torque and least amount of slippage available
- Use in conjunction with bit holders

**Packing & Sold In:** Each

Item#	Brand	Fits Screw Size	Overall Length
WWAW10	Würth	#10 Purple	1"
WWAW20	Würth	#20 Orange	1"
WWAW25	Würth	#25 Green	1"
WWAW30	Würth	#30 Yellow	1"

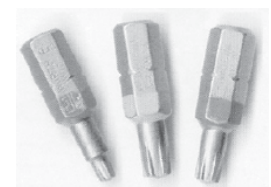

## AW® DRIVE BITS

### Assorted Length Drive Bits

- AW drive is a patented design that provides the most torque and least amount of slippage available
- Should not be used with a bit holder

**Packing & Sold In:** Each

Item#	Brand	Fits Screw Size	Overall Length
WWAW20-2	Würth	#20 Orange	2"
WWAW20-4	Würth	#20 Orange	4"
WWAW20-6	Würth	#20 Orange	6"



## AW® DRIVE BIT SET

### 9 Piece Kit

- 9 piece kit includes 3 each: AW10, AW20, and AW25 Drive Bits for ASSY screws
- Includes impact resistant case with space for one universal bit holder (not included)

**Packing & Sold In:** Each

**Item#**

WW61425022

**NEW  
ITEM!**

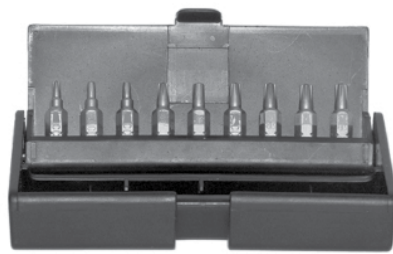

## DRIVE BIT SET W/MAGNETIC HOLDER

### 10 Piece Kit

Includes the following 1" bits:

- #1, #2, #3 Phillips drive
- #2 reduced Phillips drive
- #1, #2, #3 POZIDRIV®
- #1 and #2 square drive
- 2" long, 1/4" hex shank, quick release magnetic bit holder
- Nested plastic storage kit

**Packing & Sold In:** Each

**Item#**

WL11795

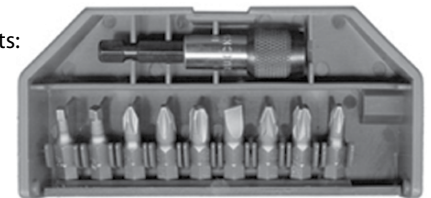

**NEW  
ITEM!**

## BIT MAGNET

- The perfect combination of polarity, strength and shape
- Slide over the base of a 1" insert bit, 6" extended bit, or anything in between and the magnetic transfer picks up multiple screws with ease

**Packing & Sold In:** Each

**Item#**

FATIPMAG

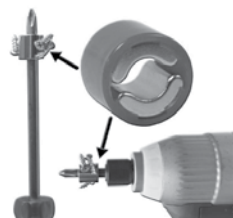

## RIGHT ANGLE DRILL ATTACHMENT, MAGNETIC 1/4" BIT MOUNT WITH QUICK CHANGE

- Suitable for use with electric drills and battery operated driver drills
- Specially hardened steel enables maximum torque, with a maximum speed of 2,000 RPM's
- Secure hold and 360° step-free adjustable handle
- Compact design is perfectly suited for screwing in cramped and hard-to-reach places
- Suitable for all standard bits

**Packing & Sold In:** Each

**Item#**

WW6149000



## QUICK CHANGE KEYLESS CHUCKS

- 1/4" hex shank, fits all keyed and keyless chucks. 3/8" shaft with 3 flats
- Maximum rpm: 2500

**Packing & Sold In:** Each

**Item#**

IB80032



## INSTY-DRIVE KEYED CHUCKS

- Adapters can be used with the Insty-Drive System (IB87808)
- 1/4 hex power bit shaft, maximum rpm: 2500

**Packing & Sold In:** Each

Item#	Size	Item#	Size
IB83308	1/8"	IB83311	11/64"
IB83309	9/64"	IB83312	3/16"

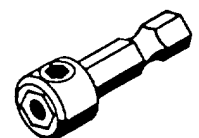



## INSERT BIT HOLDER, NON-MAGNETIC C-Ring 2 Piece Bit Holder

**Packing:** As shown below.

**Sold In:** Full packs only.



**BOSCH**



Item#	Overall Length	Pack Qty
WL11794	3"	5
WL11924	6"	5
BL27750	6"	1

## INSERT BIT HOLDER, SUPER MAGNETIC

**Packing:** As shown below.

**Sold In:** Full packs only.



Item#	Overall Length	Pack Qty
WL11928	2-3/8"	5

## INSERT BIT HOLDER, NON-MAGNETIC Taperlock Quick Release Bit Holder

- Attaches to any drill or impact gun; the harder you pull - the tighter it gets
- Unique patented Tapered spindle firmly holds any bit in place
- Pull out on the red collar while grabbing the bit and the TaperLock releases; push the bit in and slide the red collar towards the drill and the TaperLock is locked
- Works with any bit - the TaperLock works great with bits that don't have indents, notches or grooves; it also works with C6.3 & E6.3 bits

**Packing & Sold In:** Each

Item#	Overall Length
FATAPERLOCK	3"



## INSERT BIT HOLDER, MAGNETIC

- Bit holder allows for a variety of insert bits to be used in power tool applications
- High energy magnet helps alleviate the problem of lost bits

**Packing & Sold In:** Each

Item#	Brand	Overall Length
APM490-2	Apex	2"
BL40831	Bosch	2-1/8"
APM490	Apex	2-31/32"
WW614176702	Wurth	3"
WW99005	Wurth	3"
APM490-6	Apex	6"

**APEX**

**BOSCH**

**WÜRTH**

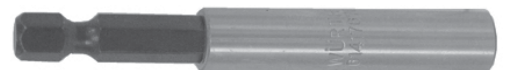

## INSERT BIT HOLDER, NON-MAGNETIC

With Quick Change Chuck



- Non-magnetic holders for screw-driving in metals
- Quick-Change mechanism provides a firm connection between the holder and the bit
- Slight forward motion of the locking sleeve unlocks the bit for a quick change

**Packing & Sold In:** Each



Item#	Overall Length
WW614176711	2"

## INSERT BIT HOLDER, MAGNETIC

With Quick Change Chuck



- A slight forward motion of the locking sleeve unlocks the bit for a quick change

**Packing:** As shown below.

**Sold In:** Full box quantities only.



Item#	Overall Length	Box Qty
WW99010	2-1/4"	1
WW614176708	3"	1
WL11922	3"	5
APQRM490A	3"	1
BL48802	2-1/32"	1

## INSERT BIT HOLDER, MAGNETIC

One Touch Release



- With a soft push on the button, the bit will shoot forward due to the internal spring and position itself for easy removal
- Tested to 60n torque
- Extra strong magnet holds the screw in place
- The One Touch Bit Holder can be operated with gloves
- Packed in clear PVC box for safe storage
- Stainless steel housing

**Packing & Sold In:** Each



**NEW  
ITEM!**

Item#
WW614176638



## SCREW COVERCAPS, PLASTIC Peel & Stick Covercaps For Any Drive Type

- PVC cover caps come in two diameter sizes; 9/16" and 11/16"
- PSA adhesive backed cover caps, adhesive strength increases as it cures
- Available in multi color sample boxes:
  - **FA916PVC** PVC Sampler includes 40 PVC sheets: 1 sheet of each solid, woodgrain and metal colors

**Packing:** As shown below.

**Sold In:** Full box quantities only.

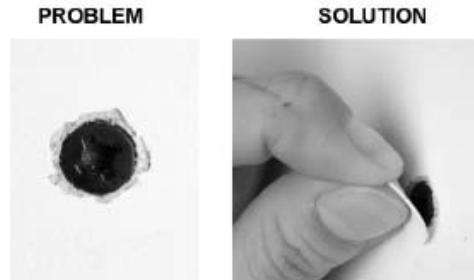

Material	Color/Style	Diameter	Color/Species	Std Box Qty	Item#	Bulk Box Qty	Item#
PVC	Solid Color	9/16"	Almond	260	FAP916AL25	1,040	FAP916AL
PVC	Solid Color	9/16"	Antique White	260	FAP916AW25	1,040	FAP916AW
PVC	Solid Color	9/16"	Black	260	FAP916BL25	1,040	FAP916BL
PVC	Solid Color	11/16"	Black	720	FAP1116BL	-	-
PVC	Solid Color	9/16"	Fog Gray	260	FAP916DG25	1,040	FAP916DG
PVC	Solid Color	9/16"	Folkstone	260	FAP916LG25	1,040	FAP916LG
PVC	Solid Color	11/16"	Folkstone	720	FAP1116LG	-	-
PVC	Solid Color	9/16"	White	260	FAP916WH25	1,040	FAP916WH
PVC	Solid Color	11/16"	White	720	FAP1116WH	-	-
PVC	Woodgrain	9/16"	Beech	-	-	1,040	FAP916BE
PVC	Woodgrain	9/16"	Candlelight	-	-	1,000	FAP916CL
PVC	Woodgrain	9/16"	Clear Maple	260	FAP916CM25	-	-
PVC	Woodgrain	9/16"	Chocolate Pear	-	-	1,000	FAP916CP
PVC	Woodgrain	9/16"	Cognac	-	-	1,000	FAP916CO
PVC	Woodgrain	9/16"	Dark Mahogany	260	FAP916DM25	-	-
PVC	Woodgrain	9/16"	Golden Oak	260	FAP916GO25	1,040	FAP916GO
PVC	Woodgrain	9/16"	Hardrock Maple	260	FAP916HM25	1,040	FAP916HM
PVC	Woodgrain	11/16"	Hardrock Maple	720	FAP1116HM	-	-
PVC	Woodgrain	9/16"	June Mahogany	-	-	1,000	FAP916JM
PVC	Woodgrain	9/16"	Knotty Pine	260	FAP916KP25	-	-
PVC	Woodgrain	9/16"	Light Maple	260	FAP916LM25	-	-
PVC	Woodgrain	9/16"	Light Oak	260	FAP916LO25	-	-
PVC	Woodgrain	9/16"	Manitoba Maple	260	FAP916MM25	1,040	FAP916MM
PVC	Woodgrain	9/16"	Medium Cherry	260	FAP916MC25	1,040	FAP916MC
PVC	Woodgrain	9/16"	Natural Cherry	260	FAP916NC25	1,040	FAP916NC
PVC	Woodgrain	11/16"	Natural Cherry	720	FAP1116NC	-	-
PVC	Woodgrain	9/16"	Natural Oak	260	FAP916NO25	1,040	FAP916NO
PVC	Woodgrain	9/16"	Presidential Walnut	260	FAP916PW25	1,040	FAP916PW
PVC	Woodgrain	9/16"	Red Mahogany	-	-	1,040	FAP916RDM
PVC	Woodgrain	9/16"	Riviera Maple	-	-	1,000	FAP916RM
PVC	Woodgrain	9/16"	Select Cherry	260	FAP916SC25	-	-
PVC	Woodgrain	9/16"	Summerflame	-	-	1,000	FAP916SF

## SCREW COVERCAPS, REAL WOOD

### Peel & Stick Covercaps For Any Drive Type



- Two diameters available; 9/16" and 11/16"
- Available in unfinished and finished wood species
- PSA adhesive on back of each cover cap, increases in strength as it cures
- Unfinished wood caps can be sanded, stained and finished
- Prefinished real wood cover caps are finished with clear, non-yellowing laquer
- Available in multi color sample boxes:
  - **FAAW916N** Unfinished Wood Sampler includes 16 sheets: 1 of each solid wood colors.
  - **FAPW916N** Prefinished Wood Sampler includes 12 sheets: 1 of each prefinished real wood caps.

**Packing:** As shown below.

**Sold In:** Full box quantities only.

Material	Style	Diameter	Species	Std Box Qty	Item#	Bulk Box Qty	Item#
Real Wood	Prefinished Woodgrain	9/16"	Birch	260	FAPW916B25	1,040	FAPW916B
Real Wood	Prefinished Woodgrain	9/16"	Maple	260	FAPW916M25	1,040	FAPW916MP
Real Wood	Prefinished Woodgrain	9/16"	Red Oak	260	FAPW916RO25	-	-
Real Wood	Unfinished Woodgrain	9/16"	Alder	260	FAW916AD25	-	-
Real Wood	Unfinished Woodgrain	9/16"	Cherry	260	FAW916CH25	1,040	FAW916CH
Real Wood	Unfinished Woodgrain	9/16"	Maple	260	FAW916MP25	1,040	FAW916MP
Real Wood	Unfinished Woodgrain	11/16"	Maple	-	-	720	FAW1116MP
Real Wood	Unfinished Woodgrain	9/16"	Natural Birch	260	FAW916NB25	1,040	FAW916NB
Real Wood	Unfinished Woodgrain	9/16"	Pine	260	FAW916PN25	-	-
Real Wood	Unfinished Woodgrain	9/16"	Red Oak	260	FAW916RO25	1,040	FAW916RO
Real Wood	Unfinished Woodgrain	9/16"	Walnut	260	FAW916WA25	-	-
Real Wood	Unfinished Woodgrain	9/16"	White Birch	260	FAW916WB25	-	-



## MICRO FLUSHMOUNT DRILL BIT SYSTEM

### For Fastcap Covercaps



- Unique ball bearing stop collar that controls the recess depth the drill creates and allows the stop collar to stop spinning when it comes in contact with the surface you are drilling
- Both pilot bit (1/8") and countersink bit (9/16") are adjustable
- 9/16" countersink allows you to perfectly flush screws and covercaps
- Micro adjust locking thumb screw
- Recommended FastCap accessory

**Packing & Sold In:** Each

Item#	Description
FAFCBCB9/16	Flushmount Bit, 9/16"
FAFCINNERBIT	Replacement Inner Bit

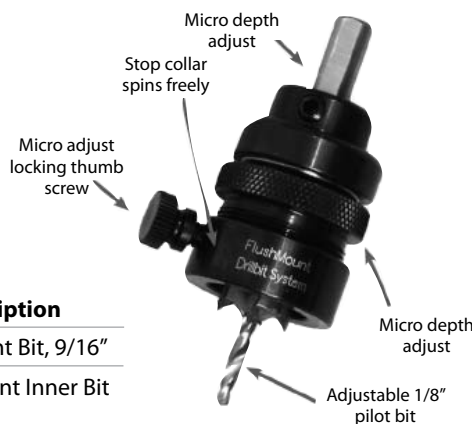

## CUSTOM COLOR COVERCAPS TOOL

- Punch your own custom color Fastcap covercaps
- For use punching .018 to .022 thick edgebanding and veneer
- Not recommended to use punching plastic laminate
- **FAPUNCHSINGLE** includes: carrying case, 3/8", 9/16", 11/16" diameter dies; hole punch tool; sample of 3" wood and metal PowerHead screws; 50' 1" SpeedTape
- **FAPUNCHSET** includes all of the above plus the FlushMount drill bit
- **FAHPRAFIX1** punches covercaps for use with Hafele "Rafix" housings

**Packing & Sold In:** Each



Item#	Description
FAPUNCHSET	Punch/Drill Kit
FAPUNCHSINGLE	Punch Kit
FAHPRAFIX1	Rafix 1 Die and Anvil
FAHOLEPUNCHEJECTOR	Laminate Covercap Ejector

## SCREW COVERCAPS, PLASTIC

For Phillips Drive Screws

- Knock in cover caps for #6 & #8 screws
- Packing:** Standard boxes of 200 and bulk packs as shown on right.
- Sold In:** Full box quantities only. Discount available for bulk box orders.

Color	Std Box Qty		Bulk Box Qty	
	Item #		Item #	
Almond	200	TT1020ALM-C2	1,000	TT1020ALM
Black	-	-	1,000	TT1020BLK
Dark Brown	-	-	1,000	TT1020DBRN
Light Brown	-	-	1,000	TT1020LBRN
Gray	200	TT1020GRY-C2	1,000	TT1020GRY
White	200	TT1020WH-C2	1,000	TT1020WH

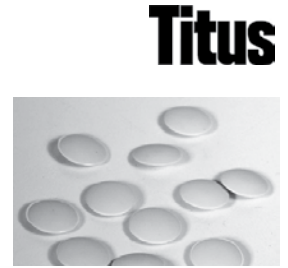

## SCREW COVERCAPS, PLASTIC

For Würth AW & Torx Drive Screws



- Specifically designed for insertion into the head of Würth AW®20 Drive Systems and Torx screws
- Packing:** As shown on right.
- Sold In:** Full box quantities only.



Item#	Color	Box Qty
WW590720101	White	500
WW590720105	Lt Ivory	500
WW590720108	Lt Brown	500
WW590720112	Black	500

## SCREW COVERCAPS, PLASTIC

For Any Drive Type



- 9/16" diameter cap fits flat head screw sizes 6 through 10
- Install screw and then snap cover over
- Packing:** Standard boxes of 100 and bulk packs as shown on right.
- Sold In:** Full box quantities only. Discount available for bulk box orders

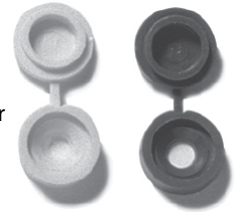

Color	Std Box Qty		Bulk Box Qty	
	Item #		Item #	
Almond	100	PGH210A-C	1,000	PGH210A
Black	100	PGH210BL-C	1,000	PGH210BL
Brown	100	PGH210BN-C	1,000	PGH210BN
White	100	PGH210WH-C	1,000	PGH210WH

## FINISHING WASHER



- Provides a clean, finished look for flat head screws
- Packing:** As shown below.
- Sold In:** Full box quantities only.



Item#	Brand	Material	Fits Screw Size	Finish	Box Qty
WW49000	Würth	Steel	#6	Black	1,000
WW49025	Würth	Steel	#6	Nickel	1,000
WW49175	Würth	Steel	#8	Black	1,000
WW49125	Würth	Steel	#8	Nickel	1,000
WW49325	Würth	Steel	#10	Black	1,000
WW49400	Würth	Steel	#10	Nickel	1,000

## FINISHING WASHER

Wood Washer



- Works with #6 and #8 bugle, flat or countersunk screws
- Designed with a 1" head diameter and a recess that allows your screw to sit flush in the washer
- Gives the extra holding power that you would normally only get with a fender washer
- Packing:** As shown below.
- Sold In:** Full pack quantities only.

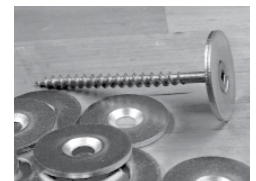

Item#	Pack Qty
FAWOODWASHER-10	10 Washers
FAWOODWASHER-30	30 Washers
FAWOODWASHER	50 Washers



## COVERCAPS FOR PLUMBING HOLES Self-Adhesive PVC



- Cover caps have adhesive backing
- Designed to trim cutouts for 1/2", 1-1/2" and 2" diameter plumbing lines
- Material is .020" thick PVC

### Packing:

**FAPP1WH5:** contains ten 1/2" diameter supply line cover caps and five 1-1/2" diameter waste line cover caps

**FAPP3WH5:** contains five 1/2" diameter supply line, cover caps and five 2" diameter waste line cover caps.

**Sold In:** Full box quantities only.

Item#	Material	Color
FAPP1WH5	PVC	White
FAPP3WH5	PVC	White

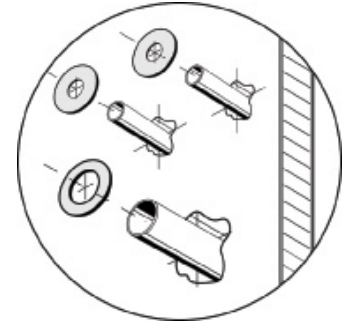

## COVERCAPS FOR 35MM HINGES Self-Adhesive PVC



- Designed to cover unused or misplaced holes bored in doors for European hinges
- Covercap measures 1-9/16" Wide by 2-1/2" Long
- Material is .020" thick PVC

**Packing:** Box contains 30 covercaps.

**Sold In:** Full box quantities only.

Item#	Material	Color
FAPH25WH5	PVC	White

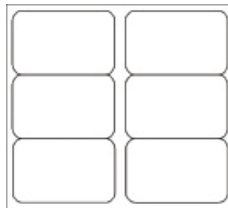

## ELECTRICAL BOX TRIM Self-Adhesive PVC



- Overall size: 4-1/8" wide x 5-9/16" high
- Designed to trim the cutout for a standard size (2-1/4" wide x 3-3/4" high) plastic electrical box

**Packing:** Contains (1) electrical box trim ring and (23) 9/16" diameter white Fastcap cover caps.

**Sold In:** Full box quantities only.

Item#	Material	Color
FAPE1WH5	PVC	White

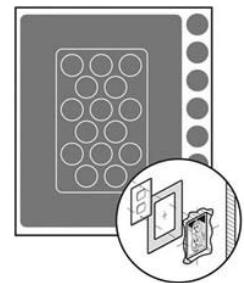

## COVERCAPS FOR POCKET CUTTER HOLES Plastic



- Push in plastic cover caps to hide and add a finishing touch to the mortised slot made by Porter Cable or Castle pocket cutting machines
- Overall sizes 2-3/8" L x 7/16" W
- Inserts into bore hole size of 1-3/8" long x 3/8" wide

**Packing:** As shown below.

**Sold In:** Full box quantities only.

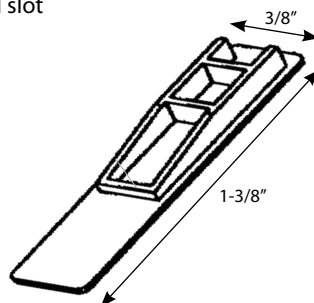

Color	Std Box Qty	Item #
Almond	100	PL1923AL
Black	100	PL1923BK
Brown	100	PL1923BN
Gray	100	PL1923GY
White	100	PL1923WH

## COVERCAPS FOR POCKET CUTTER HOLES Self-Adhesive PVC



- Designed for covering holes bored by pocket hole cutters
- Overall size: 2-1/2" long x 9/16" wide

**Packing:** 320 cover caps per box.

**Sold In:** Full box quantities only.

Item#	Material	Color
FAP91625HM	PVC	Maple
FAP91625WH	PVC	White
FAW91625MP	Wood Veneer	Unfinished Maple

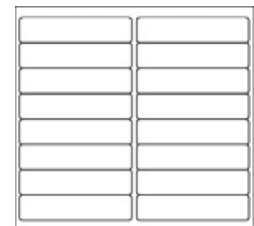



## SCREWHOLE PLUGS

### Real Wood Plugs

• Plugs are available in three head types: flathead, mushroom head and round head

• Plug diameters of 3/8", 1/2", 3/4" and 1"

**Packing:** As shown below.

**Sold In:** Full box quantities only.



Flat Head

Mushroom Head

Round Head

Species	Hole Size	Std Box Qty Item #	Bulk Box Qty Item #
<b>FLAT HEAD SCREWHOLE PLUGS</b>			
Birch	3/8"	500 SB38FP-B-L5	1,000 SB38FP-B
Cherry	3/8"	100 SB38FP-C-C	-
Oak	3/8"	500 SB38FP-O-L5	1,000 SB38FP-O
Oak	1/2"	500 SB12FP-O-L5	1,000 SB12FP-O
Walnut	3/8"	100 SB38FP-W-C	-

Species	Hole Size	Std Box Qty Item #	Bulk Box Qty Item #
<b>ROUND HEAD SCREWHOLE PLUGS</b>			
Birch	3/8"	500 SB38RP-B-L5	1,000 SB38RP-B
Birch	1/2"	500 SB12RP-B-L5	1,000 SB12RP-B
Cherry	3/8"	100 SB38RP-C-C	-
Oak	3/8"	500 SB38RP-O-L5	1,000 SB38RP-O
Oak	1/2"	500 SB12RP-O-L5	1,000 SB12RP-O

Species	Hole Size	Std Box Qty Item #	Bulk Box Qty Item #
<b>MUSHROOM HEAD SCREWHOLE PLUGS</b>			
Birch	3/8"	500 SB38B-B-L5	1,000 SB38B-B
Birch	3/4"	100 SB34B-B-C	-
Birch	1/2"	500 SB12B-B-L5	1,000 SB12B-B
Birch	1"	100 SB10B-B-C	-
Cherry	3/8"	100 SB38B-C-C	-
Cherry	1/2"	100 SB12B-C-C	-
Oak	3/8"	500 SB38B-O-L5	1,000 SB38B-O
Oak	1/2"	500 SB12B-O-L5	1,000 SB12B-O

## KOLBE KORNER DRAWER FRONT MOUNTING BRACKETS

### Metal & Plastic



- Gives you the ability to adjust drawer fronts horizontally and vertically, no need for drawer front adjusters
- Constructed of metal (heavy duty) or plastic (light duty)
- Quick and easy mounting of shaker and other style drawer fronts
- Screws and covercaps sold separately

**Packing:** Metal are 50 per box (screws and cover caps sold separately); Plastic are 50 per box and include screws and covers.

**Sold In:** Full box quantities only.

Item#	Description	Box Qty
FAKK50M-WH	Metal, White	50
FAKK50M-TAN	Metal, Tan	50
FAKK50BL	Plastic, Black	50
FAKK50CM	Plastic, Clear Maple	50
FAKK50LM	Plastic, Light Maple	50
FAKK50WH	Plastic, White	50
FAKK50MS-TAN	Screw/Cap Tan (for metal Kolbe Korner)	200
FAKK50MS-WH	Screw/Cap White (for metal Kolbe Korner)	200

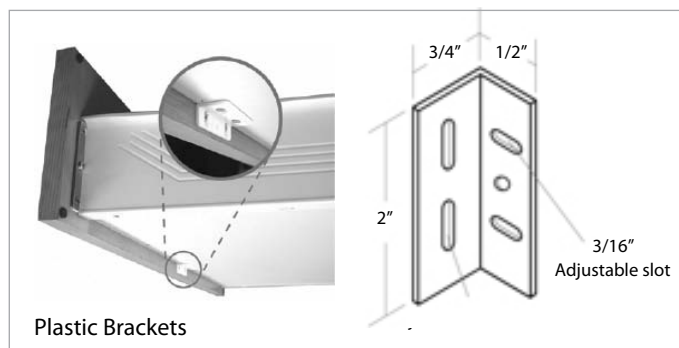
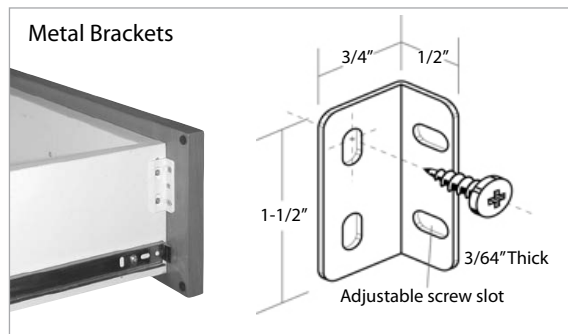

## MIRROR CLIPS

Plastic

- Use to attach mirrors to walls or cabinets
- Clear for use against any color
- Screws included

**Packing:** As shown to the right.

**Sold In:** Full box quantities only.

Item#	For Material Thickness	Color	Box Qty
KV6094PLAS	1/8"	Clear	100
KV6092PLAS	1/4"	Clear	100



## MIRROR CLIPS

Metal

- Glass Clip
- Use to attach mirrors to walls or cabinets
- 1/2" wide

**Packing:** As shown below.

**Sold In:** Both broken and full box quantities.

Discount available for full box orders.



Item#	For Material Thickness	Color	Box Qty
KV288ANO	1/4"	Anochrome	100

## TABLE GANGING CLAMPS

- Use to temporarily or permanently hold together groups of school, training, industrial or conference tables
- Works entirely by hand - no tools required
- Leaves no exposed hardware on the bottom of the table or the table edges
- Completely removable when not being used
- 2" wide x 1 3/8" deep, adjusts from 2-3/4" to 3-7/8"

**Packing:** 1 set = 2 clamps (as pictured)

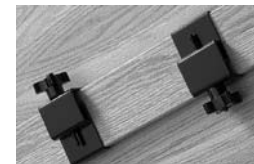

Item#	Color
MQGC1	Black



## EXPANDING SOCKETS For Mounting Drawer Slides



- Designed to knock into a 5mm diameter 32mm system hole
- Drawer slide is then screwed to the socket using wood screws
- Expanding socket gives superior holding power in particle board or MDF

**Packing:** Injection molded in packs of 20 sockets.

Full boxes of 500.

**Sold In:** Packs of 20 sockets.

Discount available for full box orders.

Item#	Length	Diameter
GF5MM	12mm	5mm

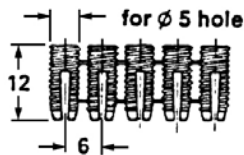

## BACKSPLASH FASTENERS



Installing the Smart Clip®: 1. Rout the laminated backsplash.

2. After measuring and drilling 12" intervals on backsplash, install screws (included) into the bottom of the backsplash.
3. Install the Smart Clip® on the countertop, butting the wall, using the screws provided.
4. Run a bead of caulk along the line of Smart Clips®, and drive the backsplash into position.

- Easy to use, install in minutes, are waterproof, and allow formfitting the backsplash of a countertop to nearly any wall surface

- Eliminates scribing, mastics, metals, and front caulking

**Packing:** As shown on right.

**Sold In:** Full box quantities only.

Item#	Description	Box Qty
TJCLIP-L	Smart Clip® 50 Pak	50
TJCLIP	Smart Clip®	250

### ACCESSORIES

TJSC1	Router Bit	1
TJ8	Depth Gauge	1
TJ5B	Spacing Bar	1



## TOP FASTENERS



- Ideal for connecting tops made of solid wood where expansion and contraction may be a problem
- The "leg" of the clip is allowed to "float" in a saw kerf allowing the top to breathe and not crack
- Uses #5 Flathead screws (not included)



**Packing:** As shown below.  
**Sold In:** Full box quantities only.

Item#	Gauge Steel	Width	Finish	Box Qty
KV324	14	3/4"	Steel	100

## KEYHOLE PLATES



- Used for assembling chairs, beds, cabinets, etc.
- Screws engage through the keyholes

Specifications:

- **IM67D:** Three holes countersunk for #6 flat head screws. Keyholes clamp with #10 round head screws for rigid connections. .095 gauge cold rolled steel, zinc plated.
- **IM67S:** Two holes countersunk for #6 flat head screws. Keyholes provide rigid connection with #10 round head screws. .095 gauge cold rolled steel, zinc plated.

**Packing:** As shown below.  
**Sold In:** Full box quantities only.

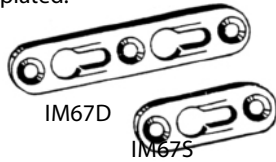

Item#	# of Keyholes	Size	Box Qty
IM67S-L	1	1-5/8"L x 9/16"W	50
IM67S	1	1-5/8"L x 9/16"W	500
IM67D-L	2	3"L x 9/16"W	50
IM67D	2	3"L x 9/16"W	1,000

## SURFACE MOUNTED POST HANGERS

- 4 male and 4 female pieces per set
- For board widths 4" to 7"; for larger widths, 2 units on each corner may be used for increased rigidity
- Surface mounted brackets require no mortising or machining

**Packing:** Sets of 4.  
**Sold In:** Full sets of 4 only. Discount for 50 set orders.

Item#	Length	Sets per Box
HE271-05-004-P	3-7/8"	1
HE271-05-004	3-7/8"	50



## DESK TOP FASTENERS



- Ideal for mounting tops to legs or table bases
- Packing:** As shown below.  
**Sold In:** Full box quantities only.



Item#	Gauge Steel	Length	Width	Finish	Box Qty
KV1547	12	1-1/4"	3/4"	Steel	100
KV1548	18	1-1/4"	3/4"	Zinc	500

## HANGER PLATES



- 1-13/16" L x 1/2" W
- Packing:** As shown below without screws.  
**Sold In:** Full box quantities only.

Item#	Finish	Box Qty
KV537ZC	Zinc	100



## TAPER CONNECTORS



- Designed for use wherever a strong invisible joint is required
- Helps achieve the flush mounting important on wall units
- One male and one female per set
- Recommended Fasteners: WW40505 (100 per box) or WW40500 (1,000 per box)

**Packing:** As shown below.  
**Sold In:** Full box quantities only.

Item#	Length	Width	Sets per Box
KD2020-4-L	4"	5/8"	50
KD2020-4	4"	5/8"	250

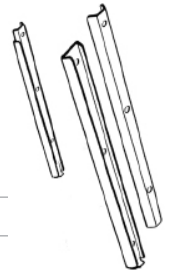

# SECTION P FASTENERS

# PANEL ASSEMBLY HARDWARE

## POST HANGERS

- For beds, booths, removable partitions, shelf brackets, etc.
- 4 male and 4 female pieces per set
- Recommended Fasteners:  
WW41955 (3/4"x8 flathead, box of 200)

**Packing:** Sets of 4 only.

**Sold In:** Full sets of 4 only.

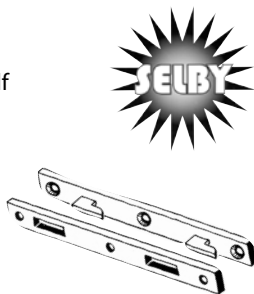

Length	Width	Sets of 4	Set of 4 Item #	Full Box # of Sets	Full Box Item #
3"	5/8"	1	KD1613-P	12	KD1613
4"	11/16"	1	KD1614-P	6	KD1614
5"	11/16"	1	KD1615-P	6	KD1615
6"	11/16"	1	-	6	KD1616

## INTERLOCKING PANEL ASSEMBLY HARDWARE

### Flushmount Hangers

- For wall-panels, wall-hung cabinets, mirrors, bed headboards, and displays
- Two interchangeable interlocking pieces mate perfectly to provide secure fastening in only 1/8" assembled thickness
- Made of .062" gauge steel, zinc plated
- Four screwholes are countersunk for #6 flat head screws

**Packing:** As shown below.

**Sold In:** Full box quantities only.

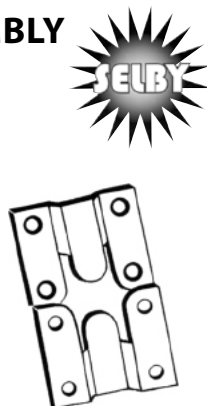

Item#	Size	Pairs per Box
KDFM100B-L	1-1/2"W x 1-3/4"H	50 pairs
KDFM100B	1-1/2"W x 1-3/4"H	500 pairs

## INTERLOCKING PANEL ASSEMBLY HARDWARE



### Handy Fast-Klip Assemblies

- Align the clips, fasten them to the panels and assemble by snapping the panels together
  - Strong 2-part (male and female) clip which forms a rigid assembly when connected
  - Can be repeatedly assembled and disassembled without affecting performance
  - Recommended fasteners WW44105 (box of 100) or WW44165 (box of 1,000)
- Packing:** As shown below without screws.
- Sold In:** Full box quantities only.



Item#	Finish	Box Qty
NB1504-C	Bright Zinc	100 pairs
NB1504	Bright Zinc	500 pairs

## JOINT FASTENERS

### Double Action Levelite Joint Fastener



- Ideal for field joints and other types of sectional clamping
- Draws the edges tight and also levels the two mating surfaces
- Set screws (included) compensate for different thicknesses of material and warping
- Recommended Mounting Screw:  
8 each #10 pan heads

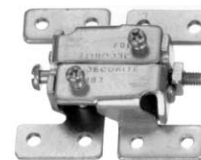

**Packing:** Standard box

quantities as shown to the right.

**Sold In:** Full box quantities only.

Discount available for full box quantities.

Item#	Box Qty
AV26WS-X	10
AV26WS	50

## INTERLOCKING PANEL ASSEMBLY HARDWARE

### "Keku" Push-In Fittings

- Designed for fastening panels to frames
- Components to be mounted are pushed on from the front eliminating the need for free space at the top or side as required by suspension fittings
- Panel element locks into the frame element as it is pushed home
- Fits 32mm system

NOTE: Each set consists of 1 male and 1 female component.

**Packing:** As shown below.

**Sold In:** Full box quantities only.

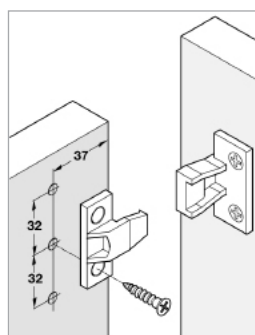

Item#	Color	Sets per Box
HE262-50-313-L	Black	50
HE262-50-313	Black	200

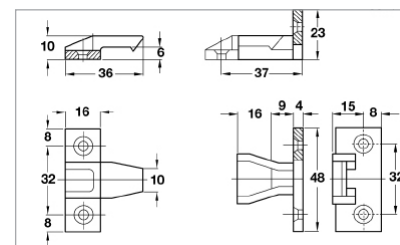

## INTERLOCKING PANEL ASSEMBLY HARDWARE "Keku" Suspension Fittings



- Allows for pre-assembly of sub-frames and cabinet components such as speaker fronts, wainscoting, radiator covers or wherever access will be needed after installation
- The system consists of a frame element and a panel element, both made out of a nylon material
- If required, suspended panels can be simply released at anytime without special tools
- Fits 32mm systems.



NOTE: Each set consists of 1 male and 1 female component.

**Packing:** As shown on right.

**Sold In:** Full box quantities only.

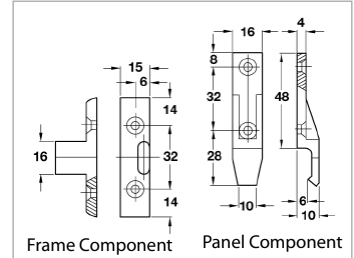
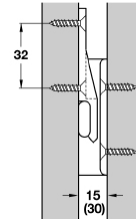
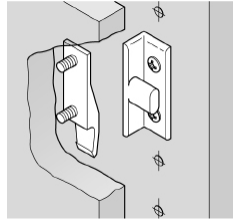

Item#	Color	Sets per Box
HE262-49-310-L	Black	50
HE262-49-310	Black	250

## PANEL FASTENING SYSTEM One Piece System



- Mount to your architectural panel with a #6 x 1/2" self-tapping screw (recommended spacing every 8" – 12", no pre-drilled holes)
- Only requires 3/16" lift-off and offers infinite adjustment
- No need for trim and finish-work
- The use of the 3" PowerHead screws allows for a tight, secure fit while allowing for side to side adjustment and in and out adjustment for walls that are not flat
- No shims required



Item#	Description	Size
FASMRCLT	Smart Cleat	1-3/4"H x 4'L x 3/4"D
FAPHZ3-150	150 Pack Powerhead Screws For Wood	3" x 8 Gauge

**Packing & Sold In:** Each

## INTERLOCKING PANEL ASSEMBLY HARDWARE Two Piece Aluminum Extrusions



- The system simply uses 2 interlocking (reversible) aluminum clips; one attached to the wall and one attached to the item being hung
- Continuous long clips (72" and 144") lengths are attached to the wall, while shorter clips (1-1/2", 2" and 3" long) are attached to the piece being hung
- Assembly is accomplished by sliding the piece being hung down along the wall until the clips engage
- Short clips have 3/16" diameter screwholes and will accept up to a #8 screw (truss or round head)
- The continuous long clips do not have pre-drilled screw holes

IMPORTANT NOTE: Wall clips and hang clips must be used in sets described below.

EA5337 and EA7031 are "universal style" meaning 72" pieces can be cut to length rather than buying short clips separately. Both items must be used together.

**Packing:** As shown below.

**Sold In:** Both broken and full box quantities. Discount available for full box orders.



EA5337-5339 Series

Item#	Drop	Description	Dimensions Width x Length	Thickness When Engaged	Holes per Clip	Box Qty
EA5337-1-1/2	5/8"	Short Hang Clip	1-7/8"W x 1-1/2"L	.175"	2	500
EA5337-72	5/8"	Long Wall Clip	1-7/8"W x 72"L	.175"	-	40
EA5339-3	1/2"	Short Hang Clip	1-1/4"W x 3"L	.250"	3	1,000
EA5339-72	1/2"	Long Wall Clip	1-1/4"W x 72"L	.250"	-	40
EA5338-3	1/2"	Short Hang Clip	1-7/8"W x 3"L	.175"	3	500
EA5338-72	1/2"	Long Wall Clip	1-7/8"W x 72"L	.175"	-	40
EA7031-2	3/8"	Short Hang Clip	2-3/4"W x 2"L	.250"	2	500
EA7031-144	3/8"	Long Wall Clip	2-3/4"W x 144"L	.250"	-	100

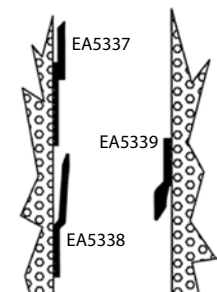
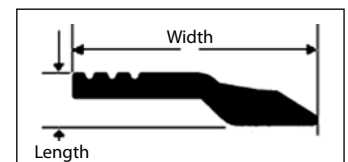





## PANEL RETAINING CLIPS

### Glass & Panel Retaining Clips

- Holds solid panels in place and prevents rattling by maintaining a soft pressure against the panel or glass
- Uses #5 flat head or oval head screw
- Made of plastic

**Packing:** As shown below without screws.

**Sold In:** Full box quantities only.

	Application Type	Color	Std Box Qty: 100 Item #	Bulk Box Qty: 1,000 Item #
A	Flush	Clear	PGH242CL-C	PGH242CL
	Flush	Tan	PGH242T-C	PGH242T
	Flush	Walnut	PGH242WAL-C	PGH242WAL
B	1/8" Inset	Clear	PGH261CL-C	PGH261CL
	1/8" Inset	Tan	PGH261T-C	PGH261T
	1/8" Inset	Walnut	PGH261WAL-C	PGH261WAL
C	3/16" Inset	Clear	PGH262CL-C	PGH262CL
	3/16" Inset	Tan	-	PGH262T
	3/16" Inset	Walnut	PGH262WAL-C	PGH262WAL
D	5/16" Inset	Clear	PGH264CL-C	PGH264CL
	5/16" Inset	Tan	PGH264T-C	PGH264T
	5/16" Inset	Walnut	PGH264WAL-C	PGH264WAL

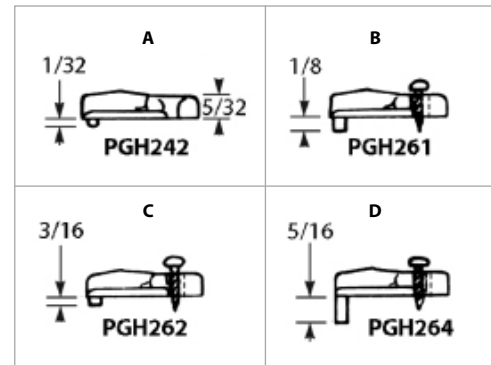
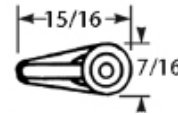

## PANEL RETAINER EXTRUSIONS

### Groove Or Staple Type



- Rubber extrusion holds wood panels and glass in place
- GROOVE TYPE: Holds panels by press-fitting of the extrusion in a groove between the panel and the frame.
- STAPLE TYPE: For wood panels only. Holds the panel in place by stapling in the groove provided in this quarter-round shape.

Specifications: Rubber 1/8" wide x 1/4" deep groove required to accept the extrusion

Accessory Items:

BL85529M - 3 wing Slotting Cutter, 5/16" Arbor Hole

BL92813 - 1/4" Shank Ball Bearing Arbor

**Packing:** As shown below.

**Sold In:** Full roll quantities only.

Type	Color	Std Box Qty: 100 LF Item #	Bulk Box Qty: 1,000 LF Item #
<b>GROOVE TYPE</b>			
Groove	White	EXC12514-032CO-C	EXC12514-032CO
Groove	Clear	EXC12514-806OO-C	EXC12514-806OO
Groove	Fruitwood	EXC12514-032TA-C	EXC12514-032TA
Groove	Dark Brown	EXC12514-032UY-C	EXC12514-032UY
<b>STAPLE TYPE</b>			
Staple	Fruitwood	EXC3733-032TA-C	EXC3733-032TA

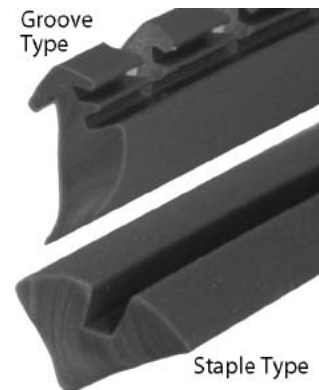



## TITE-JOINT (DOG BONE) FASTENERS Economy Countertop Fastener

- Hex head
  - Ideal for field joints in countertops
  - Steel, bright zinc plated
- Packing:** As shown on right.  
**Sold In:** Full box quantities only.

Item#	Brand	Bolt Size	Box Qty
WW49600	Wurth	3-1/2"	100
WW49700	Wurth	3-1/2"	500
KV517-100	KV	3-1/2"	100
WW49610	Wurth	4"	350
KV513-100	KV	4"	100

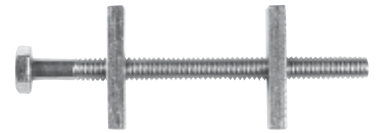

## TITE-JOINT (DOG BONE) FASTENERS



### Deluxe Tite-Joint Countertop Fastener



- Designed for 3/4" thick substrate
- Center to center 2" to 3-1/2"

**Packing:** As shown below.  
**Sold In:** Complete Tite Joints sold in full box quantities only. Components sold in both broken and full box quantities. Discount available for full box orders.

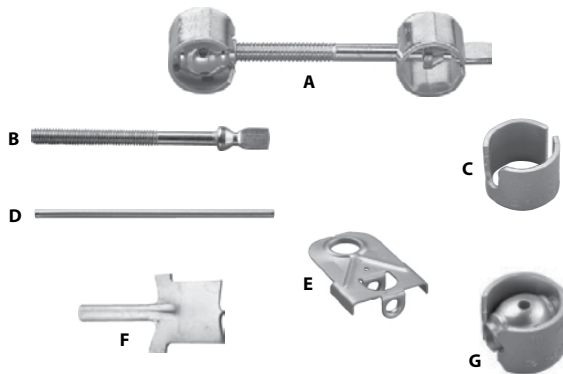

	Item #	Description	Box Qty
A	WWTJDELUXE-100	Complete Tite Joint, Economy	100
	KV516-25	Complete Tite Joint	25
	KV516-100	Complete Tite Joint	100

### COMPONENTS

	Item #	Description	Box Qty
B	KV516-1	Draw Bolt Only	25
C	KV516-60	Locking Sleeve	25
D	KV516-62	Tightening Rod	1
E	KV516-63	Drill Guide	4
F	KV516-64	Drill Bit	1
G	KV516-80	Tightening Assembly	25

## TITE-JOINT (DOG BONE) FASTENERS



### Zipbolt™ Tite-Joint Fastener

- Integrated gearing system
- Tighten using a 4mm hex drive bit in a drill, hand driver, or Allen key
- Can be tightened in just 3 seconds using the driver bit in a drill
- Each box contains a 4mm hex drive bit

**Packing:** As shown below.  
**Sold In:** Full box quantities only. Discount available for full case orders of Zipbolts.



Item#	Description	Box Qty	Case Qty
SCZIPBOLT	Zipbolt Fastener	60	360
SC4MMBIT	4mm Hex Drive Bit	1	1

## TITE-JOINT (DOG BONE) FASTENERS



### Tool-less Draw Bolt

- 4-1/2" long
- Place Flipbolt in cutout (template available), hand tighten nut, Flipbolt tightens when lever is pushed
- Jig works with both sizes of Flipbolt
- Available J-hook allows you to mount the Flipbolt without a routed recess

**Packing:** As shown below.  
**Sold In:** Both broken and full box quantities. Discount available for full box orders.

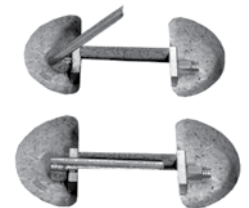

Item#	Description	Length	Box Qty
<b>FLIPBOLTS</b>			
FAFLIPBOLT-SHORT	FlipBolt	3-1/2"	50
FAFLIPBOLT	FlipBolt	4-1/2"	50
<b>ACCESSORIES</b>			
FAJHOOK	J Hook	-	1
FAFLIPBOLTJIG	Flip Bolt Template	-	1

# SECTION P FASTENERS

# HOOK & LOOP FASTENERS

## COUNTERTOP CONNECTOR Qwikdraw®



- Used for joining countertops, tabletops and work surfaces
- Does not require any special boring or machining
- Maintain perfect alignment and seam
- 12" in length

**Packing & Sold In:** Each

Item #	Size
FAQWIKDRAW	Connector
FACLMPADMICRO	Quickdraw Clamp Pad (2 pack)



**NEW  
ITEM!**

## VELCRO® BRAND FASTENER Hook & Loop On A Roll

- Width: 1" (+/- 2/32")
  - Weight: VOV10802-1: 4.7 gram per one inch yard (min. avg.)  
VOV10102-1: 5.9 gram per one inch yard (min. avg.)
  - Backed with self-stick adhesive and release paper, 8.0 pound per inch width minimum
- NOTE: The hook and loop components must be ordered separately.  
**Packing:** In rolls as shown to the right.  
**Sold In:** Any quantity of yards. Discount available for full roll orders.



**PRO  
VALUE SERIES**

Item#	Description	Color	Yards per Roll
VOV10802-1	1"W Hook Component, PSA	Black	25
VOV10102-1	1"W Loop Component, PSA	Black	25

## SCOTCHMATE™ BRAND FASTENER Hook & Loop



- 170 stems on one side; 400 stems on the other for a heavy duty, reclosable hold
- Backed with premium PSA; no staples or mechanical fasteners needed
- Bonds well to most substrates
- Maximum operating temperature 100°F
- Cut off what you need to minimize waste



**Packing:** One 15' roll of hook component and one 15' roll of loop component per box.  
**Sold In:** Full box quantities only.  
Discount available for full case orders.

Item#	Color	Tape Width x Roll Length	Boxes Per Case
MM06488	White	1" x 15'	5

## DUAL LOCK™ BRAND FASTENER Heavy Duty Reclosable Fastener



- Maximum operating temperature 100°F
- Continuous plastic strips with mushroom shaped stems
- 170 stems on one side; 400 stems on the other for a heavy duty, reclosable hold
- Pressure sensitive adhesive back for bonding to bare or painted metal, plastics, wood, glass and more
- Solvent resistant
- Cut off what you need to minimize waste



**Packing:** One 15' roll of 170 stem component and one 15' roll of 400 stem component per box.  
**Sold In:** Full box quantities only. Discount available for full case orders.

Item#	Color	Tape Width x Roll Length	Boxes Per Case
MM06463	Clear w/Clear Adhesive	1" x 15'	5

## WALL ANCHORS Drywall Anchor, Multi-Drive



- Install into 3/8" to 1" wallboard
- Available in two materials; nylon or zinc
- Patented drive can be installed with Pozi, AW or Torx bits
- Minimal space requirement behind sheet (only 15mm)
- Use with sheet metal or drywall screws - screws are removable

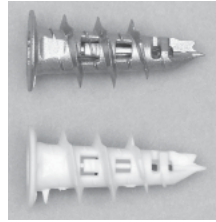

**Packing:** As shown below.

**Sold In:** Full box quantities only.

Item#	Material	Length x Gauge	Box Qty
WW903251	Nylon	1-3/8" x 6	200
WW903252	Zinc	1-3/8" x 6	200

## WALL ANCHOR RocLoc Drywall Anchor



- Designed to work with 1/2" or 5/8" drywall
- Use a 1/2" drill bit to bore hole for insertion
- Resists shear and does not allow the load to slide
- Does not destroy drywall; removable and reusable
- Load capacity up to 100 lbs. based on age, condition and quality of drywall

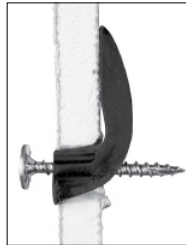

**Packing:** 10 RocLocs and 1-1/4" PowerHead screws per pack.

**Sold In:** Full pack quantities only.

Item#	For Material Thickness
FAROCLOC-1/2	1/2"
FAROCLOC-5/8	5/8"



## WALL ANCHORS Drywall Anchor, Phillips Drive



- Install into 3/8" to 1" wallboard with just a Phillips screwdriver
- Drills its own hole and drives into the wall in one motion
- Use with sheet metal or drywall screws - screws are removable

**Packing:** As shown below.

**Sold In:** Full box quantities only.

Item#	Material	Length x Gauge	Box Qty
RWNZIP6	Nylon	1-3/8" x 6	100
RWNZIP8	Nylon	1-3/4" x 8	100
RWZZIP8	Zinc	1-3/4" x 8	100

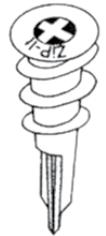

## WALL ANCHORS Screw Anchor



- Screw actuated hollow wall anchor for use in wallboard, solid masonry or hollow doors
- Uses standard sheet metal screws (#6 - #12)

**Packing:** As shown below.

**Sold In:** Full box quantities only.

Item#	Wall Thickness	Drill Dia.	Box Qty
RW2305	5/8"	5/16"	100





## T-NUTS

- Hammer into drilled holes to provide threads that simplify joining wood to wood or metal to metal pieces
- Prongs prevent turning.

**Packing:** Standard boxes of 100 and bulk packs of 500 as shown below.

**Sold In:** Full box quantities only.

Thread Size	Bore Hole Diameter	Flange Diameter	Barrel Height	Prong Height	Gauge	Box Qty: 100 Item #	Box Qty: 500 Item #
<b>3 PRONG</b>							
8-32	7/32"	1/2"	1/4"	3/16"	.031	-	TN083243
10-24	1/4"	3/4"	5/16"	7/32"	.040	-	TN102453
1/4-20	5/16"	3/4"	5/16"	7/32"	.045	TN142053-C	TN142053
5/16-18	3/8"	3/4"	3/8"	1/4"	.052	TN561863T-C	TN561863T
<b>4 PRONG</b>							
5/16-18	15/32"	1"	7/16"	11/32"	.062	TN381674T-C	TN381674T

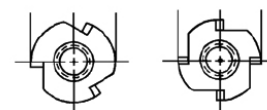

3 Prong Type    4 Prong Type

## SIMPLEX INTERLOCKING PLATES

### Aluminum

- Detachable joining element that consists of two parts and fits into Lamello slots
- For use in fixing fix radiator concealments, ceiling elements, screens, furniture parts, shelves, brackets, door doubles etc

**Packing:** As shown below.

**Sold In:** Full box quantities only.

Item#	Box Qty
LM166101	100 pieces (50 pairs)



## SIMPLEX INSERTION TOOL

Use: Detachable joining elements of aluminum for strong, easily fitted and dismantelable joints.

1. Cut the slots with a Lamello groove milling machine: 13 mm. deep and 4 mm. wide.
2. Apply two-component glue into the grooves and on to the elements (LM166101).
3. Insert Simplex fitting using the insertion tool (LM166110).
4. Allow to dry thoroughly, then join up.

- Used for inserting LM166101 Simplex interlocking plates

**Packing & Sold In:** Each

Item#
LM166110

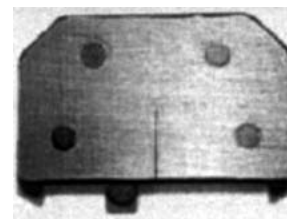

## WOOD BISCUITS

### Standard Compressed Beech

- The three most common biscuit sizes for use with all standard plate joiners such as Porter-Cable, Lamello, Freud, Ryobi, DeWalt and other popular makes
- Gridded surface for uniform glue spreading
- Cross ribs for easy insertion
- Flat ends so surplus glue remains inside the groove

**Packing:** Box quantities of 1,000.

**Sold In:** Full box quantities only



Biscuit Size	Excel Dowel Item #	Lamello Item #	Porter Cable Item #
#0	CDBI-0	LM144000	RK5551
#10	CDBI-10	LM144010	RK5552
#20	CDBI-20	LM144020	RK5553

## WOOD BISCUITS

### Face Frame H-9 Compressed Beech

- Measures only 1-1/2" long, but is a full 1/2" wide
- Slimmer than a #0 plate to allow use in thinner materials, or to "double-up" for extra strength
- Gridded surface for uniform glue spreading
- Cross ribs for easy insertion
- Flat ends so surplus glue remains inside the groove
- High breaking strength and finely ground edges

**Packing:** As shown below.

**Sold In:** Full box quantities only.



Item#	Biscuit Size	Dimensions Width x Length	Box Qty
LM144009	#H-9 Biscuit	12mm W x 38mm L	1,000

## PLASTIC BISCUITS

### C-20 Plastic

- Made of translucent C-20 plastic, environmentally friendly polypropylene
- For joining solid surface materials
- No glue required

**Packing:** As shown below.

**Sold In:** Full box quantities only.



Item#	Dimensions Width x Length	Box Qty
LM156110	23 mm W x 60mm L	250

## WOOD BISCUITS

### Round #S-11 Compressed Beech

- Used with LM132011-1/2 router bit in a router or router table
- Provides extra depth and strength on stock widths down to 2 inches
- Use for joining stair railings and banisters

**Packing:** As shown below.

**Sold In:** Full box quantities only.



Item#	Diameter	Thickness	Box Qty
LM144011	35mm	4mm	1,000

## CLAMPING PLATE

### K-20 Plastic

- Used with items that are difficult to clamp such as screens and large workpieces
- Made of environmentally friendly plastic
- Barbed cross-ribs for a secure hold
- No glue required

**Packing:** As shown below.

**Sold In:** Full box quantities only.



Item#	Dimensions Width x Length	Box Qty
LM145000	24mm W x 60mm L	250

## DOWEL PINS

### Fluted Groove Hardwood Inch & Metric Sizes



- Available in pre-glued and non-glued versions
- To insert pre-glued versions simply replace glue with water; if inserting by hand, spray hole with water

**Packing:** Standard bags of 1,000 and bulk bags as shown below.

**Sold In:** Full standard and bulk bag quantities. Discount available for bulk bag orders.

Diameter	Length	Std Bag Qty	Item #	Bulk Bag Qty	Item #
<b>NON-GLUED INCH SIZES</b>					
1/4"	1-1/2"	1,000	CD2500150M	-	-
1/4"	2"	1,000	CD2500200M	-	-
5/16"	1-3/16"	1,000	CD3125136M	-	-
5/16"	1-1/2"	1,000	CD3125150M	-	-
5/16"	2"	1,000	CD3125200M	-	-
3/8"	1-1/2"	1,000	CD3750150M	20,000	CD3750150
3/8"	2"	1,000	CD3750200M	13,000	CD3750200
<b>NON-GLUED METRIC SIZES</b>					
8mm (5/16")	25mm (1")	1,000	CD825M	23,000	CD825
8mm (5/16")	30mm (1-3/16")	1,000	CD830M	19,200	CD830
8mm (5/16")	32mm (1-17/64")	1,000	CD832M	17,800	CD832
8mm (5/16")	35mm (1-3/8")	1,000	CD835M	16,400	CD835
8mm (5/16")	38mm (1-1/2")	1,000	CD838M	15,000	CD838
<b>PRE-GLUED METRIC SIZES</b>					
8mm (5/16")	30mm (1-3/16")	1,000	CD830PGM	10,000	CD830PG
8mm (5/16")	32mm (1-17/64")	-	-	20,000	CD832PG
8mm (5/16")	35mm (1-3/8")	1,000	CD835PGM	10,000	CD835PG



Multi-grooved  
Unglued



Multi-grooved  
Pre-glued

## DOWEL PINS

### Spiral Grooved Metric Sizes



- Dowels have the groove cut in a spiral pattern along the full length of the dowel to allow glue to release and provide an expanded glue surface

**Packing:** Standard bags of 1,000 as shown below.

**Sold In:** Full bag quantities only.

Diameter	Length	Std Bag Qty	Item #
1/4"	2"	1,000	CD2500200S
5/16"	1-1/2"	1,000	CD3125150S
5/16"	2"	1,000	CD3125200S
3/8"	1-1/2"	1,000	CD3750150S
3/8"	2"	1,000	CD3750200S





## DOWEL RODS

### Unfinished Smooth Hardwood

- Dowel rods are made of New England hardwoods, Red Oak or Poplar
- Dowel rods can be painted, lacquered, varnished, etc.
- Available in three lengths 3', 4' and 6'

**Packing:** As shown below.

**Sold In:** Both broken and full bundle quantities.

Discount available for full bundle orders.



3 FOOT LENGTH				
Smooth Hardwood			Red Oak	
Dia.	Rods per Bundle	Item #	Rods per Bundle	Item #
1/8"	100	CD1836	-	-
3/16"	100	CD31636	-	-
1/4"	100	CD1436	100	CD1436O
5/16"	100	CD51636	-	-
3/8"	100	CD3836	100	CD3836O
7/16"	50	CD71636	-	-
1/2"	50	CD1236	50	CD1236O
5/8"	25	CD5836	25	CD5836O
3/4"	25	CD3436	25	CD3436O
1"	10	CD136	10	CD136O
1-1/4"	-	-	10	CD11436O

4 FOOT LENGTH		
Smooth Hardwood		
Dia.	Rods per Bundle	Item #
1/4"	100	CD1448
5/16"	100	CD51648
3/8"	100	CD3848
1/2"	50	CD1248
5/8"	25	CD5848
3/4"	25	CD3448
7/8"	15	CD7848
1"	10	CD148
1-1/8"	10	CD11848
1-1/4"	10	CD11448

6 FOOT LENGTH		
Poplar		
Dia.	Rods per Bundle	Item #
1"	10	CD172
1-1/4"	10	CD11472
1-1/2"	10	CD11272
2"	10	CD272

## MENDING PLATES

- Zinc plated rust resistant steel
- Countersunk screw holes
- Screws not included

**Packing:** Bulk boxes packed.

**Sold In:** Std box are available any quantity.

Bulk boxes sold in full box quantities only.

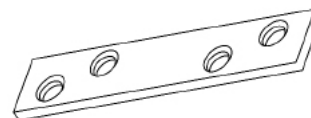
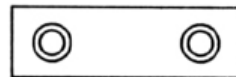

Length x Width	Recommended Screw Size	Number of Screwholes	Item #	Item #	Bulk Box Qty
2" L x 1/2"W	#5	2	FR225ZC-2S	-	-
3" L x 3/4"W	#6	4	FR225ZC-3S	FRB225ZC-3N	700
4" L x 3/4"W	#6	4	FR225ZC-4S	FRB225ZC-4	500

## CORNER BRACES

### Chair Brace

- Uses 3/4" x #10 flathead wood screws
- Stamped steel, zinc plated finish
- Screws not included

**Packing:** As shown below.

**Sold In:** (FR) Item # available any quantity; (KV) Item # sold in full box quantities only.



Item#	Size	Box Qty
FR232ZCS	1"W x 1"L	500
KV342	2"L x 2"W	100

## CORNER BRACES

### Horizontal Corner Iron

- Zinc plated rust resistant steel
- Countersunk screw holes, screws not included

**Packing & Sold In:** Each

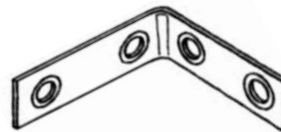

Brace Size (Length x Length x Height)	Recommended Screw Size	# Screw Holes	Std Box Qty Item #	Bulk Box Qty Item #
1"L x 1"L x 1/2"H	#6	2	48 FR226ZC-1S	- -
2"L x 2"L x 5/8"H	#6	4	48 FR226ZC-2S	700 FRB226ZC-2

## CORNER BRACES

### Plastic Glue Boxes



- Made of high impact, specially compounded plastic material
- Can be stapled through without shattering and will also accept glue
- Off-center screwholes to provide easier screwgun access into the corner of the cabinet
- Braces are 3-5/8" long and 3/4" deep

• A) Has no tabs; B) Has tabs extending out; C) Has tabs projecting up

**Packing:** As shown below.

**Sold In:** Full box quantities only.

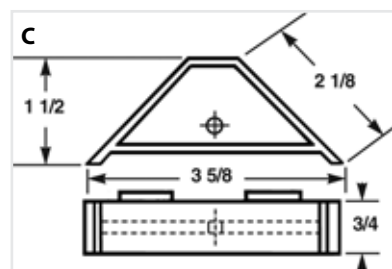
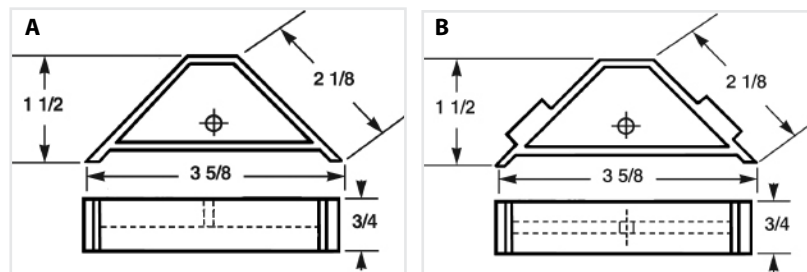

	Color	Std Box Qty Item #	Bulk Box Qty Item #
A	Tan	100 PGH441E-C	1,200 PGH441E
B	Tan	100 PGH443E-C	1,200 PGH443E
C	Brown	100 PGH445E-C	1,200 PGH445E

## SYSTEM 3 FITTINGS FOR FACE & EDGE BORING 2 Piece (Male/Female) Component System

- Two component rigid face and edge drilled fastening with half turn to fasten
- System 3 offers almost full concealment and wide tolerances in use
- Choice of dowels to suit drilling
- Recommended Boring Bits:
  - Housing Assemblies: AA203251 25mm RH bit
  - Dowels: AA201005 5mm RH bit

**Packing:** Standard bag or box quantities as shown below.

**Sold In:** Full bag or box quantities only. Discount available for full box quantities.

Item#	Drilling Depth (D)	Material	Color	Bag Qty	Box Qty
<b>HOUSING ASSEMBLY</b>					
TT3118-831	12.5mm	Plastic/Zinc	Dark Brown	100	2,500
TT3118-823	12.5mm	Plastic/Zinc	Magnolia	100	2,500
TT3118-877	12.5mm	Plastic/Zinc	White	100	2,500
<b>SCREW-IN DOWELS</b>					
Item#	Dowel Size	Material	Finish	Bag Qty	Box Qty
TT3181-881	3mm x 30mm	Plastic/Zinc	Zinc	100	4,000
TT3165-883	5mm x 30mm	Plastic/Zinc	Zinc	100	2,500

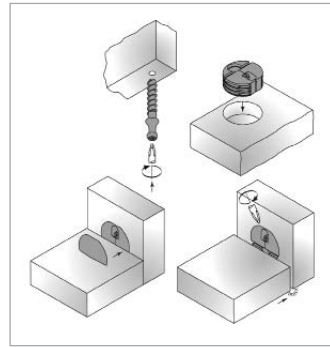

# Titus



Housing Assembly

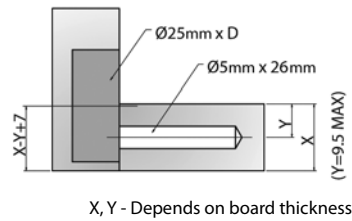

TT3168-883

TT3181-881

## SYSTEM 4 EXPANDING CONNECTORS FOR DRAWER CONSTRUCTION One Piece Quickloc™, Tool-less

# Titus

- For 15mm and thicker panels
- Integrated expanding housing and dowel provide consistently stronger joints
- One piece connector capable of hand insertion
- Highly tolerant and tightens in less than one turn
- Face-bored product
- High degree of drilling tolerance
- Only connector of its type to provide pull-up of cabinet panels when tightened
- Recommended Boring Bit:
  - AA203201 20mm RH bit

**Packing:** Standard bag or box quantities as shown below.

**Sold In:** Full bag or box quantities only.

Discount available for full box quantities.

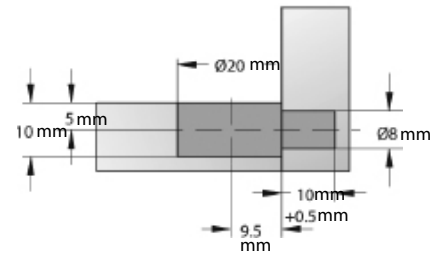
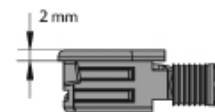
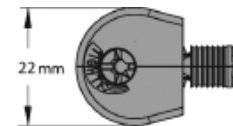

Item#	Material	Color	Bag Qty	Box Qty
TT6803-835	Plastic/Zinc	Black	100	2,500



## SYSTEM 5 FITTINGS FOR PANEL TO PANEL APPLICATIONS

### 15mm Diameter, 2 Piece (Male/Female) Component System

- Typically used in eurostyle casework, furniture, panel to panel (wood to wood) applications
- Also used as modified case clamps to hold furniture pieces together until glued in dowels dry
- Ensures perfectly aligned joints without rigid drilling restrictions
- "Klix" locking feature provides a strong, vibration proof joint
- Linear cam profile results in smooth, easy cam rotation and dowel pull-up
- Available for 15mm/16mm (5/8") and 18mm/19mm (3/4") boards
- Recommended Boring Bit: AA203152 15mm RH Boring Bit

**Packing:** Standard bag or box quantities as shown below.

**Sold In:** Full bag or box quantities only. Discount available for full box quantities.

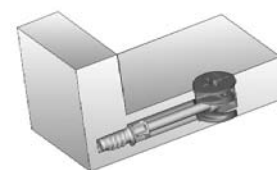

Housing Item#	For Panel Thickness (A)	Drilling Depth (B)	Drilling for Dowel (C)	Material	Finish	Bag Qty	Box Qty
TT5644-885	18mm/19mm (5/8")	12.7mm	7.5 – 8mm	Zinc	Zinc	100	2,000
TT5656-885	15mm/16mm (3/4")	14mm	9-9.5mm	Zinc	Zinc	100	2,000

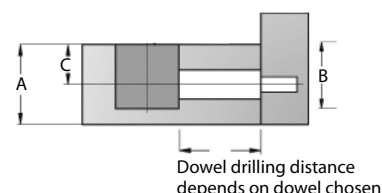

### SYSTEM 5 DOWEL OPTIONS



TT9424-885  
Page P-58



TT5534-885  
Page P-58



TT5570-880  
Page P-59



TT5441-880  
Page P-59

## SYSTEM 5 DOWELS FOR PANEL TO PANEL APPLICATIONS

### Screw-In Combi, Torsion & Pull-Out Resistant

- High quality zinc (thread) and steel (pin) dowel with greater resistance to torsion and pull-out
- Steel pin allows magnetic bit use for ease of installation
- "Klix" locking feature provides a strong, vibration proof joint
- Depth stop collar for accurate insertion
- Recommended Boring Bit: AA201005 5mm RH Boring bit

**Packing:** Standard bag or box quantities as shown below.

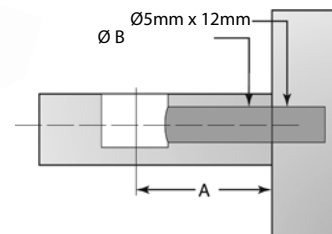

Dowel Item#	Drilling Distance (A)	Drilling Diameter for Dowel Body (B)	Material	Finish	Bag Qty	Box Qty
TT9423-885	24mm	7-8 mm	Steel/Zinc	Zinc	100	2,000
TT9424-885	34mm	7-8 mm	Steel/Zinc	Zinc	100	2,000



## SYSTEM 5 DOWELS FOR PANEL TO PANEL APPLICATIONS Push-In Quickfit, Expands After Insertion For Stronger Hold

- Used in panel to panel (wood to wood) applications
- Easily push into the hole by hand
- Precise cam drilling required
- "Klix" locking feature provides a strong, vibration proof joint
- Depth stop collar for accurate insertion
- 10mm drilling diameter for dowel thread
- Recommended Boring Bit: AA201010 10mm RH Boring bit

**Packing:** Standard bag or box quantities as shown below.

**Sold In:** Full bag or box quantities only. Discount available for full box quantities.

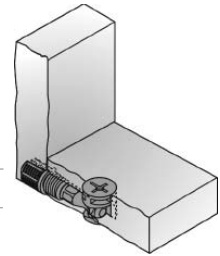
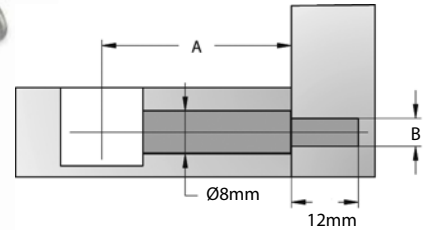

Dowel Item#	Drilling Distance (A)	Drilling Diameter for Dowel Head (B)	Material	Color	Bag Qty	Box Qty
TT5570-880	24mm	10mm	Plastic/Zinc	Dark Gray/Zinc	100	2,000
TT5572-880	34mm	10mm	Plastic/Zinc	Dark Gray/Zinc	100	1,000

## SYSTEM 5 DOWELS FOR PANEL TO PANEL APPLICATIONS Push-In Quickfit-TL2, Self-Adjusting



- Used in panel to panel (wood to wood) applications
- Expands after insertion for a solid hold
- $\pm 1$ mm edge to hole drilling tolerance allows for easier assembly
- "Klix" locking feature provides a strong, vibration proof joint
- Highly tolerant in edge-inserted applications
- Recommended Boring Bit: AA201008 8mm RH Boring bit

**Packing:** Standard bag or box quantities as shown below.

**Sold In:** Full bag or box quantities only. Discount available for full box quantities.

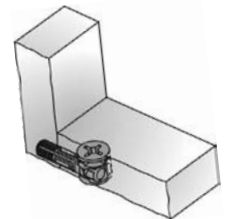
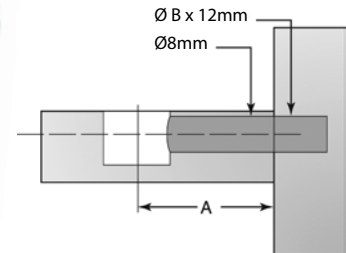

Dowel Item#	Drilling Distance w/Tolerance Range (A)	Drilling Diameter for Dowel Thread (B)	Material	Color	Bag Qty	Box Qty
TT5441-880	24mm (23-27mm)	8mm	Plastic/Zinc	Dark Gray/Zinc	100	2,000
TT5474-880	34mm (33-37mm)	8mm	Plastic/Zinc	Dark Gray/Zinc	100	1,000

## SYSTEM 6 FITTINGS FOR CLOSET & CASE GOODS CONSTRUCTION DROP-ON HOUSINGS

### 20mm Diameter, Non-Outrigger & Outrigger

- Drop on cams feature a slight lip on the inside to help secure the top shelf until screw is set
- Available in two styles:
  - Non-Outrigger style is most economical
  - Outrigger style offers easy alignment and added strength
- Available for 15/16mm (5/8") and 18/19mm (3/4") panels
- Ideal for use in high volume production
- Can be machine inserted or knocked in with a hammer
- Minimum drilling requirements; no edge boring required
- Linear cam design for constant tightening loads when driving
- Angledrive feature on cam for maximum driving comfort
- Recommended Boring Bits:

Non-Outrigger Cams: AA203201 20mm RH Boring Bit

Outrigger Cams: AA201010 and AA203201 10mm and 20mm RH Boring Bits

**Packing:** Standard bag or box quantities as shown below.

**Sold In:** Full bag or box quantities only. Discount available for full box quantities.

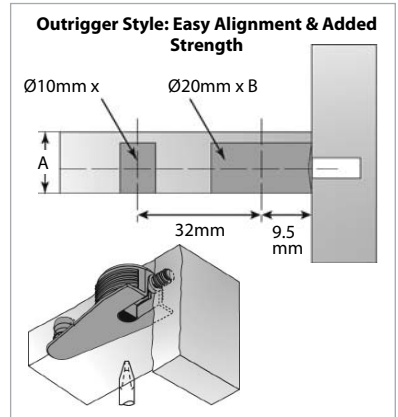
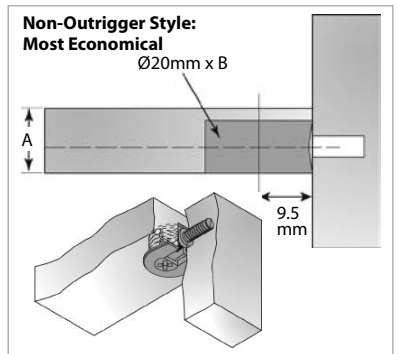
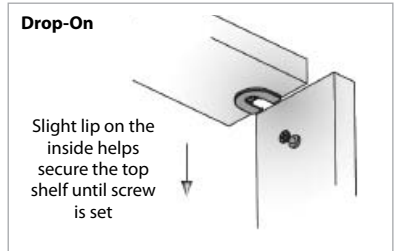

Housing Item#	For Panel Thickness (A)	Drilling Depth (B)	Material	Color/Finish	Bag Qty	Box Qty
<b>NON-OUTRIGGER STYLE CAMS</b>						
TT6383-877	15mm/16mm (5/8")	12.5mm	Plastic/Zinc	White	100	2,500
TT6447-847	15mm/16mm (5/8")	12.5mm	Zinc	Nickel	100	1,000
TT6387-841	18mm/19mm (3/4")	14mm	Plastic/Zinc	Almond	100	2,500
TT6387-835	18mm/19mm (3/4")	14mm	Plastic/Zinc	Black	100	2,500
TT6387-898	18mm/19mm (3/4")	14mm	Plastic/Zinc	Brown	100	2,500
TT6387-927	18mm/19mm (3/4")	14mm	Plastic/Zinc	Candlelight	100	2,500
TT6387-877	18mm/19mm (3/4")	14mm	Plastic/Zinc	White	100	2,500
TT6449-847	18mm/19mm (3/4")	14mm	Zinc	Nickel	100	1,000
<b>OUTRIGGER STYLE CAMS</b>						
TT6439-841	15mm / 16mm (5/8")	12.5mm	Plastic/Zinc	Almond	50	1,250
TT6439-835	15mm / 16mm (5/8")	12.5mm	Plastic/Zinc	Black	50	1,250
TT6439-898	15mm / 16mm (5/8")	12.5mm	Plastic/Zinc	Brown	50	1,250
TT6439-927	15mm / 16mm (5/8")	12.5mm	Plastic/Zinc	Candlelight	50	1,250
TT6439-877	15mm / 16mm (5/8")	12.5mm	Plastic/Zinc	White	50	1,250
TT6397-841	18mm / 19mm (3/4")	14mm	Plastic/Zinc	Almond	50	1,250
TT6397-835	18mm/19mm (3/4")	14mm	Plastic/Zinc	Black	50	1,250
TT6441-835	18mm / 19mm (3/4")	14mm	Plastic/Zinc	Black	50	1,250
TT6397-898	18mm / 19mm (3/4")	14mm	Plastic/Zinc	Brown	50	1,250
TT6397-927	18mm / 19mm (3/4")	14mm	Plastic/Zinc	Candlelight	50	1,250
TT6397-877	18mm / 19mm (3/4")	14mm	Plastic/Zinc	White	50	1,250







## SYSTEM 6 FITTINGS FOR CLOSET, CASE GOODS CONSTRUCTION SIDE ENTRY HOUSING

### 20mm Diameter Cams, Non-Outrigger & Outrigger

- Ideal for use in high volume production
- Available in two styles:
  - Non-Outrigger style is most economical
  - Outrigger style offers easy alignment and added strength
- Available for 15/16mm (5/8") and 18/19mm (3/4") panels
- Can be machine inserted or knocked in with a hammer
- Linear cam design for constant tightening loads when driving
- Angledrive feature on cam for maximum driving comfort
- Recommended Boring Bits:
  - Non-Outrigger Cams: AA203201 20mm RH Boring Bit
  - Outrigger Cams: AA201010 and AA203201 10mm and 20mm RH Boring Bits

**Packing:** Standard bag or box quantities as shown below.

**Sold In:** Full bag or box quantities only. Discount available for full box quantities.

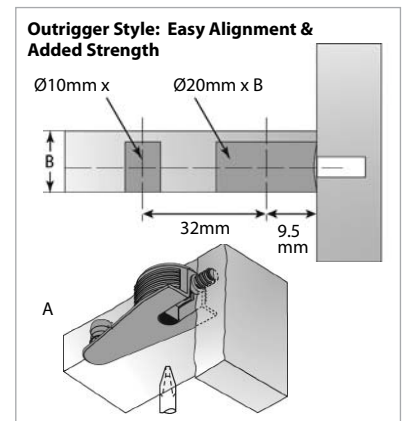
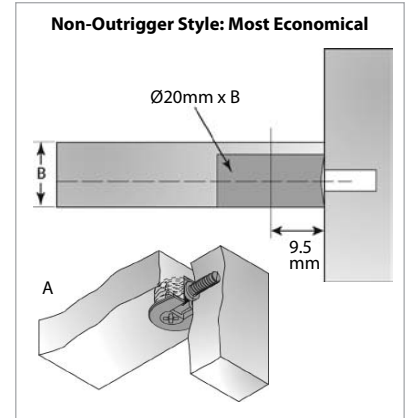
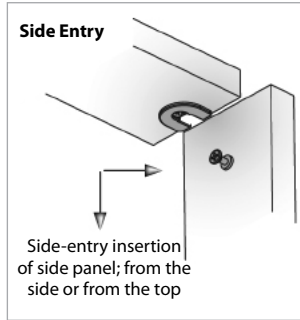

Item#	For Panel Thickness (B)	Drilling Depth (D)	Material	Color/Finish	Bag Qty	Box Qty
<b>NON-OUTRIGGER STYLE CAMS</b>						
TT6381-877	15mm/16mm (5/8")	12.5mm	Plastic/Zinc	White	100	2,500
TT6385-841	18mm/19mm (3/4")	14mm	Plastic/Zinc	Almond	100	2,500
TT6385-877	18mm/19mm (3/4")	14mm	Plastic/Zinc	White	100	2,500
TT6453-847	18mm/19mm (3/4")	14mm	Zinc	Nickel	100	1,000
<b>OUTRIGGER STYLE CAMS</b>						
TT6443-877	15mm/16mm (5/8")	12.5mm	Plastic/Zinc	White	50	1,250
TT6445-841	18mm/19mm (3/4")	14mm	Plastic/Zinc	Almond	50	1,250
TT6395-841	18mm/19mm (3/4")	14mm	Plastic/Zinc	Almond	50	1,250
TT6395-877	18mm/19mm (3/4")	14mm	Plastic/Zinc	White	50	1,250
TT6461-847	18mm/19mm (3/4")	14mm	Zinc	Nickel	50	500

### SYSTEM 6 DOWEL OPTIONS



## DOWELS FOR BACK TO BACK OR PANEL TO PANEL APPLICATIONS SYSTEM 6 DOWELS

### Push-In Quickfit-Expando For a Tight Joint

- Available for both back to back and panel to panel applications
- Can be removed without damage to panel surface
- Plastic expanding sleeve for a secure hold
- Threaded for 5mm system holes
- Depth collar stop for accurate insertion
- Recommended Boring Bit: AA201005 5mm RH Boring Bits

**Packing:** Standard bag or box quantities as shown below.

**Sold In:** Full bag or box quantities only.

Discount available for full box quantities.

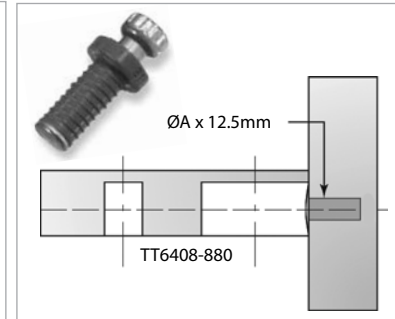
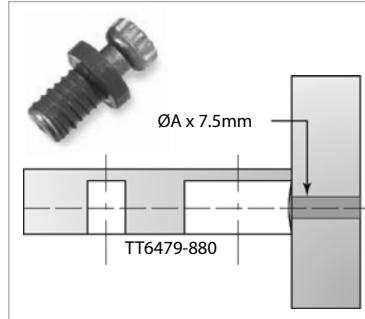

Dowel Item#	Application	Drilling Diameter For Dowel Thread (A)	Material	Color/Finish	Bag Qty	Box Qty
TT6479-880	Back To Back	5mm	Plastic/Zinc	Dark Gray/Zinc	100	5,000
TT6408-880	Panel To Panel	5mm	Plastic/Zinc	Dark Gray/Zinc	100	5,000

## DOWELS FOR PANEL TO PANEL APPLICATIONS SYSTEM 6 DOWELS

### Screw-In

- Standard screw-in dowel for KD (knock-down) fittings
- Threaded for 5mm system holes
- Dowels feature an integral skirt which acts as a positive stop during insertion
- Recommended Boring Bit: AA201005 5mm RH Boring Bits

**Packing:** Standard bag or box quantities as shown below.

**Sold In:** Full bag or box quantities only. Discount available for full box quantities.

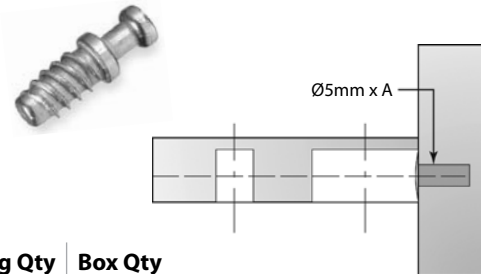

Dowel Item#	Drilling Length For Dowel Thread (A)	Material	Finish	Bag Qty	Box Qty
TT6401-885	9mm	Zinc	Zinc	100	5,000
TT6406-885	11.5mm	Zinc	Zinc	100	5,000



## DOWELS FOR PANEL SHARING APPLICATIONS SYSTEM 6 DOWELS

### Double Ended Push-In

- For panel sharing applications - double dowel slides through center panel to lock in shelves on both sides
- Threaded for 5mm system holes
- Available for 15mm/16mm (5/8") and 18mm/19mm (3/4") panels
- Recommended Boring Bit: AA201005 5mm RH Boring Bits

**Packing:** Standard bag or box quantities as shown below.

**Sold In:** Full bag or box quantities only. Discount available for full box quantities.

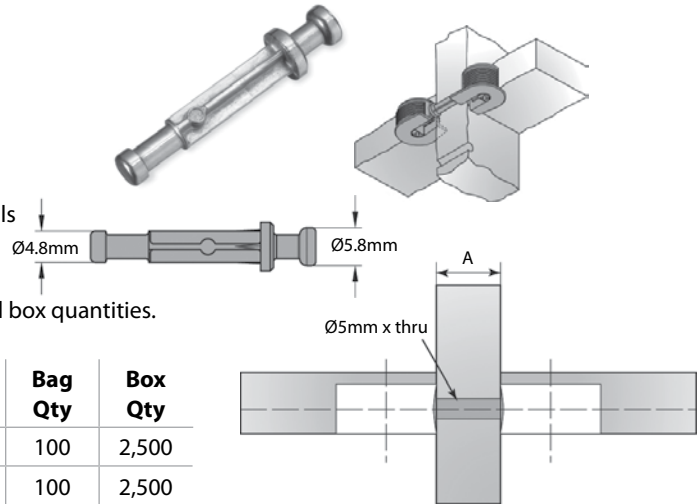

Dowel Item#	For Panel Thickness (A)	Material	Finish	Bag Qty	Box Qty
TT6414-885	15mm/16mm (5/8")	Zinc	Zinc	100	2,500
TT6416-885	18mm/19mm (3/4")	Zinc	Zinc	100	2,500

## SCREW CARRYING CASE 16 Compartment (Empty)

- Empty 16 compartment metal carrying case allows you to create your own Installation/Assembly Kit
- Overall Size: 18-1/2"W x 12" D x 2-3/4" H
- Each Compartment: 4"W x 2-1/4" D x 2-1/4" H

**Packing:** Each quantities.

**Item#**

WW16M

