

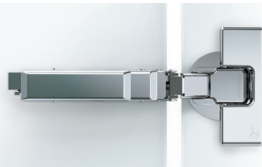

Selling Guide for Common Applications

G*GRASS®

TIOMOS HINGE SYSTEM



TIOMOS – Unique Selling Points:

Adjustable Soft-close Damper

- meets customer expectations for Soft-close function

New design in Soft-close mechanism

- fully integrated into the body of the hinge

Standard Cup Depth

- ease of conversion and compatibility with existing designs

Full program of Soft-close and Self-close Hinges

- 110° / 160°, Frame and Frameless

Improved Kinematics

- no other design can offer as much design flexibility

New base plate design

- offering “worm gear” adjustment technology
- large improvement over eccentric cam design adjustment

Proven strength / durability

- building on Grass 3000 series reputation and legacy

3 Soft-close settings

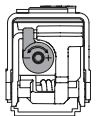

Top Setting
Large and heavy doors

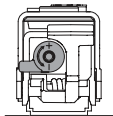

Middle Setting (factory setting) Standard door
(Covers 80% of applications)

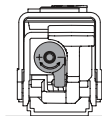

Bottom Setting
Small and light-weight doors

Outstanding Soft-close characteristic:

New design in Soft-close mechanism

- no rebound effect - continuous, smooth closing action
- closing time < 4 sec.
- uniform closing regardless of door material and door dimensions

Tool-free Soft-closing adjustment

Adjustment located at back of hinge arm

Adjustment lever locks in position for each setting

New base plate design

3D adjustment

Side, depth and height adjustment

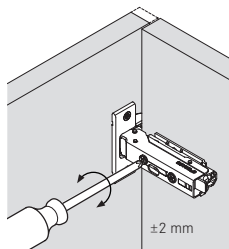

Side adjustment

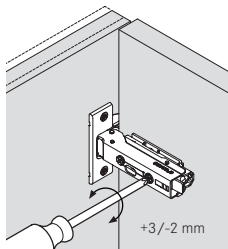

Depth adjustment
via worm gear

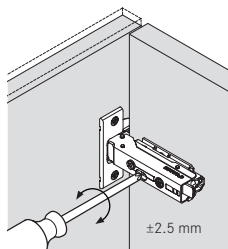

Height adjustment
via base plate

Cup Drilling Distance

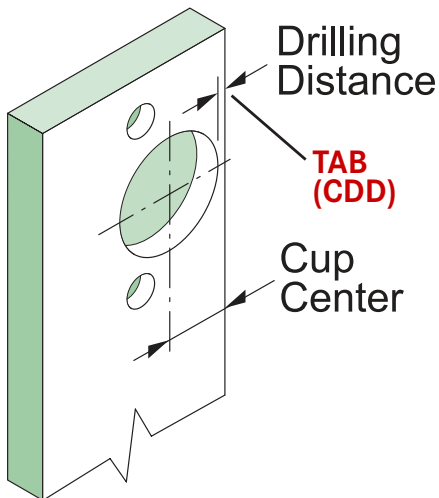

Frameless Cabinet Applications

Overlay 19mm (3/4") side panels:

16mm (5/8") Overlay,

Tab (CDD) 4mm (5/32")

45mm Pattern, Blum &
Salice machines, new
GRASS machines

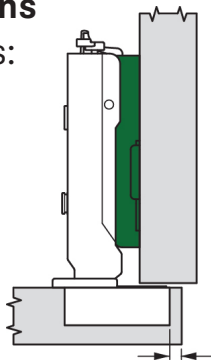

TAB (CDD) 4mm (5/32")

DOWELLED	Description	Item No.
Soft-close	Tiomos 110 VS8 Overlay	F028 138524228
Self-close	Tiomos 110 VS8 Overlay	F045 138462228
Euro Screw	Tiomos 00/ES/37 1D Wing plate	F058 139761228
SCREW-ON	Description	Item No.
Soft-close	Tiomos 110 VS Overlay	F028 138520228
Self-close	Tiomos 110 VS Overlay	F045 138458228
Wood Screw	Tiomos 00/4.2/37 1D Wing plate	F058 139746228

Frameless Cabinet Applications

Overlay 19mm (3/4") side panels:

17mm (11/16") Overlay,

Tab (CDD) 5mm (13/64")

45mm Pattern, Blum &
Salice machines, new
GRASS machines

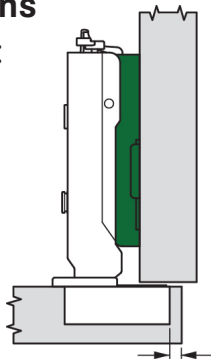

TAB (CDD) 5mm (13/64")

DOWELLED	Description	Item No.
Soft-close	Tiomos 110 VS8 Overlay	F028 138524228
Self-close	Tiomos 110 VS8 Overlay	F045 138462228
Euro Screw	Tiomos 00/ES/37 1D Wing plate	F058 139761228
SCREW-ON	Description	Item No.
Soft-close	Tiomos 110 VS Overlay	F028 138520228
Self-close	Tiomos 110 VS Overlay	F045 138458228
Wood Screw	Tiomos 00/4.2/37 1D Wing plate	F058 139746228

Frameless Cabinet Applications

Half Overlay 19mm (3/4") side panels:

6.5mm (1/4") Overlay,

Tab (CDD) 4mm (5/32")

45mm Pattern, Blum &
Salice machines, new
GRASS machines

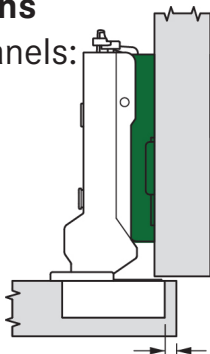

TAB (CDD) 4mm (5/32")

DOWELLED	Description	Item No.
Soft-close	Tiomos 110 VS8 Half Overlay	F028138525228
Self-close	Tiomos 110 VS8 Half Overlay	F045138463228
Euro Screw	Tiomos 03/ES/37 1D Wing plate	F058139763228
SCREW-ON	Description	Item No.
Soft-close	Tiomos 110 VS Half Overlay	F028138521228
Self-close	Tiomos 110 VS Half Overlay	F045138459228
Wood Screw	Tiomos 03/4.2/37 1D Wing plate	F058139748228

Frameless Cabinet Applications

Half Overlay 19mm (3/4") side panels:

7.5mm (5/16") Overlay,

Tab (CDD) 5mm (13/64")

45mm Pattern, Blum &
Salice machines, new
GRASS machines

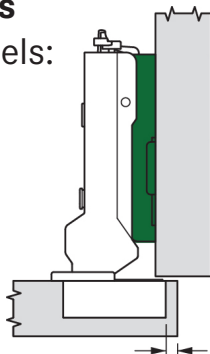

TAB (CDD) 5mm (13/64")

DOWELLED	Description	Item No.
Soft-close	Tiomos 110 VS8 Half Overlay	F028 138525228
Self-close	Tiomos 110 VS8 Half Overlay	F045 138463228
Euro Screw	Tiomos 03/ES/37 1D Wing plate	F058 139763228
SCREW-ON	Description	Item No.
Soft-close	Tiomos 110 VS Half Overlay	F028 138521228
Self-close	Tiomos 110 VS Half Overlay	F045 138459228
Wood Screw	Tiomos 03/4.2/37 1D Wing plate	F058 139748228

Pie Cut Corner (Lazy Susan) Cabinets

Overlay 19mm (3/4") side panels:

16mm (5/8") Overlay, Wide angle

Tab (CDD) 3.5mm (9/64"),
PCC Tab (CDD) 3.5mm (9/64")

45mm Pattern, Blum &
 Salice machines, new
 GRASS machines

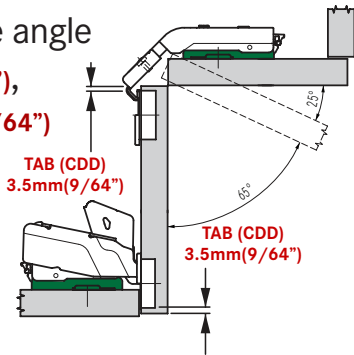

DOWELLED	Description	Item No.
Soft-close	Tiomos 160 VS8 Overlay	F028 138565217
Self-close	Tiomos 160 VS8 Overlay	F045 138503217
	Tiomos PCC VS8 Overlay	F045 138518228
Euro Screw	Tiomos 00/ES/37 1D Wing plate	F058 139761228
SCREW-ON	Description	Item No.
Soft-close	Tiomos 160 VS Overlay	F028 138562217
Self-close	Tiomos 160 VS Overlay	F045 138500217
	Tiomos PCC VS Overlay	F045 138517228
Wood Screw	Tiomos 00/4.2/37 1D Wing plate	F058 139746228

Face Frame Cabinet Applications

19mm (3/4") Overlay,

Tab (CDD) 5mm (13/64")

45mm Pattern, Blum &
Salice machines, new
GRASS machines

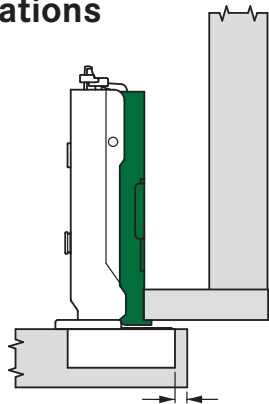

TAB (CDD) 5mm (13/64")

DOWELLED	Description	Item No.
Soft-close	Tiomos 110 VS8 Overlay	F028 138523228
Self-close	Tiomos 110 VS8 Overlay	F045 138461228
Wood Screw	Tiomos FFA 1.5/4.2 1D Face Frame	F058 139825228
SCREW-ON	Description	Item No.
Soft-close	Tiomos 110 VS Overlay	F028 138519228
Self-close	Tiomos 110 VS Overlay	F045 138457228
Wood Screw	Tiomos FFA 1.5/4.2 1D Face Frame	F058 139825228

Face Frame Cabinet Applications

15.5mm (5/8") Overlay,

Tab (CDD) 5mm (13/64")

45mm Pattern, Blum &
Salice machines, new
GRASS machines

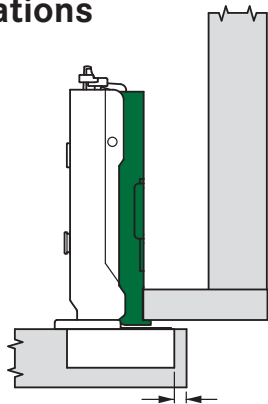

TAB (CDD) 5mm (13/64")

DOWELLED	Description	Item No.
Soft-close	Tiomos 110 VS8 Overlay	F028138524228
Self-close	Tiomos 110 VS8 Overlay	F045138462228
Wood Screw	Tiomos FFA 1.5/4.2 1D Face Frame	F058139825228
SCREW-ON	Description	Item No.
Soft-close	Tiomos 110 VS Overlay	F028138520228
Self-close	Tiomos 110 VS Overlay	F045138458228
Wood Screw	Tiomos FFA 1.5/4.2 1D Face Frame	F058139825228

Face Frame Cabinet Applications

14.5mm (9/16") Overlay,

Tab (CDD) 4mm (5/32")

45mm Pattern, Blum &
Salice machines, new
GRASS machines

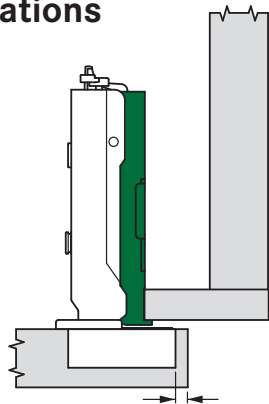

TAB (CDD) 4mm (5/32")

DOWELLED	Description	Item No.
Soft-close	Tiomos 110 VS8 Overlay	F028 138524228
Self-close	Tiomos 110 VS8 Overlay	F045 138462228
Wood Screw	Tiomos FFA 1.5/4.2 1D Face Frame	F058 139825228
SCREW-ON	Description	Item No.
Soft-close	Tiomos 110 VS Overlay	F028 138520228
Self-close	Tiomos 110 VS Overlay	F045 138458228
Wood Screw	Tiomos FFA 1.5/4.2 1D Face Frame	F058 139825228

Face Frame Cabinet Applications

12.5mm (1/2") Overlay,
Tab (CDD) 4mm (5/32")

45mm Pattern, Blum &
 Salice machines, new
 GRASS machines

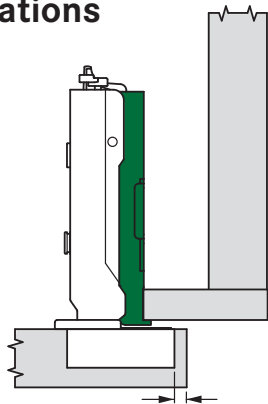

TAB (CDD) 4mm (5/32")

DOWELLED	Description	Item No.
Soft-close	Tiomos 110 VS8 Overlay	F028138524228
Self-close	Tiomos 110 VS8 Overlay	F045138462228
Wood Screw	Tiomos FFA 3.5/4.2 1D Face Frame	F058139826228
SCREW-ON	Description	Item No.
Soft-close	Tiomos 110 VS Overlay	F028138520228
Self-close	Tiomos 110 VS Overlay	F045138458228
Wood Screw	Tiomos FFA 3.5/4.2 Face Frame	F058139826228

Face Frame Cabinet Applications

Inset,

Tab (CDD) 3mm (1/8")

45mm Pattern, Blum &
Salice machines, new
GRASS machines

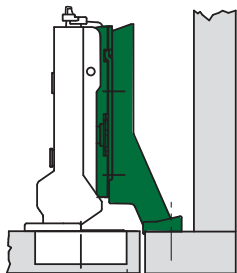

TAB (CDD) 3mm (1/8") → ← **Reveal 1mm**

DOWELLED	Description	Item No.
Soft-close	Tiomos 110 VS8 Half Overlay	F028 138525228
Self-close	Tiomos 110 VS8 Half Overlay	F045 138463228
Wood Screw	Tiomos FFA 00/4.2 1D Inset plate FF	F058 139831228
SCREW-ON	Description	Item No.
Soft-close	Tiomos 110 VS Half Overlay	F028 138521228
Self-close	Tiomos 110 VS Half Overlay	F045 138459228
Wood Screw	Tiomos FFA 00/4.2 1D Inset plate FF	F058 139831228



GRASS America Inc.
1202 NC Highway 66 South
Kernersville, NC 27284
Phone 1-800-334-3512
Fax 1-800-525-8406
Internet: www.grassusa.com
E-Mail: info@grassusa.com

GRASS Canada
10 Newgale Gate, Unit 7
Toronto, ON M1X 1C5
Phone 1-800-461-4975
Fax 1-416-335-5907
Internet: www.grasscanada.com
E-Mail: info@grasscanada.com

