



## ORGA-LINE and AMBIA-LINE

Adjustable organization systems designed for  
MOVENTO, TANDEM, TANDEMBOX and LEGRABOX

[blum.com](http://blum.com)

 **blum**<sup>®</sup>

## Functional Versatility

Elegant, easy to use, adjustable organization systems such as ORGA-LINE and AMBIA-LINE are becoming essential items in the kitchen.

Specifically designed for MOVENTO, TANDEM, TANDEMBOX and LEGRABOX, these systems and accessories assist in the daily workflow by making your kitchen more functional.







## Contents

- 6 ORGA-LINE
- 8 MOVENTO & TANDEM
- 12 TANDEMBOX
- 18 ORGA-LINE Accessories
- 20 AMBIA-LINE
- 22 LEGRABOX
- 26 AMBIA-LINE Accessories



## Blum's Ideas for Functional Kitchens

Our products stem from years of research into the needs of kitchen users as observed in their homes and our kitchen labs throughout the world. Our research has shown that functional kitchens have three essential features: smooth workflows, enough storage space and better motion.

[www.blum.com/ideas](http://www.blum.com/ideas)

### Workflow – Convenience

Cooking utensils, open ingredients or flatware – Blum's organizational systems provide order within your drawers, minimizing effort.



### Space – Optimization

Wide, high and deep drawers use more of the space available. With AMBIA-LINE or ORGA-LINE, you can organize your storage space and tailor it to your needs.



### Motion – Quality

Easy opening and silent and effortless closing drawers increase comfort in the kitchen. At Blum, this is achieved with state-of-the-art technology.



Ideas from Blum  
for practical kitchens













### Flexibility

Trays and cross dividers can be arranged to suit your specific needs, and the trays can even be removed for setting the table.



### Versatility

ORGA-LINE utensil dividers can be arranged as needed for a variety of applications throughout the home, not just the kitchen.



### Practicality

The high quality stainless steel trays are easy to clean without damaging the material, even in the dishwasher — safe up to 170° F.



### Accessories

ORGA-LINE kitchen accessories help simplify workflows. These accessories help ensure everything is exactly where it's needed.









## ORGA-LINE for Flatware

This adjustable organization solution for wood drawers is ideal for flatware. The removable containers are perfect for setting the table or tossing in the dishwasher. Combine kits to suit wider cabinets.

To calculate inside drawer width available:

**MOVENTO** Opening width\* - 42 (1-21/32")

**TANDEM** 13-16 drawer side thickness: Opening width\* - 42 (1-21/32")

16-19 drawer side thickness: Opening width\* - 49 (1-15/16")

### Flatware

- Width 284 (11-3/16")
- Height 65 (2-9/16")

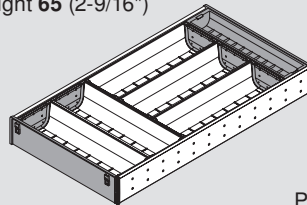

Part no.

21" drawer length

ZHI.533BI3A

### Flatware

- Width 381 (15")
- Height 65 (2-9/16")

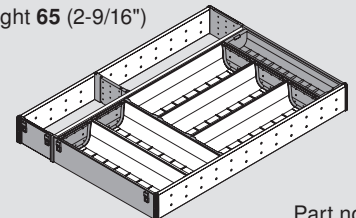

Part no.

21" drawer length

ZHI.533KI4A

### Flatware

- Width 400 to 419 (15-3/4" to 16-1/2")
- Height 65 (2-9/16")

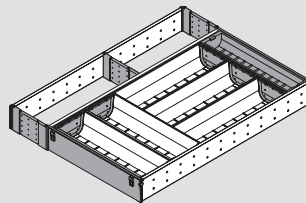

Part no.

21" drawer length

ZHI.533TI4A

### Flatware

- Width 477 to 495 (18-3/4" to 19-1/2")
- Height 65 (2-9/16")

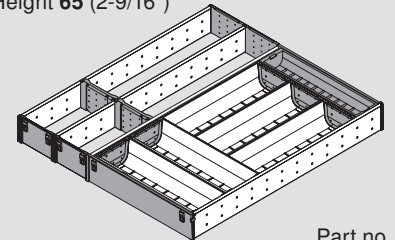

Part no.

21" drawer length

ZHI.533TI5A



\*To calculate Opening Width, refer to the MOVENTO/TANDEM brochure.

## ORGA-LINE for Utensils and Odds and Ends

Top drawers often store utensils and odds and ends. With ORGA-LINE, your items stay neatly in place. This customizable system is made of stainless steel dividers and trays, making it easy to adapt to any drawer configuration. The flexible utensil dividers ensure a perfect fit for items of every shape and size.

To calculate inside drawer width available:  
**MOVENTO** Opening width\* - **42** (1-21/32")  
**TANDEM** 13-16 drawer side thickness:  
 Opening width - **42** (1-21/32")  
**16-19** drawer side thickness: Opening  
 width - **49** (1-15/16")

### Odds and ends

- Width **108** (4-1/4")
- Height **65** (2-9/16")

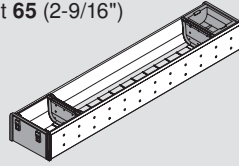

Part no.

21" drawer length

**ZHI.533B11A**

### Utensils

- Width **108** (4-1/4")
- Height **65** (2-9/16")

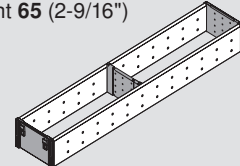

Part no.

21" drawer length

**ZHI.533F11A**

### Odds and ends

- Width **302** (11-7/8")
- Height **65** (2-9/16")

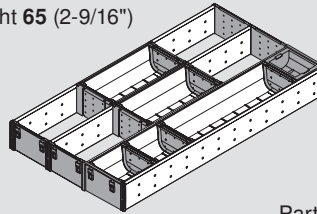

Part no.

21" drawer length

**ZHI.533MI3A**

### Utensils

- Width **294** (11-9/16")
- Height **65** (2-9/16")

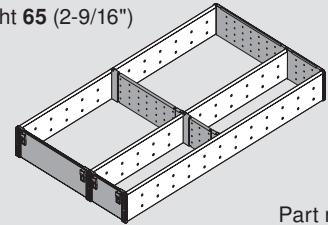

Part no.

21" drawer length

**ZHI.533FI3A**



\*To calculate Opening Width, refer to the MOVENTO/TANDEM brochure.



## ORGA-LINE for Deep Drawers

Storing items in a deep wood drawer is easy with ORGA-LINE. Items like pots and pans or plastic containers can be stored with their lids in one drawer, and the lids are always easy to find. If you ever change the items stored in your drawers, ORGA-LINE can quickly be rearranged, making it a great adjustable storage option.

To calculate inside drawer width available:  
**MOVENTO** Opening width\* - 42 (1-21/32")  
**TANDEM 13-16** drawer side thickness:  
 Opening width - 42 (1-21/32")  
**16-19** drawer side thickness: Opening  
 width - 49 (1-15/16")

**A Interior side rail**

- Two required
- Length 475 (18-11/16")
- Height 131 (5-3/16")

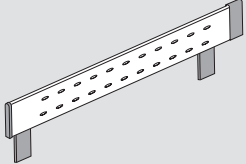

Part no.

Interior side rail **ZHI.533SS65**

**B Cross divider**

- Length 1077 (42-3/8"), cut to size
- Inside drawer width minus 62 (2-7/16")
- Height 113 (4-1/2")
- Gray

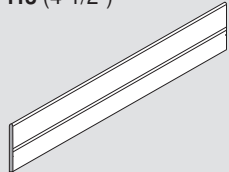

Part no.

Cross divider **Z40H1077A**

**C Spring loaded connector**

- Two required
- Dust gray



Part no.

Spring loaded connector **Z40H000A**

**D Lateral divider**

- Length 100 (3-15/16")
- Height 116 (4-9/16")
- Gray

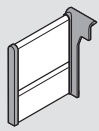

Part no.

Lateral divider **Z43H100S.01**

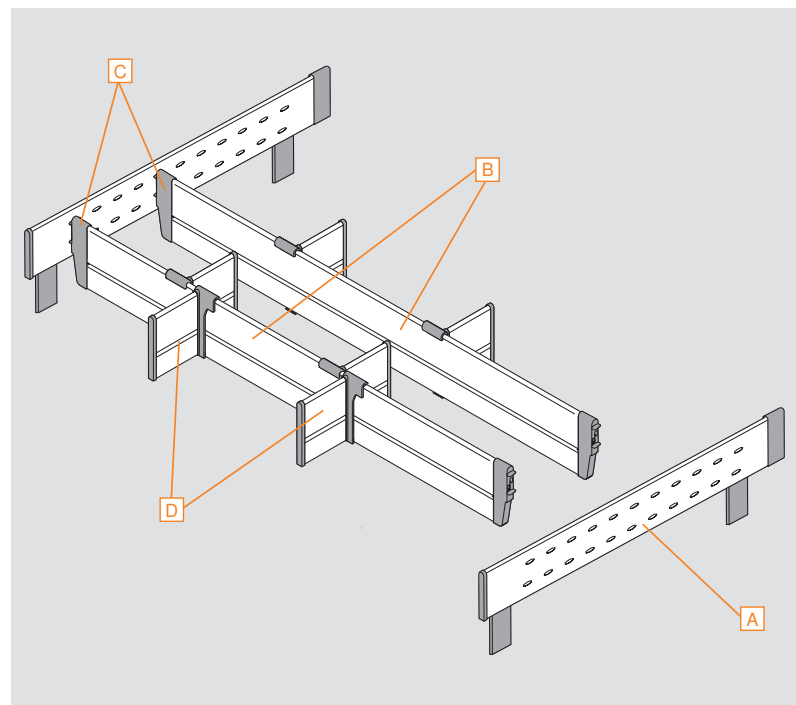

\*To calculate Opening Width, refer to the MOVENTO/TANDEM brochure.

## ORGA-LINE for TANDEMBOX

ORGA-LINE for TANDEMBOX is Blum's solution for metal drawers. The adjustable organization is not only ideal for top drawers, but deep drawers, too.

The removeable trays are made of high quality nylon and stainless steel, and are dishwasher safe up to 170° F. You can be sure they will last the lifetime of your kitchen.





## ORGA-LINE for Flatware

This adjustable organization solution for TANDEMBOX is ideal for flatware. The removable containers are perfect for setting the table or tossing in the dishwasher. Combine kits to suit wider cabinets.

To calculate inside drawer width available:

**TANDEMBOX** Inside cabinet width - **84** (3 - 5/16")

### Flatware

- Width **280** (11")
- Height **64** (2-1/2")

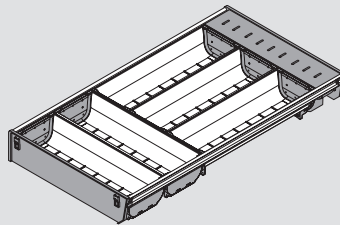

Part no.

**500** (20")

**ZSI.500BI3A**

**550** (22")

**ZSI.550BI3A**

### Flatware

- Width **377** (14-13/16")
- Height **64** (2-1/2")

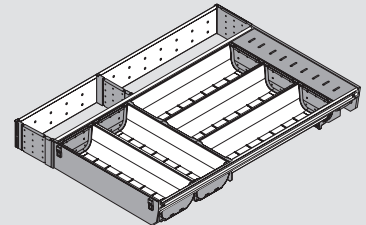

Part no.

**500** (20")

**ZSI.500KI4A**

**550** (22")

**ZSI.550KI4A**



## ORGA-LINE for Utensils

ORGA-LINE for utensils is a great solution for storing items of all shapes and sizes. The individual trays can be rearranged to suit your specific needs. The kits can be combined to suit a wide range of cabinet widths.

To calculate inside drawer width available:  
**TANDEMBOX** Inside cabinet width - **84**  
 (3 - 5/16")

### Utensils

- Width **105** (4-1/8")
- Height **64** (2-1/2")

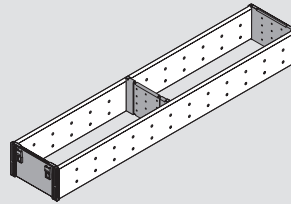

Part no.

500 (20")

ZSI.500F11

550 (22")

ZSI.550F11

### Utensils

- Width **291** (11-7/16")
- Height **64** (2-1/2")

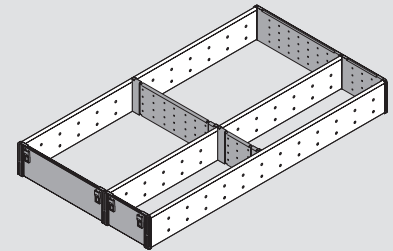

Part no.

500 (20")

ZSI.500F13

550 (22")

ZSI.550F13





## ORGA-LINE for Odds and Ends

Organize odds and ends with the ORGA-LINE adjustable organization system. The customizable trays make it easy to adapt to any drawer configuration throughout the home. Combine sets to suit wider applications.

To calculate inside drawer width available:  
**TANDEMBOX** Inside cabinet width - **84**  
 (3 - 5/16")

### Odds and ends

- Width **103** (4-1/16")
- Height **64** (2-1/2")

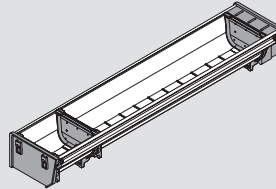

Part no.

500 (20")	<b>ZSI.500BI1N</b>
550 (22")	<b>ZSI.550BI1N</b>

### Odds and ends

- Width **297** (11-11/16")
- Height **64** (2-1/2")

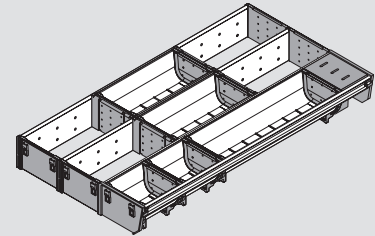

Part no.

500 (20")	<b>ZSI.500MI3</b>
550 (22")	<b>ZSI.550MI3</b>





## ORGA-LINE for D height TANDEMBOX with Design Element or BOXCAP

Designed to work with TANDEMBOX D height deep drawers, this organization system allows you to customize each deep drawer with stylish dividers.

To calculate inside drawer width available:  
**TANDEMBOX** Inside cabinet width - **84**  
 (3 - 5/16")

### Bottle storage set

- Width **220** (8-11/16")
- Height **165** (6-1/2")
- Stainless steel

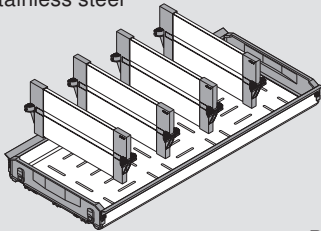

Part no.

500 (20")	ZFL.30BF16
550 (22")	ZFL.30BF17

### Inside divider

- Height **151** (5-15/16")
- Stainless steel

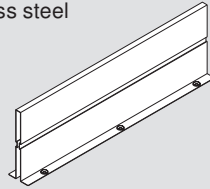

Part no.

500 (20")	Z46L470I
550 (22")	Z46L520I

### Adapter profile

- Stainless steel
- One required if using the bottle storage set (all other applications, two required)

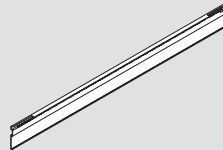

Part no.

450 (18")	Z49L422I
500 (20")	Z49L472I
550 (22")	Z49L522I
600 (24")	Z49L572I
650 (26")	Z49L622I

### Spring loaded connectors

- Two required
- Dust gray



Part no.

Spring loaded connectors	Z40L0002
--------------------------	----------

### Lateral divider

- Length **100** (3-15/16")
- Height **116** (4-9/16")
- Stainless steel



Part no.

Lateral divider	Z43L100I
-----------------	----------

### Cross divider

- Length **1077** (42-3/8"), cut to size
- Opening width minus **91** (3-9/16")
- Height **113** (4-1/2")
- Brushed nickel

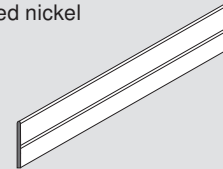

Part no.

Cross divider	Z40L1077A
---------------	-----------

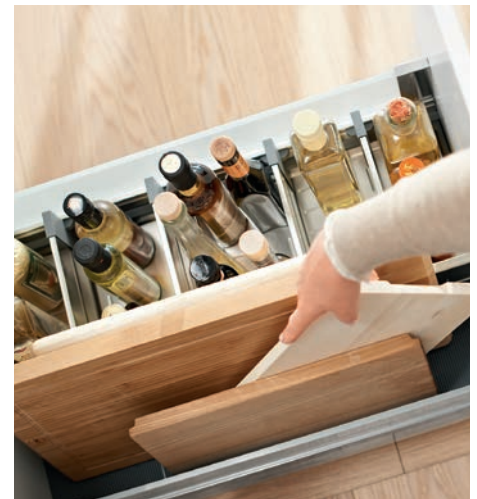

## ORGA-LINE for B or D Height TANDEMBOX with Gallery Rails

An ideal organization system designed to work with TANDEMBOX deep drawers using gallery rails. Elegant and easy to build, simply use the divider and connector system to customize your drawers.

To calculate inside drawer width available:  
**TANDEMBOX** Inside cabinet width - **84**  
 (3 - 5/16")

### A Cross gallery rail divider

- Length **1118** (44-1/32")
- Opening width minus **63** (2-1/2")
- Available in brushed nickel or gray

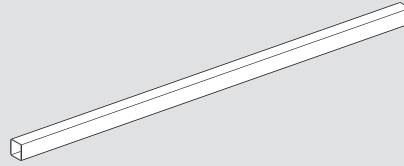

Part no.

Cross gallery rail divider

**ZRG.1118Q**

### B Cross gallery rail connector

- Two required
- Available in light gray or dust gray

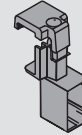

Part no.

Cross gallery rail connector

**ZRU.01E0**

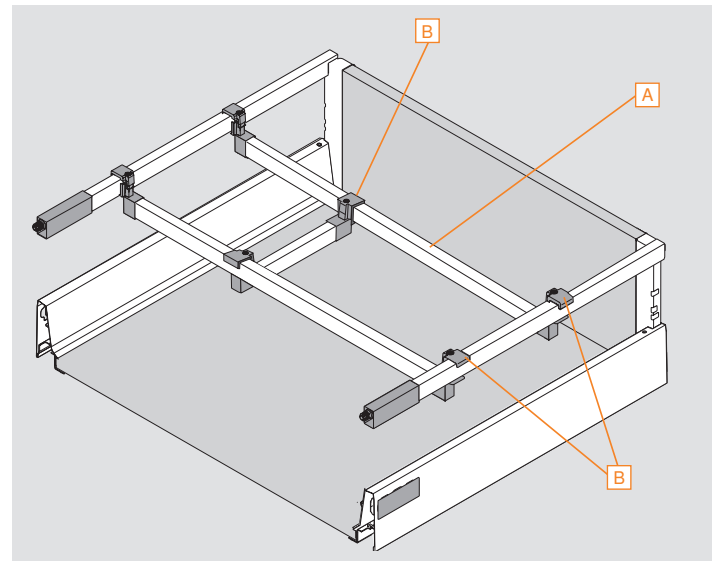



## Accessories for ORGA-LINE

**Knife holder:** The ORGA-LINE Knife holder keeps the counter clear for prepping, while keeping knives safely within reach.

**Spice tray:** The ORGA-LINE Spice tray keeps spices neatly organized – the tray can be removed from the drawer, keeping the spices where you need them most.

**Plate holder:** With Blum's Plate holders, storing plates in a drawer is now possible. The holder keeps plates neatly stacked without sliding around, and makes it easy to pick up the entire stack of plates for serving.

### ORGA-LINE Knife holder

- Length **280** (11")
- Width **180** (7-1/8")
- Holds up to nine knives of different sizes
- High quality nylon and stainless steel
- Dishwasher safe up to 170°F
- Handle supports (qty 4)

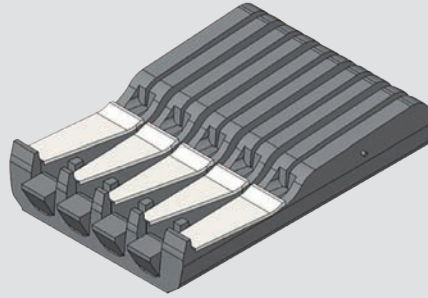

Part no.

Knife holder

**ZSZ.02M0**

### ORGA-LINE Spice tray

- Width **282** (11-1/8")
- Inside storage width **260** (10-1/4")
- Height **121** (4-3/4")
- Easy removal from drawer
- High quality nylon and stainless steel
- Set includes two trays and four feet

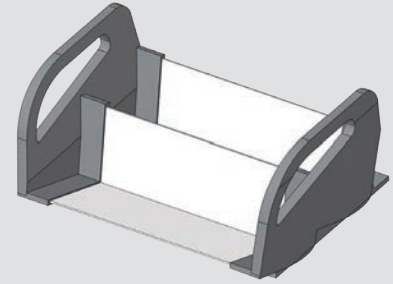

Part no.

Spice tray

**ZFZ.38G01**



### Plate holder

- Adjustable width **186 to 322** (7-5/16" to 12-11/16")
- Overall height **170** (6-11/16")
- Holds up to 12 plates
- Non-slip bottom
- High quality nylon and stainless steel

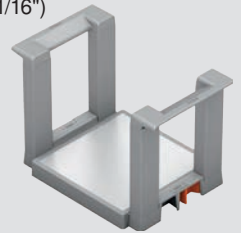

Part no.

Plate holder

**ZC7T0350**



## Trays and Dividers for ORGA-LINE

Additional trays and dividers can easily be added to customize your drawers. The high-quality stainless steel trays are very easy to clean without blemishing the material – even in the dishwasher.

### ORGA-LINE single cross divider

- Length 88 (3-7/16")
- Height 61 (2-3/8")

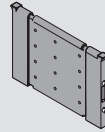

Part no.

Single cross divider

ZSI.010Q

### ORGA-LINE double cross divider

- Length 176 (7")
- Height 61 (2-3/8")

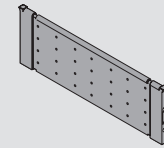

Part no.

Double cross divider

ZSI.020Q

### ORGA-LINE single tray

- Length, width 88 (3-7/16")
- Height 61 (2-3/8")

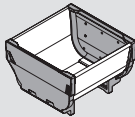

Part no.

Single tray

ZSI.010SI

### ORGA-LINE double tray

- Length 176 (7")
- Width 88 (3-7/16")
- Height 61 (2-3/8")

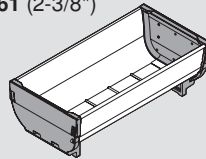

Part no.

Double tray

ZSI.020SI

### ORGA-LINE triple tray

- Length 264 (10-13/32")
- Width 88 (3-7/16")
- Height 61 (2-3/8")

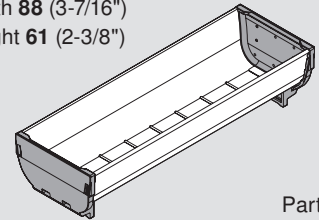

Part no.

Triple tray

ZSI.030SI





## AMBIA-LINE

Create perfect order in any drawer with AMBIA-LINE. This storage solution system, with its narrow-frame design, offers various options for organizing the interiors of your drawers with simple elegance. AMBIA-LINE inserts can be combined to suit a wide range of cabinet widths. Use a damp cloth to clean all AMBIA-LINE products.





### Uniformity

AMBIA-LINE's straight-forward design coordinates with our LEGRABOX system, providing a harmonious look and function to your drawer.



### Adjustability

The flexible cross dividers can be easily adjusted to fit the size of the items being stored. Inserts and frames can be combined as needed.



### Versatility

With the magnetic adapter plate, the frames can be positioned anywhere in the drawer; items can be clearly organized in all living areas.



### Accessories

AMBIA-LINE kitchen accessories help simplify workflows. These accessories help ensure everything is exactly where it's needed.





## AMBIA-LINE for LEGRABOX

With its reduced dimensions, AMBIA-LINE is particularly suited for LEGRABOX, the elegant box system, with straight and narrow drawer sides. Stylish and practical, AMBIA-LINE drawer organization system in Orion gray provides a clean, harmonious look and function to the interior of your drawer.





## AMBIA-LINE for Flatware

Coated with soft touch, noise-dampening material, flatware is stored almost without making a sound.

To calculate inside drawer width available:

**LEGRABOX** – Inside cabinet width - 41

### Flatware insert

- Width 300 (12")
- Height 50 (2")
- Coated with a soft touch, noise-dampening material

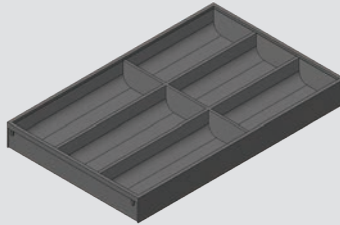

Part no.

500 (20")

ZC7S500BS3

### Flatware insert

- Width 300 (12")
- Height 50 (2")
- Coated with a soft touch, noise-dampening material

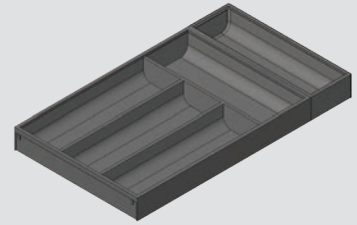

Part no.

550 (22")

ZC7S550BS3





## AMBIA-LINE for Utensils and Odds and Ends

Kitchen utensils are stored in an organized fashion to ensure everything is within easy reach. The dividers can be easily adjusted to suit the needs of your storage items. Additionally, order can be restored to the odds and ends drawer so items can be in clear view and easily accessed.

To calculate inside drawer width available:  
LEGRABOX Inside cabinet width - 41

### Narrow utensil insert

- Width 100 (4")
- Height 51 (2")

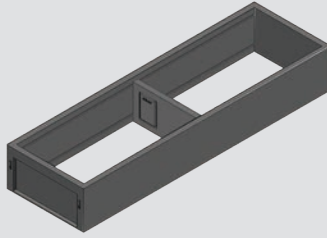

Part no.

500 (20")	ZC7S500RS1
550 (22")	ZC7S550RS1

### Wide utensil insert

- Width 200 (8")
- Height 51 (2")

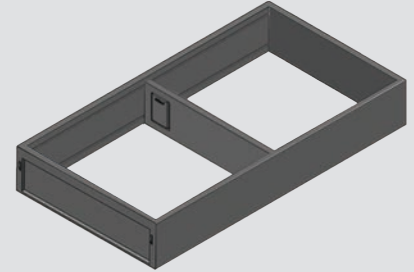

Part no.

500 (20")	ZC7S500RS2
550 (22")	ZC7S550RS2



## AMBIA-LINE for Deep Drawers

The AMBIA-LINE deep drawer insert and the cross gallery divider system is versatile, allowing you to neatly organize a variety of kitchen items, ensuring perfect organization for your drawers. For additional stability, the steel adapter plate holds the insert securely in place.

The cross gallery rail can be custom cut to fit perfectly inside each drawer and assembles tool-free to the connectors and dividers. Once assembled, lateral dividers can be adjusted side-to-side to ensure a perfect fit every time. This system is particularly suited for large storage items such as pots and pans, or for securing waste or recycling containers.

To calculate inside drawer width available:  
LEGRABOX Inside cabinet width - 41



### Deep drawer insert

- Length **370** (14-9/16")
- Width **218** (8-9/16")
- Height **111** (4-3/8")
- Includes adjustable cross divider (qty 1)
- Steel frame
- For C and F height drawers
- Magnetic back
- Non-slip rubber feet
- Order steel adapter plate separately

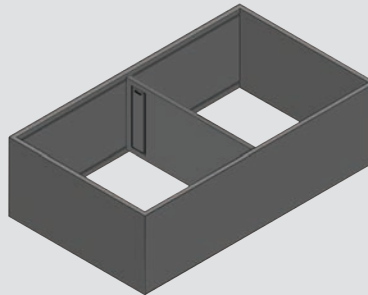

Part no.

Deep drawer insert

**ZC7F400RSP**

### Adapter plate

- Length **218** (8-9/16")
- Height **148** (5-13/16")

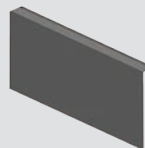

Part no.

Adapter plate

**ZC7A0P0C**

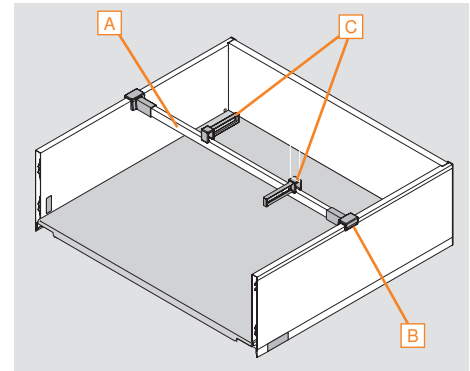

### A Cross gallery rail

- Length **1080** (42-1/2")
- Cut to size
- Orion gray or brushed nickel
- Specify color when ordering

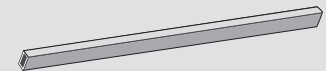

Part no.

Cross gallery rail

**ZR7.1080U**

### B Connector

- 2 required per cross rail set-up (order each separately)
- Dust gray

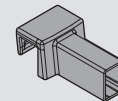

Part no.

Connector

**ZC7U10E0**

### C Lateral divider

- Dust gray

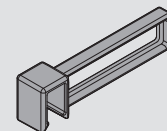

Part no.

Lateral divider

**ZC7U10F0**



## Accessories for AMBIA-LINE

**Knife holder:** Stowed away safely, but always nearby, up to 9 knives can be stored neatly in the AMBIA-LINE Knife holder.

**Spice tray:** Spices of various sizes can be neatly stored in the AMBIA-LINE Spice tray without risk of tipping over. The right spice is always in clear view and close by.

**Plate holder:** With Blum's Plate holders, storing plates in a drawer is now possible. The holder keeps the plates neatly stacked without sliding around, and makes it easy to pick up the entire stack of plates for serving.

### AMBIA-LINE Knife holder

- Length **409** (16-1/8")
- Width **187** (7-3/8")
- Height **43** (1-11/16")
- Holds 9 knives
- High quality nylon and stainless steel
- Use with wide utensil insert

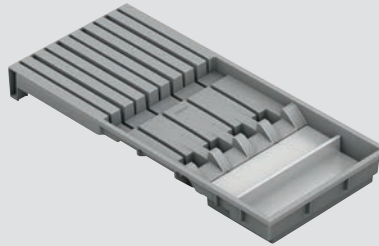

Part no.

Knife holder

**ZC7M0200**

### AMBIA-LINE Spice tray

- Length **356** (14")
- Width **200** (7-7/8")
- Height **84** (3-5/16")
- Non-slip bottom
- High quality nylon and stainless steel
- Use with deep drawer insert

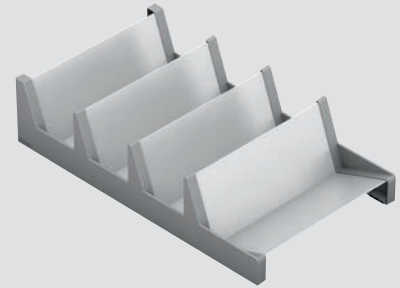

Part no.

Spice tray

**ZC7G0P01**



### Plate holder

- Adjustable width **186 to 322** (7-5/16" to 12-11/16")
- Overall height **170** (6-11/16")
- Holds up to 12 plates
- Non-slip bottom
- High quality nylon and stainless steel

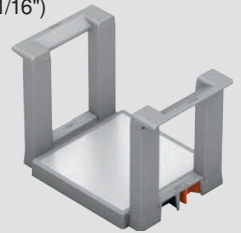

Part no.

Plate holder

**ZC7T0350**



## Dividers for AMBIA-LINE

Additional dividers can easily be added to customize your drawers. AMBIA-LINE dividers are made of high quality materials that are coated with a soft touch, noise-dampening material. Use a damp cloth to clean all AMBIA-LINE products.

### AMBIA-LINE narrow cross divider

- Length: **88** (3-1/2")
- Height: **45** (1-13/16")



Part no.

Narrow utensil insert

**ZC7Q010SS**

### AMBIA-LINE wide cross divider

- Length: **188** (7-3/8")
- Height: **45** (1-13/16")

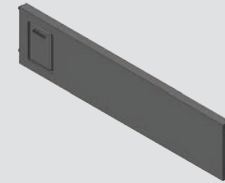

Part no.

Wide utensil insert

**ZC7Q020SS**



### AMBIA-LINE deep drawer cross divider

- Length **206** (8-1/8")
- Height **100** (3-15/16")
- For use with deep drawer insert

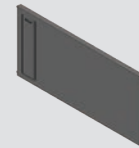

Part no.

Individual cross divider

**ZC7Q0P0FS**







## Blum's Zone Planner

Knowing how much storage space is needed allows for better planning. While all kitchens store the same basic needs, what makes each kitchen unique are the priorities and quantities of those storage items. The Zone Planner separates storage goods into five zones which allow you to consider what items you store and in what quantity.

[www.blum.com/zoneplanner](http://www.blum.com/zoneplanner)

### Plan Ahead

Based on the DYNAMIC SPACE concept, Blum's Zone Planner allows you to think about how your cabinets will function beneath the surface prior to selecting your cabinets. With this tool, ensure your new kitchen will be laid out efficiently and with plenty of storage space for the items you use most.

### Customize

All kitchen storage items are organized according to zone. Move through each zone, selecting the items you want to store in your new kitchen. Ensure there is enough space designated for your items by selecting whether you have fewer, average or more of each storage item.

### Save and Print

Save your storage list and come back to look over it later. After you have recognized what items you will need to store in your new kitchen, and in what quantity, print your results so you will be well prepared to meet with your kitchen designer and one step closer to a more efficient, comfortable kitchen.

## Connect With Us on Social Media

Be sure to connect with us on social media for additional resources for information regarding tips on installation, maximizing storage space, new products and other news and events going on inside Blum.

Find us by searching "**Blum Inc**" in the search bar.





RUSSEL  
Das Beste





**blum**<sup>®</sup>  
↑



## Quality is what our customers have come to expect from Blum

For more than 50 years, Blum has been manufacturing quality products to create motion in kitchens. With every product we strive to create new possibilities to inspire your customers in function and design.

**Blum is committed to manufacturing in the U.S.A. for the U.S.A.**

Blum produces many of its products in our manufacturing, logistics and warehouse facility located in North Carolina. Manufacturing close to our customers allows Blum to respond to changes in our customers' needs.





Blum, Inc.  
7733 Old Plank Rd.  
Stanley, NC 28164  
800-438-6788  
blum.com

