

ASSA ABLOY

Experience a safer
and more open world

D And E Series SFIC Management Control Deadbolt



D And E Series SFIC Management Control Deadbolt



ASSA ABLOY

PROFESSIONAL REPLACEMENT PRODUCTS

The Arrow Management Control Deadbolt gives facility managers control on deadbolt installation and removal with our concealed mounting screws technology.

The Arrow Management Control Deadbolt requires an operational control key in order to access the deadbolt attachment screws as illustrated below.

This product is ideal for use in multifamily housing applications including apartments, dormitories and military.

See the D and E series catalog for available options and parts.

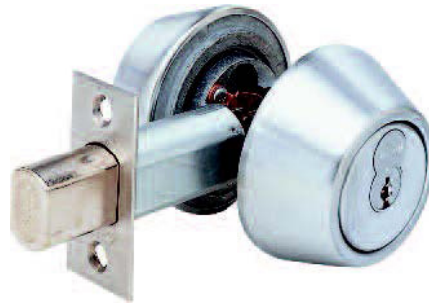

D62IC Grade 1
Double Cylinder



D71IC Grade 1
Single Cylinder



E62IC Grade 2
Double Cylinder



E71IC Grade 2
Single Cylinder

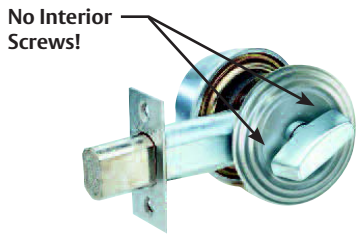

Inside View

HOW TO REMOVE THE DEADBOLT

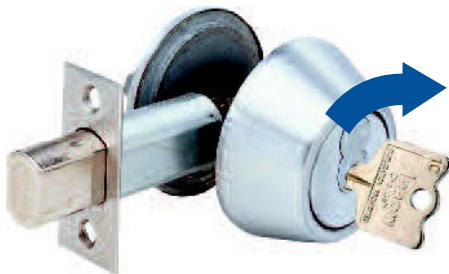

Step 1 – Use the Control Key and Rotate the Cylinder.

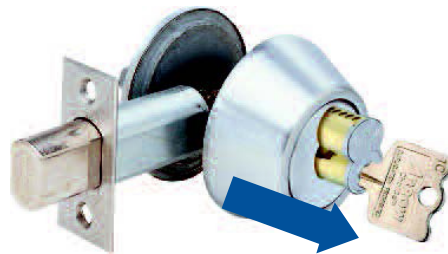

Step 2 – Remove the SFIC Cylinder.

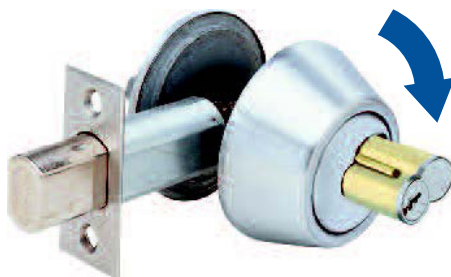

Step 3 – Using the end of the Cylinder rotate the face plate 90 Degrees.



Step 4 – Remove the Screw, Rotate the Plate 180 Degrees and Remove the other Screw. You may now remove the deadbolt.

WARNING

This product can expose you to lead which is known to the state of California to cause cancer and birth defects or other reproductive harm. For more information go to www.P65warnings.ca.gov.



ASSA ABLOY

Experience a safer
and more open world

Cylinders



Table of Contents

ASSA ABLOY

Cylinders.....	3
Housings.....	4
Arrow Pointe Flex	5
Arrow Pointe	6
Arrow Pointe Sliding Door Core.....	7
Arrow SFIC Cam Locks	8

 **WARNING**

This product can expose you to lead which is known to the state of California to cause cancer and birth defects or other reproductive harm. For more information go to www.P65warnings.ca.gov.

Cylinders

Mortise Cylinders:

General Specifications:

- **Body** – Brass, 1-5/32" (29.37mm) diameter. Six pin tumbler cylinder.
- **Furnished** – Standard with cylinder collar.
- **Length** – 1-1/8" (28.57mm), 1-1/4" (31.75mm), 1-1/2" (38mm), 2" (51mm).
- **Scalp** – Brass, Bronze, Stainless steel.
- **Keyway** – "A" keyway standard. Arrow sectional keyways available. Optional Schlage C keyway available.
- **Finish** – US3, US4, US10, US10B, US32, US32D.



Rim Cylinders:

General Specifications:

- **Body** – Brass, 1-5/32" (29.37mm) diameter. Six pin cylinder.
- **Furnished** – With back plate, 2 Screws (2" door max.), tailpiece and cylinder collar.
- **Scalp** – Brass, Bronze, Stainless steel.
- **Keyway** – "A" keyway standard. Arrow sectional keyways available. Optional Schlage C keyway available.
- **Finish** – US3, US4, US10, US10B, US32, US32D.



Cylindrical Lock Cylinders:

General Specifications:

- **Body** – Solid brass pin tumbler 6 chambers. Pinned 5 for Grade 2 Locksets. Pinned 6 for Grade 1 locksets.
- **Keyway** – "A" keyway standard. Arrow sectional keyways available. Optional Schlage C keyway available.
- **Finish** – US4, US26D.

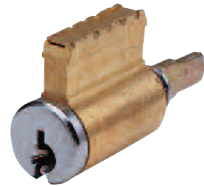

Deadlock Cylinders:

General Specifications:

- **Body** – Solid brass pin tumbler, 6 chambers for E&D series deadlocks. E series pinned 5. D series pinned 6.
- **Keyway** – "A" keyway standard. Arrow sectional keyways available. Optional Schlage C keyway available.
- **Finish** – US4, US26D.

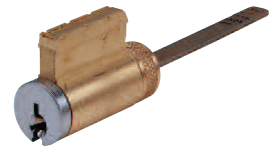

Mortise Cylinder Cams:

- Screw on cams for Plus IC Housings



001



AM2



004



006



AR18

Cat No.	Functions & Application
001	12, 17, 22, 23, 24, 27, 32 I/S, 33, 37
AM2	11, 13, 15, 16, 19, 20, 21, 31, 32 O/S, 34, 38, 41, 42, 44
004	N Series, Exit Devices, Exit Alarms
006	Schlage®
AR18	Adams Rite

Product Line	BMX	CL	D	E	GL	MK	96C-DBX9
Cylinder	MC61-001 ¹ MC61-AM2 ²	100YC	692C ⁵ 692DC ⁶	96C ⁵ 96DC ⁶ 100 ⁷ 100DC ⁸	600HD-GL	100C ³ 100C-750 ⁴	96C-DBX ⁹ 96C-CS-DBX ¹⁰ 96DC-DBX ¹¹ 96DC-CS-DBX ¹²

Product Line	N	RK	RL	RLX, MLX, QL, HK, SRX
Cylinder	MC61-004	100C-RK	600HD	C700HD ¹³ C700HD-CS ¹⁴

1. For BMX mortise functions 12, 17, 22
 2. For BMX mortise functions 11, 19, 20
 3. For MK with "T" or "D" knob
 4. For MK with "B" knob
 5. For D/E single cylinder function, except E41
 6. For D/E double cylinder function, except E42
 7. For E41 single cylinder function
 8. For E42 double cylinder function
 9. For DBX single cylinder function, AR keyway, Keyed Different only
 10. For DBX single cylinder function, Schlage C keyway, Keyed Different only
 11. For DBX double cylinder function, AR keyway, Keyed Different only
 12. For DBX double cylinder function, Schlage C keyway, Keyed Different only
 13. For AR keyway, Keyed Different only
 14. For Schlage C keyway, Keyed Different only

Housings

Mortise Cylinder Housings:

- **Body** – Brass, 1-5/32" diameter
- **Furnished** – with cam, cylinder collar
- **Length** – 1-1/8" 6 pin only; 1-1/4" 6 or 7 pin

Mortise SFIC Housing Cams:

- Staked cams for standard mortise cylinder housing



16CR-001 16CR-AM2 16CR-004 16CR-006 16CR-AR18

Cat No.	Functions & Application
16CR-001	12, 17, 22, 23, 24, 27, 32 I/S, 33, 37
16CR-AM2	11, 13, 15, 16, 19, 20, 21, 31, 32 O/S, 34, 38, 41, 42, 44
16CR-004	N Series, Exit Device, Exit Alarms
16CR-006	Schlage®
16CR-AR18	Adams Rite

Mortise Cylinder Housing



16CR-16x (Cam)

Tapered Mortise Cylinder Housing



16CRT-16xAR18

Rim Cylinder Housing



16RCR-16

Rear Staked on Cam



16CR-16xAM2

IC Housings:

Mortise Housings

Description (16CR-001 cam supplied unless otherwise specified)		Part No.
6-pin housings, 1-1/8"	Standard	16CR-16X (cam)
	Tapered	16CRT-16XAR18
7-pin housings, 1-1/4"	Standard	16CR-27X (cam)
	Tapered	16CRT-27XAR18

Rim Cylinder Housing:

- **Body** – Brass, 1-5/32" diameter; 6 or 7 pin tumbler
- **Furnished** – with backplate, cylinder collar 2 screws, tailpiece

Rim Housings

Cylinders	Part No.
6-pin housing	16CR-16X (cam)
7-pin housing	16CRT-16XAR18

Plus Housings:

Mortise Housings

Description (16CR-001 cam supplied unless otherwise specified)		Part No.
6-pin housings, 1-1/8"	Standard	16CR-16X (cam)
	Tapered	16CRT-16XAR18
7-pin housings, 1-1/4"	Standard	16CR-27X (cam)
	Tapered	16CRT-27XAR18



Front Plus Housing
C16CR-27x (Cam)



Rear Plus Housing Screw-on Cam
C16CR-27x001

Rim Housings

Cylinders	Part No.
6-pin housing	C16RCR-16
7-pin housing	C16RCR-27

Spacers:

Cat No.	Description
16CR-123-1	1/8" Spacer - Blocking Ring
16CR-123-2	1/4" Spacer - Blocking Ring
16CR-123-3	3/8" Spacer - Blocking Ring
16-113A	Cylinder Collar & Spring

1/8" Spacer



16CR-123-1

1/4" Spacer



16CR-123-2

3/8" Spacer



16CR-123-3

Collar & Spring

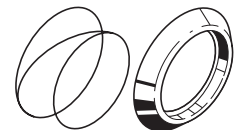

16-113A

Arrow Pointe Flex

ASSA ABLOY

The Pointe Flex System offers a totally new concept in interchangeable core key control. The system employs a unique core security feature and patented key design. The unique feature is the pin assembly which runs through the center of the core keyway preventing standard competitive interchangeable core keys from entering the lock cylinder. Only the patented Pointe Flex key can operate locks with the Pointe Flex cylinder. All keyways are restricted and will be issued on a contractual basis, determined by geographical availability. Pointe Flex enables you to create a high/low system, by incorporating core with and without the pin assembly, greatly enhancing flexibility.



7 Pin interchangeable core & patented key



Pointe Flex Key Blanks:

Nickel Silver

CAT NO.	DESCRIPTION
CHX x Keyway	6 or 7 Pin Key Blank, with hole in blade
CH x Keyway	6 or 7 Pin Key Blank without hole in blade

* Dualevel Masterkeying Capabilities.

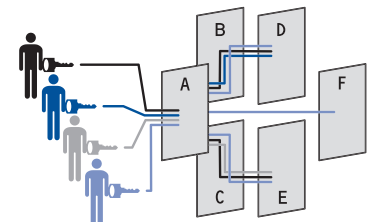

† Door "F" uses Flexcore within masterkey system.

- Maintenance (A, B, C, D, E)
- Supervisor A (A, B, D)
- Supervisor B (A, C, E)
- General Manager (All doors)†

Features:

- Available 6 and 7 pin
- Solid brass construction
- Reinforced sleeve design
- Combined or Uncombined
- US26D or US4 finish

Arrow Keyways:

Restricted keyways—consult factory for availability.

CAT NO.	DESCRIPTION
X1CR	6 Pin Core Combined
X71CR	7 Pin Core Combined
X1CR-UC	6 Pin Core Uncombined
X71CR-UC	7 Pin Core Uncombined

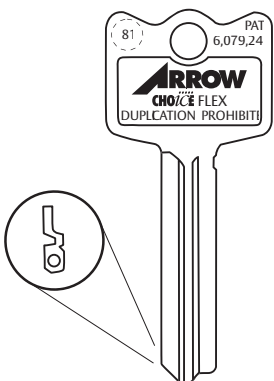

Arrow Pointe

Arrow Pointe interchangeable core products offer dealers unlimited flexibility and keying options. Available in standard 6 and 7 pin format in Arrow and competitive keyways, dealers can install Arrow Pointe in new or existing key systems. Arrow's unique manufacturing process gives Arrow Pointe interchangeable cores unmatched strength and durability. The core features four main components: the plug, shell, sleeve and faceplate. Our precision engineering design, keying capability and availability make Arrow Pointe interchangeable cores our most specified brand for commercial, industrial and institutional applications.

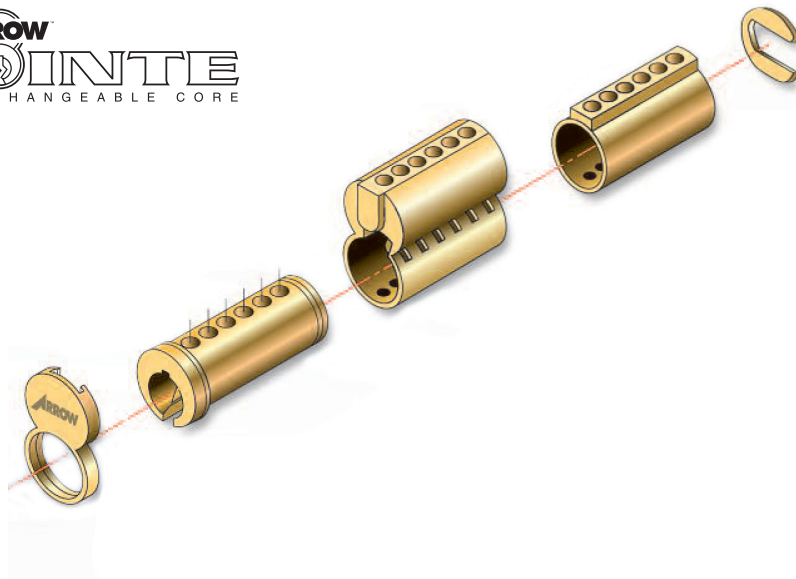

ASSA ABLOY

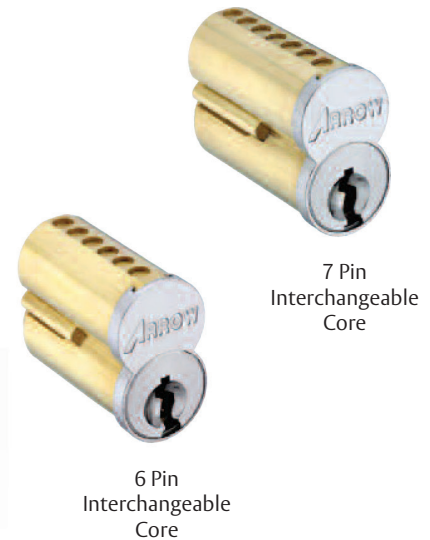

Features:

- Solid Brass Construction
- Reinforced Sleeve Design
- Combined or Uncombined
- US26D or US4 finish

Arrow Keyways:

- 1C & 1D Standard
- Competitive Keyways Available
- Restricted Keyways Available — Consult Factory

Arrow & Competitor Keyways:

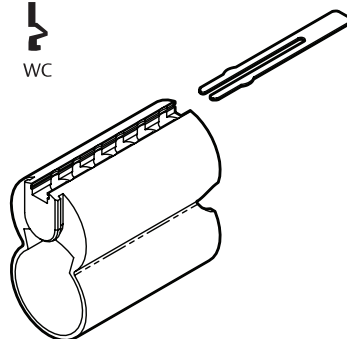
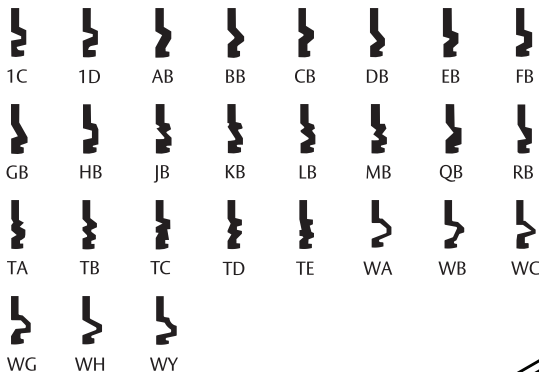

CAT NO.	DESCRIPTION
100CR	6 Pin Combined Core
100CR-UC	6 Pin Uncombined Core
7100CR	7 Pin Combined Core
7100CR-UC	7 Pin Uncombined Core
C x Keyway	6/7 Pin Key Blank

SFIC Cores With Alternate Slide Cover

CAT NO.	DESCRIPTION
100SR	6 Pin Combined Core
100SR-UC	6 Pin Uncombined Core
7100SR	7 Pin Combined Core
7100SR-UC	7 Pin Uncombined Core

Arrow Pointe Sliding Door Core

ASSA ABLOY

The Sliding Door Core is an addition to the Arrow Pointe SFIC Pointe product line, the SD series. This core is used to retrofit existing sliding door housings such as the Best® 4S73 and Olympus Lock® 723S sliding door cylinder housing.

This style core is used in conjunction with housings designed to work in display cabinets and storage areas using sliding door panels to secure valuables behind glass panels and doors made of other building materials.

Our precision engineering design, keying capability and availability make Arrow Pointe interchangeable cores our most specified brand for commercial, industrial and institutional applications.



7 Pin
Pointe Sliding Door
Interchangeable Core



Arrow & Competitor Keyways:

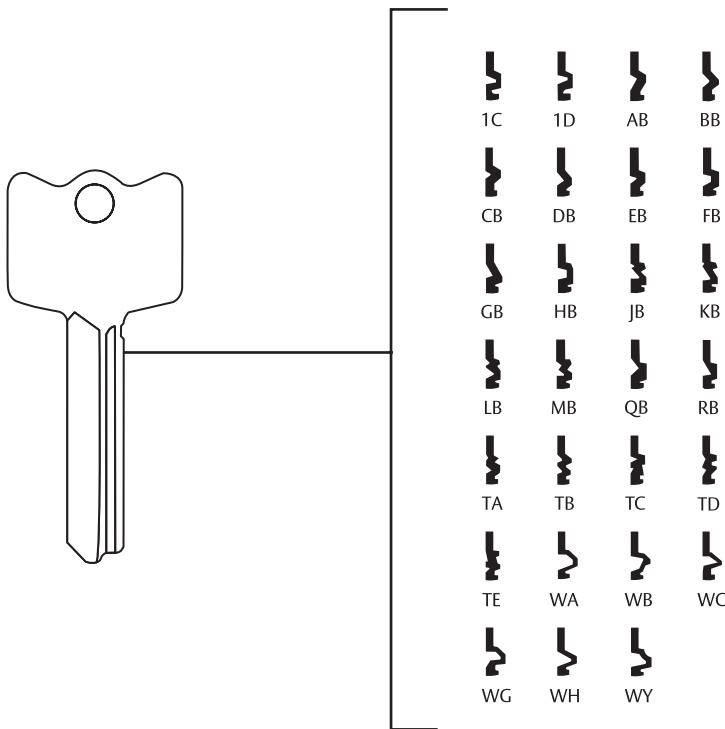

Features:

- Reinforced Sleeve Design
- Barrell Cap Design
- Solid Brass Construction

Finishes:

US26D & US4 finishes.

Pinning:

7 Pin: SD7100CR x Keyway — Combined & Uncombined.

Arrow Keyways:

1C & 1D Standard keyways or unpublished restricted keyways available — consult factory for availability.

Pointe Key Blanks:

Nickel Silver

CAT NO.	DESCRIPTION
C x Keyway	7 Pin Key Blank

Competitive Keyways:

AB, BB, CB, DB, EB, FB, GB, HB, JB, KB, LB, MB, QB, RB, TA, TB, TC, TD, TE, WA, WB, WC, WG, WH, WY

Arrow SFIC Cam Locks

ASSA ABLOY

The Arrow SFIC keyway Cam Locks offer a retrofit option for keying into existing SFIC system with a 3/4" cylinder. The Arrow Cam Locks are available in all of the Arrow (with the exception of Flex) and the most popular competitor keyways, providing a wide selection for almost any retrofit application.

The Arrow cam locks are ideal for use on cabinets, desks, elevators, alarm panels or other applications to secure valuable data or information.

Our precision engineering and design, keying capabilities and availability make the Arrow Cam Locks an ideal solution for commercial, industrial and institutional applications.

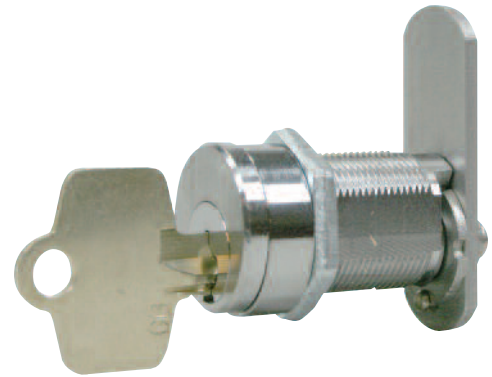

Arrow SFIC Keyway Cam Lock

Features:

- Fits any standard 3/4" Double D Hole (Double DWasher included for round hole mounting.)
- Typical uses include drawers, cabinets, secure enclosures, retail fixtures, vending equipment, medical carts and storage, utility boxes
- Cam motion operation — 90 degree, Clockwise or Counterclockwise, Locked Position at 3, 6, 9, or 12 o'clock
- Key motion operation — 90 degree captive (KR), 360 degree non-captive (NKR)

Finishes:

US26D (626)

Standard Kit Includes:

- Sub-assembled cam lock (Plug, Shell, Retainer)
- 90° Stop
- Straight cam
- Offset cam
- 360° Drive Plate (NKR)
- 90° Drive Plate (KR)
- Drive pin
- 2 Plate screws
- Hex nut
- Double D Mounting Washer
- 1/4" spacer

Available Spacers:

1/16", 1/8", 3/16", 1/4" (included in kit), 5/16", 3/8", 7/16"

How To Order:

Sub-Assembled Kit – CLK-10-(Specify Keyway).26D.
Assembled Units – CLK-11- (Specify Keyway).26D*.

Example: CLK-10-1D.26D.

*Standard keying is KD. KA keying also available. Factory master-keyed orders are subject to standard keying charges.

Model CLK-11 is shown.

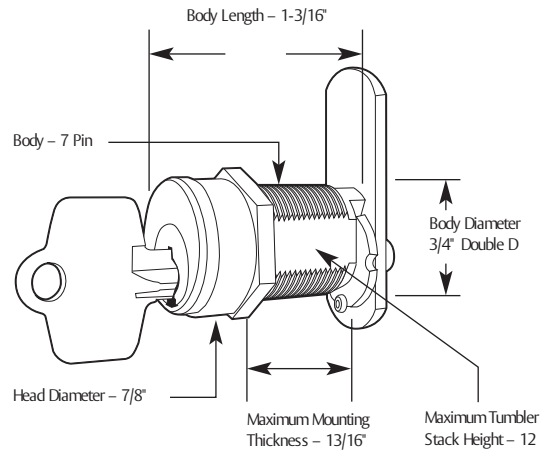

Arrow & Competitor Keyways:

1C & 1D Standard keyways or unpublished restricted keyways available — consult factory for availability.

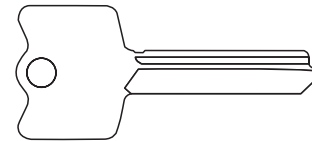

1C	1D	AB	BB	CB	DB	EB
FB	GB	HB	JB	KB	LB	MB
QB	RB	TA	TB	TC	TD	TE
WA	WB	WC	WG	WH	WY	



Notes

ASSA ABLOY

The ASSA ABLOY Group is the global leader in access solutions. Every day, we help billions of people experience a more open world.

ASSA ABLOY Opening Solutions leads the development within door openings and products for access solutions in homes, businesses and institutions. Our offering includes doors, frames, door and window hardware, mechanical and smart locks, access control and service.



ASSA ABLOY

Arrow Lock & Door Hardware
225 Episcopal Road
Berlin, CT 06037
Customer Service: 1-800-327-8539
Technical Product Support: 1-800-327-8539 X2
www.arrowlock.com

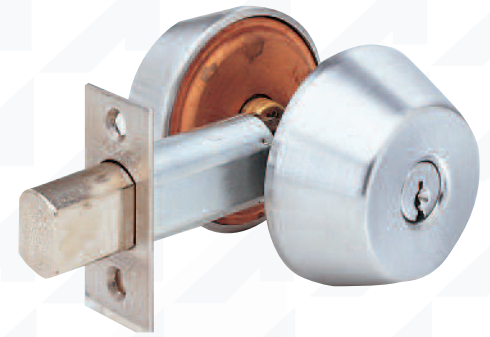

ASSA ABLOY

Experience a safer
and more open world

D Series Deadbolt



D Series Deadbolts



PREMIER PRODUCT

ASSA ABLOY

General Specs:

- **Housing** – Two-piece housing, with free-spinning outer ring to prevent wrenching. Concealed mounting screws are standard on double cylinder functions.
- **Deadbolt** – 1" (25.40mm) throw, solid steel deadbolt with hardened, free spinning, steel pin insert.
- **Backset** – 2-3/8" (60.32mm), 2-3/4" (69.85mm).
- **Deadbolt fronts** – 2-1/4" (57.15mm) x 1" (25.40mm) standard for 2-3/8" (60.32mm) backset, 2-1/4" (57.15mm) x 1-1/8" (28.57mm) standard for 2-3/4" (69.85mm) backset. Drive-in deadbolts are available.
- **Doors** – 1-3/8" (34.925mm) to 1-3/4" (44.45mm) thick standard. Thick door kits available up to 2-1/4" (57mm).
- **Strikes** – Supplied standard with #395 strike kit. (Includes #346 metal frame strike and #345 wood frame strike).
- **Handing** – All functions are reversible.
- **Cylinder** – Standard: Solid brass, 6-pin cylinder. Supplied with two nickel silver keys.
Options: Arrow A or sectional keyways, Schlage® C keyway, master keying, prep for small format interchangeable core cylinder (cylinder not included).

Arrow D Series deadlocks are engineered to perform under the most extreme conditions where security is critical. Our Grade 1 extra heavy duty deadlock surpasses the demands of industrial, institutional and commercial applications.

Certification & Compliance:



- ANSI/BHMA A156.36 - 2020 Auxiliary Locks, Grade 1
- Underwriters Laboratories (UL and CUL) listed for use on 20 minute fire doors when used in conjunction with a rated primary latching device

Finishes:

BHMA	U.S. Equivalent	Arrow Code	Finish Description	
605	US3	03	Bright Brass	
606	US4	04	Satin Brass	
609	US5	05A	Antique Brass	
612	US10	10	Satin Bronze	
613	US10B	10B	Dark Oxide Bronze, Oil Rubbed	

BHMA	U.S. Equivalent	Arrow Code	Finish Description	
613E	613E	US10BE	Dark Oxide Bronze, Equivalent	
625	US26	26	Bright Chromium Plated	
626	US26D	26D	Satin Chromium Plated	
—	—	BSP	Black Suede Powder Coat	

WARNING

This product can expose you to lead which is known to the state of California to cause cancer and birth defects or other reproductive harm. For more information go to www.P65warnings.ca.gov.

D Series Deadbolts

PREMIER PRODUCT

ASSA ABLOY

Deadbolts:

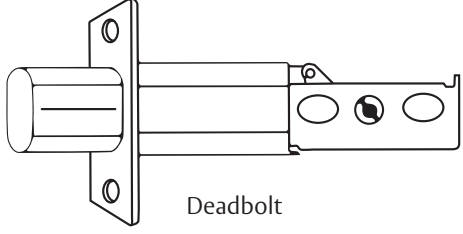
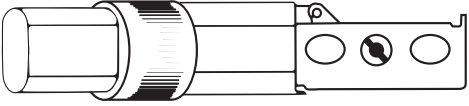
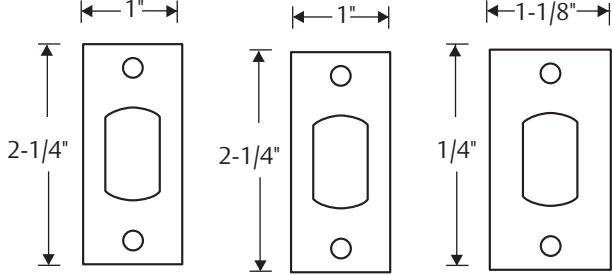
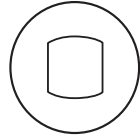
 <p>Deadbolt</p>	 <p>Drive-In Deadbolt</p>
 <p>Part No. #141 #142 #144 Backset 2-3/8" 2-3/4" 2-3/4"</p>	 <p>#145 #146 2-3/8" 2-3/4"</p>

Strikes:

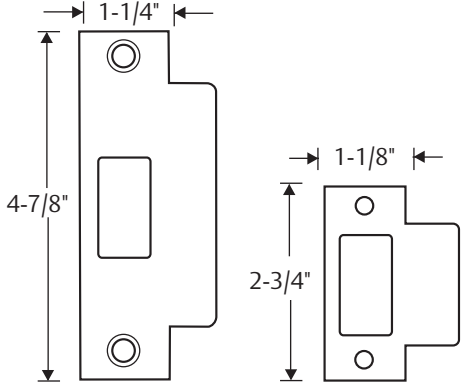
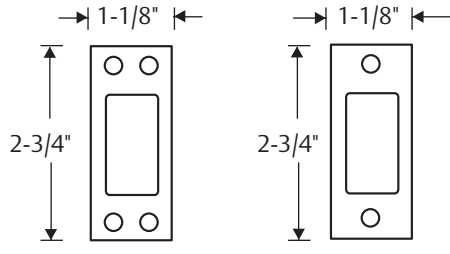
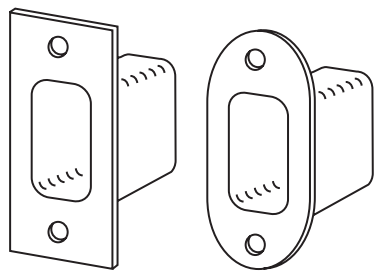
 <p>#347 ASA</p> <p>#350 T</p>	 <p>#345 (for wood doors)</p> <p>#346 (for metal doors)</p>	 <p>BX91D (D Series)</p> <p>BX91 (E Series)</p>
--	---	--

Parts:

Thick Door Pack – For doors 2-1/4" thick

D Series Deadbolts



PREMIER PRODUCT

ASSA ABLOY

D, E, DBX Series Deadbolts:

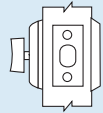
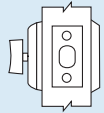
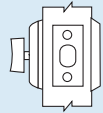
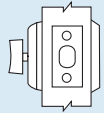
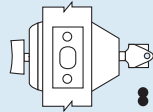
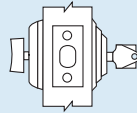
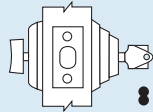
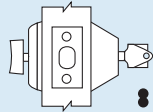
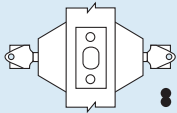
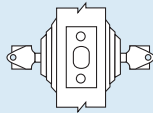
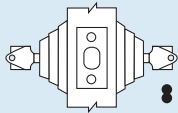
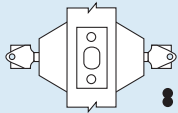
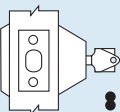
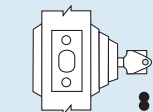
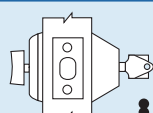
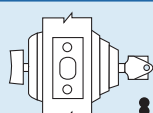
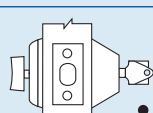
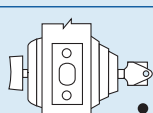
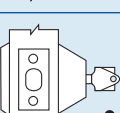
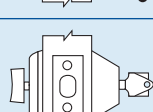
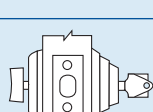
GRADE 1			GRADE 2			FUNCTION	OPERATION	
ARROW CODE	BHMA		ARROW CODE	BHMA			INSIDE	OUTSIDE
D60	E0111		E60	E0112		Exit	Turnpiece Retracts & Projects Bolt	Blank Plate
D61	E0151		E41	E0152		Single Cylinder	Turnpiece Retracts & Projects Bolt	Key Retracts & Projects Bolt
			E61					
			DBX61					
D62	E0141		E42	E0142		Double Cylinder	Key Retracts & Projects Bolt	Key Retracts & Projects Bolt
			E62					
			DBX62					
D63	E0161		E63	E0162		Single Cylinder	Blank Plate	Key Retracts & Projects Bolt
D64	E0171		E64	E0172		Classroom	Turnpiece Retracts Bolt But Does Not Project Bolt	Key Retracts & Projects Bolt
D71-IC	E0151		E71-IC	E0152		Single Cylinder With Concealed Mounting Screws (IC Only)	Turnpiece Retracts & Projects Bolt	Key Retracts & Projects Bolt
D73-IC	E0161		—	—	—	Single Cylinder With Concealed Mounting Screws (IC Only)	Blank Plate	Key Retracts & Projects Bolt
D74-IC	E0171		E74-IC	E0172		Classroom With Concealed Mounting Screws (IC Only)	Turnpiece Retracts Bolt But Does Not Project Bolt	Key Retracts & Projects Bolt

D Series Deadbolts



PREMIER PRODUCT

ASSA ABLOY

How To Order:

How to Order D Series Deadbolt:

Example: To order a D Series Single Cylinder Deadbolt, Satin Chromium Plated finish, 1-1/8" x 2-3/4" square corner two-hole metal strike, a 2-3/4" backset with 1-1/8" square corner latch, AR cylinder keyway, keyed different.

Specify:

Series	Function	Finish	Strike	Bolt	Cylinder Keyway	Keying Cylinder
D	61	26D	346	144	AR	KD

The ASSA ABLOY Group is the global leader in access solutions. Every day, we help billions of people experience a more open world.

ASSA ABLOY Opening Solutions leads the development within door openings and products for access solutions in homes, businesses and institutions. Our offering includes doors, frames, door and window hardware, mechanical and smart locks, access control and service.



ASSA ABLOY

Arrow Lock & Door Hardware
225 Episcopal Road
Berlin, CT 06037
Customer Service: 1-800-327-8539
Technical Product Support: 1-800-327-8539 X2
www.arrowlock.com



ASSA ABLOY

Experience a safer
and more open world



RL Series Cylindrical Lever Locks



Features:

Construction – Cold rolled steel with zinc dichromate finish for corrosion resistance. Requires standard 2-1/8" (54mm) bore through door.

Backset – 2-3/8" (60mm) or 2-3/4" (70mm)

Door Thickness – Fits 1-3/8" (35mm) to 1-3/4" (44mm) doors standard.

Latch – Brass 1/2" (13mm) throw, UL Listed, guarded latchbolt on all locking functions

Latch Front – 1" x 2-1/4" (25mm x 57mm) for 2-3/8" backset (60mm) or 1-1/8" x 2-1/4" for 2-3/4" (70mm) backset.

Exposed Trim – RL Levers are pressure cast zinc measuring 4-3/4" (121mm) in length. RL Roses are wrought brass 3-3/8" (86mm) diameter. Total projection from face of door is 2-1/2" (64mm).

Strike – 4-7/8" ANSI (124mm), 2-3/4" (70mm) T strike, or 2-1/4" (57mm) full lip strike.

Cylinder – RL Series locksets are supplied standard with solid brass 6-pin cylinders pinned in all 6 chambers with two keys. The Arrow AR keyway is standard with optional keyways, the Arrow sectional keyways and Schlage Cs keyway. Keyed different is the standard with keyed alike, O-bit, and master keying available. Optional: Interchangeable core – lockset prepared for use with 6 or 7 pin interchangeable core. Supplied less core but packed with 6 and 7 pin tailpieces. Suffix "IC" to request Small Format Interchangeable Core prep.

Handing – Non-handed

Thru-bolts – Removable thru-bolts standard on RL Series

Packaging – 10 per case

Warranty – Five Year Mechanical Warranty

The RL Series has been enhanced to offer removable throughbolts and a wide variety of designs, finishes and functions. The RL Series cylindrical locksets are an economical value for a variety of application. Perfect for multi-family housing markets, as well as light commercial applications.

ADA/Americans with Disabilities Act:

Acceptable Door Hardware: Section 4.13.9

Handles, pulls, latches and other operating devices on accessible doors shall have a shape that is easy to grasp with one hand and does not require grasping, tight pinching or twisting of the wrist to operate. Lever operated mechanisms, push-type mechanisms and "U" shaped handles are acceptable designs.



Look for the universal symbol next to Arrow products that comply with ADA accessibility requirements.

Certification & Compliance:



The RL Series has been designed to meet the requirements of ANSI, A156.2, Series 4000, Grade 2 UL Listed for use on 3 hour, A label single swinging doors.

RL Levers conform to ADA requirements.

Finishes:

Arrow Code	BHMA	U.S. Equiv.	Finish Description	
605	605	US3	Bright Brass	
606	606	US4	Satin Brass	
6 13E	6 13E	US10BE	Dark Oxidized Satin Bronze Equivalent	

Arrow Code	BHMA	U.S. Equiv.	Finish Description	
625	613	US26	Bright Chromium Plated	
626	626	US26D	Satin Chromium Plated	
BSP	BSP	—	Black Suede Powder Coat	

WARNING

This product can expose you to lead which is known to the state of California to cause cancer and birth defects or other reproductive harm. For more information go to www.P65warnings.ca.gov.

RL Series Cylindrical Lever Locks

Design:

Sierra - SR

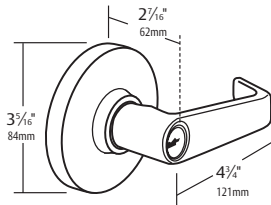

Broadway - BRR

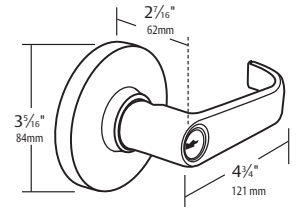

TR

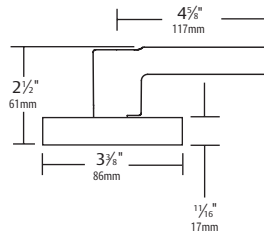

Interchangeable Core:

- Look for these symbols to indicate when product is available in either large or small format interchangeable core.

Cylinders:

Solid Brass 6 pin cylinder pinned 5 for RK, pinned 6 for RL. "A" Keyway standard. Arrow sectional keyways available. US4, US26D finish.

Tailpieces:

Part #	Series
1001-44	RL Series
550RK-44	RK Series



Cylinder Part
 #100C-RK – RK Series
 #600HD – RL Series



This product can expose you to lead which is known to the state of California to cause cancer and birth defects or other reproductive harm. For more information go to www.P65warnings.ca.gov.

RL Series Cylindrical Lever Locks



ASSA ABLOY

Functions:

ARROW STANDARD	FUNCTION		DESCRIPTION
RL01	Passage		Latchbolt operated by lever either side.
RL02	Privacy		Latch operated by lever either side except when outside lever is locked by pushing inside button. Outside lever unlocked by turning inside lever, using emergency key, or closing door. Inside lever always operates latch.
RL03	Communicating		Latchbolt by inside lever only. Blank rose only outside.
RL08	1/2 Dummy Trim		Rigid trim for one side of door only. Used as pull or to match active trim.
RL11	Entrance		Latchbolt operated by lever either side except when outside lever is locked by turn-button inside. When outside lever is locked, latchbolt operated by key outside or turning inside lever. Inside button must be manually released.
RL12	Storeroom		Outside lever always rigid. Latchbolt operated by key in outside lever, or by turning inside lever.
RL17	Classroom		Latchbolt operated by lever either side except when key outside locks outside lever. Inside lever always free. Key outside locks/unlocks outside lever only.



Indicates lever rigid at all times.

Latches & Strikes:

Latch Standards	UL Spring Latches	UL Dead Latches	Drive-In Latches	
2-3/8" Backset	 #R72	 #R70	 #R74 Deadlatch	 #R76 Springlatch
2-3/4" Backset	 #R73	 #R71	 #R75 Deadlatch	 #R77 Springlatch

Accessories:

Strikes:

R62 Strike
Standard with
RL Series

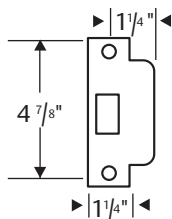

ASA
ANSI 115.2

R60 Strike
Standard with
RK Series

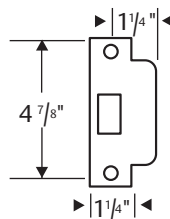

T
ANSI 115.3

R61 Strike

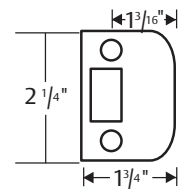

Installation:

161 prep for retrofit and secure installation.

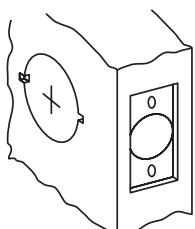

Ordering Example:

Example: To order a RL Series entry function lockset with a Sierra lever design, satin chrome finish, with a R71 strike, and 2-3/4" deadlocking latch, keyed different:

Specify:

Standard:

Series	Function	Design	Finish	Strike	Latch	Keying	Options (if required)
RL	11	SR	26D	R62	R71	KD	XXX

The ASSA ABLOY Group is the global leader in access solutions. Every day, we help billions of people experience a more open world.

ASSA ABLOY Opening Solutions leads the development within door openings and products for access solutions in homes, businesses and institutions. Our offering includes doors, frames, door and window hardware, mechanical and smart locks, access control and service.



ASSA ABLOY

Arrow Lock & Door Hardware
225 Episcopal Road
Berlin, CT 06037
Customer Service: 1-800-327-8539
Technical Product Support: 1-800-327-8539 X2
www.arrowlock.com



ASSA ABLOY

Experience a safer
and more open world

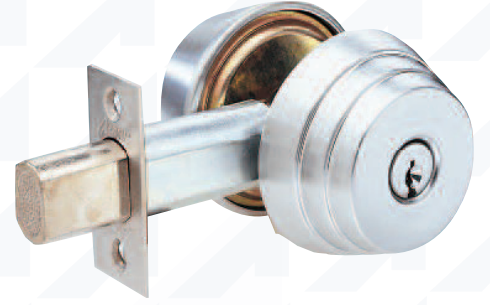

E Series Deadbolt



CLASSIC PRODUCT

ASSA ABLOY

General Specs:

- **Housing** – Two-piece housing, with free spinning outer ring to prevent wrenching. Concealed mounting screws standard on double cylinder functions.
- **Thru-bolting** – supplied with two 1/4" (6.35mm) steel thru-bolts.
- **Deadbolt** – 1" (25.40mm) throw, solid steel deadbolt with hardened, free spinning, steel pin insert.
- **Backset** – 2-3/8" (60.32mm), 2-3/4" (69.85mm)
- **Deadbolt Fronts** – 2-1/4" (57.15mm) x 1" (25.40mm) standard for 2-3/8" (60.32mm) backset, 2-1/4" (57.15mm) x 1-1/8" (28.57mm) standard for 2-3/4" (69.85mm) backset. Drive-in deadbolts are available.
- **Doors** – 1-3/8" (34.925mm) to 1-3/4" (44.45mm) thick standard. Thick door kits available up to 2-1/4" (57mm).
- **Strikes** – Supplied standard with the #395 strike kit. (Includes #346 metal frame strike and #345 wood frame strike).
- **Handing** – All functions are reversible.
- **Cylinder** – Standard: Solid brass, 6-pin, pinned 5, 2 brass keys
Options: Arrow A or sectional keyways, Schlage® C keyway, master keying, prep for small format interchangeable core cylinder (cylinder not included).
E41 and E42 low profile deadbolts are supplied with 5-pin cylinders with two brass keys. Arrow A and Schlage® C keyways only, keyed different or keyed alike four.

Arrow E Series deadlocks are unsurpassed for value, quality and durability. Our tamper resistant rotating wrench-proof collar, steel deadbolt with hardened steel pin insert and concealed screws are security features that have made the E Series the most specified deadlock in its class.

Certification & Compliance:



- ANSI/BHMA A156.36 - 2020, Auxiliary Locks, Grade 2
- Underwriters Laboratories (UL and CUL) listed for use on 3 hour fire doors when used in conjunction with a rated primary latching device.

Finishes:

BHMA	U.S. Equivalent	Arrow Code	Finish Description	
605	US3	03	Bright Brass	
606	US4	04	Satin Brass	
609	US5	05A	Antique Brass	
612	US10	10	Satin Bronze	
613	US10B	10B	Dark Oxide Bronze, Oil Rubbed	

BHMA	U.S. Equivalent	Arrow Code	Finish Description	
613E	613E	US10BE	Dark Oxide Bronze, Equivalent	
619	US15	15	Nickel Plated	
625	US26	26	Bright Chromium Plated	
626	US26D	26D	Satin Chromium Plated	
—	—	BSP	Black Suede Powder Coat	

WARNING

This product can expose you to lead which is known to the state of California to cause cancer and birth defects or other reproductive harm. For more information go to www.P65warnings.ca.gov.

E Series Deadbolts

CLASSIC PRODUCT

ASSA ABLOY

Deadbolts:

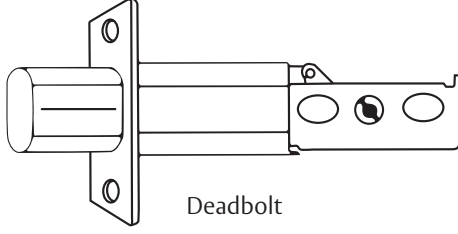
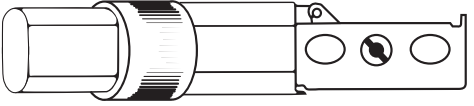
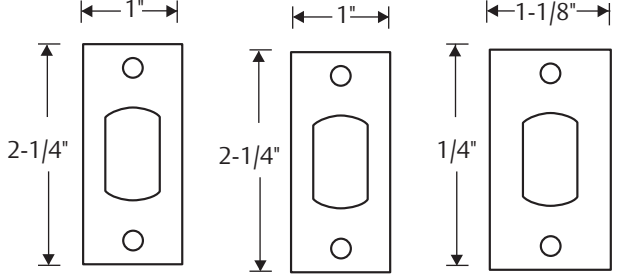
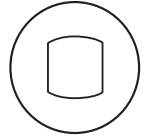
 <p>Deadbolt</p>	 <p>Drive-In Deadbolt</p>
 <p>Part No. #141 #142 #144 Backset 2-3/8" 2-3/4" 2-3/4"</p>	 <p>#145 #146 2-3/8" 2-3/4"</p>

Strikes:

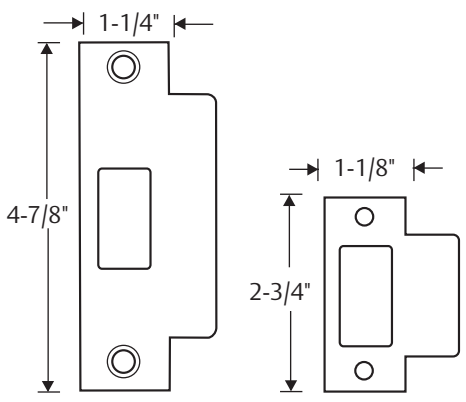
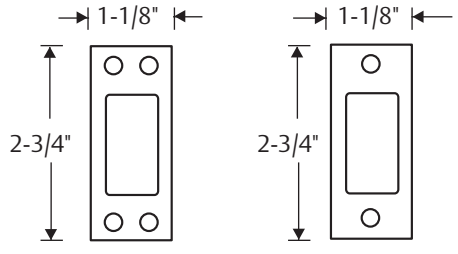
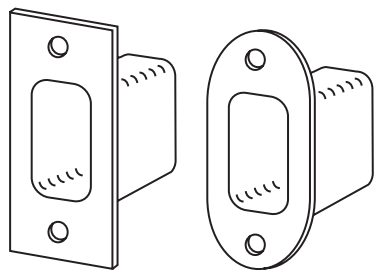
 <p>#347 ASA</p> <p>#350 T</p>	 <p>#345 (for wood doors)</p> <p>#346 (for metal doors)</p>	 <p>BX91D (D Series)</p> <p>BX91 (E Series)</p>
--	---	--

Parts:

Thick Door Pack – For doors 2-1/4" thick

E Series Deadbolts



CLASSIC PRODUCT

ASSA ABLOY

D, E, DBX Series Deadbolts:

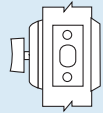
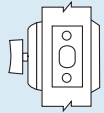
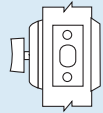
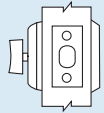
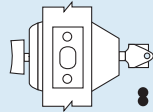
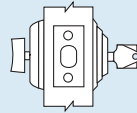
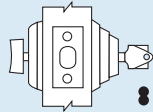
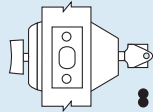
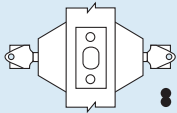
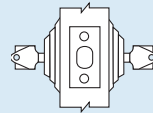
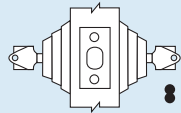
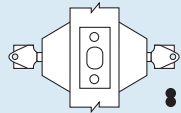
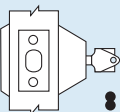
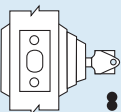
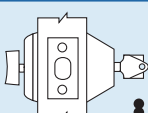
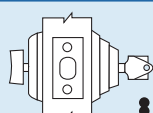
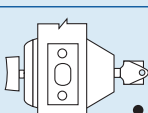
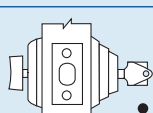
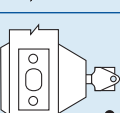
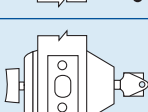
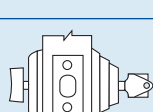
GRADE 1			GRADE 2			FUNCTION	OPERATION	
ARROW CODE	BHMA		ARROW CODE	BHMA			INSIDE	OUTSIDE
D60	E0111		E60	E0112		Exit	Turnpiece Retracts & Projects Bolt	Blank Plate
D61	E0151		E41	E0152		Single Cylinder	Turnpiece Retracts & Projects Bolt	Key Retracts & Projects Bolt
			E61					
			DBX61					
D62	E0141		E42	E0142		Double Cylinder	Key Retracts & Projects Bolt	Key Retracts & Projects Bolt
			E62					
			DBX62					
D63	E0161		E63	E0162		Single Cylinder	Blank Plate	Key Retracts & Projects Bolt
D64	E0171		E64	E0172		Classroom	Turnpiece Retracts Bolt But Does Not Project Bolt	Key Retracts & Projects Bolt
D71-IC	E0151		E71-IC	E0152		Single Cylinder With Concealed Mounting Screws (IC Only)	Turnpiece Retracts & Projects Bolt	Key Retracts & Projects Bolt
D73-IC	E0161		—	—	—	Single Cylinder With Concealed Mounting Screws (IC Only)	Blank Plate	Key Retracts & Projects Bolt
D74-IC	E0171		E74-IC	E0172		Classroom With Concealed Mounting Screws (IC Only)	Turnpiece Retracts Bolt But Does Not Project Bolt	Key Retracts & Projects Bolt

E Series Deadbolts



CLASSIC PRODUCT

ASSA ABLOY

How To Order:

How to Order E Series Deadbolt:

Example: To order a E Series Single Cylinder Deadbolt, Satin Chromium Plated finish, 1-1/8" x 2-3/4" square two-hole metal corner strike, a 2-3/4" backset with 1-1/8" square corner latch, AR cylinder keyway, keyed different.

Specify:

Series	Function	Finish	Strike	Bolt	Cylinder Keyway	Keying Cylinder
E	61	26D	346	144	AR	KD

The ASSA ABLOY Group is the global leader in access solutions. Every day, we help billions of people experience a more open world.

ASSA ABLOY Opening Solutions leads the development within door openings and products for access solutions in homes, businesses and institutions. Our offering includes doors, frames, door and window hardware, mechanical and smart locks, access control and service.



ASSA ABLOY

Arrow Lock & Door Hardware
225 Episcopal Road
Berlin, CT 06037
Customer Service: 1-800-327-8539
Technical Product Support: 1-800-327-8539 X2
www.arrowlock.com



ASSA ABLOY

Experience a safer
and more open world

DBX Series Deadbolt



General Specs:

- **Door Thickness** – Standard cylinder unit – 1-3/8" to 1-3/4" (35mm to 44mm). SFIC unit – 1-3/8" to 2" (35mm to 51mm). Thick door kits available up to 2" (51mm).
- **Backset** – Adjustable 2-3/8" (60mm) to 2-3/4" (70mm).
- **Latch Bolt** – 1" (25mm) throw steel deadbolt with hardened, free spinning, steel pin insert.
- **Bolt Front** – 2-1/4" (57mm) x 1" (25mm). Plastic spacer supplied for 1-1/8" (29mm) mortise.
- **Steel Strike** – 1-1/16" (27mm) x 2-3/4" (70mm) x 0.05" (0.13" (3mm) thick with wood frame reinforcer).
- **Cylinder and Keys** – Solid brass 6 pin cylinder. Two brass keys furnished standard. Arrow "A" or Schlage "C" keyway available. Optional SFIC lock prep available (less core).
- **Packaging** – 12 per case.
- **Warranty** – 1 year.

The DBX Series deadbolt is a professional replacement Grade 2 commercial deadbolt. The flexible design offers an adjustable backset in an attractive low profile package. The DBX is ideal for commercial common areas and residential applications.

Finishes:

BHMA	U.S. Equivalent	Arrow Code	Finish Description	
605	US3	03	Bright Brass	
613E	US10BE	613E	Dark Oxidized Satin Bronze Equivalent	
630	US32D	630	Satin stainless steel	
693		693	Black powder coat paint	

Certification & Compliance:



- Certified ANSI/BHMA A156.36 Auxiliary Locks, Grade 2.
- UL/cUL – All locks listed for 3-hour A label single door, 4' x 8'.

WARNING

This product can expose you to lead which is known to the state of California to cause cancer and birth defects or other reproductive harm. For more information go to www.P65warnings.ca.gov.

DBX Series Deadbolts

PROFESSIONAL REPLACEMENT PRODUCTS

DBX Deadbolt:

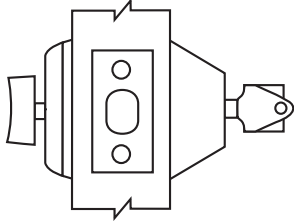

DBX61

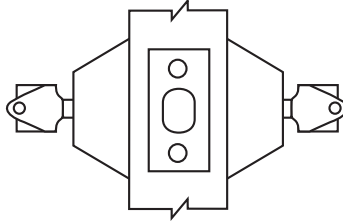

DBX62

Strike: DBX-394

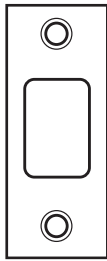

Strike
1-1/16" x 2-3/4"

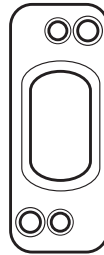

Strike Reinforcer
1-1/16" x 2-3/4"

Latch:

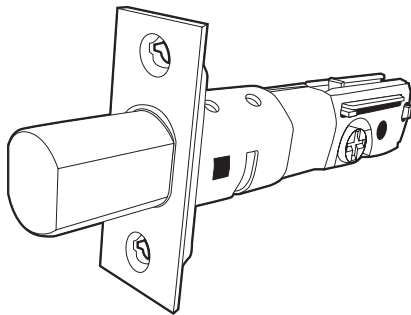

Adjustable Backset	Front	Part Number
2-3/8" - 2-3/4"	1" x 2-1/4"	DBX-L14

Adjustable Drive-in deadbolt available separately. Part Number DBX-L18

How to Order:

Series	Function	Finish	Keyway	Keying
DBX	61	630	AR	KA4

The ASSA ABLOY Group is the global leader in access solutions. Every day, we help billions of people experience a more open world.

ASSA ABLOY Opening Solutions leads the development within door openings and products for access solutions in homes, businesses and institutions. Our offering includes doors, frames, door and window hardware, mechanical and smart locks, access control and service.



ASSA ABLOY

Arrow Lock & Door Hardware
225 Episcopal Road
Berlin, CT 06037
Customer Service: 1-800-327-8539
Technical Product Support: 1-800-327-8539 X2
www.arrowlock.com



ASSA ABLOY

Experience a safer
and more open world

BMX Series Mortise Locks



Features:

Handing – Handed; field reversible. The lockset can be re-handed without disassembling the lock case.

Door Thickness – 1-3/4" (4mm) standard.

Backset – 2-3/4" (70mm).

Lockcase – Heavy gauge steel, with zinc dichromate finish for corrosion resistance. 5-7/8" (149mm) x 4" (102mm) x 15/16" (24mm).

Armored Front – Heavy gauge steel, 8" (203 mm) x 1-1/4" (32mm) x 3/32" (2mm). Accommodates flat doors and doors beveled 1/8" (3mm) in 2" (51mm).

Faceplate – Wrought brass or stainless steel. Attached by machine screws to lockcase front.

Latchbolt – Stainless steel, 2 piece mechanical with anti-friction insert. 5/8" (16mm) x 1" (25mm) x 3/4" (19mm) throw.

Auxiliary Latchbolt – 9/16" (14mm) effective throw and 3/8" (10mm) effective auxiliary latch deadlocking.

Deadbolt – One-piece stainless steel, 19/32" (15mm) x 1 1/4" (32mm) x 1" (25mm) throw.

Hub – nickel steel, 5/16" (8mm).

Spacing – Center to center, hub to cylinder: 3-5/8" (92mm).

Strike – Wrought brass or stainless steel. ANSI straight lip standard, 4-7/8" (124mm) x 1-1/4" (32mm) 1-1/8" (29mm) lip to center. Optional ANSI wrought strike box available.

Keying Features Available – Conventional mortise cylinders, 6-pin solid brass with two nickel silver keys in the Arrow AR keyway keyed different supplied standard.

Use the Less Cylinder option if conventional mortise cylinders in other keyways or key grouping are required (ordered separately).

Optional prep for small format interchangeable core cylinders is available in 6-pin (IC6) or 7-pin (IC7) mortise housings (SFIC cylinders not included).

Warranty – Five-year limited.

Standardized Case – One size case for uniform mortising.

Thru-Bolted Trim Design – Thru-bolted trim designs for the proper alignment and increased security.

Designs – Including knob and lever handles for roses and escutcheons in the most popular finishes.

Range of Functions – To meet common requirements.

Arrow mortise locks are intended for heavy duty use in schools, hospitals and commercial buildings where security, durability and low maintenance are required. They are engineered for strength and performance, and precisely manufactured to exacting standards.



Applications:

The BMX Series offers a selection of preferred trim designs and functions which meet or exceed the performance requirements of ANSI/BHMA Grade 1.

Arrow mortise locks can be found in the following types of facilities:

- Schools
- Office Buildings
- Multi-Family Housing
- Hospitals
- Government

Certification & Compliance:



ANSI/BHMA

- Certified A156.13 Series 1000, Operational Grade 1.

UL/ULC Positive Pressure

- All locks listed for A Label and lesser class doors, 4" (122cm) x 10" (305cm) single or 8" (244cm) x 10" (305cm) pair. Letter F and UL symbol on armored front indicate listing.

California State Reference Code

- All levers with returns comply; levers return to within 1/2" (13mm) of door face.

ADA requirements (Americans with disabilities Act)

- Acceptable Door Hardware: Section 4.13.9
- Handles, pulls, latches and other operating devices on accessible doors shall have a shape that is easy to grasp with one hand and does not require grasping, tight pinching or twisting of the wrist to operate. Lever operated mechanisms, push-type mechanisms and "U" shaped handles are acceptable designs.

Finishes:

ANSI/BHMA	US Equivalent	Arrow Code	Finish Description	
605	US3	03	Bright Brass	
606	US4	04	Satin Brass	
613E	613E	US10BE	Dark Oxidized Satin Bronze Equivalent	
626	US26D	26D	Satin Chromium Plated	
BSP	BSP	—	Black Suede Powder Coat	

Look for the universal symbol next to Arrow products that comply with ADA accessibility requirements.

Function:

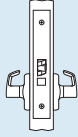
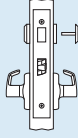
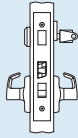
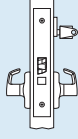
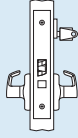
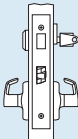
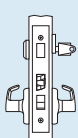
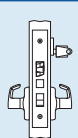
ARROW	FUNCTION	ANSI	INSIDE/OUTSIDE	DESCRIPTION
01	Passage	F01		Latchbolt by lever either side
02	Privacy	F19		Latchbolt by lever either side, except when outside is locked by turnpiece inside. Outside emergency release or operating from inside unlocks lock. Inside lever retracts both bolts.
11	Apartment/ Front Door	F08/F11		Latchbolt by lever either side except when outside lever is locked by stopworks in lock front, or when the deadbolt is projected. Deadbolt operates by key outside and turnpiece inside. Turning inside lever will retract latchbolt and deadbolt simultaneously.
12	Storeroom	F07		Outside lever always rigid. Latchbolt retracted only by key outside or by inside lever. Auxiliary latchbolt deadlocks latchbolt.
17	Classroom	F05		Latchbolt operated by lever either side, except when outside lever is locked by key outside. Key operates latch or unlocks outside lever. Inside lever is always free. Auxiliary latchbolt deadlocks latchbolt.
19	Dormitory/Exit	F13		Latchbolt operated by lever either side. When outside lever is locked by projected deadbolt, (by inside turnpiece or outside key) key outside will retract deadbolt, then latchbolt. Turning inside lever will retract latchbolt and deadbolt simultaneously, which will unlock outside lever. When deadbolt is projected, the latchbolt is deadlocked.
20	Entrance/Dormitory	F20		Latchbolt operated by lever either side, except when outside lever is locked by stopworks in lock front, or by projecting deadbolt by turnpiece inside or key outside. Turning inside lever will retract latchbolt and deadbolt simultaneously. Deadbolt operated by turnpiece inside or key outside. When deadbolt is projected the latchbolt is deadlocked. Auxiliary latchbolt deadlocks latchbolt.
22	Office	F04		Latchbolt operated by lever either side except when outside lever is locked by stopworks in lock front then operated by key outside. Auxiliary latchbolt deadlocks latchbolt.

Broadway:

BRL

Lever: BR - Cast Brass or Stainless Steel

Rose: L - Wrought Brass or Stainless Steel

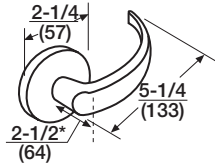

BRG

Lever: BR - Cast Brass or Stainless Steel

Escutcheon: G - Wrought Brass or Stainless Steel

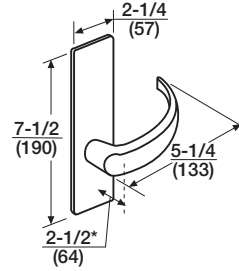

Hastings:

HSL

Lever: HS - Wrought Brass or Stainless Steel

Rose: L - Wrought Brass or Stainless Steel

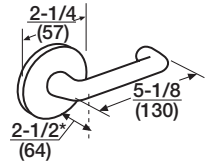

HSG

Lever: HS - Wrought Brass or Stainless Steel

Escutcheon: G - Wrought Brass or Stainless Steel

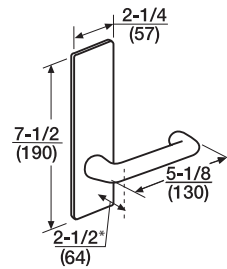

6 or 7 pin SFIC housings are available.

Ventura:

VL

Lever: V - Cast Brass or Stainless Steel

Rose: L - Wrought Brass or Stainless Steel

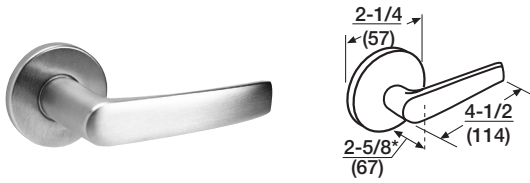

VG

Lever: V - Cast Brass or Stainless Steel

Escutcheon: G - Wrought Brass or Stainless Steel

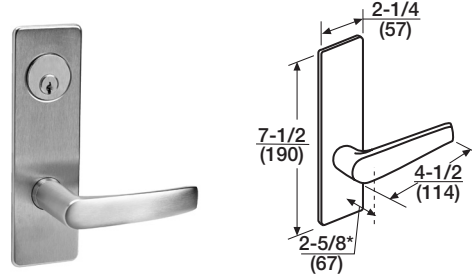

Xavier:

XL

Lever: X - Cast Brass or Stainless Steel

Rose: L - Wrought Brass or Stainless Steel

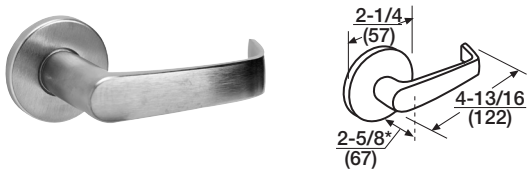

XG

Lever: X - Cast Brass or Stainless Steel

Escutcheon: G - Wrought Brass or Stainless Steel

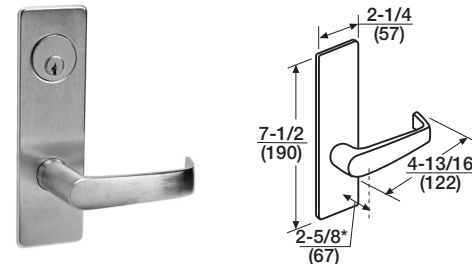

Ball:

BL

Knob: B - Cast Zinc

Rose: L - Wrought Brass or Stainless Steel

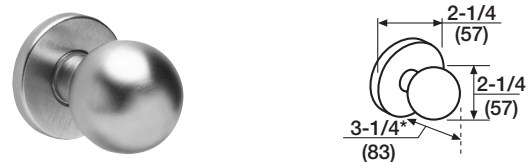

BG

Knob: B - Cast Zinc

Escutcheon: G - Wrought Brass or Stainless Steel

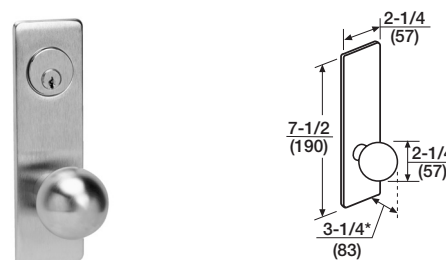

6 or 7 pin SFIC housings are available.

Strikes:

ANSI Straight Lip (standard)

- Brass or Stainless Steel (base material)
- Non-handed
- 4-7/8" (124mm) x 1-1/4" (32mm) x 1-1/8" (29mm) lip to center

ANSI Curved Lip

- Brass or Stainless Steel (base material)
- Handed
- 4-7/8" (124mm) x 1-1/4" (32mm) x 1-1/4" (32mm) lip to center

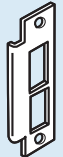
		PART NO.	DESCRIPTION
All Latchbolt and Latchbolt x Deadbolt Functions		BMX-460	Straight Lip
		BMX-468	Curved Lip for RH, LHR
		BMX-466	Curved Lip for LH, RHR
	Straight Lip	Curved Lip	

Cylinder:

Cylinder

- MC61 - 1-1/8" for 1-3/4" door. Collar-16-113A
- Finishes - 03, 04, 613E, 32D.

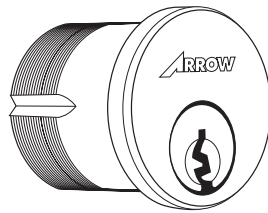

Housings for Small Format Interchangeable Core (SFIC)

- 16CR-16 - 6 pin-1/8"
- 16CR-27 - 6 or 7 pin 1-1/4"
- Collar - 16-113A
- Finishes - 03, 04, 613E, 26D.

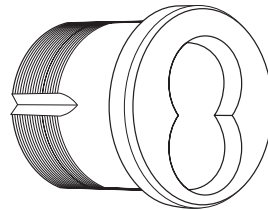

Cylinder Collars:

Mortise Cylinder Collar 16-113A

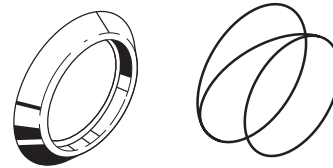

Thumb Turn BMX-17A:

- Furnished with rose trim. For escutcheon trim, thumb turn is mounted on escutcheon.
- Finishes - 605, 606, 613E, 626, BSP.

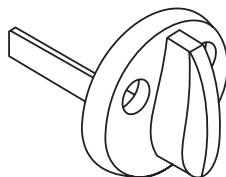

Cams:

001



Used with functions 12, 17, 22

AM2

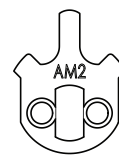

Used with deadbolt functions 11, 19, 20

Face Plates (Scalps):

Part No.
AM11-305



Function
11

Part No.
AM12-305



Function
12, 17

Part No.
AM02-305



Function
02, 19

Part No.
AM22-305



Function
22

Part No.
AM01-305



Function
01

Part No.
AM20-305



Function
20

Spindle:

BMX-385A

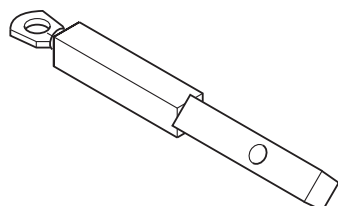

How to Reverse Handing:

BMX Series Mortise Locks are easily field reversible for installation on doors of any hand. Re-handing can be done quickly and easily without opening the lock case.

1. Move the Red locking screw to side of lock-body being locked (Figure 1)

2. Push in latch partially then depress catch plate with screwdriver (Figure 1)

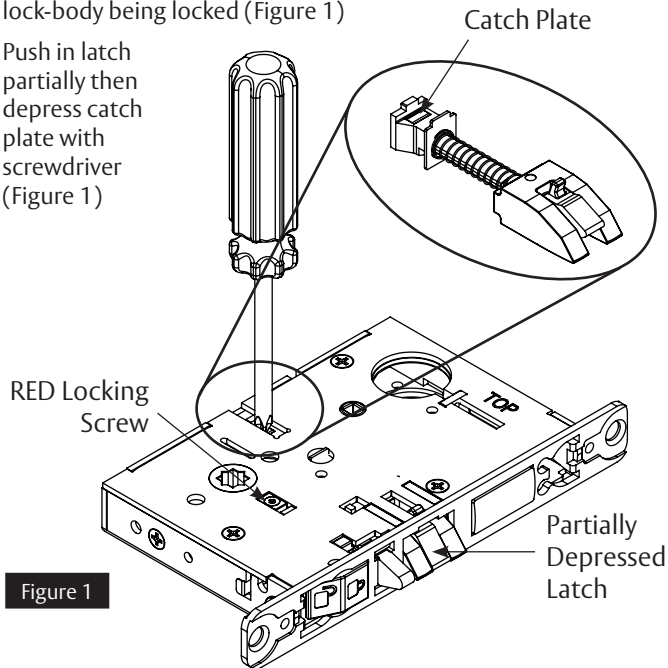

Figure 1

3. Pull latch out of lock-body and rotate 180 degrees (Figure 2)

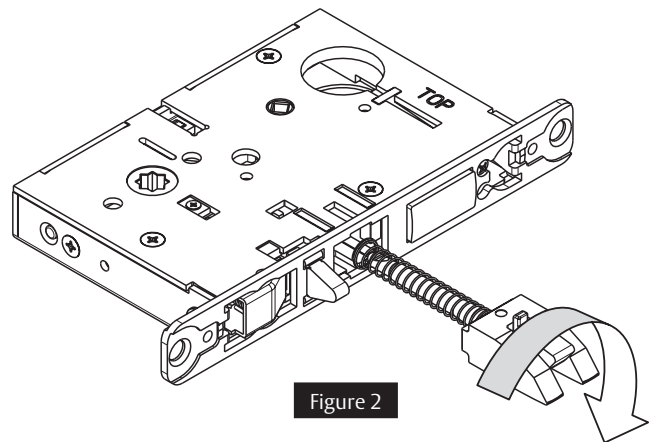

Figure 2

4. Push in latch until tail-piece hits back of case (Figure 3)

Note: Make sure catch plate is even with top surface and locking pin is not projected (Figure 4). If not, depress catch plate with screwdriver and repeat step 4.

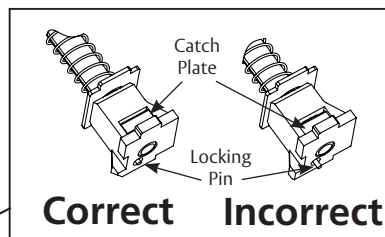

Figure 4

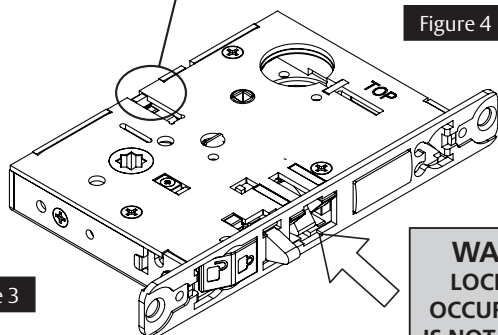

Figure 3

WARNING:
LOCK-IN CAN
OCCUR IF LATCH
IS NOT PROPERLY
INSTALLED

5. Rotate lock front to match bevel of door as shown (Figure 5)

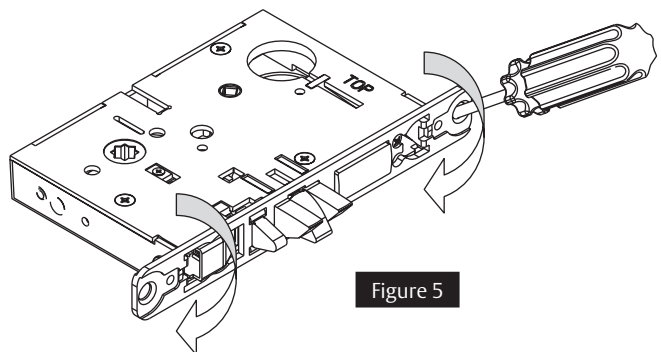

Figure 5

Suggested Specification:

All locksets shall be Mortise Locksets as supplied by Arrow Lock company.

Locks shall have all functions available in one size case, manufactured from heavy gauge steel, minimum thickness 3/32". The handing of all locks shall be reversible without the disassembly of the lockcase. Cases are to be closed on all sides to protect internal parts. Locks are to have adjustable, beveled and armored fronts, standard 2-3/4" backset, a full 3/4" throw two-piece mechanical anti-friction latchbolt, and a one-piece stainless steel 1" throw deadbolt, and shall be available for a minimum door thickness of 1-3/8". Internal parts shall be heavy gauge steel, zinc dichromate plated for corrosion resistance.

All locksets with latchbolts, regardless of trim, shall be listed by Underwriters Laboratories for A label and lesser class doors, 4' x 10' single or 8' x 10' pair. Cylinder options shall include interchangeable core.

Lock trim (knob, lever, sectional or escutcheon) shall be throughbolted through the lockcase to assure correct alignment and proper operation.

Certification:

UBC-7(1997) and UL10C-Positive Pressure
ANSI/BHMA A156.13 Series 1000, Operational Grade 1
ANSI A117.1, Accessibility Code, 1989 (Formerly Tile 19, California State Fire Marshal Standard) (lever handle trim).

All locks, trim, and cylinders shall be from one manufacturer.

All locksets shall carry a five-year limited warranty.



Order Example:

Example:

To order a BMX Series Apartment function mortise lock with the BR lever and G escutcheon design, satin chrome finish, with a straight lip strike, right handed, mortise cylinder with the Arrow AR keyway keyed different.

Specify:

Standard:

Series	Function	Design	Finish	Strike	Handing	Keying	Options (if required)
BMX	11	BR G	626	460	RH	AR KD	

BMX Series Mortise Locks



ASSA ABLOY

Notes:

The ASSA ABLOY Group is the global leader in access solutions. Every day, we help billions of people experience a more open world.

ASSA ABLOY Opening Solutions leads the development within door openings and products for access solutions in homes, businesses and institutions. Our offering includes doors, frames, door and window hardware, mechanical and smart locks, access control and service.



ASSA ABLOY

Arrow Lock & Door Hardware
225 Episcopal Road
Berlin, CT 06037
Customer Service: 1-800-327-8539
Technical Product Support: 1-800-327-8539 X2
www.arrowlock.com



ASSA ABLOY

Experience a safer
and more open world



N Series Deadlock



General Specifications:

Housing – Heavy wrought steel with zinc dichromate finish.

Deadbolt – 1" (25.40mm), laminated stacked steel with hardened pin.

Backset – 2-3/4" (69.85mm).

Doors – 1-3/8" (34.92mm) to 1-3/4" (44.45mm) thick standard.

Strikes – Supplied standard with #380 security strike for steel frame and #356 security strike for wood frame.

Handing – All functions are reversible.

Cylinder Options - N Series locksets are supplied with standard 1-1/8" solid brass 6-pin mortise cylinders with two nickel silver keys. The Arrow AR keyway is standard with optional Arrow sectional keyways and the Schlage C keyway. Keyed different is the standard with keyed alike, O-bit, and master keying available. Optional prep for small format interchangeable core cylinder is available in 6-pin or 7-pin mortise housing (SFIC cylinder not included).

Arrow N Series Mortise deadlock security and mortise cylinder convenience with interchangeable core compatibility.



Certification and Compliance:

Underwriters Laboratories (UL and CUL) listed for use on A label or lesser doors when used in conjunction with a rated primary latching device

Function:

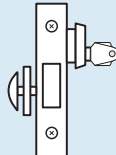
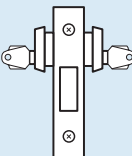
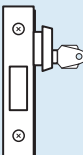
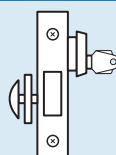
ARROW	ANSI/BHMA	FUNCTION	N SERIES	DESCRIPTION
N40	F01	Exit		Throw or retract bolt by thumbturn only.
N41	E06071	Single Cylinder		Throw or retract bolt by key outside, thumbturn inside.
N42	E06061	Double Cylinder		Throw or retract bolt by key either side.
N43	E06081	Single Cylinder		Throw or retract bolt by key one side.
N44	E06091	Classroom		Throw or retract bolt by key—Thumbturn retracts dead bolt, but does not project it.

Order Example:

Example:

To order a N Series Single Cylinder Deadlock, Satin Chromium Plated finish with a 1-1/8" x 3-1/2" square corner strike, a 1" deadbolt, keyed different.

Specify:	Series	Function	Finish	Strike	Keying Cylinder
Standard:	N	41	26D	380	KD

Strikes:

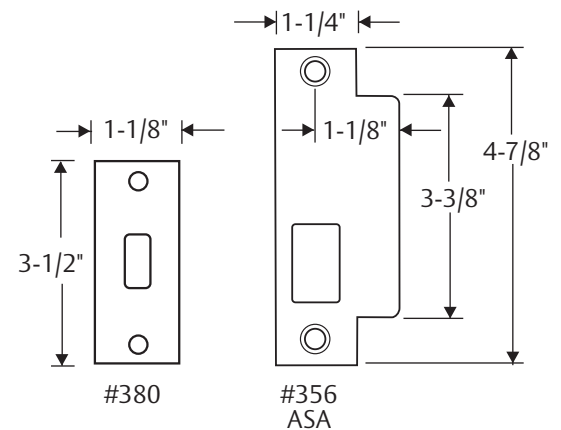

The ASSA ABLOY Group is the global leader in access solutions. Every day, we help billions of people experience a more open world.

ASSA ABLOY Opening Solutions leads the development within door openings and products for access solutions in homes, businesses and institutions. Our offering includes doors, frames, door and window hardware, mechanical and smart locks, access control and service.



ASSA ABLOY

Arrow Lock & Door Hardware
225 Episcopal Road
Berlin, CT 06037
Customer Service: 1-800-327-8539
Technical Product Support: 1-800-327-8539 X2
www.arrowlock.com



ASSA ABLOY

Experience a safer
and more open world

BM Series Mortise Locks



DISCONTINUED



Features:

Handing – Handed; field reversible. The lockset can be re-handed without disassembling the lock case.

Door Thickness – 1-3/4" (4mm) standard.

Backset – 2-3/4" (70mm).

Lockcase – Heavy gauge steel, with zinc dichromate finish for corrosion resistance. 5-7/8" (149mm) x 4" (102mm) x 15/16" (24mm).

Armored Front – Heavy gauge steel, 8" (203 mm) x 1-1/4" (32mm) x 3/32" (2mm). Accommodates flat doors and doors beveled 1/8" (3mm) in 2" (51mm).

Faceplate – Wrought brass, bronze or stainless steel. Attached by machine screws to lockcase front.

Latchbolt – Stainless steel, 2 piece mechanical with anti-friction insert. 5/8" (16mm) x 1" (25mm) x 3/4" (19mm) throw.

Auxiliary Latchbolt – 9/16" (14mm) effective throw and 3/8" (10mm) effective auxiliary latch deadlocking.

Deadbolt – One-piece stainless steel, 19/32" (15mm) x 1 1/4" (32mm) x 1" (25mm) throw.

Hub – nickel steel, 5/16" (8mm).

Spacing – Center to center, hub to cylinder: 3-5/8" (92mm).

Strike – Wrought brass, bronze or stainless steel. ANSI straight lip standard, 4-7/8" (124mm) x 1-1/4" (32mm) 1-1/8" (29mm) lip to center. Optional ANSI wrought strike box available.

Keying Features Available – Conventional mortise cylinders - AM and BM mortise locksets are supplied standard with solid brass 6-pin cylinders with two nickel silver keys. The Arrow AR keyway is standard with optional keyways Arrow sectional keyways and Schlage C keyway. Keyed different is the standard with keyed alike, O-bit, and master keying available. Optional prep for small format interchangeable core cylinders is available in 6-pin or 7-pin mortise housings (SFIC cylinder not included).

Warranty – Five-year limited.

Standardized Case – One size case for uniform mortising.

Reversibility – Locks are easily reversed for change of hand.

Self Aligning Trim – Standard with rose trim. Eliminates bind, facilitates installation, gives support and saves labor.

Designs – Broad spectrum of designs including lever handles for roses and escutcheons in architectural finishes.

Complete Range of Functions – To meet all requirements.

Arrow mortise locks are intended for heavy duty use in schools, hospitals and commercial buildings where security, durability and low maintenance are required. They are engineered for strength and performance, and precisely manufactured to exacting standards.



Applications:

Arrow mortise locks are offered in a complete range of functions designed for commercial, institutional and industrial applications. They are engineered for strength and performance, and precisely manufactured to exacting standards.

A wide selection of trim designs and functions are offered which meet or exceed the performance requirements of ANSI/BHMA Grade 1.

Arrow mortise locks can be found in the following types of facilities:

- Schools
- Office Buildings
- Multi-Family Housing
- Hospitals
- Government

Advantages:

- Easily reversible, enabling the user to reverse hands without disassembling lock case.
- Meets or exceeds ANSI/BHMA operational Grade 1 requirements.
- Throughbolted trim designs for proper alignment and increased security.
- Many trim designs to complement Arrow cylindrical locks and exit device trims.
- Keyed into new or existing Arrow or competitive master key systems.

* Note: Not all trim designs available in all finishes.

Certification & Compliance:



ANSI/BHMA

- Certified A156.13 Series 1000, Operational Grade 1.

UL/ULC Positive Pressure

- All locks listed for A Label and lesser class doors, 4" (122cm) x 10" (305cm) single or 8" (244cm) x 10" (305cm) pair. Letter F and UL symbol on armored front indicate listing.

California State Reference Code

- All levers with returns comply; levers return to within 1/2" (13mm) of door face.
- Meets ADA requirements (Americans with disabilities Act).
- Acceptable Door Hardware: Section 4.13.9
- Handles, pulls, latches and other operating devices on accessible doors shall have a shape that is easy to grasp with one hand and does not require grasping, tight pinching or twisting of the wrist to operate. Lever operated mechanisms, push-type mechanisms and "U" shaped handles are acceptable designs.

Look for the universal symbol next to Arrow products that comply with ADA accessibility requirements.



Finishes:

BHMA	US Equivalent	Arrow Code	Finish Description	
605	US3	03	Bright Brass	
606	US4	04	Satin Brass	
612	US10	10	Satin Bronze	
613	US10B	10B	Dark Oxidized Satin Bronze, Oil Rubbed	
625	US26	26	Bright Chromium Plated	
626	US26D	26D	Satin Chromium Plated	
629	US32	32	Bright Stainless Steel	
630	US32D	32D	Satin Stainless Steel	

Premier Product

ARROW	FUNCTION	ANSI	BM SERIES	DESCRIPTION
01	Passage	F01		Latchbolt by lever either side
02	Privacy	F19		Latchbolt by lever either side, except when outside is locked by turnpiece inside. Outside emergency release or operating from inside unlocks lock. Inside lever retracts both bolts.
08	Single Dummy Trim	--		Rigid lever one side of door only. Plug through edge of door ensures stability.
09	Double Dummy Trim	--		Rigid lever both sides of door. Plug through edge of door ensures stability.
11	Apartment/ Front Door	F12		Latchbolt by lever either side except when outside lever is locked by stopworks in lock front, or when the deadbolt is projected. Deadbolt operates by key outside and turnpiece inside. Turning inside lever will retract latchbolt and deadbolt simultaneously.
12	Storeroom	F07		Outside lever always rigid. Latchbolt retracted only by key outside or by inside lever. Auxiliary latchbolt deadlocks latchbolt.
13	Apartment/ Front Door	F21		Latchbolt operated by lever either side. Deadbolt operated by key outside and turnpiece inside. When deadbolt is projected, key outside will retract deadbolt, then latchbolt.
17	Classroom	F05		Latchbolt operated by lever either side, except when outside lever is locked by key outside. Key operates latch or unlocks outside lever. Inside lever is always free. Auxiliary latchbolt deadlocks latchbolt.
19	Dormitory/Exit	F13		Latchbolt operated by lever either side. When outside lever is locked by projected deadbolt, (by inside turnpiece or outside key) key outside will retract deadbolt, then latchbolt. Turning inside lever will retract latchbolt and deadbolt simultaneously, which will unlock outside lever. When deadbolt is projected, the latchbolt is deadlocked.

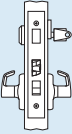
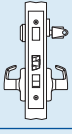
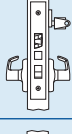
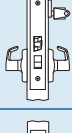
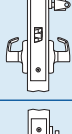
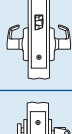
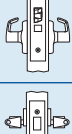
Premier Product

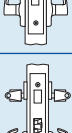
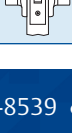
ARROW	FUNCTION	ANSI	BM SERIES	DESCRIPTION
20	Entrance/Dormitory	F20		Latchbolt operated by lever either side, except when outside lever is locked by stopworks in lock front, or by projecting deadbolt by turnpiece inside or key outside. Turning inside lever will retract latchbolt and deadbolt simultaneously. Deadbolt operated by turnpiece inside or key outside. When deadbolt is projected the latchbolt is deadlocked. Auxiliary latchbolt deadlocks latchbolt.
21	Front Door	F08, F10		Latchbolt operated by lever either side except when outside lever is locked by stopworks in lock front. Deadbolt is operated by turnpiece inside. Key outside operates both bolts.
22	Office	F04		Latchbolt operated by lever either side except when outside lever is locked by stopworks in lock front then operated by key outside. Auxiliary latchbolt deadlocks latchbolt.
23	Vestibule	--		Latchbolt operated by lever either side, except when outside lever is locked by stopworks in lock front, then operated by key outside.
24	Storeroom	--		Latchbolt operated by lever inside and by key outside. Outside lever always rigid. Inside lever always free.
26	Privacy	F22		Latchbolt by lever either side, except when outside is locked by turnpiece inside. Operating inside lever, closing door, or with outside emergency release unlocks outside.
27	Institutional	--		Latchbolt by lever either side, except when Privacy outside is locked by turnpiece inside. Operating inside lever or closing door unlocks outside. Key outside retracts latch at all times, even if thumbturn is held in locked position. Auxiliary latch deadlocks latchbolt.
31	Storeroom	F14		Latchbolt operated by lever either side. Deadbolt is operated by key from either side. When deadbolt is projected, key either side will retract deadbolt, then latchbolt.
32	Vestibule	F09		Latchbolt operated by lever either side, except when outside lever is locked by key from the inside cylinder. When outside lever is locked, latchbolt is retracted by key outside or by lever inside. Auxiliary latchbolt deadlocks latchbolt.
33	Storeroom	F30		Both levers rigid at all times. Auxiliary latchbolt deadlocks latchbolt. Latchbolt operated only by key from either side.
34	Storeroom	F35		Latchbolt operated by lever either side except when the outside lever is locked by stop works in lock front then operated by key outside or by lever inside. Deadbolt operated by key from either side.

Premier Product

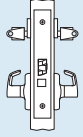
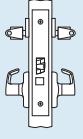
ARROW	FUNCTION	ANSI	BM SERIES	DESCRIPTION
37	Classroom	F32		Latchbolt by lever either side. Except when outside is locked from inside or outside by key. When outside is locked, latchbolt is retracted by key from inside or outside or by operating inside lever. Auxiliary latch deadlocks latchbolt.
38	Classroom	--		Latchbolt by lever from either side unless outside lever is locked by projection of deadbolt. Deadbolt thrown by key from either side. Inside lever simultaneously retracts latchbolt and deadbolt, outside lever remains locked. Retracting latchbolt by key unlocks outside lever. Auxiliary latch deadlocks latchbolt.

Electrical Lock Functions:

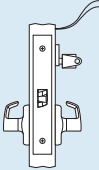
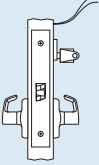
BM17 SUFFIX	VOLTAGE	CURRENT	BM SERIES	DESCRIPTION
177 179	12V AC/DC 24V AC/DC	612mA 330mA		FAIL SAFE: Power on locks outside lever. Inside lever always free. Latch retracted by key when locked electrically.
181 183	12V AC/DC 24V AC/DC	612mA 330 mA		FAIL SECURE: Power off locks outside lever. Inside lever always free. Latch retracted by key when locked electrically.

Reversing Hand:

Mortise Locksets BM Series

Please read completely before proceeding and review the drawing below.

Minimal force is required to reverse handing.

1. Remove the armored front.
2. Remove the lockset from the door.
3. Fully depress the latchbolt and hold in the depressed position.
4. With minimal force, depress the catch plate, located at the end of the latchtail, through the oblong cutout in the lockcase cap. While depressing the catch plate, release the latchbolt and remove latch from the lock.
5. Turn the latchbolt over and reinstall into the lock.
6. Depress the latchbolt until it re-engages the tail socket.
7. Remove the red headed screw from the stopworks and place it in the stopworks on the opposite side of the case.
8. Loosen the front screw to change the bevel. Tighten the front screws.
9. Reinstall the lock and armored front into the door.
10. If changing bevel only, i.e. RH to RHR. Omit step 7.

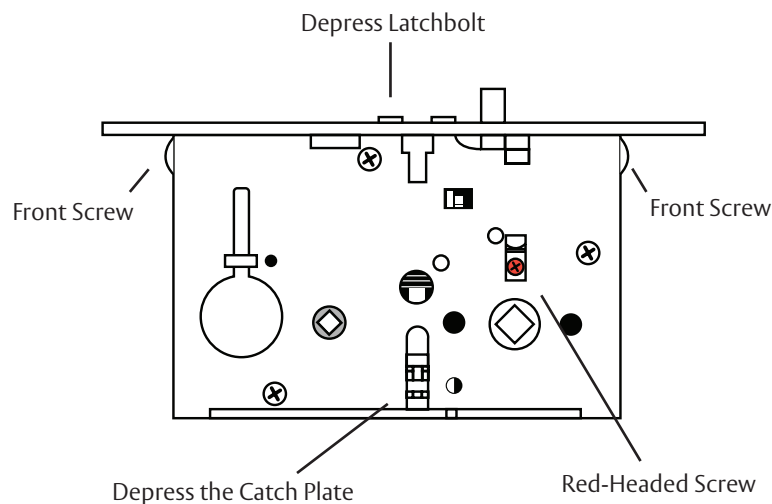

Premier Product

Broadway:

BRL

Lever: BR - Cast

Rose: L- Wrought Brass, Bronze or Stainless Steel

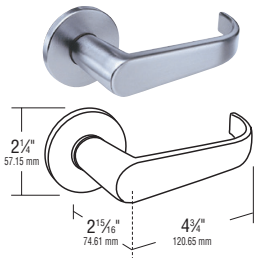

BRG

Lever: BR - Brass or Bronze

Escutcheon: G- Brass, Bronze or Stainless Steel

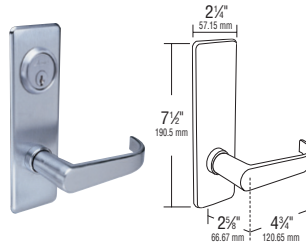

BRH

Lever: BRH - Cast

Escutcheon: H- Wrought Brass, Bronze or Stainless Steel

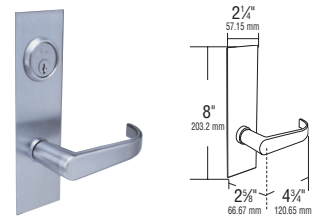

Hastings:

HSL

Lever: HS - Cast

Rose: L- Brass, Bronze or Stainless Steel

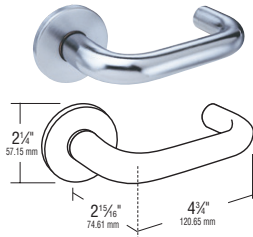

HSG

Lever: HS - Cast

Escutcheon: G- Wrought Brass, Bronze or Stainless Steel

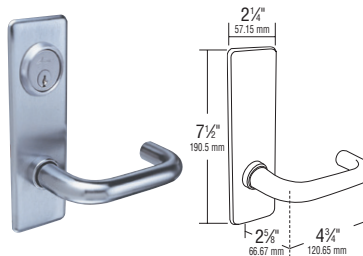

HSH

Lever: HS - Cast

Escutcheon: H- Wrought Brass, Bronze or Stainless Steel

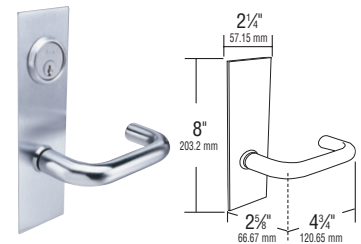

Javelin:

JL

Lever: J - Forged Brass or Cast Bronze

Rose: L- Wrought Brass or Bronze

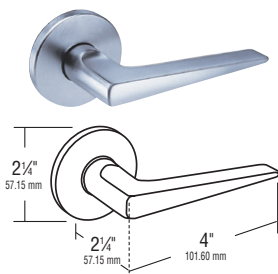

JG

Lever: J - Forged Brass or Cast Bronze

Escutcheon: G- Wrought Brass, Bronze or Stainless Steel

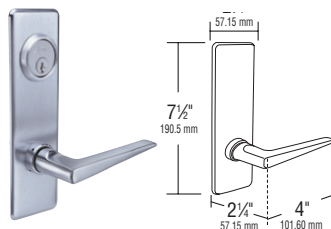

JH

Lever: J - Forged Brass or Cast Bronze

Escutcheon: H- Wrought Brass, Bronze or Stainless Steel

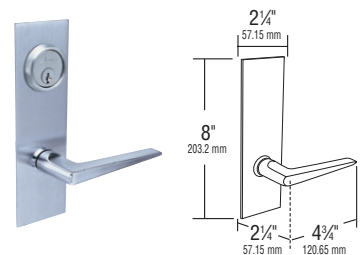

Premier Product

Neo:

NL

Lever: N - Brass, Bronze or Stainless Steel

Rose: L - Brass, Bronze or Stainless Steel

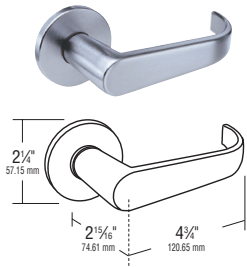

NG

Lever: N - Brass, Bronze or Stainless Steel

Escutcheon: G - Brass, Bronze or Stainless Steel

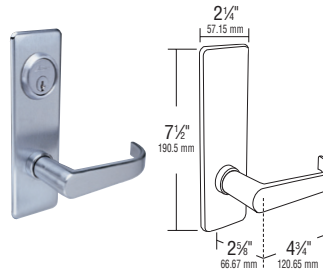

NH

Lever: N - Brass, Bronze or Stainless Steel

Escutcheon: H - Wrought Brass, Bronze or Stainless Steel

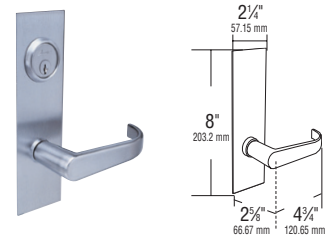

Ventura:

VL

Lever: V - Forged Brass, Cast Bronze or Stainless Steel

Rose: L - Brass, Bronze or Stainless Steel

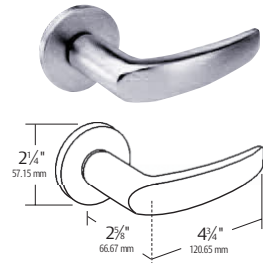

VG

Lever: V - Forged Brass, Cast Bronze or Stainless Steel

Escutcheon: G - Wrought Brass, Bronze or Stainless Steel

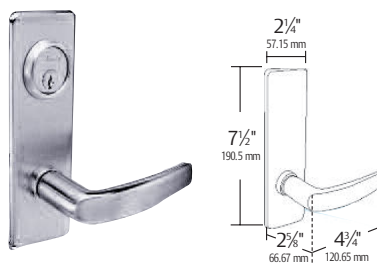

VH

Lever: V - Forged Brass, Cast Bronze or Stainless Steel

Escutcheon: H - Wrought Brass, Bronze or Stainless Steel

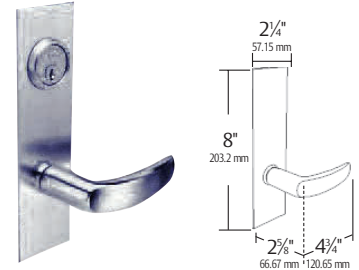

Xavier:

XL

Lever: X - Forged Brass, Cast Bronze or Stainless Steel

Rose: L - Wrought Brass, Bronze or Stainless Steel

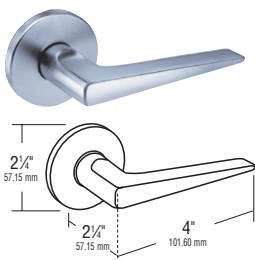

XG

Lever: X - Forged Brass, Cast Bronze or Stainless Steel

Escutcheon: G - Wrought Brass, Bronze or Stainless Steel

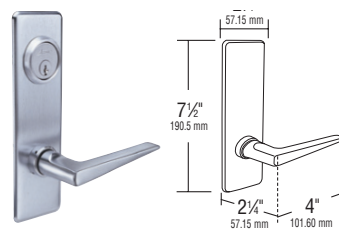

XH

Lever: X - Forged Brass, Cast Bronze or Stainless Steel

Escutcheon: H - Wrought Brass, Bronze or Stainless Steel

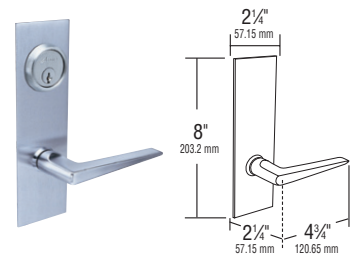

Premier Product



Strikes:

ANSI Straight Lip (standard)

- Brass or Stainless Steel
- Non-handed
- 4-7/8" (124mm) x 1-1/4" (32mm) x 1-1/8" (29mm) lip to center

ANSI Curved Lip

- Brass or Stainless Steel
- Handed
- 4-7/8" (124mm) x 1-1/4" (32mm) x 1-1/4" (32mm) lip to center

		PART NO.	DESCRIPTION
All Latchbolt and Latchbolt x Deadbolt Functions		460	Straight Lip
		468	Curved Lip for RH
		466	Curved Lip for LH

Cylinder:

Cylinder

- MC61 - 1-1/8" for 1-3/4" door. Collar - 16-113A
- Finishes - 3, 4, 10, 10B, 32, 32D.

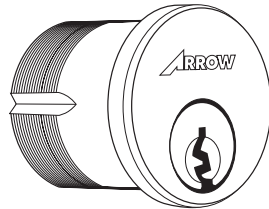

Cylinder for Interchangeable Core

- 16CR-16 - 6 pin-1-1/8"
- 16CR-27 - 6 or 7 pin 1-1/4"
- Collar - 16 - 113A
- Finishes - 3, 4, 10, 10B, 26, 26D

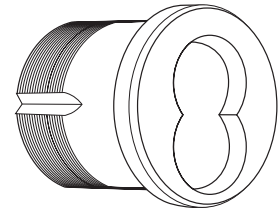

Cylinder Collars:

I.C. Mortise Cylinder Collar 16-113A

(Standard for 16CR-14, 16CR-26, 16CRH-26)

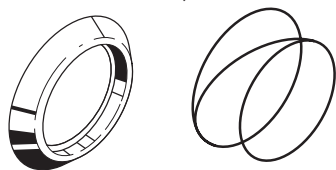

Spacer Rings:

16CR-123-1 1-1/8" Thick



16CR-123-1 1-1/4" Thick



16CR-123-1 (Standard for 16RCH-26) 3/8" Thick

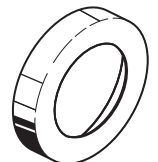

Thumb Turn 16-17A:

- Furnished with rose trim. For escutcheon trim, thumb turn is mounted on escutcheon.
- Finishes - 3, 4, 10, 10B, 26, 26D.

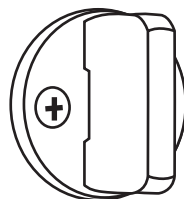

Cams:

001



Used with functions 12, 17, 22, 23, 24, 27, 32 (I/S), 33, 37.

AM2

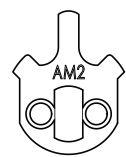

Used with deadbolt functions 11, 13, 19, 20, 21, 31, 32 (O/S), 43, 38, 40, 41, 42, 44.

Premier Product

Face Plates (Scalps):

Part No.
AM-15-305

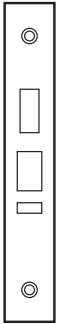

Function
38

Part No.
AM11-305



Function
11, 21, 34

Part No.
AM12-305



Function
07, 12, 17, 27,
32, 33, 37

Part No.
AM02-305



Function
02, 13, 19, 31

Part No.
AM22-305



Function
22

Part No.
AM23-305



Function
23

Part No.
AM41-305



Function
40, 41, 42, 44

Part No.
AM01-305

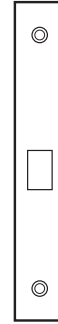

Function
01, 24, 26

Part No.
AM20-305



Function
20

Spindle:

Lever Spindle

BM 385A-For trim with "H" escutcheon and rose trim

BM 386A-For trim with "G" escutcheon



Suggested Specification BM:

All locksets shall be Mortise Locksets as supplied by Arrow Lock company.

Locks shall have all functions available in one size case, manufactured from heavy gauge steel, minimum thickness 3/32", chrome plated for corrosion resistance and lubricity of parts. The handing of all locks shall be reversible without the disassembly of the lockcase. Cases are to be closed on all sides to protect internal parts. Locks are to have adjustable, beveled and armored fronts, standard 2-3/4" backset, a full 3/4" throw two-piece mechanical anti-friction latchbolt, and a one-piece stainless steel 1" throw deadbolt, and shall be available for a minimum door thickness of 1-3/8". Internal parts shall be heavy gauge steel, zinc dichromate plated for corrosion resistance.

All locksets with latchbolts, regardless of trim, shall be listed by Underwriters Laboratories for A label and lesser class doors, 4' x 10' single or 8' x 10' pair. Cylinder options shall include interchangeable core.

Lock trim (knob, lever, sectional or escutcheon) shall be throughbolted through the lockcase to assure correct alignment and proper operation.

Certification:

ULC-7(1997) and UL10C-Positive Pressure
ANSI A156.13 Series 1000, Operational Grade 1
ANSI A117.1, Accessibility Code, 1989 (Formerly Tile 19, California State Fire Marshal Standard) (lever handle trim).

All locks, trim, and cylinders shall be from one manufacturer.

All locksets shall carry a five-year limited warranty.



Order Example:

Example:

To order a AM Series Apartment function Mortise lock with TA design, satin chrome finish, with a straight lip strike, right handed, keyed different.

Specify:

Standard:

Series	Function	Design	Finish	Strike	Handing	Keying	Options (if required)
RL	11	TA	26D	460	RH	KD	XXX

Competitor Indicator Kits

Indicators can be used in a variety of applications and are most commonly used to identify occupancy or display the locked/unlocked status of a room. Upgrade existing Best® or Schlage® mortise locks with a retrofit indicator kit from Arrow. These kits offer a seamless upgrade to existing sectional mortise locks to add security and privacy from Arrow.



Finishes:

BHMA	US Equivalent	Arrow Code	Finish Description	
605	US3	03	Bright Brass	
606	US4	04	Satin Brass	
612	US10	10	Satin Bronze	
613	US10B	10B	Dark Oxidized Satin Bronze, Oil Rubbed	
625	US26	26	Bright Chromium Plated	
626	US26D	26D	Satin Chromium Plated	
629	US32	32	Bright Stainless Steel	
630	US32D	32D	Satin Stainless Steel	

Features:

- Can be mounted on the inside, outside or both sides of the door
- Available for a variety of Best® and Schlage® functions
- Viewing window 25% larger than competition
- Patented curved design for viewing at multiple angles
- Window located prominently above the cylinder
- Highly reflective viewing window for increased safety
- Multiple color, text, graphic and language combinations available
- Covers existing Best® or Schlage® sectional trim indicator preps
- Two-year warranty

Typical Applications:

- Classroom doors
- Privacy rooms
- Nursing/new mother rooms
- Patient rooms
- Restrooms
- Meeting rooms

Certifications:

- UL/cUL Classified for use on 3 hr doors using Schlage® L9000 or Best® 45H/34H/35H mortise locks

Premier Product

Best® Mortise Locks

Sectional trim indicator kits are available to retrofit to Best® 45H, 34H or 35H series mortise locks. Kits can be ordered to be used on the inside, outside or both sides of the door. Each kit includes a single side indicator plate with mechanism, screw pack, plastic template and instructions.

- Kits available for use on sectional trim installations only
- Can only be used with H or R roses. Roses greater than 3-1/4" in diameter cannot be used.
- L and LT privacy functions will use a coin turn for emergency override

The following chart details the functions that can be accommodated.

Best® Function	Illustration	Description	Outside	Inside
L		Privacy F19	 ABE193	 ABE194
LT		Privacy		
AB		Office F20	 ABE190*	
AT		Office F04		
RD		Classroom DL F29		
TA		Dormitory F12		
TD		Dormitory		
IND		Intruder F33		
INL		Intruder F32		 ASC190*

*Cylinder not included. Accepts a standard 1-1/8" mortise cylinder.

Function numbers, illustrations and descriptions above are from the Best® 40H series catalog. Refer to that catalog for more information and function details.

Premier Product

Indicator Option Codes

Mortise indicator option codes are designed to convey wording and color in one simple code.



V10



V40



V20



V50



V30



V60

Option Code	Wording	Color
V10	Unlocked/Locked	Green/Red
V20	Vacant/Occupied	Green/Red
V30	Icons Only	Green/Red
V40	Unlocked/Locked	White/Red
V50	Vacant/Occupied	White/Red
V60	Icons Only	White/Red

How to Order

To order, specify by model number. Door thickness and indicator option code must be specified with each kit. Competitor indicator kits are handed and easily field reversible. All units are shipped from the factory with a default handing. Handing must be field verified and adjusted as needed per product installation instructions.

Best®

Model Number	Door Thickness	Finish	Option Code
ABE190	1-3/4"	626	V10

NOTE: Indicators for both sides of the door require two kits.

The ASSA ABLOY Group is the global leader in access solutions. Every day, we help billions of people experience a more open world.

ASSA ABLOY Opening Solutions leads the development within door openings and products for access solutions in homes, businesses and institutions. Our offering includes doors, frames, door and window hardware, mechanical and smart locks, access control and service.



ASSA ABLOY

Arrow Lock & Door Hardware
225 Episcopal Road
Berlin, CT 06037
Customer Service: 1-800-327-8539
Technical Product Support: 1-800-327-8539 X2
www.arrowlock.com



ASSA ABLOY

Experience a safer
and more open world

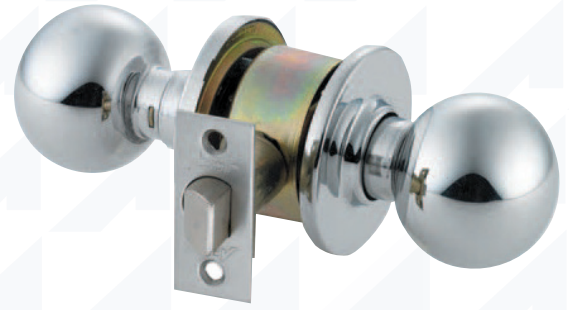

MK Series Cylindrical Locksets



Features:

Lock Chassis – Cold rolled steel with zinc dichromate finish for corrosion resistance. Requires standard 2-1/8" (54mm) bore through door.

Backset – 2-3/8" (60mm) standard. 2-3/4" (70mm).

Door Thickness – 1-3/8" (35mm) to 1-3/4" (44mm).

Latch – Brass with 1/2" (13mm) throw. Latch housing is steel, with zinc dichromate finish for corrosion resistance. 7/8" (22mm) bore in edge of door is required.

Latch Front – Brass, bronze or stainless steel. Standard faceplate for 2-3/8" (60mm) backset measures 2-1/4" (57mm) x 1" (25mm) with a flat front, for 2-3/4" (70mm) backset standard faceplate measures 2-1/4" (57mm) x 1-1/8" (29mm) with beveled front 1/8" (3mm) in 2" (51mm).

Strike – Brass, bronze or stainless steel. Standard "T" strike measures 2-3/4" (70mm) x 1-1/8" (29mm). Optional ANSI A115.1 strike measures 4-7/8" (124mm) x 1-1/4" (32mm). All strikes have a 1-1/4" (32mm) lip to center dimension.

Handing – Reversible.

Cylinder – Standard : Solid brass, 6-pin, pinned 5, 2 brass keys. Options: Arrow A or sectional keyways, Schlage C keyway, master keying, prep for small format interchangeable core cylinder (cylinder not included).

Finishes:

Arrow Code	BHMA	U.S. Equiv.	Finish Description	
605	605	US3	Bright Brass	
606	606	US4	Satin Brass	
609	609	US5	Antique Brass	
612	612	US10	Satin Bronze	
613	613	US10B	Dark Oxide Bronze, Oil Rubbed	

Arrow MK Series offer the designer, architect and contractor simple solutions to accessibility requirements. Their clean designs, architectural finishes and available functions make them ideal for commercial applications where heavy duty grade one hardware may not be necessary.

Certification:



All Arrow MK Series locks are U.L. and c.U.L. listed for use on 3 hour, A label or lesser doors and are certified to conform to the requirements of ANSI/BHMA A156.2, Series 4000, Grade 2.

Arrow Code	BHMA	U.S. Equiv.	Finish Description	
613E	613E	US10BE	Dark Oxide Bronze, Equivalent	
619	619	US15	Nickel Plated	
625	613	US26	Bright Chromium Plated	
626	626	US26D	Satin Chromium Plated	



WARNING
 This product can expose you to lead which is known to the state of California to cause cancer and birth defects or other reproductive harm. For more information go to www.P65warnings.ca.gov.

MK Series Cylindrical Locksets

Design:

Ball - BD

Knob: B Wrought

Rose: D Wrought

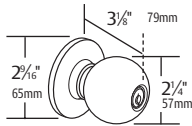

Tudor - TA

Knob: T Wrought

Rose: A Wrought

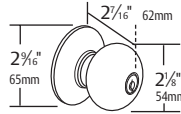

Darrin - DD

Knob: D Wrought

Rose: D Wrought

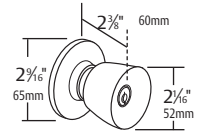

Interchangeable Core:

- Look for this symbol to indicate when product is available in the small format interchangeable core. Supplied less core but packed with 6 and 7 pin tailpieces. Suffix "IC" to request Small Format Interchangeable Core prep.

Cylinder Options:

- Cylinder** – Standard: Solid brass, 6-pin, pinned 5, 2 brass keys. Options: Arrow A or sectional keyways, Schlage C keyway, master keying, prep for small format interchangeable core cylinder (cylinder not included).

Functions:

ARROW STANDARD	ANSI/FED#	FUNCTION		DESCRIPTION
MK01	F75/161N, 160N	Passage		Latch bolt operated by knob from either side at all times.
MK02	F76/161L, 160L	Privacy		Latch bolt operated by knob from either side. Outside knob is locked by push button inside and unlocked by emergency release outside, operating inside knob or closing door.
MK03	F111	Communicating Passage		Dead locking latch bolt operated by knob one side only at all times. Non removable blank trim outside.
MK04	F77/161P, 160P	Patio		Dead locking latch bolt operated by knob from either side. Outside knob is locked by push button inside and unlocked by operating inside knob or closing door. Do not use on doors in rooms that have no other entrance.
MK05	F78/161M, 160M	Communicating		Dead locking latch bolt operated by knob from either side. Turn button on either side locks or unlocks opposite knob. Do not use on doors in rooms that have no other entrance.
MK08		Single Dummy Trim		Rigid trim for one side of door only. Used as pull or to match active trim.
MK11	F109 (F81 & F82)/161A, 160A	Entrance/Office		Dead locking latch bolt operated by knob from either side except when outside knob is locked by pushing turn button inside. Key outside or operating inside knob releases turn button unlocking outside knob except when turn button has been rotated to keep outside knob locked. Inside turn button must be manually operated to unlock outside knob. Inside knob always operates latch bolt.
MK12	F86/161D, 160D	Storeroom		Dead locking latch bolt operated by key in outside knob or by operating inside knob. Outside knob is always inoperable.
MK13	F82A/161B, 160B	Exterior		Dead locking latch bolt operated by knob from either side except when outside knob is locked by push button inside. When outside knob is locked, operating key in outside knob or operating inside knob unlocks push button and retracts latch bolt. Closing door does not release push button.

Indicates lever rigid at all times.

Functions:

ARROW STANDARD	ANSI/FED#	FUNCTION		DESCRIPTION
MK14	F92/161E, 160E	Service Station		Dead locking latch bolt operated by knob from either side except when outside knob is locked by push button inside. Key outside, operating inside knob or closing door releases push button unlocking outside knob except when slotted push button is in a locked position. Inside knob always operates latch bolt.
MK17	F84/161R, 160R	Classroom		Dead locking latch bolt operated by knob from either side except when outside knob is locked from outside by key. When outside knob is locked, latch bolt is operated by inside knob.
MK18	F113	Communicating Classroom		Dead locking latch bolt operated by knob one side only except when knob is locked by key. Non removable blank trim outside.
MK31	F80/161S, 160S	Communicating		Dead locking latch bolt operated by knob from either side. Turning key in either knob locks or unlocks its own knob independently. Do not use on doors in rooms that have no other entrance.
MK32		Public Entrance		Dead locking latch bolt operated by knob from either side except when outside knob is locked by key from inside. When outside knob is locked, latch bolt is retracted by key in outside knob or by operating inside knob.
MK33		Asylum		Dead locking latch bolt operated by key in knob from either side. Both knobs always inoperable.
MK34		Exterior		Dead locking latch bolt operated by key from outside or by knob from inside except when inside knob is locked by key from inside knob. Outside knob is always inoperable.

 Indicates lever rigid at all times.

Latches & Strikes:

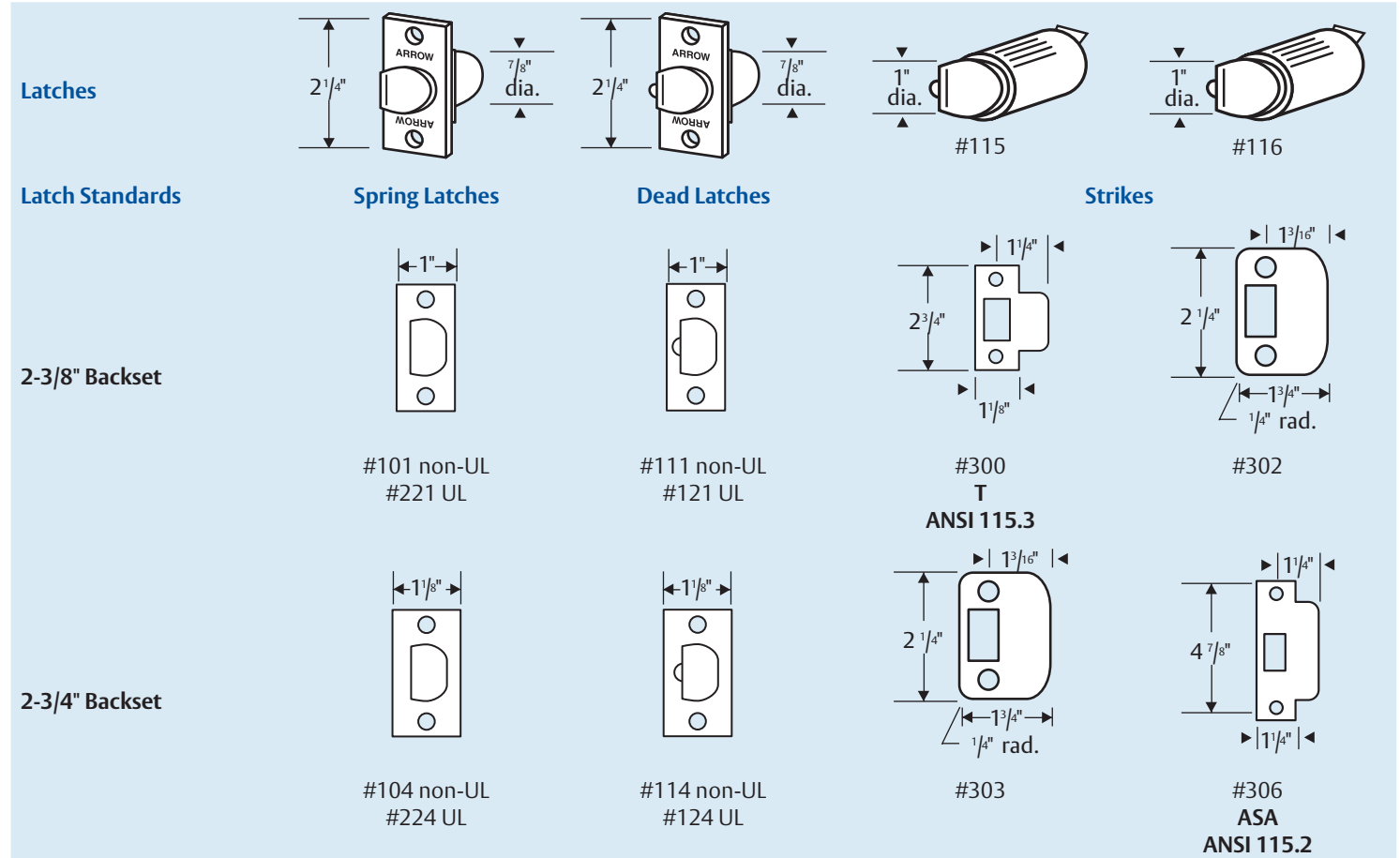

Boxes:

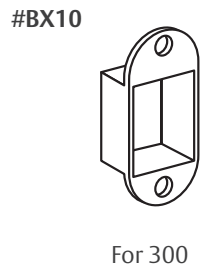
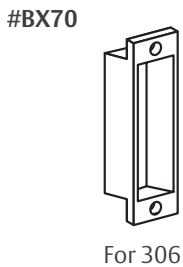

Suggested Specification:

All locksets shall be MK Series Cylindrical locksets as supplied by Arrow Lock company.

Locksets shall meet ANSI/BHMA requirements for Series 4000, Grade 2, and shall be U.L. and c.U.L. listed for 3 hour, A label openings.

Lockset shall be non-handed. Lockset shall have no exposed screws. Chassis mounting screws may be accessed only when knob and rose are removed.

Trim shall consist of wrought brass or bronze knobs with wrought brass or bronze rose scalps.

Disassembly of lockset for cylinder removal shall not be required.

Cylinder shall be changed by removing the knob.

All products shall be of one manufacturer.

All locksets shall carry a one year limited warranty.

Ordering Example:

Example: To order a MK Series classroom function lockset with a BD design, satin chrome finish, with an ASA strike and 2-3/4" backset, keyed different:

Specify:

Standard:

Series	Function	Design	Finish	Strike	Latch	Keying	Options (if required)
MK	17	BD	26D	306	124	KD	XXX

Installation:

161 prep for retrofit and secure installation.

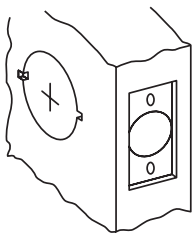

The ASSA ABLOY Group is the global leader in access solutions. Every day, we help billions of people experience a more open world.

ASSA ABLOY Opening Solutions leads the development within door openings and products for access solutions in homes, businesses and institutions. Our offering includes doors, frames, door and window hardware, mechanical and smart locks, access control and service.



ASSA ABLOY

Arrow Lock & Door Hardware
225 Episcopal Road
Berlin, CT 06037
Customer Service: 1-800-327-8539
Technical Product Support: 1-800-327-8539 X2
www.arrowlock.com



ASSA ABLOY

Experience a safer
and more open world

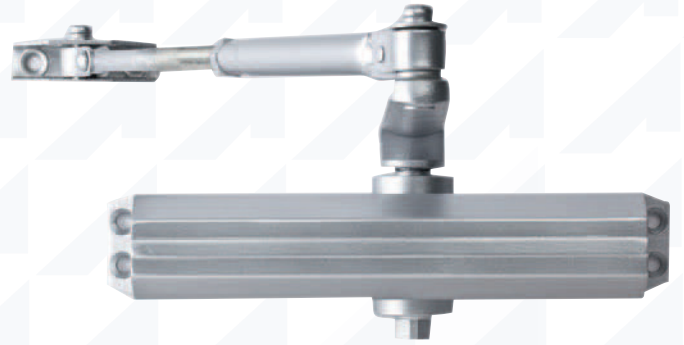

DCN300 Series Door Closers



Features:

- Cast aluminum body.
- Hardened steel rack and pinion.
- High tensile steel springs.
- Staked valves
- Two non-critical adjusting valves (sweep and latch) control closing speed.
- Backcheck intensity valve.
- All temperature fluid.
- Full plastic cover available (sold separately).
- Non-handed for regular, top jamb and parallel arm mount applications.
- Hold open arm available on adjustable closers - Specify: DCN314-1 or DCN325-1.
- Supplied with fully threaded wood screws, machine screws and thru-bolts for 1-3/4" thick doors.
- Packaging: 3 boxes per carton.
- Warranty: 5 year limited.

The Arrow DCN300 Series surface applied door closers are an economical value for customers requiring convenience and security in an affordable package. They are ideally suited for retail or office buildings.

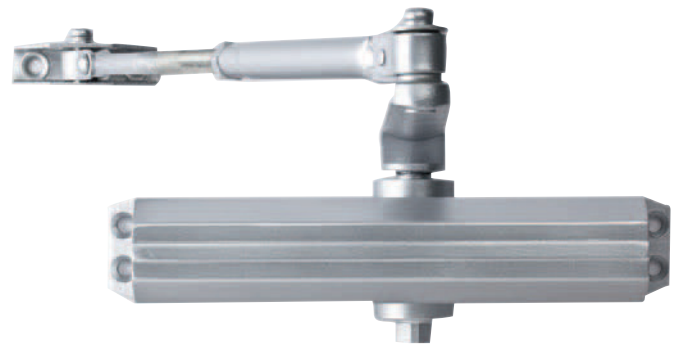

Certification & Compliance:



Look for the universal symbol next to Arrow products that comply with ADA accessibility requirements.

- UL/cUL listed.
- UL10C listed for positive pressure to comply with UBC-72 (1997).
- ANSI A156.4 Grade 1 certified.
- Adjustable size closers may be adjusted to meet requirements of ADA and ANSCI ICC A 117.1.

Finishes:

Arrow Code	Finish Description	
689	Aluminum	
690	Dark Bronze	
693	Black	



This product can expose you to lead which is known to the state of California to cause cancer and birth defects or other reproductive harm. For more information go to www.P65warnings.ca.gov.

WARNING

This product can expose you to lead which is known to the state of California to cause cancer and birth defects or other reproductive harm. For more information go to www.P65warnings.ca.gov.

DCN300 Series Door Closers

Sizes (Adjustable):

- DCN314 – Adjustable sizes 1 through 4
- DCN325 – Adjustable sizes 2 through 5

INTERIOR DOOR WIDTH	24" (610mm)	30" (762mm)	34" (865mm)	38" (965mm)	48" (1219mm)	54" (1372mm)	60" (1524mm)
Regular Arm & Top Jamb	Size 1	Size 2	Size 3	Size 4	Size 5	Size 6	
Parallel Arm	Size 2	Size 3	Size 4	Size 5	Size 6		
EXTERIOR (& VESTIBULE) DOOR WIDTH	24" (610mm)	30" (762mm)	36" (914mm)	42" (1067mm)	48" (1219mm)		
Regular Arm & Top Jamb	Size 3	Size 4	Size 5	Size 6			
Parallel Arm	Size 4	Size 5	Size 6	Size 3			

Design:

Regular Arm Installation

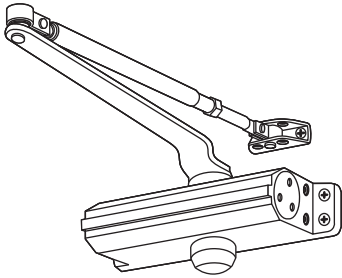

Top Jamb Installation

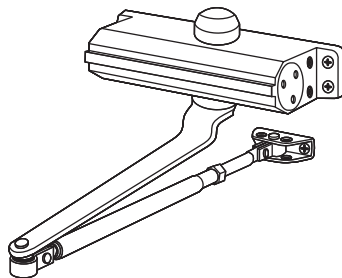

Parallel Arm Installation

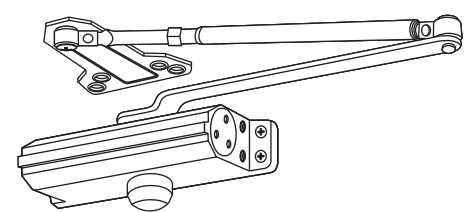

Regular Arm Installation

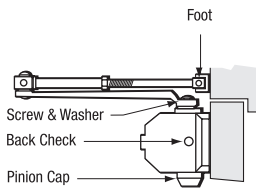
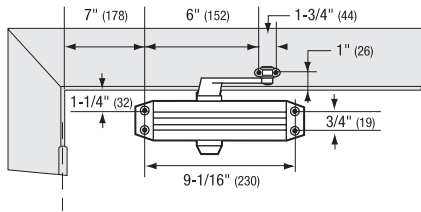

Top Jamb Installation

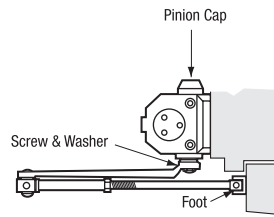
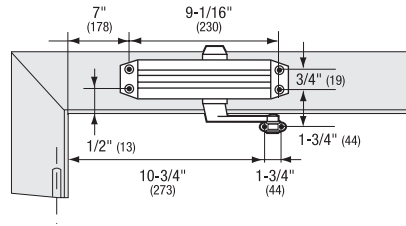

Parallel Arm Installation

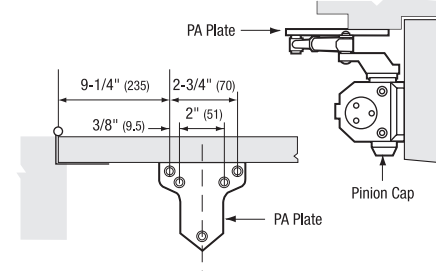
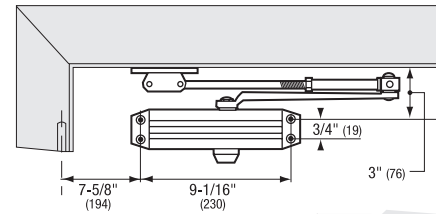

Ordering Example:

Quantity	Part Number	Finish
20	DCN314-1	689

Models: No DCN314 or DCN325

Models	Description
DCN314	Size 1-4, Non-Hold Open, Tri-Pack
DCN314-1	Size 1-4, Hold Open, Tri-Pack
DCN325	Size 1-6, Non-Hold Open, Tri-Pack
DCN325-1	Size 1-6, Hold Open, Tri-Pack

Parts & Accessories:

Series	Description
DCN3CVR	Full Plastic Cover, Screw Pack, 1-3/8" Thru-Bolts
DCNTB2	Thru-bolts 2-1/4"

NOTE:

Specify Finish when placing order: 689, 690, 693

DCN300 Series Door Closers



ASSA ABLOY

The ASSA ABLOY Group is the global leader in access solutions. Every day, we help billions of people experience a more open world.

ASSA ABLOY Opening Solutions leads the development within door openings and products for access solutions in homes, businesses and institutions. Our offering includes doors, frames, door and window hardware, mechanical and smart locks, access control and service.



ASSA ABLOY

Arrow Lock & Door Hardware
225 Episcopal Road
Berlin, CT 06037
Customer Service: 1-800-327-8539
Technical Product Support: 1-800-327-8539 X2
www.arrowlock.com



ASSA ABLOY

Experience a safer
and more open world

5016N Series Door Closers



Features:

- Cast aluminum body.
- Hardened steel rack and pinion.
- High tensile steel springs.
- Staked valves.
- Two non-critical adjusting valves (sweep and latch) control closing speed.
- Backcheck intensity valve.
- All temperature fluid.
- Available with a full plastic cover or a slim plastic cover (specify "S" suffix).
- Non-handed for regular, top jamb and parallel arm mount applications.
- Hold open arm available on adjustable closers.
- Available with optional delayed action adjusted with separate independent valve. Delays door closing to allow unimpeded passage through the opening. Specify "D" suffix.
- Supplied with machine screws, fully threaded self-reaming/tapping screws, sleeve nuts and thru-bolts for 1-3/4" thick doors.
- Packaging: one per box and four boxes per carton.
- 10 year limited warranty.

The Arrow 5016N Series Surface Applied Door Closers are ideal for use in commercial and institutional facilities where there is a demand for reliability and flexibility. Arrow offers multiple options for compliance with barrier-free codes for interior or exterior doors.



Finishes:

Arrow Code	Finish Description	
689	Aluminum, Specify AL	
690	Dark Bronze, Specify DBZ	
691	Light Bronze, Specify LBZ	
696	Gold, Specify GL	
693	Black, Specify BLK	

Certification & Compliance:

Look for the universal symbol next to Arrow products that comply with ADA accessibility requirements.

- listed.
- certified.
- Meets the requirements of UL10C Positive Pressure up to 3 hours.
- /BHMA A117.1.
- /BHMA A156.4, Grade 1.
- Meets ADA requirements (Americans with disabilities Act).

WARNING

This product can expose you to lead which is known to the state of California to cause cancer and birth defects or other reproductive harm. For more information go to www.P65warnings.ca.gov.

5016N Series Door Closers



ASSA ABLOY

Sizes (Adjustable):

- 5016N– Adjustable sizes 1 through 6, Standard Armor Hold Open Arm.

INTERIOR DOOR WIDTH	24" (610mm)	30" (762mm)	34" (865mm)	38" (965mm)	48" (1219mm)	54" (1372mm)	60" (1524mm)
Regular Arm & Top Jamb	Size 1	Size 2	Size 3	Size 4	Size 5	Size 6	
Parallel Arm	Size 2	Size 3	Size 4	Size 5	Size 6		
EXTERIOR (& VESTIBULE) DOOR WIDTH	24" (610mm)	30" (762mm)	36" (914mm)	42" (1067mm)	48" (1219mm)		
Regular Arm & Top Jamb	Size 3	Size 4	Size 5	Size 6			
Parallel Arm	Size 4	Size 5	Size 6	Size 3			

Design:

Regular Arm Installation

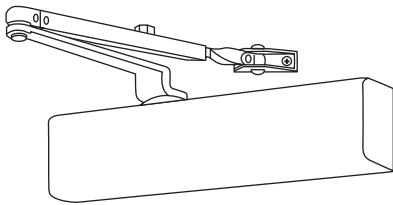

Top Jamb Installation

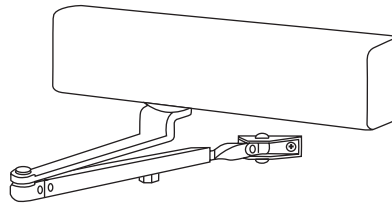

Parallel Arm Installation

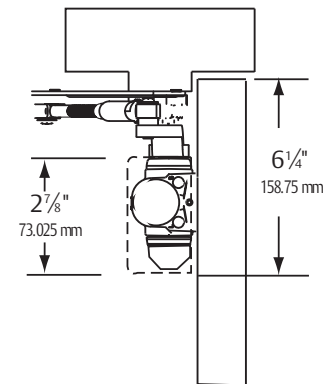
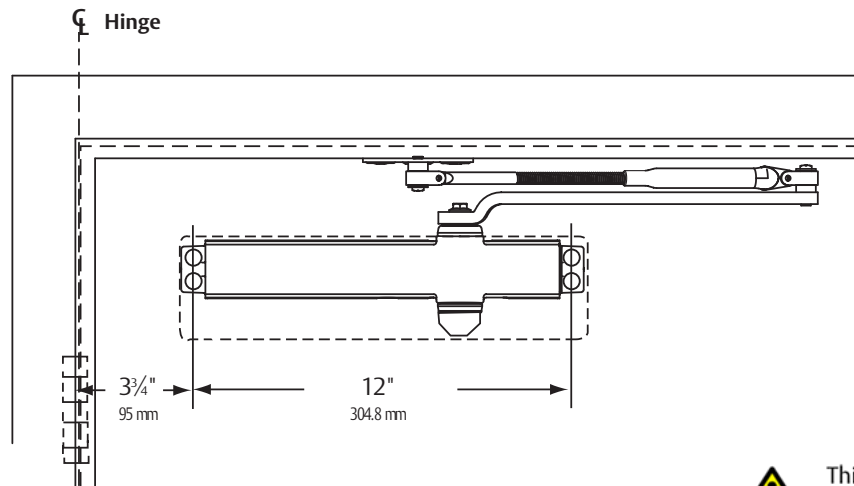
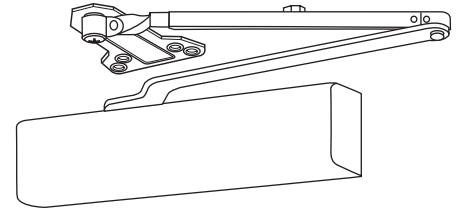

This product can expose you to lead which is known to the state of California to cause cancer and birth defects or other reproductive harm. For more information go to www.P65warnings.ca.gov.

Ordering Example:

Quantity	Part Number	Finish
20	5016N	AL

Tri-pack Models - Size 1-6

Model	Description
5016NS	Standard non-hold open arm with slim plastic cover
5016N	Standard non-hold open arm with full plastic cover
5016NSD	Standard non-hold open arm with slim plastic cover, delayed action
5016ND	Standard non-hold open arm with full plastic cover, delayed action
5016NSH	Hold open arm with slim plastic cover
5016NH	Hold open arm with full plastic cover
5016NSHD	Hold open arm with slim plastic cover, delayed action
5016NHD	Hold open arm with full plastic cover, delayed action

Door Saver Parallel Arm Models - Size 1-6

Model	Description
5016NPS	Standard non-hold open arm with slim plastic cover
5016NP	Standard non-hold open arm with full plastic cover
5016NPSD	Standard non-hold open arm with slim plastic cover, delayed action
5016NPD	Standard non-hold open arm with full plastic cover, delayed action
5016NPSH	Hold open arm with slim plastic cover
5016NPH	Hold open arm with full plastic cover
5016NPSHD	Hold open arm with slim plastic cover, delayed action
5016NPHD	Hold open arm with full plastic cover, delayed action

NOTE:

Specify Finish when placing order: AL, DBZ, LBZ, GL, BLK

5016N Series Door Closers



ASSA ABLOY

The ASSA ABLOY Group is the global leader in access solutions. Every day, we help billions of people experience a more open world.

ASSA ABLOY Opening Solutions leads the development within door openings and products for access solutions in homes, businesses and institutions. Our offering includes doors, frames, door and window hardware, mechanical and smart locks, access control and service.



ASSA ABLOY

Arrow Lock & Door Hardware
225 Episcopal Road
Berlin, CT 06037
Customer Service: 1-800-327-8539
Technical Product Support: 1-800-327-8539 X2
www.arrowlock.com



ASSA ABLOY

Experience a safer
and more open world

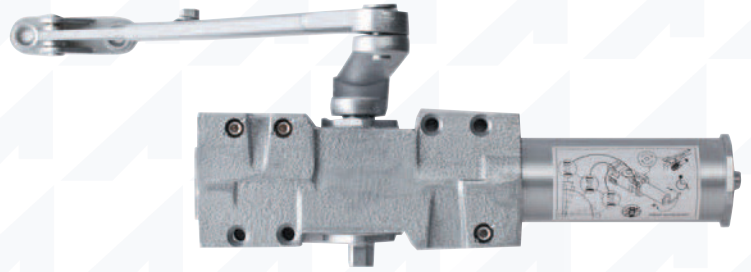

DCN500 Series Door Closers



Features:

- Heavy duty cast iron body.
- Hardened steel rack and pinion.
- High tensile steel springs.
- Staked valves
- Two non-critical adjusting valves (sweep and latch) control closing speed.
- Backcheck intensity valve.
- All temperature fluid.
- Full plastic cover standard.
- Non-handed for regular, top jamb and parallel arm mount applications.
- Hold open arm available on adjustable closers.
- Supplied with fully threaded self-reaming/tapping screws, sleeve nuts and thru-bolts for 1-3/4" thick doors.
- DCN516-1 Series door closers are supplied with a hold open arm.
- DCN516-2 has a heavy duty parallel arm with a stop feature for door openings between 90° and 110°.
- DCN516-3 has a heavy duty parallel arm with a stop and thumb turnhold open feature for door openings between 90° and 110°.
- Packaging: three boxes per carton.
- 10 year limited warranty.

The Arrow DCN500 Series Heavy Duty Surface Applied Door Closers are ideal for Institutions or other high traffic applications. The DCN500 is designed for end users looking for value and versatility in a rugged design making this series suitable for a wide variety of applications.

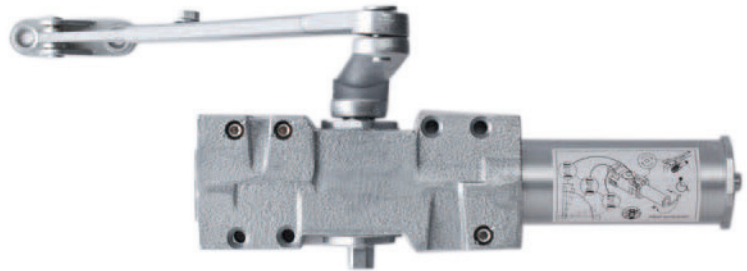

Certification & Compliance:



Look for the universal symbol next to Arrow products that comply with ADA accessibility requirements.

- UL/cUL listed.
- UL10C listed for positive pressure
- Meets requirements of ANSI/BHMA 156.4 Grade 1
- Meets ADA requirements (Americans with disabilities Act).
- ANSI ICC A117.1

Finishes:

Arrow Code	Finish Description	
689	Aluminum	
690	Dark Bronze	
693	Black	



WARNING
 This product can expose you to lead which is known to the state of California to cause cancer and birth defects or other reproductive harm. For more information go to www.P65warnings.ca.gov.

DCN500 Series Door Closers

Sizes (Adjustable):

• DCN516 closers are adjustable for spring sizes 1 through 6.

INTERIOR DOOR WIDTH	24" (610mm)	30" (762mm)	34" (865mm)	38" (965mm)	48" (1219mm)	54" (1372mm)	60" (1524mm)
Regular Arm & Top Jamb	Size 1	Size 2	Size 3	Size 4	Size 5	Size 6	
Parallel Arm	Size 2	Size 3	Size 4	Size 5	Size 6		

EXTERIOR (& VESTIBULE) DOOR WIDTH	24" (610mm)	30" (762mm)	36" (914mm)	42" (1067mm)	48" (1219mm)
Regular Arm & Top Jamb	Size 3	Size 4	Size 5	Size 6	
Parallel Arm	Size 4	Size 5	Size 6	Size 3	

Design:

Regular Arm Installation

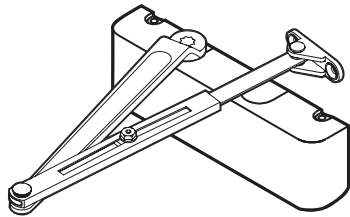

Top Jamb Installation

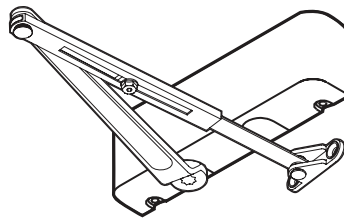

Parallel Arm Installation

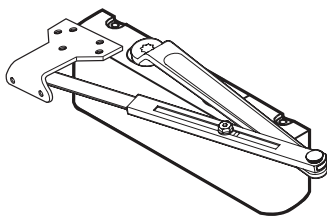

Heavy Duty Parallel Arm Installation

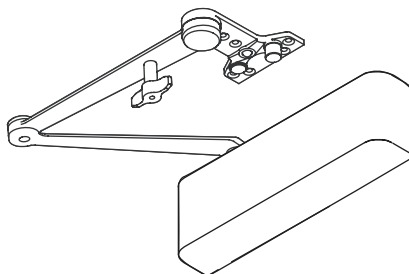

Regular Arm Installation

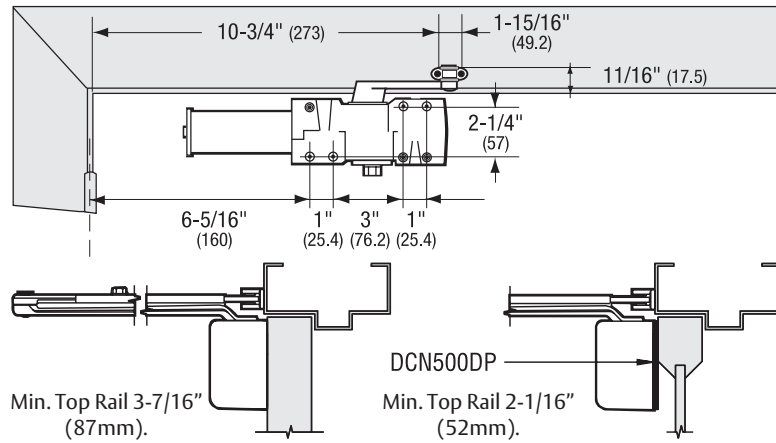

Parts:

Cover with Screw Pack
 • DCN500COV

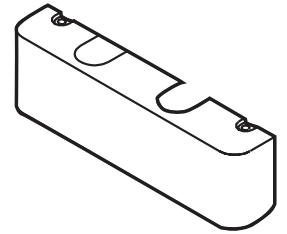

Non-Hold Open Arm (Standard with)
 • DCN516

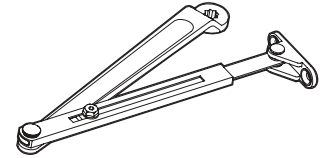

(To order separately)
 • DCN500A

Hold Open Arm (Standard with)
 • DCN516-1

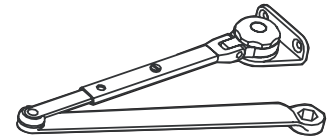

(To order separately)
 • DCN500A1

Parallel Arm Installation (180° maximum door swing template illustrated)

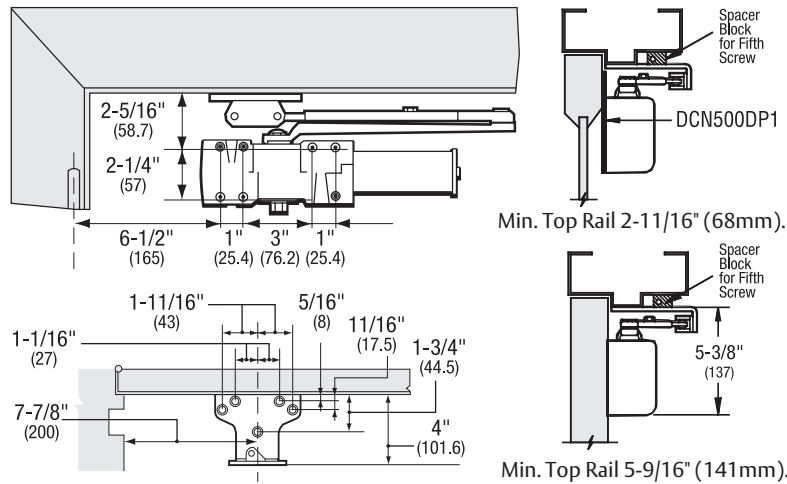

Drop Plates:

Regular Arm Application
 • DCN500DP

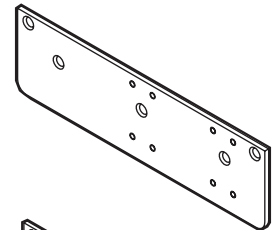

Parallel Arm Application
 • DCN500DP1

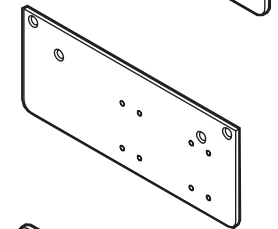

Top Jamb Installation

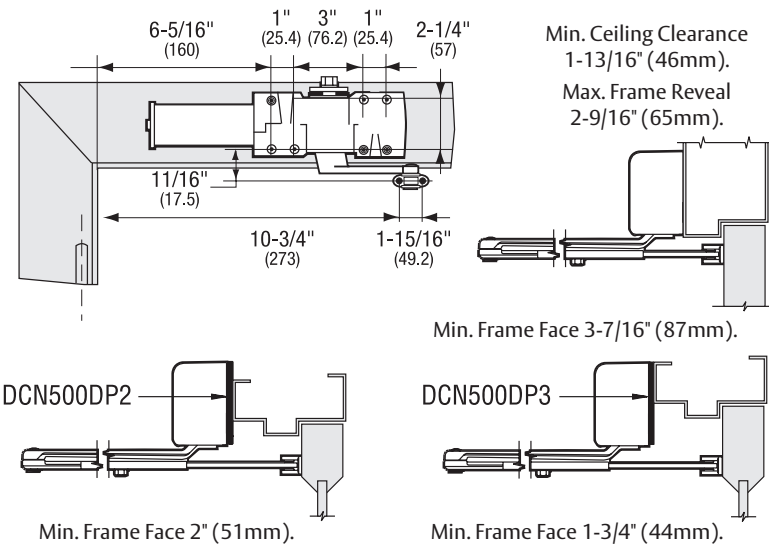

Top Jamb Application
 • DCN500DP2

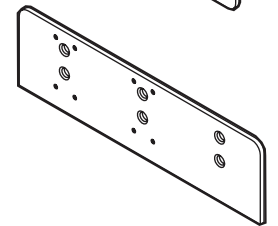

Top Jamb Low Ceiling Application
 • DCN500DP3

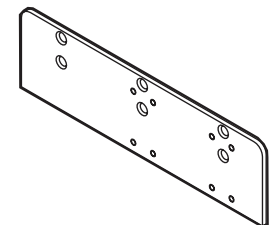

Heavy Duty Parallel Arm with a choice:

- DCN516-2 - Non-Hold Open Arm with Stop Feature
- DCN516-3 - thumbturn Hold Open Arm with Stop Feature
- Door Closer can be installed to stop door at: 85°, 90°, 100° or 110° of door swing.

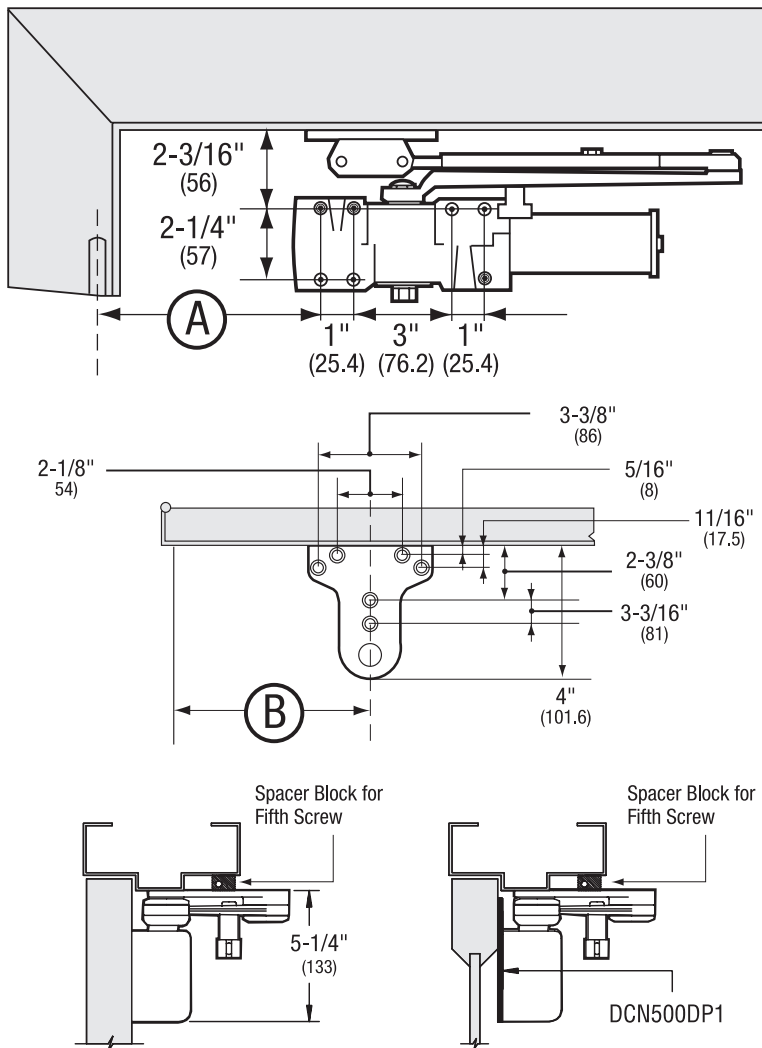

Parts:

- Heavy Duty Parallel Arm
Non-Hold Open with Stop Feature
(Standard with)
- DCN516-2

- (To order separately)
- DCN500A2

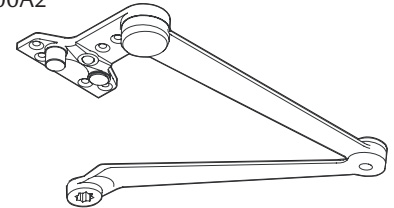

- Heavy Duty Parallel Arm with Thumbturn
Non-Hold Open with Stop Feature (Standard with)
- DCN516-3

- (To order separately)
- DCN500A3

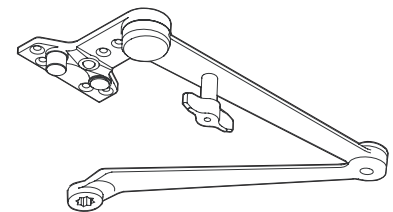

- Drop Plate
- DCN500DP1

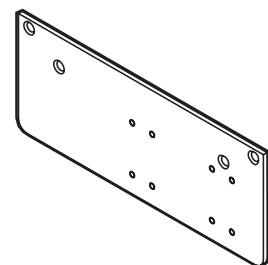

"A" Dimension	9-1/2" (241)	8-3/4" (222)	7-5/8" (194)	6-5/8" (168)
"B" Dimension	11-1/8" (283)	10-1/2" (267)	9-1/4" (235)	8-3/8" (213)
Degree of Stop	85°	90°	100°	110°

DCN500 Series Door Closers



ASSA ABLOY

Ordering Example:

Quantity	Part Number	Finish
20	DCN516-3	689

Complete Units:

Series	Description	Size
DCN516	Non-Hold Open Arm with PA Bracket, Full Plastic Cover, Screw Pack, 1-3/4" Thru-bolts	1-6
DCN516-1	Hold Open Arm with PA Bracket, Full Plastic Cover, Screw Pack, 1-3/4" Thru-bolts	1-6
DCN516-2	Heavy-Duty Dead Stop NHO, Full Plastic Cover, Screw Pack, 1-3/4" Thru-bolts	1-6
DCN516-3	Heavy-Duty Dead Stop HO, Full Plastic Cover, Screw Pack, 1-3/4" Thru-bolts	1-6

Parts & Accessories:

Series	Description	Size
DCN500CV	Full Plastic Cover	1-6
DCN500DP	Drop Plate - Regular	1-6
DCN500DP1	Drop Plate - Parallel Arm	1-6
DCN500DP2	Drop Plate - Top Jamb	1-6
DCN500DP3	Drop Plate - Top Jamb, Flush Ceiling	1-6
DCNTB1	Thru-bolts 1-3/4"	1-6
DCNTB2	Thru-bolts 2-1/4"	1-6
DCN500SP	Standard Screw Pack	1-6
DCN500A	Standard Non-Hold Open Arm	1-6
DCN500A1	Standard Hold Open Arm	1-6
DCN500A2	Heavy-Duty Dead Stop Arm Non-Hold Open	1-6
DCN500A3	Heavy-Duty Dead Stop Arm Hold Open	1-6
DCN500A4	Heavy-Duty Non-Hold Open Cushion Arm Kit	1-6
DCN500A5	Heavy-Duty Hold Open Cushion Arm Kit	1-6

NOTE:

Specify Finish when placing order: 689, 690, 693

DCN500 Series Door Closers



ASSA ABLOY

The ASSA ABLOY Group is the global leader in access solutions. Every day, we help billions of people experience a more open world.

ASSA ABLOY Opening Solutions leads the development within door openings and products for access solutions in homes, businesses and institutions. Our offering includes doors, frames, door and window hardware, mechanical and smart locks, access control and service.



ASSA ABLOY

Arrow Lock & Door Hardware
225 Episcopal Road
Berlin, CT 06037
Customer Service: 1-800-327-8539
Technical Product Support: 1-800-327-8539 X2
www.arrowlock.com



ASSA ABLOY

Experience a safer
and more open world

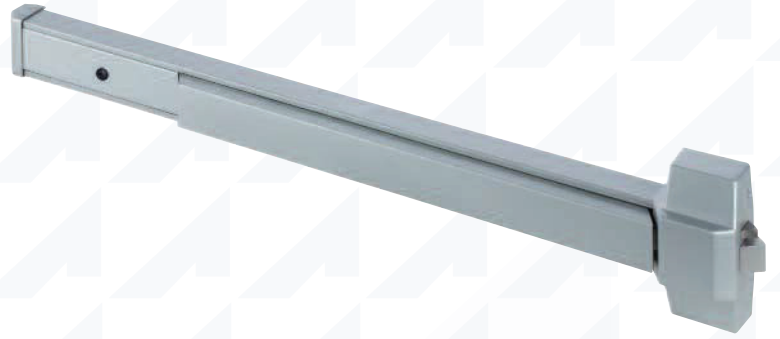

ED910 Series Exit Devices



ED910 Series Exit Devices



PROFESSIONAL REPLACEMENT PRODUCT

ASSA ABLOY

Features:

- **Chassis** - Stamped steel materials.
- **Chassis Cover** - Cast zinc.
- **Door Type** - Fits 1 3/4" (44.5mm) doors standard.
- **Door Width** - For 48" doors, can be cut for a minimum 43" door width. For 36" doors, can be cut for a minimum 31" door width.
- **Stile** - 4-1/2" (114.30mm) minimum.
- **Mounting** - Wood and machine screws furnished standard.
- **Handing** - Reversible.
- **Dogging** - Hex-type hold down.
- **Latchbolt** - Stainless Steel.
- **Rail Assembly** - Powder coated steel, stainless steel optional.
- **Packaging** - 4 units per master carton.
- **Strike** - Surfaced applied, nylon coated.

The Arrow ED910 Series Door Closer is a value exit device for everyday solutions. Ideal for high traffic or high vandalism areas, is BHMA Grade One certified and designed to replace or upgrade existing devices. Available with an extended 10-year warranty.



Finishes:

BHMA	Arrow Code	Finish Description	
689	AL	Aluminum (sprayed finish)	
630	32D	Satin Stainless Steel	
613E	10BE	Dark Oxide Bronze Equivalent	

Certification & Compliance:

- ANSI/BHMA A156.3, Grade 1
- Underwriters Laboratories (UL and CUL) Listed for accident hazard (panic) standard.
- All exit devices comply with life safety code NFPA 101



For 36" Door Widths:

Part No.	Description
ED910-36.AL	Aluminum Finish (sprayed)
ED910-36.32D	Satin Stainless Steel Finish
ED910-36.613E	Dark Bronze Finish (sprayed)

ES90 Strike:

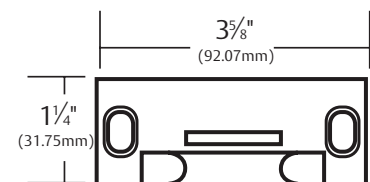

For 48" Door Widths:

Part No.	Description
ED910-48.AL	Aluminum Finish (sprayed)
ED910-48.32D	Satin Stainless Steel Finish
ED910-48.613E	Dark Bronze Finish (sprayed)

Parts:

Part No.	Description
ES90	Strike Pack
ES9-201	Screw Pack
ES9CAP.AL	End Cap (aluminum)
ES9CAP.613E	End Cap (dark bronze)

WARNING

This product can expose you to lead which is known to the state of California to cause cancer and birth defects or other reproductive harm. For more information go to www.P65warnings.ca.gov.

ED910 Series Exit Devices

PROFESSIONAL REPLACEMENT PRODUCT

Exit Device Trim:

Matching trim available to complement: cylindrical locks, mortise locks, exit devices, and alarms.

Functions:

- **Passage** - Trim always operative.
- **Storeroom** - Key retracts latch, key removable only when trim is locked.
- **Classroom** - Key locks/unlocks trim.

Finish:

- **Knobs** - US3, US4, US10, US10B, US26D.
- **Levers** - USD26D, US10B.
- **Plate** - AL, BRZ.

Ordering Information:

Trim Type	Passage	Storeroom	Classroom
Lever	SRX01	SRX82	SRX87
Ball Knob	BD01	BD12	BD17
Tudor Knob	TA01	TA12	TA17

Trim Type	Blank Plate	Dummy Pull	Storeroom Plate
Plate	SF01	SF02	SF12

Lever Trim:

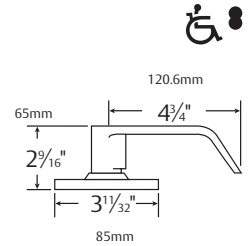

Knob Trim:

Ball BD

Knob: B Wrought
Rose: D Wrought

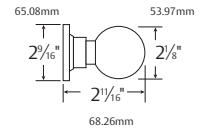

Tudor TA

Knob: T Wrought
Rose: A Wrought

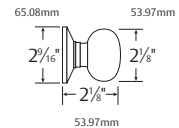
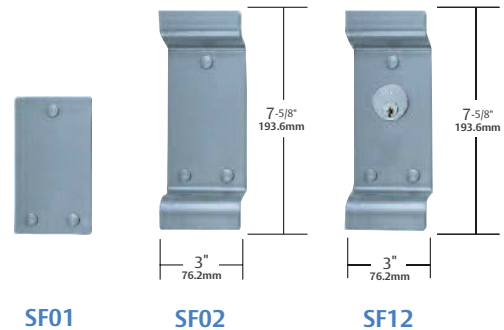

Plate Trim:



Available for small format interchangeable core.



This product can expose you to lead which is known to the state of California to cause cancer and birth defects or other reproductive harm. For more information go to www.P65warnings.ca.gov.

The ASSA ABLOY Group is the global leader in access solutions. Every day, we help billions of people experience a more open world.

ASSA ABLOY Opening Solutions leads the development within door openings and products for access solutions in homes, businesses and institutions. Our offering includes doors, frames, door and window hardware, mechanical and smart locks, access control and service.



ASSA ABLOY

Arrow Lock & Door Hardware
225 Episcopal Road
Berlin, CT 06037
Customer Service: 1-800-327-8539
Technical Product Support: 1-800-327-8539 X2
www.arrowlock.com



ASSA ABLOY

Experience a safer
and more open world



300 and 400 Series Alarmed Hardware

DISCONTINUED



300 and 400 Series Alarmed Hardware



ASSA ABLOY

300 Series Exit Alarm

General Specifications:

Chassis – Paddle, chassis and cover made from a non-ferrous alloy. Cover 12-3/4" (323.85mm) x 2" (50.8mm) x 2-5/8" (66.67mm); paddle projection 3-1/4" (88.25mm); length to end of paddle 10-3/8" (263.52mm).

Power/Electronics – 9 volt battery powered Modern solid state electronics.

Latch – 3/4" (19.05mm) latchbolt monitored by an electronic sensor switch. Any unauthorized movement of the latchbolt will cause unit to go into alarm.

Doors – For outward swinging doors 1-3/4" (44.45mm) thick with a 4" minimum stile.

Alarm/Horn – Alarm sounds for 2 minutes, shuts off and automatically rearms itself. Piercing, dual frequency pulsating horns. Rated for 90 decibels at 6 feet.

Cylinders – Inside cylinder operation to arm or disarm unit using 1-1/8" (28.57mm) mortisecylinder. (Order cylinder separately).

Hand – Reversible. Units are packed RHRB.

Features:

Model 330 – Auto relatching.

Red LED indicator flashes when violation occurs. Light continues to flash beyond alarm cycle and can only be turned off by the inside key.

One chassis will accept all available trim options.

Unit must be activated to test available battery power.

Low battery alert feature causes unit to chirp intermittently to indicate low battery power.



Finishes:

Powder coated painted finishes: AL, BRZ, RD.

Hardware finishes: US10, US10B, US26, US26D.

Certification and Compliance:



UL listed. Designed to meet ANSI 156.5-1984 and A117.1-1980 for Accessibility Standards.

400 Series Exit Alarm

General Specifications:

Chassis – Chassis and cover made from an on-ferrous alloy, 12-3/4" (323.85mm) x 2" (50.8mm) x 2-5/8" (66.67mm)

Touchbar – Rolled steel touch bar assembly to fit 30" (762.0mm) to 36" (914.40mm) door furnished standard. Bars to fit 24" (609.60mm) to 30" (762.0mm) and 37" (939.80mm) to 48" (1219.20mm) available. Can be cut to size in the field. Specify door width.

Power/Electronics – 9 volt battery powered. Modern, solid state electronics.

Latch – 3/4" (19.05mm) latchbolt monitored by an electronic sensor switch. Any unauthorized movement of the latchbolt will cause the unit to go into alarm.

Doors – for outward swinging doors 1-3/4" (44.45mm) thick with 4" (101.60mm) minimum stile.

Horn/Alarm – Piercing, dual frequency pulsating horns. Rated for 90 decibels at 6 feet. Alarm sounds for two minutes then, shutdown and rearms automatically. A 15 second delay feature allows authorized egress without sounding alarm.

Cylinders – Inside cylinder operation to arm or disarm unit using a 1-1/8" (28.57mm) mortise cylinder. (Order cylinder separately).

Hand – Reversible. Unit is packed RHRB.

Features:

Model F430 – Fire rated.

Model 430 – Red LED indicator flashes when violation occurs. Light continues to flash beyond alarm cycle and can only be turned off by the inside key.

Units setup to accept outside cylinder operation as standard.

One chassis will accept all available trim options.

Unit must be activated to test available battery power.

Low battery alert feature causes unit to chirp intermittently to indicate low battery power.



Finishes:

Powder coated painted finishes: AL, BRZ, RD.

Hardware finishes: US10, US10B, US26, US26D.

Certification and Compliance:

Designed to meet ANSI 156.3-1984 and A117.1-1980 for Accessibility Standards.

Packed-1 each.

Visit www.arrowlock.com



ASSA ABLOY

Experience a safer
and more open world

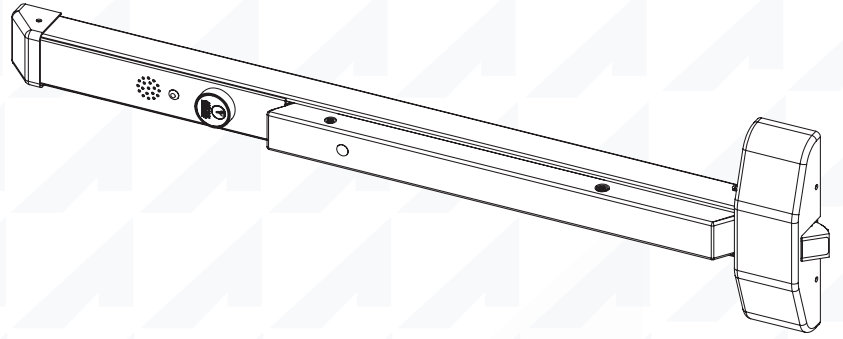

AL500 Series Alarmed Hardware



AL500 Series Alarmed Hardware



ASSA ABLOY

PREMIER PRODUCT

Features:

- Microprocessor based alarm board
- When armed, alarm sounds immediately upon rail depression
- All exit devices have tamper resistant latching (Guarded Latch)
- Battery powered - 9VDC
- 103 Db @ 8 ft pulsating horn
- Flashing red LED provides visible violation indication, reset by key only
- Low battery alert
- Field selectable continuous alarm option
- Automatic re-arming option
- Inside cylinder operation to arm or disarm unit uses a 1-1/8" (29mm) mortise cylinder with 001 cam. Cylinder ordered separately.
- UL Listed and cUL Listed
- UL Listed to Canadian Safety Standards
- Rail Monitoring and Guarded Latch are standard internal features
- Minimum door widths: E 32" only, F 32-1/4 - 36", G 36-1/4 - 48"
- See McKinney's Transfer Device Solutions Catalog for QC Hinge and cable requirements (if hard wired)

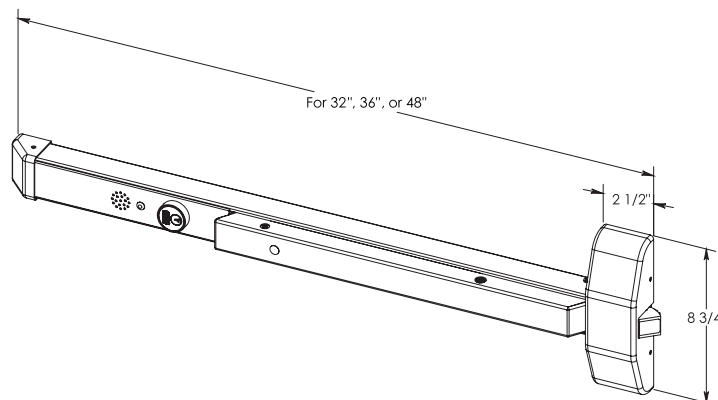

Certification & Compliance:

- Designed to meet ANSI 156.3-1984 and A117.1-1980 for Accessibility Standards.

Packed - 1 each.

Finishes:

BHMA	Arrow Code	Finish Description	
689	AL	Aluminum (sprayed finish)	
630	32D	Satin Stainless Steel	
690	BRZ	Dark Bronze Powder Coat	
BSP	BSP	Black Suede Powder Coat	
—	RD	Red Powder Coat	

WARNING

This product can expose you to lead which is known to the state of California to cause cancer and birth defects or other reproductive harm. For more information go to www.P65warnings.ca.gov.

AL500 Series Alarmed Hardware



ASSA ABLOY

PREMIER PRODUCT

AL500 Series Trim:

Exit Alarm Trim

Matching trim available to complement other series of cylindrical locks, BM Series Mortise locks, exit devices and alarms.

Ordering Information:

When ordering trim, specify design symbol and function, eg: SRX82, if specifying Sierra lever in Storeroom function.

Finishes:

Knob: US3, US4, US10, US10B, US26D

Lever: 26D, 613E

Plate: 689, 690, RD, BSP

Plate Trim:

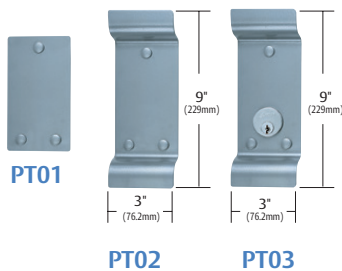

Ball BD

Knob: B Wrought
Rose: D Wrought

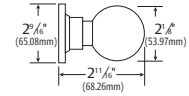

Tudor TA

Knob: T Wrought
Rose: A Wrought

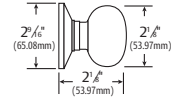

Sierra SRX

Knob: S Cast
Rose: R Wrought

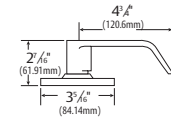

Available for small format interchangeable core.

AL500 Series Accessories:

Functions

01 Passage – Knob/lever always active. Turning knob retracts latch and puts alarm into 15 second delay mode. (Latch retraction by knob/lever sets off alarm is optional).

12/82 Storeroom – Knob/lever always rigid. Key retracts latch and puts alarm into 15 second delay mode.

17/87 Classroom – Key locks or unlocks knob/lever. Turning knob retracts latch and puts alarm into 15 second delay mode.

Options:

Automatic Rearming

- Units are provided with spring loaded on/off switch. Switch automatically returns to the on position after removal of the key.
- Alarm can never be left off.

Continuous Alarm

- Horns will sound continuously after a violation has occurred—does not shut off after 2 minute alarm cycle.
- Only disarming by key operation will quiet the alarm.
- Remote power is recommended for units with this feature.

Thru Bolts

#FS54 Specify finish: 26D, 10B, BSP

Strikes:

S38

AL500 Series standard for single door applications. Black nylon coated.

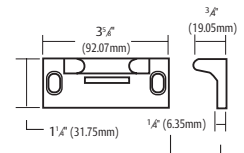

S36

AL500 Series for double door applications without a mullion. Surface applied. Black nylon coated.

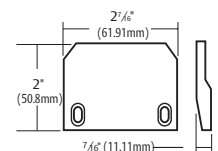

The ASSA ABLOY Group is the global leader in access solutions. Every day, we help billions of people experience a more open world.

ASSA ABLOY Opening Solutions leads the development within door openings and products for access solutions in homes, businesses and institutions. Our offering includes doors, frames, door and window hardware, mechanical and smart locks, access control and service.



ASSA ABLOY

Arrow Lock & Door Hardware
225 Episcopal Road
Berlin, CT 06037
Customer Service: 1-800-327-8539
Technical Product Support: 1-800-327-8539 X2
www.arrowlock.com



ASSA ABLOY

Experience a safer
and more open world



S1150 & S1250 Series Exit Devices



S1150 & S1250 Series Exit Devices



Classic Product

ASSA ABLOY

Certification & Compliance:

- ANSI/BHMA A156.3, Grade 1
- Americans with Disabilities Act (ADA) Compliant
- UL 305 – Standard for Panic Hardware
- Fire Exit hardware for hollow metal doors, UL and CUL listed for 3 hour, A label and lesser doors, Prefix "F" before part number.
- Fire Exit hardware for wood doors, listed up to 1-1/2 hour, B label doors.
- NFPA 101 Compliant
- ANSI/BHMA A156.41
- NFPA 80 Compliant
- ICC A117.1 Compliant

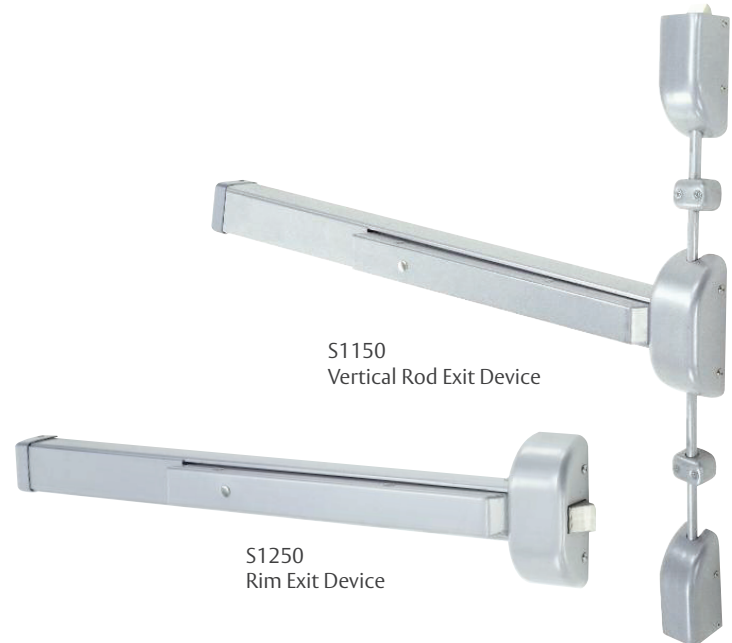

General Specifications:

	S1150	S1250
Chassis	Non-ferrous alloy - standard/Ductile iron - fire rated	Non-ferrous alloy - standard/Ductile iron - fire rated
End caps & covers	Steel	Steel
Doors	1-3/4" (44.45mm) thick wood or hollow metal 3-3/4" minimum stile for single doors 3-1/2" (88.90mm) minimum stile for double doors	1-3/4" (44.45mm) thick wood or hollow metal 4-1/2" (114.3mm) minimum stile 4-5/8" for fire-labeled devices
Handing	Reversible	Reversible
Dogging	Allen-type key standard, cylinder available.	Allen-type key standard, cylinder available.
Top/Bottom Bolts/ Latchbolt	Stainless steel 1/2" (12.7mm) throw top, 3/4" (19.05mm) bottom	3/4" (19.05mm) throw, stainless steel
Throughbolts	Order separately	Order separately
Rail Assembly	Steel	Steel
Rail Size	<ul style="list-style-type: none"> • Standard for doors 33" through 36" wide • 24 for doors 24" through 32" wide • 48 for doors 43" through 48" wide 	<ul style="list-style-type: none"> • Standard for doors 33" through 36" wide • 24 for doors 24" through 32" wide • 48 for doors 43" through 48" wide
Rods	90"-extension kits available	N/A
Trim	See trim page 4	See trim page 4
Finishes	AL, BRZ, LBZ (sprayed finishes)	AL, BRZ, LBZ (sprayed finishes)

WARNING

This product can expose you to lead which is known to the state of California to cause cancer and birth defects or other reproductive harm. For more information go to www.P65warnings.ca.gov.

S1150 & S1250 Series Exit Devices

Classic Product

Strikes – S1150 Series:

Standard & Fire Rated Top Strike - S646

Surface applied top strike. No mortise required. Nylon Coated. Furnished standard.

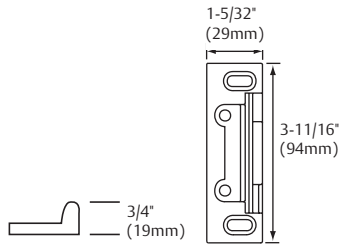

Standard Bottom Strike - S23

S23 bottom Strike surface applied to threshold or floor. Black nylon coated, furnished standard.

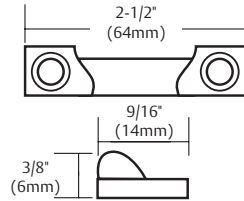

Fire Rated Bottom Strike - S655

Standard for FS1150. Flush mounted, stainless steel. Furnished with expansion shields.

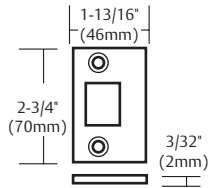

Strikes – S1250 Series:

Standard and Fire Rated Surface Strike – S38

Surface applied nylon coated.

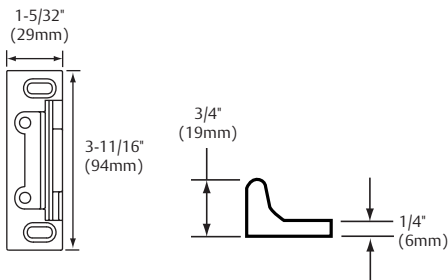

Double Door Strike - S36

Strike for double doors without mullion.

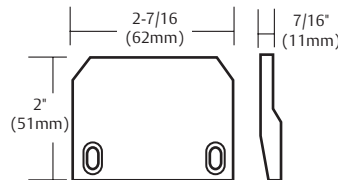

S1150 & S1250 Series Exit Devices



Classic Product

ASSA ABLOY

Parts:

Chassis Covers, End Caps & Dogging Key	Part No.
Top and bottom latch cover 1150	28-0018
Chassis cover for 1150	28-0013
Chassis cover for 1250	28-0017
End cap for 1150 & 1250	28-0012
End cap mounting bracket	68-1434
Dogging Key	97-0001
Rail Assemblies – Standard Rail, Sprayed Finish	
24"- 32" Doors	PR-24
32-1/4"- 36" Doors	PR-36
36-1/4"- 48" Doors	PR-48

Add "F" prefix for fire rated

Rail Assemblies – Rail with Cylinder Dogging, Sprayed Finish	
24"- 32" Doors	PR-24 CD
32-1/4"- 36" Doors	PR-36 CD
36-1/4"- 48" Doors	PR-48 CD
Extension Rod Kit for S1150 Series	
18 inch	VRX-18

S1150 & S1250 Exit Device Trim:

Matching trim available to complement: cylindrical locks mortise locks, exit devices, and alarms.

Functions:

Passage – Trim always operative.

Storeroom – Key retracts latch, key removable only when trim is locked.

Classroom – Key locks/unlocks trim.

Ordering Information:

Trim Type	Passage	Storeroom	Classroom
Lever	SRX01	SRX82	SRX87
Ball Knob	BD01	BD12	BD17
Tudor Knob	TA01	TA12	TA17
Plate	SF01	SF12	N/A

Finish:

Knobs: US3, US4, US10, US10B, US26, US26D

Levers: US26D, 613E

Plate: AL, BRZ, LBZ

S1150 & S1250 Series Exit Devices

Classic Product

Lever Trim:

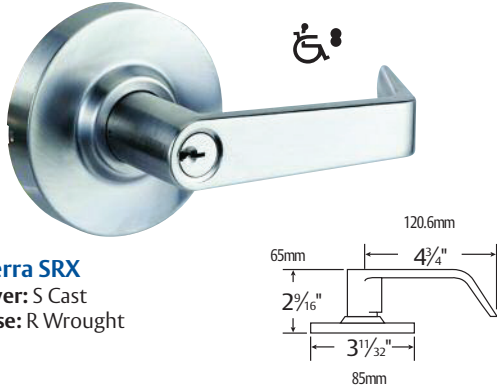

Sierra SRX
Lever: S Cast
Rose: R Wrought

Knob Trim:

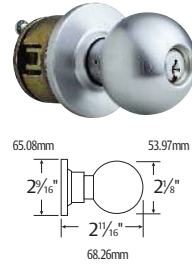

Ball BD
Knob: B Wrought
Rose: D Wrought

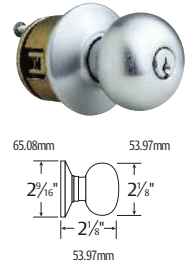

Tudor TA
Knob: T Wrought
Rose: A Wrought

Plate Trim:

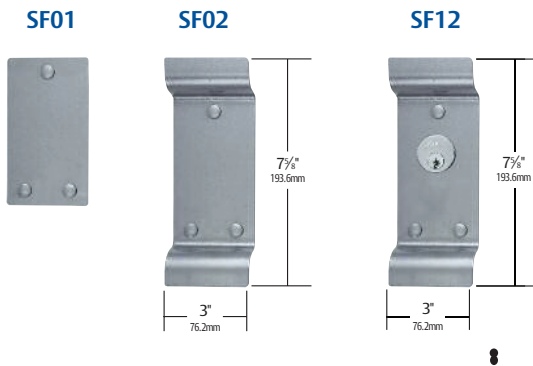

Lever Trim Cover Plate:

38-88A

- For use when retrofitting new style chassis or old style.
- Specify finish
- Order with new style exit device



*SF12 for S1250/FS1250 only.

The ASSA ABLOY Group is the global leader in access solutions. Every day, we help billions of people experience a more open world.

ASSA ABLOY Opening Solutions leads the development within door openings and products for access solutions in homes, businesses and institutions. Our offering includes doors, frames, door and window hardware, mechanical and smart locks, access control and service.



ASSA ABLOY

Arrow Lock & Door Hardware
225 Episcopal Road
Berlin, CT 06037
Customer Service: 1-800-327-8539
Technical Product Support: 1-800-327-8539 X2
www.arrowlock.com

Experience a safer
and more open world



Arrow Express 

TABLE OF CONTENTS

Cylindrical Locks.....	3-10
Cylindrical Indicator Lock.....	11
Cylindrical Knob.....	12-14
Deadbolts.....	15-17
Exit Devices and Lever Trim.....	18
Door Control.....	19-21
Cylinders.....	22-23

TERMS AND CONDITIONS OF SALE

Prices

Refer to the Arrow Lock Price Book in effect at the time the purchase order is submitted. Standard buying program discount applies.

Orders

Arrow Express part numbers must be included on the purchase order. Any orders received with items that are not currently in the Arrow Express program will be shipped at standard factory lead times.

Minimum Order

Minimum invoice is \$500 net product value.

Changes/Cancellations

Due to the promptness of delivery, no changes or cancellations can be accepted. The only exception is when we are out of stock.

Quotes

When applicable, a valid quote number must be included with the purchase order. Orders without this information will be processed at standard buying program discount.

Lead Time

Lead time is 5 business days from receipt of order. We reserve the right to limit quantities.

Freight

All orders are shipped F.O.B. factory. When accepted by the carrier, the purchaser assumes the risk of loss or damage in transit. Unless otherwise noted, orders will be shipped by Arrow's carrier of choice. Freight and handling charges are prepaid and added to the customer's invoice. Customer orders with net product value in excess of \$2,000 will be shipped prepaid by Arrow's carrier of choice to a single destination within the continental United States.

GRADE 1 CYLINDRICAL LEVER LOCK

QL Series



ASSA ABLOY

Experience a safer
and more open world



Functions Freewheeling, 2-3/4" Backset	
Passage, Bright Brass	XQL01-SR-605
Passage, Satin Chrome	XQL01-SR-626
Passage, Dark Oxidized Satin Bronze Equivalent	XQL01-SR-613E
Privacy, Bright Brass	XQL72-SR-605
Privacy, Satin Chrome	XQL72-SR-613E
Privacy, Dark Oxidized Satin Bronze Equivalent	XQL72-SR-626
Entrance, Bright Brass, AR Keyway	XQL81-SR-605-ARKD
Entrance, Bright Brass, CS Keyway	XQL81-SR-605-CSKD
Entrance, Bright Brass, SFIC Prep	XQL81-SR-605-IC
Entrance, Satin Chrome, AR Keyway	XQL81-SR-626-ARKD
Entrance, Satin Chrome, CS Keyway	XQL81-SR-626-CSKD
Entrance, Satin Chrome, SFIC Prep	XQL81-SR-626-IC
Entrance, Satin Chrome, LFIC Prep for Medeco 320201 or ASSA	XQL81-SR-626-LIC
Entrance, Satin Chrome, LFIC Prep for Schlage	XQL81-SR-626-SIC
Entrance, Dark Oxidized Satin Bronze Equivalent, AR Keyway	XQL81-SR-613E-ARKD
Entrance, Dark Oxidized Satin Bronze Equivalent, CS Keyway	XQL81-SR-613E-CSKD
Entrance, Dark Oxidized Satin Bronze Equivalent, SFIC Prep	XQL81-SR-613E-IC
Entrance, Dark Oxidized Satin Bronze Equivalent, LFIC Prep for Medeco 320201 or ASSA	XQL81-SR-613E-LIC
Storeroom, Bright Brass, AR Keyway	XQL82-SR-605-ARKD
Storeroom, Bright Brass, CS Keyway	XQL82-SR-605-CSKD
Storeroom, Bright Brass, SFIC Prep	XQL82-SR-605-IC
Storeroom, Satin Chrome, AR Keyway	XQL82-SR-626-ARKD
Storeroom, Satin Chrome, CS Keyway	XQL82-SR-626-CSKD
Storeroom, Satin Chrome, SFIC Prep	XQL82-SR-626-IC
Storeroom, Satin Chrome, LFIC Prep for Medeco 320201 or ASSA	XQL82-SR-626-LIC
Storeroom, Satin Chrome, LFIC Prep for Schlage	XQL82-SR-626-SIC
Storeroom, Dark Oxidized Satin Bronze Equivalent, AR Keyway	XQL82-SR-613E-ARKD
Storeroom, Dark Oxidized Satin Bronze Equivalent, CS Keyway	XQL82-SR-613E-CSKD
Storeroom, Dark Oxidized Satin Bronze Equivalent, SFIC Prep	XQL82-SR-613E-IC
Storeroom, Dark Oxidized Satin Bronze Equivalent, LFIC Prep for Medeco 320201 or ASSA	XQL82-SR-613E-LIC
Classroom, Bright Brass, AR Keyway	XQL87-SR-605-ARKD
Classroom, Bright Brass, CS Keyway	XQL87-SR-605-CSKD
Classroom, Bright Brass, SFIC Prep	XQL87-SR-605-IC
Classroom, Satin Chrome, AR Keyway	XQL87-SR-626-ARKD
Classroom, Satin Chrome, CS Keyway	XQL87-SR-626-CSKD
Classroom, Satin Chrome, SFIC Prep	XQL87-SR-626-IC
Classroom, Satin Chrome, LFIC Prep for Medeco 320201 or ASSA	XQL87-SR-626-LIC
Classroom, Satin Chrome, LFIC Prep for Schlage	XQL87-SR-626-SIC
Classroom, Dark Oxidized Satin Bronze Equivalent, AR Keyway	XQL87-SR-613E-ARKD
Classroom, Dark Oxidized Satin Bronze Equivalent, CS Keyway	XQL87-SR-613E-CSKD
Classroom, Dark Oxidized Satin Bronze Equivalent, SFIC Prep	XQL87-SR-613E-IC
Classroom, Dark Oxidized Satin Bronze Equivalent, LFIC Prep for Medeco 320201 or ASSA	XQL87-SR-613E-LIC
Classroom Intruder, Satin Chrome, AR Keyway	XQL97-SR-626-ARKD
Classroom Intruder, Satin Chrome, CS Keyway	XQL97-SR-626-CSKD
Classroom Intruder, Satin Chrome, SFIC Prep	XQL97-SR-626-IC

GRADE 1 CYLINDRICAL LEVER LOCK

QL Series



ASSA ABLOY

Experience a safer
and more open world



Functions Freewheeling, 2-3/4" Backset	
Classroom Intruder, Satin Chrome, LFIC Prep for Medeco 320201 or ASSA	XQL97-SR-626-LIC
Classroom Intruder, Satin Bronze, AR Keyway	XQL97-SR-613E-ARKD
Classroom Intruder, Satin Bronze, CS Keyway	XQL97-SR-613E-CSKD
Classroom Intruder, Satin Bronze, SFIC Prep	XQL97-SR-613E-IC
Asylum, Satin Chrome, AR Keyway	XQL93-SR-626-ARKD
Asylum, Satin Chrome, CS Keyway	XQL93-SR-626-CSKD
Asylum, Satin Chrome, SFIC Prep	XQL93-SR-626-IC
Asylum, Satin Chrome, LFIC Prep for Medeco 320201 or ASSA	XQL93-SR-626-LIC
Asylum (rigid lever), Satin Chrome, AR Keyway	XQL33-SR-626-ARKD
Asylum (rigid lever), Satin Chrome, CS Keyway	XQL33-SR-626-CSKD
Asylum (rigid lever), Satin Chrome, SFIC Prep	XQL33-SR-626-IC

Parts	
Standard Cylinder - Screw Cap - AR Keyway, Satin Brass	X-C700HD.606
Standard Cylinder - Screw Cap - AR Keyway, Satin Chrome	X-C700HD.626
Standard Cylinder - Screw Cap - CS Keyway, Satin Brass	X-C700HD-CS.606
Standard Cylinder - Screw Cap - CS Keyway, Satin Chrome	X-C700HD-CS.626
Tailpiece for Screw Cap Cylinder	X-1001SC-44.FIN
Screw Cap for Screw Cap Cylinder	X-SC-01.FIN
Screw Cap Pin for Screw Cap Cylinder	X-SC-02.FIN
Screw Cap Spring for Screw Cap Cylinder	X-SC-03.FIN
Housing Cap For Standard Cylinder	X-700HD-111PK.FIN
Tailpiece Kit For IC Lock Prep	X-RLX-44-201.FIN
Tailpiece For LIC Lock Prep	X-QL-44.FIN
Tailpiece Retainer For LIC Lock Prep	X-QL-66.FIN
Tailpiece For SIC Lock Prep	X-QL-44S.FIN
Standard Locking Latch, 2-3/4" Backset, Bright Brass	X-Q71.03
Standard Locking Latch, 2-3/4" Backset, Satin Stainless Steel	X-Q71.32D
Standard Locking Latch, 2-3/4" Backset, Dark Oxidized Satin Bronze Equivalent	X-Q71.613E
Standard Non-Locking Latch, 2-3/4" Backset, Bright Brass	X-Q73.03
Standard Non-Locking Latch, 2-3/4" Backset, Satin Stainless Steel	X-Q73.32D
Standard Non-Locking Latch, 2-3/4" Backset, Dark Oxidized Satin Bronze Equivalent	X-Q73.613E
Optional Locking Latch, 2-3/8" Backset, Bright Brass	ARX-R20.03
Optional Locking Latch, 2-3/8" Backset, Satin Stainless Steel	ARX-R20.32D
Optional Locking Latch, 2-3/8" Backset, Dark Oxidized Satin Bronze Equivalent	ARX-R20.613E
Optional Non-Locking Latch, 2-3/8" Backset, Bright Brass	ARX-R22.03
Optional Non-Locking Latch, 2-3/8" Backset, Satin Stainless Steel	ARX-R22.32D
Optional Non-Locking Latch, 2-3/8" Backset, Dark Oxidized Satin Bronze Equivalent	ARX-R22.613E
Latch and Strike Screw Pack, Bright Brass	X-RLX-201.605
Latch and Strike Screw Pack, Satin Chrome	X-RLX-201.626
Latch and Strike Screw Pack, Dark Oxidized Satin Bronze Equivalent	X-RLX-201.613E
SR Trim Screw Pack, Mounting Screws and Thru-bolt Posts	X-RLX-201A.FIN
Drill Jig	X-CYL-DRILL-JIG.FIN

GRADE 1 CYLINDRICAL LEVER LOCK

GL Series



ASSA ABLOY

Experience a safer
and more open world



Functions Freewheeling, 2-3/4" Backset

Passage, Satin Chrome	XGL01-SR-26D-306-G73
Privacy, Satin Chrome	XGL02-SR-26D-306-G73
Entrance, Satin Chrome, AR Keyway	XGL81-SR-26D-306-G71-ARKD
Entrance, Satin Chrome, CS Keyway	XGL81-SR-26D-306-G71-CSKD
Entrance, Satin Chrome, SFIC Prep	XGL81-SR-26D-306-G71-IC
Storeroom, Satin Chrome, AR Keyway	XGL82-SR-26D-306-G71-ARKD
Storeroom, Satin Chrome, CS Keyway	XGL82-SR-26D-306-G71-CSKD
Storeroom, Satin Chrome, SFIC Prep	XGL82-SR-26D-306-G71-IC
Classroom, Satin Chrome, AR Keyway	XGL87-SR-26D-306-G71-ARKD
Classroom, Satin Chrome, CS Keyway	XGL87-SR-26D-306-G71-CSKD
Classroom, Satin Chrome, SFIC Prep	XGL87-SR-26D-306-G71-IC
Classroom Intruder, Satin Chrome, AR Keyway	XGL97-SR-26D-306-G71-ARKD
Classroom Intruder, Satin Chrome, CS Keyway	XGL97-SR-26D-306-G71-CSKD
Classroom Intruder, Satin Chrome, SFIC Prep	XGL97-SR-26D-306-G71-IC

Parts

Drill Jig	X-CYL-DRILL-JIG.FIN
-----------	---------------------

GRADE 1 CYLINDRICAL LEVER LOCK

HK Series



ASSA ABLOY

Experience a safer
and more open world

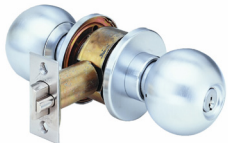

Functions 2-3/4" Backset	
Passage, Bright Brass	XHK01-BB-03-306-Q73
Passage, Dark Oxidized Satin Bronze Clear Coated	XHK01-BB-10BP-306-Q73
Passage, Satin Stainless Steel	XHK01-BB-32D-306-Q73
Privacy, Bright Brass	XHK02-BB-03-306-Q73
Privacy, Dark Oxidized Satin Bronze Clear Coated	XHK02-BB-10BP-306-Q73
Privacy, Satin Stainless Steel	XHK02-BB-32D-306-Q73
Single Dummy, Bright Brass	XHK08-BB-03
Single Dummy, Dark Oxidized Satin Bronze Clear Coated	XHK08-BB-10BP
Single Dummy, Satin Stainless Steel	XHK08-BB-32D
Entrance, Bright Brass, AR Keyway	XHK11-BB-03-306-Q71-ARKD
Entrance, Bright Brass, CS Keyway	XHK11-BB-03-306-Q71-CSKD
Entrance, Bright Brass, SFIC Prep	XHK11-BB-03-306-Q71-IC
Entrance, Dark Oxidized Satin Bronze Clear Coated, AR Keyway	XHK11-BB10BP-306-Q71-ARKD
Entrance, Dark Oxidized Satin Bronze Clear Coated, CS Keyway	XHK11-BB10BP-306-Q71-CSKD
Entrance, Dark Oxidized Satin Bronze Clear Coated, SFIC Prep	XHK11-BB-10BP-306-Q71-IC
Entrance, Satin Stainless Steel, AR Keyway	XHK11-BB-32D-306-Q71-ARKD
Entrance, Satin Stainless Steel, CS Keyway	XHK11-BB-32D-306-Q71-CSKD
Entrance, Satin Stainless Steel, SFIC Prep	XHK11-BB-32D-306-Q71-IC
Storeroom, Bright Brass, AR Keyway	XHK12-BB-03-306-Q71-ARKD
Storeroom, Bright Brass, CS Keyway	XHK12-BB-03-306-Q71-CSKD
Storeroom, Bright Brass, SFIC Prep	XHK12-BB-03-306-Q71-IC
Storeroom, Dark Oxidized Satin Bronze Clear Coated, AR Keyway	XHK12-BB10BP-306-Q71-ARKD
Storeroom, Dark Oxidized Satin Bronze Clear Coated, CS Keyway	XHK12-BB10BP-306-Q71-CSKD
Storeroom, Dark Oxidized Satin Bronze Clear Coated, SFIC Prep	XHK12-BB-10BP-306-Q71-IC
Storeroom, Satin Stainless Steel, AR Keyway	XHK12-BB-32D-306-Q71-ARKD
Storeroom, Satin Stainless Steel, CS Keyway	XHK12-BB-32D-306-Q71-CSKD
Storeroom, Satin Stainless Steel, SFIC Prep	XHK12-BB-32D-306-Q71-IC
Classroom, Bright Brass, AR Keyway	XHK17-BB-03-306-Q71-ARKD
Classroom, Bright Brass, CS Keyway	XHK17-BB-03-306-Q71-CSKD
Classroom, Bright Brass, SFIC Prep	XHK17-BB-03-306-Q71-IC
Classroom, Dark Oxidized Satin Bronze Clear Coated, AR Keyway	XHK17-BB10BP-306-Q71-ARKD
Classroom, Dark Oxidized Satin Bronze Clear Coated, CS Keyway	XHK17-BB10BP-306-Q71-CSKD
Classroom, Dark Oxidized Satin Bronze Clear Coated, SFIC Prep	XHK17-BB-10BP-306-Q71-IC
Classroom, Satin Stainless Steel, AR Keyway	XHK17-BB-32D-306-Q71-ARKD
Classroom, Satin Stainless Steel, CS Keyway	XHK17-BB-32D-306-Q71-CSKD
Classroom, Satin Stainless Steel, SFIC Prep	XHK17-BB-32D-306-Q71-IC
Asylum, Satin Stainless Steel, AR Keyway	XHK33-BB-32D-306-Q71-ARKD
Asylum, Satin Stainless Steel, CS Keyway	XHK33-BB-32D-306-Q71-CSKD
Asylum, Satin Stainless Steel, SFIC Prep	XHK33-BB-32D-306-Q71-IC

GRADE 1 CYLINDRICAL LEVER LOCK

HK Series



ASSA ABLOY

Experience a safer
and more open world

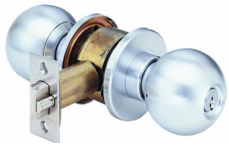

Parts	
Standard Cylinder, AR Keyway, Satin Brass	X-700HD.04
Standard Cylinder, AR Keyway, Satin Chrome	X-700HD.26D
Standard Cylinder, CS Keyway, Satin Brass	X-700HD-CS.04
Standard Cylinder, CS Keyway, Satin Chrome	X-700HD-CS.26D
Snap Ring For Standard Cylinder	X-700HD-103.FIN
Housing Cap For Standard Cylinder	X-700HD-111PK.FIN
Tailpiece For Standard Cylinder	X-700HD-44.FIN
Standard Locking Latch, 2-3/4" Backset, Bright Brass	X-Q71.03
Standard Locking Latch, 2-3/4" Backset, Satin Stainless Steel	X-Q71.32D
Standard Locking Latch, 2-3/4" Backset, Dark Oxidized Satin Bronze Equivalent	X-Q71.613E
Standard Non-Locking Latch, 2-3/4" Backset, Bright Brass	X-Q73.03
Standard Non-Locking Latch, 2-3/4" Backset, Satin Stainless Steel	X-Q73.32D
Standard Non-Locking Latch, 2-3/4" Backset, Dark Oxidized Satin Bronze Equivalent	X-Q73.613E
Optional Locking Latch, 2-3/8" Backset, Bright Brass	ARX-R20.03
Optional Locking Latch, 2-3/8" Backset, Satin Stainless Steel	ARX-R20.32D
Optional Locking Latch, 2-3/8" Backset, Dark Oxidized Satin Bronze Equivalent	ARX-R20.613E
Optional Non-Locking Latch, 2-3/8" Backset, Bright Brass	ARX-R22.03
Optional Non-Locking Latch, 2-3/8" Backset, Satin Stainless Steel	ARX-R22.32D
Optional Non-Locking Latch, 2-3/8" Backset, Dark Oxidized Satin Bronze Equivalent	ARX-R22.613E
Screw Pacl, Bright Brass	X-HK-201.605
Screw Pacl, Dark Oxidized Satin Bronze Equivalent	X-HK-201.613E
Screw Pacl, Satin Stainless Steel	X-HK-201.630
Tailpiece Kit for HK IC Lock Prep	X-HK-44-201.FIN

GRADE 2 CYLINDRICAL LEVER LOCK

MLX Series



ASSA ABLOY

Experience a safer
and more open world



Functions Freewheeling, 2-3/4" Backset	
Passage, Bright Brass	XMLX01-SR-605-R23
Passage, Satin Chrome	XMLX01-SR-626-R23
Passage, Dark Oxidized Satin Bronze Equivalent	XMLX01-SR-613E-R23
Single Dummy, Bright Brass	XMLX08-SR-605
Single Dummy, Satin Chrome	XMLX08-SR-626
Single Dummy, Dark Oxidized Satin Bronze Equivalent	XMLX08-SR-613E
Privacy, Bright Brass	XMLX72-SR-605-R23
Privacy, Satin Chrome	XMLX72-SR-613E-R23
Privacy, Dark Oxidized Satin Bronze Equivalent	XMLX72-SR-626-R23
Entrance, Bright Brass, AR Keyway	XMLX81-SR-605-R21-ARKD
Entrance, Bright Brass, CS Keyway	XMLX81-SR-605-R21-CSKD
Entrance, Bright Brass, SFIC Prep	XMLX81-SR-605-R21-IC
Entrance, Satin Chrome, AR Keyway	XMLX81-SR-626-R21-ARKD
Entrance, Satin Chrome, CS Keyway	XMLX81-SR-626-R21-CSKD
Entrance, Satin Chrome, SFIC Prep	XMLX81-SR-626-R21-IC
Entrance, Satin Chrome, LFIC Prep for Schlage	XMLX81-SR-626-R21-SIC
Entrance, Dark Oxidized Satin Bronze Equivalent, AR Keyway	XMLX81-SR-613E-R21-ARKD
Entrance, Dark Oxidized Satin Bronze Equivalent, CS Keyway	XMLX81-SR-613E-R21-CSKD
Entrance, Dark Oxidized Satin Bronze Equivalent, SFIC Prep	XMLX81-SR-613E-R21-IC
Storeroom, Bright Brass, AR Keyway	XMLX82-SR-605-R21-ARKD
Storeroom, Bright Brass, CS Keyway	XMLX82-SR-605-R21-CSKD
Storeroom, Bright Brass, SFIC Prep	XMLX82-SR-605-R21-IC
Storeroom, Satin Chrome, AR Keyway	XMLX82-SR-626-R21-ARKD
Storeroom, Satin Chrome, CS Keyway	XMLX82-SR-626-R21-CSKD
Storeroom, Satin Chrome, SFIC Prep	XMLX82-SR-626-R21-IC
Storeroom, Satin Chrome, LFIC Prep for Schlage	XMLX82-SR-626-R21-SIC
Storeroom, Dark Oxidized Satin Bronze Equivalent, AR Keyway	XMLX82-SR-613E-R21-ARKD
Storeroom, Dark Oxidized Satin Bronze Equivalent, CS Keyway	XMLX82-SR-613E-R21-CSKD
Storeroom, Dark Oxidized Satin Bronze Equivalent, SFIC Prep	XMLX82-SR-613E-R21-IC
Classroom, Bright Brass, AR Keyway	XMLX87-SR-605-R21-ARKD
Classroom, Bright Brass, CS Keyway	XMLX87-SR-605-R21-CSKD
Classroom, Bright Brass, SFIC Prep	XMLX87-SR-605-R21-IC
Classroom, Satin Chrome, AR Keyway	XMLX87-SR-626-R21-ARKD
Classroom, Satin Chrome, CS Keyway	XMLX87-SR-626-R21-CSKD
Classroom, Satin Chrome, SFIC Prep	XMLX87-SR-626-R21-IC
Classroom, Dark Oxidized Satin Bronze Equivalent, AR Keyway	XMLX87-SR-613E-R21-ARKD
Classroom, Dark Oxidized Satin Bronze Equivalent, CS Keyway	XMLX87-SR-613E-R21-CSKD
Classroom, Dark Oxidized Satin Bronze Equivalent, SFIC Prep	XMLX87-SR-613E-R21-IC
Asylum, Satin Chrome, AR Keyway	XMLX93-SR-626-R21-ARKD
Asylum, Satin Chrome, CS Keyway	XMLX93-SR-626-R21-CSKD
Asylum, Satin Chrome, SFIC Prep	XMLX93-SR-626-R21-IC
Asylum (rigid lever), Satin Chrome, AR Keyway	XMLX33-SR-626-R21-ARKD
Asylum (rigid lever), Satin Chrome, CS Keyway	XMLX33-SR-626-R21-CSKD
Asylum (rigid lever), Satin Chrome, SFIC Prep	XMLX33-SR-626-R21-IC

GRADE 2 CYLINDRICAL LEVER LOCK

MLX Series



ASSA ABLOY

Experience a safer
and more open world



Parts	
Standard Cylinder - Screw Cap - AR Keyway, Satin Brass	X-C700HD.606
Standard Cylinder - Screw Cap - AR Keyway, Satin Chrome	X-C700HD.626
Standard Cylinder - Screw Cap - CS Keyway, Satin Brass	X-C700HD-CS.606
Standard Cylinder - Screw Cap - CS Keyway, Satin Chrome	X-C700HD-CS.626
Housing Cap For Standard Cylinder	X-700HD-111PK.FIN
Tailpiece for Screw Cap Cylinder	X-1001SC-44.FIN
Screw Cap for Screw Cap Cylinder	X-SC-01.FIN
Screw Cap PIN for Screw Cap Cylinder	X-SC-02.FIN
Screw Cap Spring for Screw Cap Cylinder	X-SC-03.FIN
Standard Locking Latch, 2-3/4" Backset, Bright Brass	ARX-R21.03
Standard Locking Latch, 2-3/4" Backset, Satin Stainless Steel	ARX-R21.32D
Standard Locking Latch, 2-3/4" Backset, Dark Oxidized Satin Bronze Equivalent	ARX-R21.613E
Standard Non-Locking Latch, 2-3/4" Backset, Bright Brass	ARX-R23.03
Standard Non-Locking Latch, 2-3/4" Backset, Satin Stainless Steel	ARX-R23.32D
Standard Non-Locking Latch, 2-3/4" Backset, Dark Oxidized Satin Bronze Equivalent	ARX-R23.613E
Optional Locking Latch, 2-3/8" Backset, Bright Brass	ARX-R20.03
Optional Locking Latch, 2-3/8" Backset, Satin Stainless Steel	ARX-R20.32D
Optional Locking Latch, 2-3/8" Backset, Dark Oxidized Satin Bronze Equivalent	ARX-R20.613E
Optional Non-Locking Latch, 2-3/8" Backset, Bright Brass	ARX-R22.03
Optional Non-Locking Latch, 2-3/8" Backset, Satin Stainless Steel	ARX-R22.32D
Optional Non-Locking Latch, 2-3/8" Backset, Dark Oxidized Satin Bronze Equivalent	ARX-R22.613E
Latch and Strike Screw Pack, Bright Brass	X-RLX-201.605
Latch and Strike Screw Pack, Satin Chrome	X-RLX-201.626
Latch and Strike Screw Pack, Dark Oxidized Satin Bronze Equivalent	X-RLX-201.613E
SR Trim Screw Pack, Mounting Screws and Thru-bolt Posts	X-RLX-201A.FIN
Tailpiece Kit For IC Lock Prep	X-RLX-44-201.FIN
Drill Jig	X-CYL-DRILL-JIG.FIN

GRADE 2 CYLINDRICAL LEVER LOCK

RL Series



ASSA ABLOY

Experience a safer
and more open world



Functions Rigid Lever, 2-3/4" Backset	
Passage, Satin Chrome	XRL01-SR-26D-R62-R73
Passage, Dark Oxidized Satin Bronze Equivalent	XRL01-SR-613E-R62-R73
Passage, Black Suede Powder Coated	XRL01-SR-BSP-R62-R73
Privacy, Satin Chrome	XRL02-SR-26D-R62-R73
Privacy, Dark Oxidized Satin Bronze Equivalent	XRL02-SR-613E-R62-R73
Privacy, Black Suede Powder Coated	XRL02-SR-BSP-R62-R73
Single Dummy, Dark Oxidized Satin Bronze Equivalent	XRL08-SR-613E
Single Dummy, Black Suede Powder Coated	XRL08-SR-BSP
Entrance, Satin Chrome, AR Keyway	XRL11-SR-26D-R62-R71-ARKD
Entrance, Satin Chrome, CS Keyway	XRL11-SR-26D-R62-R71-CSKD
Entrance, Satin Chrome, SFIC Prep	XRL11-SR-26D-R62-R71-IC
Entrance, Satin Chrome, Less Cylinder	XRL11-SR-26D-R62-R71-LC
Entrance, Dark Oxidized Satin Bronze Equivalent, AR Keyway	XRL11-SR613E-R62-R71-ARKD
Entrance, Dark Oxidized Satin Bronze Equivalent, CS Keyway	XRL11-SR613E-R62-R71-CSKD
Entrance, Dark Oxidized Satin Bronze Equivalent, SFIC Prep	XRL11-SR-613E-R62-R71-IC
Entrance, Black Suede Powder Coated, AR Keyway	XRL11-SR-BSP-R62-R71-ARKD
Entrance, Black Suede Powder Coated, CS Keyway	XRL11-SR-BSP-R62-R71-CSKD
Entrance, Black Suede Powder Coated, SFIC Prep	XRL11-SR-BSP-R62-R71-IC
Storeroom, Satin Chrome, AR Keyway	XRL12-SR-26D-R62-R71-ARKD
Storeroom, Satin Chrome, CS Keyway	XRL12-SR-26D-R62-R71-CSKD
Storeroom, Satin Chrome, SFIC Prep	XRL12-SR-26D-R62-R71-IC
Storeroom, Satin Chrome, Less Cylinder	XRL12-SR-26D-R62-R71-LC
Classroom, Satin Chrome, AR Keyway	XRL17-SR-26D-R62-R71-ARKD
Classroom, Satin Chrome, CS Keyway	XRL17-SR-26D-R62-R71-CSKD
Classroom, Satin Chrome, SFIC Prep	XRL17-SR-26D-R62-R71-IC
Classroom, Satin Chrome, Less Cylinder	XRL17-SR-26D-R62-R71-LC
Storeroom, Dark Oxidized Satin Bronze Equivalent, AR Keyway	XRL12-SR613E-R62-R71-ARKD
Storeroom, Dark Oxidized Satin Bronze Equivalent, CS Keyway	XRL12-SR613E-R62-R71-CSKD
Storeroom, Dark Oxidized Satin Bronze Equivalent, SFIC Prep	XRL12-SR-613E-R62-R71-IC
Storeroom, Black Suede Powder Coated, AR Keyway	XRL12-SR-BSP-R62-R71-ARKD
Storeroom, Black Suede Powder Coated, CS Keyway	XRL12-SR-BSP-R62-R71-CSKD
Storeroom, Black Suede Powder Coated, SFIC Prep	XRL12-SR-BSP-R62-R71-IC
Classroom, Dark Oxidized Satin Bronze Equivalent, AR Keyway	XRL17-SR613E-R62-R71-ARKD
Classroom, Dark Oxidized Satin Bronze Equivalent, CS Keyway	XRL17-SR613E-R62-R71-CSKD
Classroom, Dark Oxidized Satin Bronze Equivalent, SFIC Prep	XRL17-SR-613E-R62-R71-IC
Classroom, Black Suede Powder Coated, AR Keyway	XRL17-SR-BSP-R62-R71-ARKD
Classroom, Black Suede Powder Coated, CS Keyway	XRL17-SR-BSP-R62-R71-CSKD
Classroom, Black Suede Powder Coated, SFIC Prep	XRL17-SR-BSP-R62-R71-IC

GRADE 2 CYLINDRICAL LEVER LOCK

RL Series



ASSA ABLOY

Experience a safer
and more open world

Parts

Standard Locking Latch, 2-3/4" Backset, Bright Brass	X-R71.03
Standard Locking Latch, 2-3/4" Backset, Dark Oxidized Satin Bronze, Oil Rubbed	X-R71.10B
Standard Locking Latch, 2-3/4" Backset, Satin Stainless Steel	X-R71.32D
Standard Locking Latch, 2-3/4" Backset, Dark Oxidized Satin Bronze Equivalent	X-R71.613E
Standard Locking Latch, 2-3/4" Backset, Black Suede Powder Coated	X-R71.BSP
Standard Non-Locking Latch, 2-3/4" Backset, Bright Brass	X-R73.03
Standard Non-Locking Latch, 2-3/4" Backset, Dark Oxidized Satin Bronze, Oil Rubbed	X-R73.10B
Standard Non-Locking Latch, 2-3/4" Backset, Satin Stainless Steel	X-R73.32D
Standard Non-Locking Latch, 2-3/4" Backset, Dark Oxidized Satin Bronze Equivalent	X-R73.613E
Standard Non-Locking Latch, 2-3/4" Backset, Black Suede Powder Coated	X-R73.BSP
Optional Locking Latch, 2-3/8" Backset, Bright Brass	X-R70.03
Optional Locking Latch, 2-3/8" Backset, Dark Oxidized Satin Bronze, Oil Rubbed	X-R70.10B
Optional Locking Latch, 2-3/8" Backset, Satin Stainless Steel	X-R70.32D
Optional Locking Latch, 2-3/8" Backset, Dark Oxidized Satin Bronze Equivalent	X-R70.613E
Optional Locking Latch, 2-3/8" Backset, Black Suede Powder Coated	X-R70.BSP
Optional Non-Locking Latch, 2-3/8" Backset, Bright Brass	X-R72.03
Optional Non-Locking Latch, 2-3/8" Backset, Dark Oxidized Satin Bronze, Oil Rubbed	X-R72.10B
Optional Non-Locking Latch, 2-3/8" Backset, Satin Stainless Steel	X-R72.32D
Optional Non-Locking Latch, 2-3/8" Backset, Dark Oxidized Satin Bronze Equivalent	X-R72.613E
Optional Non-Locking Latch, 2-3/8" Backset, Black Suede Powder Coated	X-R72.BSP
RL Screw Pack (No Thru Posts)	X-RL-201.605
RL Screw Pack (No Thru Posts)	X-RL-201.626
RL Screw Pack (No Thru Posts)	X-RL-201.613E
RL Thru Bolt Posts Pack	X-RL-201A.FIN

GRADE 1 CYLINDRICAL INDICATOR LEVER LOCK

APL Series



ASSA ABLOY

Experience a safer
and more open world

Functions Freewheeling, 2-3/4" Backset

Privacy Indicator, Satin Chrome, 2-3/4" Backset

XAPL02-ST-626-Q73

Parts

Thin Door Spacer Kit	X-138-SPACER-KIT.FIN
Standard Non-Locking Latch, 2-3/4" Backset, Bright Brass	X-Q73.03
Standard Non-Locking Latch, 2-3/4" Backset, Satin Stainless Steel	X-Q73.32D
Standard Non-Locking Latch, 2-3/4" Backset, Dark Oxidized Satin Bronze Equivalent	X-Q73.613E
Standard Non-Locking Latch, 2-3/4" Backset, Black Suede Powder Coated	X-Q73.BSP
Optional Locking Latch, 2-3/8" Backset, Bright Brass	ARX-R20.03
Optional Locking Latch, 2-3/8" Backset, Satin Stainless Steel	ARX-R20.32D
Optional Locking Latch, 2-3/8" Backset, Dark Oxidized Satin Bronze Equivalent	ARX-R20.613E
Optional Locking Latch, 2-3/8" Backset, Black Suede Powder Coated	ARX-R20.BSP
Screw Pack, Bright Brass	X-QL-201.03
Screw Pack, Satin Chrome	X-QL-201.26D
Screw Pack, Dark Oxidized Satin Bronze Equivalent	X-QL-201.613E
Screw Pack, Black Suede Powder Coated	X-QL-201.BSP
Drill Jig	X-CYL-DRILL-JIG.FIN

GRADE 2 CYLINDRICAL KNOB LOCK

MK Series



ASSA ABLOY

Experience a safer
and more open world



Functions	
Passage, BD Trim, Satin Chrome, 2-3/8" Backset	XMK01-BD-26D-300-101
Passage, BD Trim, Satin Chrome, 2-3/4" Backset	XMK01-BD-26D-300-104
Passage, TA Trim, Satin Chrome, 2-3/4" Backset	XMK01-TA-26D-300-104
Privacy, BD Trim, Satin Chrome, 2-3/8" Backset	XMK02-BD-26D-300-101
Privacy, BD Trim, Satin Chrome, 2-3/4" Backset	XMK02-BD-26D-300-104
Entrance, BD Trim, Satin Chrome, 2-3/8" Backset, AR Keyway	XMK11-BD26D-300-111-ARKA4
Entrance, BD Trim, Satin Chrome, 2-3/8" Backset, CS Keyway	XMK11-BD26D-300-111-CSKA4
Entrance, BD Trim, Satin Chrome, 2-3/4" Backset, AR Keyway	XMK11-BD26D-300-114-ARKA4
Entrance, BD Trim, Satin Chrome, 2-3/4" Backset, CS Keyway	XMK11-BD26D-300-114-CSKA4
Entrance, TA Trim, Bright Brass, 2-3/8" Backset, AR Keyway	XMK11-TA-03-300-111-ARKA4
Entrance, TA Trim, Bright Brass, 2-3/8" Backset, CS Keyway	XMK11-TA-03-300-111-CSKA4
Entrance, TA Trim, Bright Brass, 2-3/4" Backset, AR Keyway	XMK11-TA-03-300-114-ARKA4
Entrance, TA Trim, Satin Chrome, 2-3/4" Backset, AR Keyway	XMK11-TA26D-300-114-ARKA4
Entrance, TA Trim, Satin Chrome, 2-3/4" Backset, CS Keyway	XMK11-TA26D-300-114-CSKA4
Entrance, TA Trim, Satin Chrome, 2-3/4" Backset, SFIC Prep	XML11-TA-626-300-124-IC
Storeroom, BD Trim, Satin Chrome, 2-3/8" Backset, AR Keyway 4	XMK12-BD26D-300-111-ARKA
Storeroom, BD Trim, Satin Chrome, 2-3/8" Backset, CS Keyway	XMK12-BD26D-300-111-CSKA4
Storeroom, BD Trim, Satin Chrome, 2-3/4" Backset, AR Keyway	XMK12-BD26D-300-114-ARKA4
Storeroom, BD Trim, Satin Chrome, 2-3/4" Backset, CS Keyway	XMK12-BD26D-300-114-CSKA4
Storeroom, TA Trim, Satin Chrome, 2-3/4" Backset, AR Keyway	XMK12-TA26D-300-114-ARKA4
Storeroom, TA Trim, Satin Chrome, 2-3/4" Backset, CS Keyway	XMK12-TA26D-300-114-CSKA4
Storeroom, TA Trim, Satin Chrome, 2-3/4" Backset, SFIC Prep	XML12-TA-626-300-124-IC
Parts	
Dead Latch 2-3/8 BS (Non-UL)	X-111.32D

GRADE 2 CYLINDRICAL KNOB LOCK

RK Series



ASSA ABLOY

Experience a safer
and more open world



Functions	
Passage, 2-3/8" Backset, Bright Brass	XRK01-BD-03-R60-R72
Passage, 2-3/8" Backset, Stainless Steel	XRK01-BD-32D-R60-R72
Passage, 2-3/4" Backset, Stainless Steel	XRK01-BD-32D-R60-R73
Passage, 2-3/8" Backset, Dark Oxidized Satin Bronze Equivalent	XRK01-BD-613E-R60-R72
Passage, 2-3/8" Backset, Dark Oxidized Satin Bronze Equivalent	XRK01-BD-613E-R62-R72
Passage, 2-3/4" Backset, Dark Oxidized Satin Bronze Equivalent	XRK01-BD-613E-R62-R73
Passage, 2-3/8" Backset, Black Suede Powder Coated	XRK01-BD-BSP-R60-R72
Privacy, 2-3/8" Backset, Stainless Steel	XRK02-BD-32D-R60-R72
Privacy, 2-3/4" Backset, Stainless Steel	XRK02-BD-32D-R60-R73
Privacy, 2-3/8" Backset, Dark Oxidized Satin Bronze Equivalent	XRK02-BD-613E-R62-R72
Privacy, 2-3/8" Backset, Dark Oxidized Satin Bronze Equivalent	XRK02-BD-613E-R60-R72
Privacy, 2-3/8" Backset, Black Suede Powder Coated	XRK02-BD-BSP-R60-R72
Single Dummy, Dark Oxidized Satin Bronze Equivalent	XRK08-BD-613E
Single Dummy, Black Suede Powder Coated	XRK08-BD-BSP
Entrance, 2-3/8" Backset, Bright Brass, AR Keyway	XRK11-BD-03-R60-R70-ARKD
Entrance, 2-3/8" Backset, Bright Brass, CS Keyway	XRK11-BD-03-R60-R70-CSKD
Entrance, 2-3/8" Backset, Stainless Steel, AR Keyway	XRK11-BD-32D-R60-R70-ARKD
Entrance, 2-3/8" Backset, Stainless Steel, CS Keyway	XRK11-BD-32D-R60-R70-CSKD
Entrance, 2-3/8" Backset, Stainless Steel, SFIC Prep	XRK11-BD-32D-R60-R70-IC
Entrance, 2-3/8" Backset, Stainless Steel, Less Cylinder	XRK11-BD-32D-R60-R70-LC
Entrance, 2-3/4" Backset, Stainless Steel, AR Keyway	XRK11-BD-32D-R60-R71-ARKD
Entrance, 2-3/4" Backset, Stainless Steel, CS Keyway	XRK11-BD-32D-R60-R71-CSKD
Entrance, 2-3/4" Backset, Stainless Steel, SFIC Prep	XRK11-BD-32D-R60-R71-IC
Entrance, 2-3/4" Backset, Stainless Steel, Less Cylinder	XRK11-BD-32D-R60-R71-LC
Entrance, 2-3/8" Backset, Stainless Steel, CS Keyway	XRK11-BD-32D-R62-R70-CSKD
Entrance, 2-3/8" Backset, Stainless Steel, SFIC Prep	XRK11-BD-32D-R62-R70-IC
Entrance, 2-3/4" Backset, Stainless Steel, CS Keyway	XRK11-BD-32D-R62-R71-CSKD
Entrance, 2-3/4" Backset, Stainless Steel, SFIC Prep	XRK11-BD-32D-R62-R71-IC
Entrance, 2-3/8" Backset, Dark Oxidized Satin Bronze Equivalent, CS Keyway	XRK11-BD613E-R60-R70-CSKD
Entrance, 2-3/8" Backset, Dark Oxidized Satin Bronze Equivalent, SFIC Prep	XRK11-BD-613E-R60-R70-IC
Entrance, 2-3/8" Backset, Dark Oxidized Satin Bronze Equivalent, CS Keyway	XRK11-BD613E-R62-R70-CSKD
Entrance, 2-3/4" Backset, Dark Oxidized Satin Bronze Equivalent, CS Keyway	XRK11-BD613E-R62-R71-CSKD
Entrance, 2-3/4" Backset, Dark Oxidized Satin Bronze Equivalent, SFIC Prep	XRK11-BD-613E-R62-R71-IC
Entrance, 2-3/8" Backset, Dark Oxidized Satin Bronze Equivalent, AR Keyway	XRK11-BD613E-R60-R70-ARKD
Entrance, 2-3/8" Backset, Black Suede Powder Coated, AR Keyway	XRK11-BD-BSP-R60-R70-ARKD
Entrance, 2-3/8" Backset, Black Suede Powder Coated, CS Keyway	XRK11-BD-BSP-R60-R70-CSKD
Entrance, 2-3/4" Backset, Black Suede Powder Coated, SFIC Prep	XRK11-BD-BSP-R60-R70-IC
Storeroom, 2-3/8" Backset, Bright Brass, CS Keyway	XRK12-BD-03-R60-R70-CSKD
Storeroom, 2-3/8" Backset, Stainless Steel, AR Keyway	XRK12-BD-32D-R60-R70-ARKD
Storeroom, 2-3/8" Backset, Stainless Steel, CS Keyway	XRK12-BD-32D-R60-R70-CSKD
Storeroom, 2-3/8" Backset, Stainless Steel, SFIC Prep	XRK12-BD-32D-R60-R70-IC
Storeroom, 2-3/8" Backset, Stainless Steel, Less Cylinder	XRK12-BD-32D-R60-R70-LC
Storeroom, 2-3/4" Backset, Stainless Steel, AR Keyway	XRK12-BD-32D-R60-R71-ARKD
Storeroom, 2-3/4" Backset, Stainless Steel, CS Keyway	XRK12-BD-32D-R60-R71-CSKD

GRADE 2 CYLINDRICAL KNOB LOCK

RK Series



ASSA ABLOY

Experience a safer
and more open world



Functions	
Storeroom, 2-3/4" Backset, Stainless Steel, SFIC Prep	XRK12-BD-32D-R60-R71-IC
Storeroom, 2-3/4" Backset, Stainless Steel, Less Cylinder	XRK12-BD-32D-R60-R71-LC
Storeroom, 2-3/8" Backset, Stainless Steel, CS Keyway	XRK12-BD-32D-R62-R70-CSKD
Storeroom, 2-3/4" Backset, Stainless Steel, CS Keyway	XRK12-BD-32D-R62-R71-CSKD
Storeroom, 2-3/8" Backset, Dark Oxidized Satin Bronze Equivalent, CS Keyway	XRK12-BD613E-R60-R70-CSKD
Storeroom, 2-3/8" Backset, Dark Oxidized Satin Bronze Equivalent, CS Keyway	XRK12-BD613E-R62-R70-CSKD
Storeroom, 2-3/4" Backset, Dark Oxidized Satin Bronze Equivalent, CS Keyway	XRK12-BD613E-R62-R71-CSKD
Storeroom, 2-3/8" Backset, Dark Oxidized Satin Bronze Equivalent, SFIC Prep	XRK12-BD-613E-R60-R70-IC
Storeroom, 2-3/4" Backset, Dark Oxidized Satin Bronze Equivalent, SFIC Prep	XRK12-BD-613E-R62-R71-IC
Storeroom, 2-3/8" Backset, Dark Oxidized Satin Bronze Equivalent, AR Keyway	XRK12-BD613E-R60-R70-ARKD
Storeroom, 2-3/8" Backset, Black Suede Powder Coated, AR Keyway	XRK12-BD-BSP-R60-R70-ARKD
Storeroom, 2-3/8" Backset, Black Suede Powder Coated, CS Keyway	XRK12-BD-BSP-R60-R70-CSKD
Storeroom, 2-3/8" Backset, Black Suede Powder Coated, SFIC Prep	XRK12-BD-BSP-R60-R70-IC
Classroom, 2-3/8" Backset, Dark Oxidized Satin Bronze Equivalent, AR Keyway	XRK17-BD613E-R60-R70-ARKD
Classroom, 2 3/8" Backset, Dark Oxidized Satin Bronze Equivalent, CS Keyway	XRK17-BD613E-R60-R70-CSKD
Classroom, 2-3/8" Backset, Dark Oxidized Satin Bronze Equivalent, SFIC Prep	XRK17-BD-613E-R60-R70-IC
Classroom, 2-3/8" Backset, Black Suede Powder Coated, AR Keyway	XRK17-BD-BSP-R60-R70-ARKD
Classroom, 2-3/8" Backset, Black Suede Powder Coated, CS Keyway	XRK17-BD-BSP-R60-R70-CSKD
Classroom, 2-3/8" Backset, Black Suede Powder Coated, SFIC Prep	XRK17-BD-BSP-R60-R70-IC

Parts	
Standard Locking Latch, 2-3/8" Backset, Bright Brass	X-R70.03
Standard Locking Latch, 2-3/8" Backset, Dark Oxidized Satin Bronze, Oil Rubbed	X-R70.10B
Standard Locking Latch, 2-3/8" Backset, Satin Stainless Steel	X-R70.32D
Standard Locking Latch, 2-3/8" Backset, Dark Oxidized Satin Bronze Equivalent	X-R70.613E
Standard Locking Latch, 2-3/8" Backset, Black Suede Powder Coated	X-R70.BSP
Standard Non-Locking Latch, 2-3/8" Backset, Bright Brass	X-R72.03
Standard Non-Locking Latch, 2-3/8" Backset, Dark Oxidized Satin Bronze, Oil Rubbed	X-R72.10B
Standard Non-Locking Latch, 2-3/8" Backset, Satin Stainless Steel	X-R72.32D
Standard Non-Locking Latch, 2-3/8" Backset, Dark Oxidized Satin Bronze Equivalent	X-R72.613E
Standard Non-Locking Latch, 2-3/8" Backset, Black Suede Powder Coated	X-R72.BSP
Optional Locking Latch, 2-3/4" Backset, Bright Brass	X-R71.03
Optional Locking Latch, 2-3/4" Backset, Dark Oxidized Satin Bronze, Oil Rubbed	X-R71.10B
Optional Locking Latch, 2-3/4" Backset, Satin Stainless Steel	X-R71.32D
Optional Locking Latch, 2-3/4" Backset, Dark Oxidized Satin Bronze Equivalent	X-R71.613E
Optional Locking Latch, 2-3/4" Backset, Black Suede Powder Coated	X-R71.BSP
Optional Non-Locking Latch, 2-3/4" Backset, Bright Brass	X-R73.03
Optional Non-Locking Latch, 2-3/4" Backset, Dark Oxidized Satin Bronze, Oil Rubbed	X-R73.10B
Optional Non-Locking Latch, 2-3/4" Backset, Satin Stainless Steel	X-R73.32D
Optional Non-Locking Latch, 2-3/4" Backset, Dark Oxidized Satin Bronze Equivalent	X-R73.613E
Optional Non-Locking Latch, 2-3/4" Backset, Black Suede Powder Coated	X-R73.BSP
RK Screw Pack, Bright Brass	X-RK-201.605
RK Screw Pack, Satin Stainless Steel	X-RK-201.630
RK Screw Pack, Dark Oxidized Satin Bronze Equivalent	X-RK-201.613

GRADE 1 & 2 DEADBOLTS

D & E Series



ASSA ABLOY

Experience a safer
and more open world



Functions

Single Cylinder, Satin Chrome, 2-3/4" Backset, SFIC Prep	XD61-626-395-144-IC
Single Cylinder, Bright Brass, 2-3/8" Backset, AR Keyway	XE61-605-395-141-AR-KA4
Single Cylinder, Bright Brass, 2-3/8" Backset, CS Keyway	XE61-605-395-141-CS-KA4
Single Cylinder, Bright Brass, 2-3/4" Backset, AR Keyway	XE61-605-395-144-AR-KA4
Single Cylinder, Bright Brass, 2-3/4" Backset, CS Keyway	XE61-605-395-144-CS-KA4
Single Cylinder, Satin Chrome, 2-3/8" Backset, AR Keyway	XE61-626-395-141-AR-KA4
Single Cylinder, Satin Chrome, 2-3/8" Backset, CS Keyway	XE61-626-395-141-CS-KA4
Single Cylinder, Satin Chrome, 2-3/8" Backset, SFIC Prep	XE61-626-395-141-IC
Single Cylinder, Satin Chrome, 2-3/4" Backset, AR Keyway	XE61-626-395-144-AR-KA4
Single Cylinder, Satin Chrome, 2-3/4" Backset, CS Keyway	XE61-626-395-144-CS-KA4
Single Cylinder, Satin Chrome, 2-3/4" Backset, SFIC Prep	XE61-626-395-144-IC
Single Cylinder, Bright Brass, 2-3/8" Backset, SFIC Prep	XE61-605-395-141-IC
Single Cylinder, Bright Brass, 2-3/4" Backset, SFIC Prep	XE61-605-395-144-IC
Single Cylinder With Indicator, Satin Chrome, 2-3/8" Backset, CS Kw	XE61-626-395-141-V01-CSKD
Single Cylinder With Indicator, Satin Chrome, 2-3/4" Backset, CS Kw	XE61-626-395-144-V01-CSKD
Single Cylinder, Satin Chrome, 2-3/4" Backset Drive-in, AR Kw	XE61-626-395-146-AR-KA4
Double Cylinder, Bright Brass, 2-3/8" Backset, AR Keyway	XE62-605-395-141-AR-KA4
Double Cylinder, Bright Brass, 2-3/8" Backset, CS Keyway	XE62-605-395-141-CS-KA4
Double Cylinder, Bright Brass, 2-3/4" Backset, AR Keyway	XE62-605-395-144-AR-KA4
Double Cylinder, Bright Brass, 2-3/4" Backset, CS Keyway	XE62-605-395-144-CS-KA4
Double Cylinder, Satin Chrome, 2-3/8" Backset, AR Keyway	XE62-626-395-141-AR-KA4
Double Cylinder, Satin Chrome, 2-3/8" Backset, CS Keyway	XE62-626-395-141-CS-KA4
Double Cylinder, Satin Chrome, 2-3/4" Backset, AR Keyway	XE62-626-395-144-AR-KA4
Double Cylinder, Satin Chrome, 2-3/4" Backset, CS Keyway	XE62-626-395-144-CS-KA4
Occupancy Indicator, Satin Chrome, 2-3/8" Backset	XE50-626-395-141
Occupancy Indicator, Satin Chrome, 2-3/4" Backset	XE50-626-395-144
Occupancy Indicator, Black Suede Powder, 2-3/8" Backset	XE50-BSP-395-141
Occupancy Indicator, Black Suede Powder, 2-3/4" Backset	XE50-BSP-395-144
Occupancy Indicator, Satin Chrome, 2-3/8" & 2-3/4" Backset	XE50-626-395-149
Occupancy Indicator, Black Suede Powder, 2-3/8" & 2-3/4" Backset	XE50-BSP-395-149

Parts

Standard E Series Bolt, 2-3/8" Backset, Bright Brass	X-141.03
Standard E Series Bolt, 2-3/8" Backset, Satin Stainless Steel	X-141.32D
Standard D Series Bolt, 2-3/4" Backset, Satin Stainless Steel	X-144.32D
Optional Drive-In Bolt, 2-3/8" Backset, Satin Chrome	X-145.26D
Optional Drive-In Bolt, 2-3/4" Backset, Satin Chrome	X-146.26D

GRADE 2 DEADBOLTS

DBX Series



ASSA ABLOY

Experience a safer
and more open world

Functions 2-3/8" to 2-3/4" Adjustable Backset

Single Cylinder, Bright Brass, AR keyway	XDBX61-605-ARKA4
Single Cylinder, Bright Brass, CS keyway	XDBX61-605-CSKA4
Single Cylinder, Bright Brass, IC Prep	XDBX61-605-IC
Single Cylinder, Dark Oxidized Satin Bronze Equivalent, AR keyway	XDBX61-613E-ARKA4
Single Cylinder, Dark Oxidized Satin Bronze Equivalent, CS keyway	XDBX61-613E-CSKA4
Single Cylinder, Dark Oxidized Satin Bronze Equivalent, IC Prep	XDBX61-613E-IC
Single Cylinder, Satin Stainless Steel, AR keyway	XDBX61-630-ARKA4
Single Cylinder, Satin Stainless Steel, CS keyway	XDBX61-630-CSKA4
Single Cylinder, Satin Stainless Steel, IC Prep	XDBX61-630-IC
Single Cylinder, Black Painted, AR Keyway	XDBX61-693-ARKA4
Single Cylinder, Black Painted, CS Keyway	XDBX61-693-CSKA4
Single Cylinder, Black Painted, IC Prep	XDBX61-693-IC
Double Cylinder, Bright Brass, AR keyway	XDBX62-605-ARKA4
Double Cylinder, Bright Brass, CS keyway	XDBX62-605-CSKA4
Double Cylinder, Bright Brass, IC Prep	XDBX62-605-IC
Double Cylinder, Dark Oxidized Satin Bronze Equivalent, AR keyway	XDBX62-613E-ARKA4
Double Cylinder, Dark Oxidized Satin Bronze Equivalent, CS keyway	XDBX62-613E-CSKA4
Double Cylinder, Dark Oxidized Satin Bronze Equivalent, IC Prep	XDBX62-613E-IC
Double Cylinder, Satin Stainless Steel, AR keyway	XDBX62-630-ARKA4
Double Cylinder, Satin Stainless Steel, CS keyway	XDBX62-630-CSKA4
Double Cylinder, Satin Stainless Steel, IC Prep	XDBX62-630-IC
Double Cylinder, Black Painted, AR Keyway	XDBX62-693-ARKA4
Double Cylinder, Black Painted, CS Keyway	XDBX62-693-CSKA4
Double Cylinder, Black Painted, IC Prep	XDBX62-693-IC

GRADE 2 DEADBOLTS

DBX Series



ASSA ABLOY

Experience a safer
and more open world

Parts

Cylinder for DBX61, CS Keyway, Satin Brass	X-96C-CS-DBX.606
Cylinder for DBX61, CS Keyway, Satin Chrome	X-96C-CS-DBX.626
Cylinder for DBX61, AR Keyway, Satin Brass	X-96C-DBX.606
Cylinder for DBX61, AR Keyway, Satin Chrome	X-96C-DBX.626
Cylinder for DBX62, CS Keyway, Satin Brass	X-96DC-CS-DBX.606
Cylinder for DBX62, CS Keyway, Satin Chrome	X-96DC-CS-DBX.626
Cylinder for DBX62, AR Keyway, Satin Brass	X-96DC-DBX.606
Cylinder for DBX62, AR Keyway, Satin Chrome	X-96DC-DBX.626
Standard Strike, Bright Brass	X-DBX-394.605
Standard Strike, Dark Oxidized Satin Bronze Equivalent	X-DBX-394.613E
Standard Strike, Satin Stainless Steel	X-DBX-394.630
Standard Strike, Black Painted	X-DBX-394.693
Standard Bolt (adjustable), Bright Brass	X-DBX-L14.605
Standard Bolt (adjustable), Dark Oxidized Satin Bronze Equivalent	X-DBX-L14.613E
Standard Bolt (adjustable), Satin Stainless Steel	X-DBX-L14.630
Standard Bolt (adjustable), Black Painted	X-DBX-L14.693
Optional Drive-In Bolt (adjustable)	X-DBX-L18.FIN
Screw Pack For DBX61, Bright Brass	X-DBX61-201.605
Screw Pack For DBX61, Dark Oxidized Satin Bronze Equivalent	X-DBX61-201.613E
Screw Pack For DBX61, Satin Stainless Steel	X-DBX61-201.630
Screw Pack For DBX62, Bright Brass	X-DBX62-201.605
Screw Pack For DBX62, Dark Oxidized Satin Bronze Equivalent	X-DBX62-201.613E
Screw Pack For DBX62, Satin Stainless Steel	X-DBX62-201.630
Screw Pack for DBX61, Black Painted	X-DBX61-201.693
Screw Pack for DBX62, Black Painted	X-DBX62-201.693
Thick Door Pack (up to 2") For DBX61, Bright Brass	X-DBX61-TDP.605
Thick Door Pack (up to 2") For DBX61, Dark Oxidized Satin Bronze Equivalent	X-DBX61-TDP.613E
Thick Door Pack (up to 2") For DBX61, Satin Stainless Steel	X-DBX61-TDP.630
Thick Door Pack (up to 2") For DBX62, Bright Brass	X-DBX62-TDP.605
Thick Door Pack (up to 2") For DBX62, Dark Oxidized Satin Bronze Equivalent	X-DBX62-TDP.613E
Thick Door Pack (up to 2") For DBX62, Satin Stainless Steel	X-DBX62-TDP.630
Thick Door Pack (up to 2") for DBX61, Black Painted	X-DBX61-TDP.693
Thick Door Pack (up to 2") for DBX62, Black Painted	X-DBX62-TDP.693

EXIT DEVICE & LEVER TRIM

S1250, ED910, PEC910, SRX



ASSA ABLOY

Experience a safer
and more open world



Rim Exit Device	
S1250, Up To 36" Door Width, Silver Aluminum Painted	AXX-S1250.AL
S1250, Up To 48" Door Width, Silver Aluminum Painted	AXX-S1250-48.AL
Fire-Rated S1250, Up To 36" Door Width, Silver Aluminum Painted	AXX-FS1250.AL
ED910, Up To 36" Door Width, Satin Stainless Steel	X-ED910-36.32D
ED910, Up To 36" Door Width, Silver Aluminum Painted	X-ED910-36.AL
ED910, Up To 36" Door Width, Dark Oxidized Satin Bronze Equivalent	X-ED910-36.613E
ED910, Up To 48" Door Width, Satin Stainless Steel	X-ED910-48.32D
ED910, Up To 48" Door Width, Silver Aluminum Painted	X-ED910-48.AL
ED910, Up To 48" Door Width, Dark Oxidized Satin Bronze Equivalent	X-ED910-48.613E
PEC910, Up To 36" Door Width, Satin Stainless Steel	X-PEC910-36.32D
PEC910, Up To 36" Door Width, Silver Aluminum Painted	X-PEC910-36.AL
PEC910, Up To 36" Door Width, Dark Bronze Painted	X-PEC910-36.BRZ

Lever & Plate Trim	
Passage, Satin Chrome	XSRX01.26D
Passage, Dark Oxidized Satin Bronze Equivalent	XSRX01.613E
Storeroom, AR Keyway, Satin Chrome	XSRX82-AR-KD.26D
Storeroom, AR Keyway, Dark Oxidized Satin Bronze Equivalent	XSRX82-ARKD.613E
Storeroom, CS Keyway, Satin Chrome	XSRX82-CS-KD.26D
Storeroom, CS Keyway, Dark Oxidized Satin Bronze Equivalent	XSRX82-CSKD.613E
Storeroom, SFIC Prep, Satin Chrome	XSRX82-IC.26D
Storeroom, SFIC Prep, Dark Oxidized Satin Bronze Equivalent	XSRX82-IC.613E
Classroom, AR Keyway, Satin Chrome	XSRX87-AR-KD.26D
Classroom, AR Keyway, Dark Oxidized Satin Bronze Equivalent	XSRX87-ARKD.613E
Classroom, CS Keyway, Satin Chrome	XSRX87-CS-KD.26D
Classroom, CS Keyway, Dark Oxidized Satin Bronze Equivalent	XSRX87-CSKD.613E
Classroom, SFIC Prep, Satin Chrome	XSRX87-IC.26D
Classroom, SFIC Prep, Dark Oxidized Satin Bronze Equivalent	XSRX87-IC.613E
Plate Trim, Less Cylinder, Silver Aluminum Painted	AXX-SF12-LC.AL

Parts - ED910/PEC910	
Strike	X-ES90.FIN
Screw Pack, Satin Stainless Steel	X-ES9-201.32D
Screw Pack, Silver Aluminum Painted	X-ES9-201.AL
Screw Pack, Dark Bronze Painted	X-ES9-201.BRZ
End Cap, Satin Stainless Steel	X-ES9CAP.32D
End Cap, Silver Aluminum Painted	X-ES9CAP.AL
End Cap, Dark Bronze Painted	X-ES9CAP.BRZ
Installation Template	X-ES9TMPLT-36.FIN

DOOR CONTROL

DCN300, DCN500



ASSA ABLOY

Experience a safer
and more open world

Mechanical Door Closers & Operators

DCN300, Size 1-4, Non-Hold Open, Silver Aluminum Painted	AXU-DCN314.689
DCN300, Size 1-4, Non-Hold Open, Dark Bronze Painted	AXU-DCN314.690
DCN300 Size 1-4, Non-Hold Open, Black Painted	AXU-DCN314.693
DCN300, Size 1-4, Hold Open, Silver Aluminum Painted	AXU-DCN314-1.689
DCN300, Size 1-4, Hold Open, Dark Bronze Painted	AXU-DCN314-1.690
DCN300, Size 2-5, Non-Hold Open, Silver Aluminum Painted	AXU-DCN325.689
DCN300, Size 2-5, Non-Hold Open, Dark Bronze Painted	AXU-DCN325.690
DCN300 Size 2-5, Non-Hold Open, Black Painted	AXU-DCN325.693
DCN300, Size 2-5, Hold Open, Silver Aluminum Painted	AXU-DNC325-1.689
DCN300, Size 2-5, Hold Open, Dark Bronze Painted	AXU-DNC325-1.690
DCN500, Size 1-6, Non-Hold Open, PA Bracket, Silver Aluminum Painted	AXU-DCN516.689
DCN500, Size 1-6, Non-Hold Open, PA Bracket, Dark Bronze Painted	AXU-DCN516.690
DCN500 Size 1-6, Non-Hold Open, PA Bracket, Black Painted	AXU-DCN516.693
DCN500, Size 1-6, Hold Open, PA Bracket, Silver Aluminum Painted	AXU-DCN516-1.689
DCN500, Size 1-6, Hold Open, PA Bracket, Dark Bronze Painted	AXU-DCN516-1.690
DCN500, Size 1-6, Heavy-Duty Dead Stop Arm, Non-Hold Open, Silver Aluminum Painted	AXU-DCN516-2.689
DCN500, Size 1-6, Heavy-Duty Dead Stop Arm, Non-Hold Open, Dark Bronze Painted	AXU-DCN516-2.690
DCN500, Size 1-6, Heavy-Duty Dead Stop Arm, Hold Open, Silver Aluminum Painted	AXU-DCN516-3.689
DCN500, Size 1-6, Heavy-Duty Dead Stop Arm, Hold Open, Dark Bronze Painted	AXU-DCN516-3.690

DOOR CONTROL

DCN300, DCN500



Experience a safer
and more open world



Parts	
DCN300 Full Plastic Cover, Screw Pack, 1-3/8" Thru-Bolts, Silver Aluminum Painted	AXU-DCN3CVR.689
DCN300 Full Plastic Cover, Screw Pack, 1-3/8" Thru-Bolts, Dark Bronze Painted	AXU-DCN3CVR.690
DCN300 Full Plastic Cover, Black Painted	AXU-DCN3CVR.693
DCN500 Non-Hold Open Arm, Silver Aluminum Painted	AXU-DCN500A.689
DCN500 Non-Hold Open Arm, Dark Bronze Painted	AXU-DCN500A.690
DCN500 Non-Hold Open Arm, Black Painted	AXU-DCN500A.693
DCN500 Hold Open Arm, Silver Aluminum Painted	AXU-DCN500A1.689
DCN500 Hold Open Arm, Dark Bronze Painted	AXU-DCN500A1.690
DCN500 Heavy-Duty Dead Stop, Non-Hold Open Arm, Silver Aluminum Painted	AXU-DCN500A2.689
DCN500 Heavy-Duty Dead Stop, Non-Hold Open Arm, Dark Bronze Painted	AXU-DCN500A2.690
DCN500 Heavy-Duty Dead Stop, Hold Open Arm, Silver Aluminum Painted	AXU-DCN500A3.689
DCN500 Heavy-Duty Dead Stop, Hold Open Arm, Dark Bronze Painted	AXU-DCN500A3.690
DCN500 Heavy-Duty Cushion, Non-Hold Open Arm, Silver Aluminum Painted	AXU-DCN500A4.689
DCN500 Heavy-Duty Cushion, Non-Hold Open Arm, Dark Bronze Painted	AXU-DCN500A4.690
DCN500 Heavy-Duty Cushion, Hold Open Arm, Silver Aluminum Painted	AXU-DCN500A5.689
DCN500 Heavy-Duty Cushion, Hold Open Arm, Dark Bronze Painted	AXU-DCN500A5.690
DCN500 Full Plastic Cover, Silver Aluminum Painted	AXU-DCN500CV.689
DCN500 Full Plastic Cover, Dark Bronze Painted	AXU-DCN500CV.690
DCN500 Full Plastic Cover, Black Painted	AXU-DCN500CV.693
DCN500 Drop Plate, Silver Aluminum Painted	AXU-DCN500DP.689
DCN500 Drop Plate, Dark Bronze Painted	AXU-DCN500DP.690
DCN500 Drop Plate, Black Painted	AXU-DCN500DP.693
DCN500 Drop Plate for PA, Silver Aluminum Painted	AXU-DCN500DP1.689
DCN500 Drop Plate for PA, Dark Bronze Painted	AXU-DCN500DP1.690
DCN500 Drop Plate, Black Painted	AXU-DCN500DP1.693
DCN500 Drop Plate for Top Jamb, Silver Aluminum Painted	AXU-DCN500DP2.689
DCN500 Drop Plate for Top Jamb, Dark Bronze Painted	AXU-DCN500DP2.690
DCN500 Drop Plate for Top Jamb Flush Ceiling, Silver Aluminum Painted	AXU-DCN500DP3.689
DCN500 Drop Plate for Top Jamb Flush Ceiling, Dark Bronze Painted	AXU-DCN500DP3.690
DCN500 Screw Pack, Silver Aluminum Painted	AXU-DCN500SP.689
DCN500 Screw Pack, Dark Bronze Painted	AXU-DCN500SP.690
DCN500 Drop Plate, Black Painted	AXU-DCN500SP.693
DCN300/DCN500 Thru-Bolts for 1-3/4", Silver Aluminum Painted	AXU-DCNTB1.689
DCN300/DCN500 Thru-Bolts for 1-3/4", Dark Bronze Painted	AXU-DCNTB1.690
DCN300/DCN500 Thru-Bolts for 2-1/4", Silver Aluminum Painted	AXU-DCNTB2.689
DC300N/DCN500 Thru-Bolts for 2-1/4", Dark Bronze Painted	AXU-DCNTB2.690

Uncombined 6-Pin SFIC Cylinders	
Plain Front, 1D Keyway, Satin Chrome	AXP-100CRPUCX1D.26D
Plain Front, 1D Keyway, Satin Chrome	AXP-100CRPUCXAB.26D
Plain Front, DB Keyway, Satin Chrome	AXP-100CRPUCXDB.26D
Plain Front, EB Keyway, Satin Brass	AXP-100CRPUCXEB.04
Plain Front, EB Keyway, Satin Chrome	AXP-100CRPUCXEB.26D
Plain Front, FB Keyway, Satin Chrome	AXP-100CRPUCXFB.26D
Plain Front, GB Keyway, Satin Chrome	AXP-100CRPUCXGB.26D
Plain Front, HB Keyway, Satin Chrome	AXP-100CRPUCXHB.26D
Plain Front, JB Keyway, Satin Chrome	AXP-100CRPUCXJB.26D
Plain Front, KB Keyway, Satin Chrome	AXP-100CRPUCXKB.26D
Plain Front, LB Keyway, Satin Chrome	AXP-100CRPUCXLB.26D
Plain Front, MB Keyway, Satin Chrome	AXP-100CRPUCXMB.26D
Plain Front, QB Keyway, Satin Chrome	AXP-100CRPUCXQB.26D
Arrow Front, 1C Keyway, Satin Chrome	AXP-100CR-UCX1C.26D
Arrow Front, 1D Keyway, Satin Chrome	AXP-100CR-UCX1D.26D
Arrow Front, AB Keyway, Satin Brass	AXP-100CR-UCXAB.04
Arrow Front, AB Keyway, Satin Chrome	AXP-100CR-UCXAB.26D
Arrow Front, BB Keyway, Satin Chrome	AXP-100CR-UCXBB.26D
Arrow Front, CB Keyway, Satin Chrome	AXP-100CR-UCXCB.26D
Arrow Front, DB Keyway, Satin Brass	AXP-100CR-UCXDB.04
Arrow Front, DB Keyway, Satin Chrome	AXP-100CR-UCXDB.26D
Arrow Front, EB Keyway, Satin Chrome	AXP-100CR-UCXEB.26D
Arrow Front, FB Keyway, Satin Chrome	AXP-100CR-UCXFB.26D
Arrow Front, GB Keyway, Satin Chrome	AXP-100CR-UCXGB.26D
Arrow Front, HB Keyway, Satin Chrome	AXP-100CR-UCXHB.26D
Arrow Front, JB Keyway, Satin Chrome	AXP-100CR-UCXJB.26D
Arrow Front, KB Keyway, Satin Chrome	AXP-100CR-UCXKB.26D
Arrow Front, LB Keyway, Satin Chrome	AXP-100CR-UCXLB.26D
Arrow Front, MB Keyway, Satin Chrome	AXP-100CR-UCXMB.26D
Arrow Front, TD Keyway, Satin Chrome	AXP-100CR-UCXTD.26D

Uncombined 7-Pin SFIC Cylinders	
Plain Front, 1C Keyway, Satin Chrome	AXP-7100CRPUCX1C.26D
Plain Front, 1D Keyway, Satin Chrome	AXP-7100CRPUCX1D.26D
Plain Front, AB Keyway, Satin Chrome	AXP-7100CRPUCXAB.26D
Plain Front, DB Keyway, Satin Chrome	AXP-7100CRPUCXDB.26D
Plain Front, EB Keyway, Satin Chrome	AXP-7100CRPUCXEB.26D
Plain Front, FB Keyway, Satin Chrome	AXP-7100CRPUCXFB.26D
Plain Front, GB Keyway, Satin Chrome	AXP-7100CRPUCXGB.26D
Plain Front, HB Keyway, Satin Chrome	AXP-7100CRPUCXHB.26D
Plain Front, JB Keyway, Satin Chrome	AXP-7100CRPUCXJB.26D
Plain Front, KB Keyway, Satin Chrome	AXP-7100CRPUCXKB.26D
Plain Front, LB Keyway, Satin Chrome	AXP-7100CRPUCXLB.26D
Plain Front, MB Keyway, Satin Chrome	AXP-7100CRPUCXMB.26D
Plain Front, QB Keyway, Satin Chrome	AXP-7100CRPUCXQB.26D
Plain Front, RB Keyway, Satin Chrome	AXP-7100CRPUCXRB.26D
Plain Front, TB Keyway, Satin Chrome	AXP-7100CRPUCXTB.26D
Plain Front, WB Keyway, Satin Chrome	AXP-7100CRPUCXWB.26D
Plain Front, WC Keyway, Satin Chrome	AXP-7100CRPUCXWC.26D
Arrow Front, 1C Keyway, Satin Chrome	AXP-7100CR-UCX1C.26D
Arrow Front, 1D Keyway, Satin Chrome	AXP-7100CR-UCX1D.26D
Arrow Front, AB Keyway, Satin Chrome	AXP-7100CR-UCXAB.26D
Arrow Front, DB Keyway, Satin Brass	AXP-7100CR-UCXDB.04
Arrow Front, DB Keyway, Satin Chrome	AXP-7100CR-UCXDB.26D
Arrow Front, EB Keyway, Satin Brass	AXP-7100CR-UCXEB.04
Arrow Front, EB Keyway, Satin Chrome	AXP-7100CR-UCXEB.26D
Arrow Front, FB Keyway, Satin Chrome	AXP-7100CR-UCXFB.26D
Arrow Front, GB Keyway, Satin Chrome	AXP-7100CR-UCXGB.26D
Arrow Front, HB Keyway, Satin Chrome	AXP-7100CR-UCXHB.26D
Arrow Front, JB Keyway, Satin Chrome	AXP-7100CR-UCXJB.26D
Arrow Front, KB Keyway, Satin Chrome	AXP-7100CR-UCXKB.26D
Arrow Front, LB Keyway, Satin Chrome	AXP-7100CR-UCXLB.26D
Arrow Front, MB Keyway, Satin Chrome	AXP-7100CR-UCXMB.26D
Arrow Front, QB Keyway, Satin Chrome	AXP-7100CR-UCXQB.26D

SFIC Housings	
Mortise Housing, 6-Pin, 001 Cam, Satin Chrome	AXP-16CR-16X001.26D
Mortise Housing, 7-Pin, 001 Cam, Satin Chrome	AXP-16CR-27X001.26D
Mortise Housing, 7-Pin, 004 Cam, Satin Chrome	AXP-16CR-27X004.26D
Mortise Housing, 7-Pin, 004 Cam, Satin Chrome	AXP-16CR-27X006.26D
Mortise Housing, 7-Pin, AR18 Cam, Satin Chrome	AXP-16CR-27XAR18.26D
Rim Housing, 7-pin, Satin Chrome	AXP-16RCR-27.26D

Key Blanks

1C Keyway, Classic Bow	AXPK-C1C.NS
1D Keyway, Classic Bow	AXPK-C1D.NS
1C Keyway, Choice Bow	AXPK-CH1C.NS
1D Keyway, Choice Bow	AXPK-CH1D.NS
1C Keyway, Choice bow	AXPK-CH1C.NS
1D Keyway, Choice bow	AXPK-CH1D.NS
AB Keyway, Classic Bow	AXPK-CAB.NS
JB Keyway, Classic Bow	AXPK-CJB.NS
QB Keyway, Classic Bow	AXPK-CQB.NS
WC Keyway, Generic Bow	AXPK-GBWC.NS
AR Keyway, 5-Pin	AXPK-K5A.BS
AR Keyway, 6-Pin	AXPK-K6A.NS

SFIC Padlocks (cylinder not included)

1" Shackle	AXP-EPC1-IC.FIN
3" Shackle	AXP-EPC3-IC.FIN



ASSA ABLOY

Experience a safer
and more open world

The ASSA ABLOY Group is the global leader in access solutions. Every day, we help billions of people experience a more open world.

ASSA ABLOY Opening Solutions leads the development within door openings and products for access solutions in homes, businesses and institutions. Our offering includes doors, frames, door and window hardware, mechanical and smart locks, access control and service.



For more information regarding Arrow locksets, exit devices, door closers and key systems, contact your authorized Arrow distributor.



[Facebook](#)



[E-Newsletter Signup](#)



[LinkedIn Signup](#)

ARROW USA

Phone: 800-327-8539

Fax: 866-636-9995

orders.arrow@assaabloy.com

Visit us at our Website:

www.arrowlock.com

Copyright © 2023-2025, ASSA ABLOY Access and Egress Hardware Group, Inc. All rights reserved. Reproduction in whole or in part without the express written permission of ASSA ABLOY Access and Egress Hardware Group, Inc. is prohibited.



ASSA ABLOY

Experience a safer
and more open world



Competitor Indicator Kits

Best® and Schlage® Mortise Locks



Features:

- Can be mounted on the inside, outside or both sides of the door
- Available for a variety of Best® and Schlage® functions
- Large viewing window
- Patented curved design for viewing at multiple angles
- Window located prominently above the cylinder
- Highly reflective viewing window for increased safety
- Multiple color, text, graphic and language combinations available
- Covers existing Best® or Schlage® sectional trim indicator preps
- Two-year warranty.

Typical Applications:

- Classroom doors
- Privacy rooms
- Nursing/new mother rooms
- Patient rooms
- Restrooms
- Meeting rooms

Indicators can be used in a variety of applications and are most commonly used to identify occupancy or display the locked/unlocked status of a room. Upgrade existing Best® or Schlage® mortise locks with a retrofit indicator kit from Arrow.

These kits offer a seamless upgrade to existing sectional mortise locks to add security and privacy.

Certification:

UL/cUL Classified for use on 3 hr doors using Schlage® L9000 or Best® 45H/34H/35H mortise locks



*Cylinder not included.

WARNING

This product can expose you to lead which is known to the state of California to cause cancer and birth defects or other reproductive harm. For more information go to www.P65warnings.ca.gov.

Finishes:

Arrow Code	BHMA	U.S. Equiv.	Finish Description	
605	605	US3	Bright Brass	
606	606	US4	Satin Brass	
612	612	US10	Satin Bronze	
613E	613E	US10BE	Dark Oxide Bronze Equivalent	

Arrow Code	BHMA	U.S. Equiv.	Finish Description	
618	618		Bright Nickel Plated, Clear Coated	
619	619	US15	Nickel Plated	
625	613	US26	Bright Chromium Plated	
626	626	US26D	Satin Chromium Plated	

Note: All finishes will be provided per Arrow color standards. Arrow does not guarantee finish will match to Best® or Schlage® finish.

1. Indicator escutcheon nickel plated to match stainless steel.

Indicator Option Codes:

Mortise indicator option codes are designed to convey wording and color in one simple code.



V10



V40



V20



V50

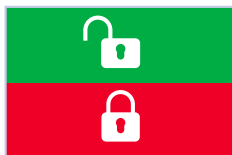

V30



V60

Option Code	Wording	Color
V10	Unlocked/Locked	Green/Red
V20	Vacant/Occupied	Green/Red
V30	Icons Only	Green/Red
V40	Unlocked/Locked	White/Red
V50	Vacant/Occupied	White/Red
V60	Icons Only	White/Red

Best® Mortise Locks:

Sectional trim indicator kits are available to retrofit to Best® 45H, 34H or 35H series mortise locks. Kits can be ordered to be used on the inside, outside or both sides of the door. Each kit includes a single side indicator plate with mechanism, screw pack, plastic template and instructions.

- Kits available for use on sectional trim installations only
- Can only be used with H or R roses. Roses greater than 3-1/4" in diameter cannot be used.
- Thumbturn design will be the standard Arrow thumbturn
- L and LT privacy functions will use a coin turn for emergency override

The following chart details the functions that can be accommodated.

Best® Function	Illustration	Description	Outside	Inside	
L		Privacy F19	ABE193 	ABE194 	
LT		Privacy			
AB		Office F20	ABE190* 		
AT		Office F04			
RD		Classroom DL F29			
TA		Dormitory F12			
TD		Dormitory			
IND		Intruder F33			ABE190*
INL		Intruder F32			

*Cylinder not included. Accepts a standard 1-1/8" mortise cylinder.

Function numbers, illustrations and descriptions above are from the Best® 40H series catalog. Refer to that catalog for more information and function details.

Schlage® Mortise Locks:

Sectional trim indicator kits are available to retrofit to Schlage® L series mortise locks. Kits can be ordered to be used on the inside, outside or both sides of the door. Each kit includes a single side indicator plate with mechanism, screw pack, plastic template and instructions.

- Kits available for use on sectional trim installations only
- Can be used with A, B, C, AVA or MER roses. Roses greater than 3-1/4" in diameter cannot be used.
- Thumbturn design will be the standard Arrow thumbturn
- L/LV9040 and L/LV9044 privacy functions will use a coin turn for emergency override

The following chart details the functions that can be accommodated.

Schlage® Function	Illustration	Description	Outside	Inside
L/LV9040		Privacy F22	ASC193 	ASC194
L/LV9044		Privacy		
L/LV9050		Office F04	ASC190* 	
L/LV9456		Corridor F13		
L9473		Dormitory F21		
L/LV9060		Apartment Entrance Lock F09	ASC190* 	
L/LV9071		Classroom Security F32		
L/LV9077		Classroom Security Holdback		
L/LV9457		Classroom Security F33		
L/LV9458		Classroom Security F34		
L9466		Store/utility Room Lock with Deadbolt F14		
L/LV9070		Classroom Lock F05		ASC197

*Cylinder not included. Accepts a standard 1-1/8" mortise cylinder.

Function numbers, illustrations and descriptions above are from the Schlage® L series catalog. Refer to that catalog for more information and function details.

Competitor Indicator Kits



ASSA ABLOY

How To Order:

To order, specify by model number. Indicator option code must be specified with each kit.

Standard door thickness is 1-3/4".

Competitor indicator kits are handed and easily field reversible. All units are shipped from the factory with a default handing. Handing must be field verified and adjusted as needed per product installation instructions.

Best®

Model Number	Door Thickness	Finish	Option Code
ABE190	1-3/4"	626	V10

Schlage®

Model Number	Door Thickness	Finish	Option Code
ASC190	1-3/4"	626	V10

Note: Indicators for both sides of the door require two kits.

Parts:

Replacement parts are available as follows:

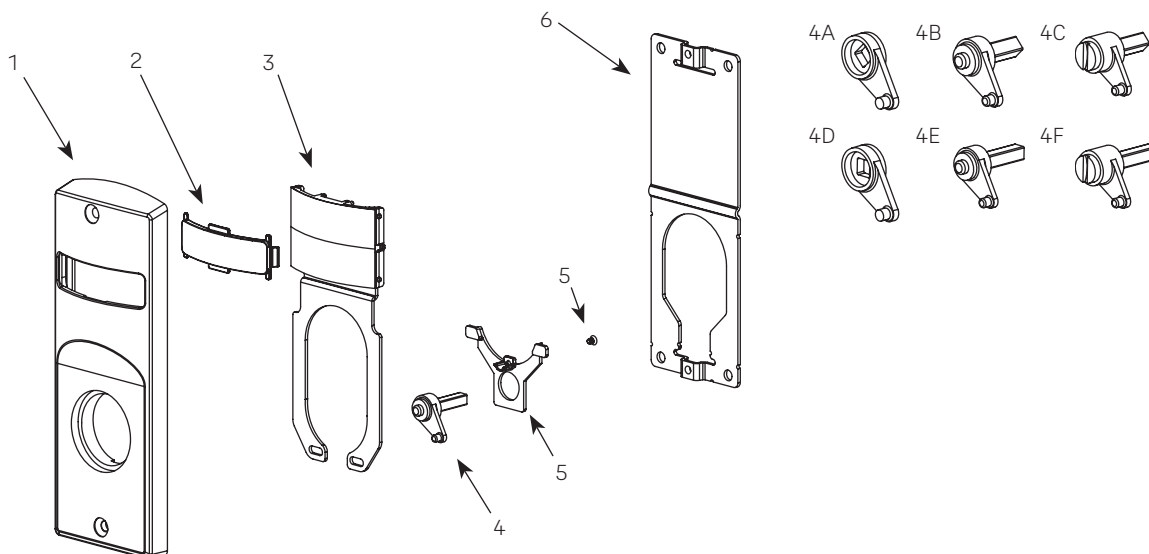

ITEM #	DESCRIPTION	PART NUMBER
1	Best® Sectional Escutcheon - Cylinder	50-8800-2304 x Finish
	Schlage® Sectional Escutcheon - Cylinder	50-8800-2303 x Finish
	Best Sectional Escutcheon - Thumbturn (includes thumbturn)	50-8800-0390* x Finish
	Schlage Sectional Escutcheon - Thumbturn (includes thumbturn)	50-8800-0389* x Finish
	Best or Schlage Sectional Escutcheon - Cointurn (cointurn not included)	50-8800-2301 x Finish
	Best or Schlage Sectional Escutcheon - No Input / Blank	50-8800-2302 x Finish
2	Indicator Window	856F049
3	Display Assembly - Green Unlocked / Red Locked	858F241
	Display Assembly - Green Vacant / Red Occupied	858F251
	Display Assembly - Green Unlocked Icon / Red Locked Icon	858F261
	Display Assembly - White Unlocked / Red Locked	858F271
	Display Assembly - White Vacant / Red Occupied	858F281
	Display Assembly - White Unlocked Icon / Red Locked Icon	858F291
	Display Assembly - Green Ouvert / Red Fermé	865F241
	Display Assembly - Green Libre / Red Occupée	865F251
4A	Best Spindle Cam - Thumbturn	855F619
4B	Best Spindle Cam - Cylinder / No Input / Blank	855F707*
4C	Best Spindle Cam - Cointurn (includes cointurn)	855F747* x Finish
4D	Schlage Spindle Cam - Thumbturn	50-8800-9322
4E	Schlage Spindle Cam - Cylinder / No Input / Blank	50-8800-7314*
4F	Schlage Spindle Cam - Cointurn (includes cointurn)	50-8800-7318* x Finish
5	Retaining Pad and Screw Kit	50-8800-0391
7	Mounting Plate	855F658
Not Shown	Screw Pack	858F497 x Finish
Not Shown	Template Kit	50-8800-9327

*These parts are for 1-3/4" standard thickness doors. For other thicknesses, please contact factory.

Competitor Indicator Kits



ASSA ABLOY

The ASSA ABLOY Group is the global leader in access solutions. Every day, we help billions of people experience a more open world.

ASSA ABLOY Opening Solutions leads the development within door openings and products for access solutions in homes, businesses and institutions. Our offering includes doors, frames, door and window hardware, mechanical and smart locks, access control and service.



ASSA ABLOY

Arrow Lock & Door Hardware
225 Episcopal Road
Berlin, CT 06037
Customer Service: 1-800-327-8539
Technical Product Support: 1-800-327-8539 X2
www.arrowlock.com