

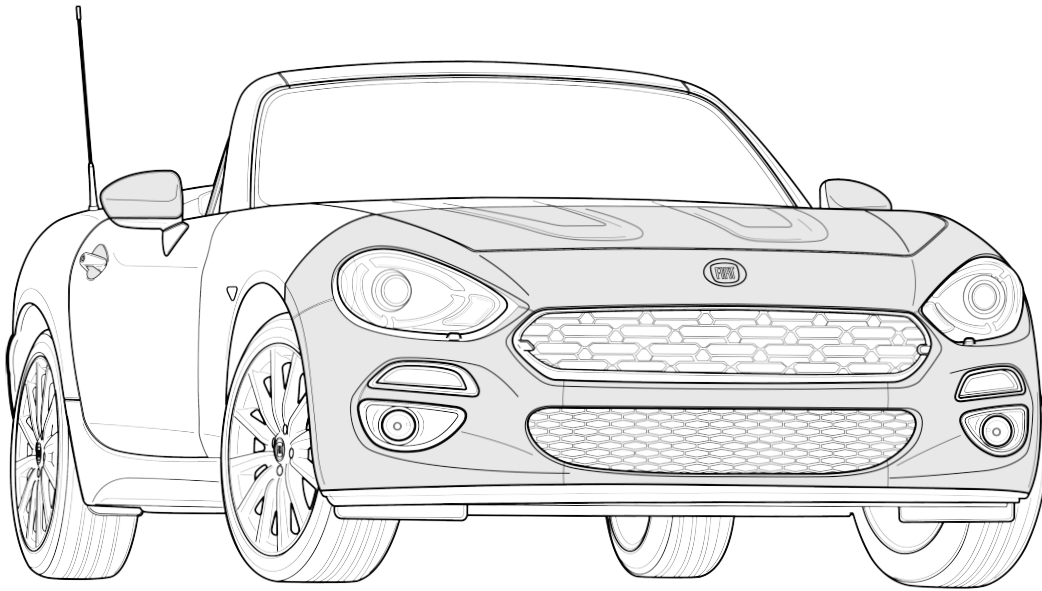

Fiat 124 Spider Classica / Lusso Paint Protection Film



EN

PAINT PROTECTION FILM
Installation Instruction

DE

FARBSCUTZFOLIE
Einbauanleitung

ES

PELÍCULA DE PROTECCIÓN DE PINTURA
Instrucciones de montaje

FR

FILM DE PROTECTION DE LA PEINTURE
Instructions de montage

IT

PELLICOLA DI PROTEZIONE DELLA VERNICE
Istruzioni di montaggio

Part No: 82215021

© Copyright 2016

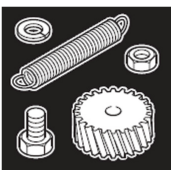

www.dealers-mopar.com/international-accessory-catalog/

Subject to alteration without notice,
for latest status check internet site
Technische Änderungen vorbehalten
Reservadas modificaciones técnicas
Sous réserve de modifications techniques
Con riserva di apportare modifiche tecniche

Expert Fitment Required
Montage durch Fachwerkstatt erforderlich
Montaje sólo por el concesionario
Montage par spécialiste nécessaire
E' necessario in officina specializzata

EN Preparation

MOPAR Paint Protection Film (PPF) is intended for use on any fully cured OEM paint surface. Application using the wet method is required. Application of the PPF on repainted surface should only be installed if the surface has been prepared and painted by a professional according to OEM recommendations, and a complete cure and bond of the paint has occurred.

1. Read all instructions before beginning application.
2. Install at temperatures between 18°C and 32°C
3. Do not apply in direct sunlight or windy conditions.
4. Work in a clean/dust free area, away from doors / windows and HVAC vents.
5. Work with clean hands and keep fingers and film wet during installation.
6. Prepare Cleaning/Tack Solution:
 - In one spray bottle combine 3 parts water to 2 parts isopropyl alcohol (60/40 ratio).
7. Prepare Soap/Slip Solution:
 - In second spray bottle, add 3-4 drops of Baby Shampoo to one liter of water.
 - NOTE: Proper mix will sheet on the painted surface but not form soap bubbles.

General Application Instructions

1. Thoroughly clean part surface with Cleaning/Tack Solution and a clean, soft cloth.
 - A clay bar may be used to remove any surface contamination.
2. The recommended parts sequence is to work from top to bottom, applying hood first, followed by fenders, finishing with grille / fascia parts.
3. Refer to part schematic attached for locating / application sequence for each of the individual parts included in this kit.
4. Place paint protection film appliqué, film side down on a clean flat surface.
 - Wet painted surface and hands/fingers using Soap/Slip Solution.
 - Remove liner from first piece to be applied.
 - Wet the adhesive side of film with Soap/Slip Solution.
5. The film can be lifted and repositioned repeatedly if the painted surface and the adhesive side of the film are kept well lubricated with Soap/Slip Solution.
6. Once the film is correctly positioned, lift and spray the sections to be affixed with the Cleaning / Tack Solution to displace the Soap/Slip Solution, and squeegee film into place with firm overlapping strokes that move water solutions from center to film edge & evacuation.

DE Vorbereitung

Die **MOPAR-Farbschutzfolie** wurde zur Anwendung auf beliebigen, vollständig getrockneten Originalfarboberflächen entwickelt.

Das Material ist mithilfe von Lösungen aufzutragen. Die Farbschutzfolie sollte nur auf einer neu lackierten Oberfläche angebracht werden, wenn diese entsprechend der Empfehlungen für das Originalprodukt von Fachpersonal präpariert und lackiert wurde und die Farbe vollständig getrocknet und angehaftet ist.

1. Lesen Sie die Anleitung vollständig durch, bevor Sie mit dem Anbringen beginnen.
2. Bringen Sie das Material bei Temperaturen zwischen 18 °C und 32 °C an.
3. Bringen Sie das Material nicht bei direkter Sonneneinstrahlung oder Wind an.
4. Arbeiten Sie in einem sauberen/staubfreien Bereich, nicht in unmittelbarer Nähe von Türen/Fenstern oder HLK-Schlitten.
5. Führen Sie die Arbeit mit sauberen Händen durch und halten Sie Ihre Finger sowie die Materialschicht während des Anbringens feucht.
6. Reinigungs-/Haftlösung zubereiten:
 - Mischen Sie in einer Sprühflasche Wasser und Isopropanol im Verhältnis 3:2 (Verhältnis 60:40).
7. Seifen-/Rutschlösung zubereiten:
 - Mischen Sie in einer zweiten Sprühflasche 1 Liter Wasser mit 3 - 4 Tropfen Baby-Shampoo.
 - HINWEIS: Die richtige Mischung bildet auf der lackierten Oberfläche einen Film, aber keine Seifenblasen.

Allgemeine Anweisungen zum Anbringen

1. Reinigen Sie die Teiloberfläche gründlich mit der Reinigungs-/Haftlösung und einem sauberen, weichen Tuch.
 - Möglicherweise benötigen Sie einen Lackpflegeschwamm, um die Oberfläche von sämtlichen Verunreinigungen zu befreien.
2. Die empfohlene Reihenfolge der Teile ist von oben nach unten, beginnend bei der Motorhaube, gefolgt von den Kotflügeln und schließlich dem Kühlergrill/der Armatur.
3. Sehen Sie in der angefügten Teileansicht nach, um Informationen zur Reihenfolge und dem Ort der einzelnen in diesem Satz enthaltenen Teile zu erhalten.
4. Legen Sie die Farbschutzfolie-Applikation mit der nicht klebenden Seite nach unten auf eine saubere, glatte Oberfläche.
 - Befeuchten Sie die lackierte Oberfläche sowie Ihre Finger/Hände mit Seifen-/Rutschlösung.
 - Entfernen Sie die Schutzfolie vom ersten Teil, das behandelt werden soll.
 - Befeuchten Sie die klebende Seite der Folie mit Seifen-/Rutschlösung.
5. Wenn Sie die lackierte Oberfläche und die klebende Seite des Films gut mit Seifen-/Rutschlösung schmieren, können Sie den Film immer wieder abziehen und neu anbringen.
6. Befindet sich die Folie an der richtigen Stelle, besprühen Sie die zu befestigenden Abschnitte mit der Reinigungs-/Haftlösung, um die Seifen-/Rutschlösung zu ersetzen. Dann streichen sie die Folie kräftig und schnell glatt, um Wasser aus der Mitte an den Rand der Folie zu drücken und es zu entfernen.

ES Preparación

La **película de protección de pintura MOPAR (PPF)** está destinada para su uso en cualquier superficie de pintura de fabricantes de equipos originales totalmente seca.

Se requiere su aplicación en mojado. La aplicación de la película PPF en una superficie pintada solo debe llevarse a cabo si la superficie ha sido preparada y pintada por un profesional de acuerdo con las recomendaciones de los fabricantes de equipos originales y si la pintura está totalmente seca y adherida.

1. Lea todas las instrucciones antes de comenzar con la aplicación.
2. Utilizar a temperaturas de entre 18 °C y 32 °C.
3. No aplicar bajo la luz directa del sol ni en condiciones de viento.
4. Trabaje en un área limpia y sin polvo, lejos de puertas, ventanas y de conductos de climatización.
5. Trabaje con las manos limpias y mantenga los dedos y la película húmedos durante la aplicación.
6. Prepare la solución de limpieza:
 - En una botella con aerosol mezcle tres partes de agua con dos partes de alcohol isopropílico (proporción 60/40).
7. Prepare la solución jabonosa:
 - En una segunda botella con aerosol, añada 3-4 gotas de champú para niños a un litro de agua.
 - NOTA: La mezcla correcta creará una película en la superficie pintada pero no formará espuma.

Instrucciones generales de aplicación

1. Limpie completamente la superficie con la solución de limpieza y un paño limpio y suave.
 - Se puede utilizar una barra de plastilina para eliminar la suciedad de la superficie.
2. La secuencia de piezas recomendada es trabajar desde arriba hacia abajo, empezando por el capó, siguiendo por el parachoques y terminando por las piezas de la rejilla y el tablero.
3. Consulte el esquema de piezas adjunto para ver o ubicar la secuencia de aplicación para cada una de las piezas individuales incluidas en este kit.
4. Coloque la película de protección de pintura con apliques con la cara de la película hacia abajo en una superficie limpia y plana.
 - Humedezca la superficie pintada y las manos/dedos utilizando la solución jabonosa.
 - Retire el revestimiento de la primera pieza en la que se va a aplicar.
 - Humedezca la parte adhesiva de la película con la solución jabonosa.
5. La película se puede levantar y volver a colocar varias veces si la superficie pintada y la cara adhesiva de la película se mantienen lubricadas con la solución jabonosa.
6. Cuando la película esté correctamente colocada, levante y pulverice con el aerosol la solución de limpieza en las secciones a adherir para eliminar la solución jabonosa. Escurra la película mediante golpes firmes solapados que moverán y retirarán la solución de agua desde el centro hacia los bordes de la película.

FR Préparation

Le film de protection de la peinture MOPAR (FPP) est destiné à être utilisé sur toutes les surfaces de peinture OEM.

L'application doit être effectuée au moyen de la méthode « humide ». L'application du FPP sur une surface repeinte doit uniquement être effectuée si la surface a été préparée et peinte par un professionnel conformément aux recommandations des OEM, et si un durcissement et une adhérence complets de la peinture ont été constatés.

1. Lisez toutes les instructions avant de procéder à l'application.
2. Installez le film à une température comprise entre 18 °C et 32 °C
3. Ne l'appliquez pas à la lumière directe du soleil ou lorsqu'il y a du vent.
4. Travaillez dans une zone propre / sans poussière et tenez-vous éloigné des portes / fenêtres et des systèmes CVCA.
5. Travaillez avec des mains propres et assurez-vous que vos doigts et le film restent humides durant l'installation.
6. Préparez une solution de nettoyage / collante :
 - Dans un pulvérisateur, associez 3 mesures d'eau et 2 mesures d'alcool d'isopropyle (ratio 60/40).
7. Préparez une solution à base de savon / glissante :
 - Dans un deuxième pulvérisateur, ajoutez 3 à 4 gouttes de shampoing pour bébé dans un litre d'eau.
 - REMARQUE : Un mélange effectué correctement s'étalera sur la surface peinte mais ne formera pas de bulles de savon.

Instructions générales relatives à l'application

1. Nettoyez minutieusement la surface de la pièce à l'aide de la solution de nettoyage / collante et d'un chiffon propre et doux.
 - Un savon à l'argile peut être utilisé pour enlever toute contamination de la surface.
2. Il est recommandé de travailler du haut vers le bas, en appliquant d'abord la solution sur le capot, puis sur les ailes, et en terminant par les pièces de la calandre / planche de bord.
3. Reportez-vous au schéma des pièces ci-joint pour connaître l'emplacement / l'ordre d'application de chaque pièce comprise dans ce kit.
4. Appliquez le film de protection de la peinture sur une surface plane et propre tout en orientant le côté du film vers le bas.
 - Mouillez la surface peinte et vos mains / doigts à l'aide de la solution à base de savon / glissante.
 - Enlevez le revêtement de la première pièce sur laquelle doit être appliqué le film.
 - Mouillez le côté adhésif du film avec la solution à base de savon / glissante.
5. Le film peut être soulevé et repositionné plusieurs fois si la surface peinte et le côté adhésif du film sont bien lubrifiés avec la solution à base de savon / glissante.
6. Une fois le film correctement positionné, soulevez et aspergez les parties sur lesquelles appliquer le film avec la solution de nettoyage / collante pour recouvrir la solution à base de savon / glissante. Raclez le film pour le mettre en place en donnant des coups fermes les uns sur les autres afin d'évacuer les solutions aqueuses en les déplaçant du centre vers le bord du film.

IT Preparazione











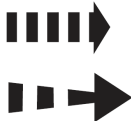



La pellicola di protezione della vernice (PPF) MOPAR è pensata per l'utilizzo su qualsiasi superficie rivestita da vernice di qualità OEM completamente polimerizzata.

Deve essere applicata utilizzando il metodo bagnato. L'applicazione sulla pellicola di protezione della vernice su superfici riverniciate deve essere attuata solo se la superficie è stata preparata e verniciata da un professionista, in base alle raccomandazioni dell'OEM, e solo in caso di polimerizzazione completa e legame della vernice.

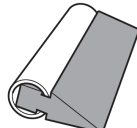
1. Leggere tutte le istruzioni prima di iniziare l'applicazione.
2. Installare a temperature comprese tra i 18 °C e i 32 °C
3. Non applicare alla luce diretta del sole o in presenza di vento.
4. Lavorare in un'area pulita/priva di polvere, lontano da porte/finestre e sfiiati dell'impianto di climatizzazione.
5. Lavorare con mani pulite e mantenere le dita e la pellicola bagnati durante l'installazione.
6. Preparare una soluzione detergente/adesiva:
 - In un flacone spray, combinare 3 parti di acqua con 2 parti di alcool isopropilico (rapporto 60/40).
7. Preparare una soluzione saponosa/scivolosa:
 - In un secondo flacone spray, aggiungere 3-4 gocce di shampoo per bambini a un litro di acqua.
 - NOTA: Una miscelazione adeguata rivestirà la superficie verniciata ma non formerà bolle di sapone.

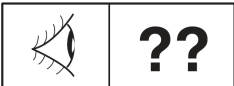
Istruzioni generali per l'applicazione

1. Pulire accuratamente la superficie con una soluzione detergente/adesiva e un panno pulito e morbido.
 - È possibile utilizzare una saponetta di argilla per rimuovere eventuali contaminazioni della superficie.
2. La sequenza consigliata è di lavorare dall'alto verso il basso, applicando prima sul cofano, seguito dai paraurti, e terminando con le griglie/il cruscotto.
3. Fare riferimento allo schema delle parti allegato per individuare/per la sequenza di applicazione per ciascuna delle singole parti incluse nel presente kit.
4. Posizionare l'applicazione della pellicola di protezione della vernice, con il lato della pellicola verso il basso su una superficie piatta e pulita.
 - Superficie verniciata bagnata e mani/dita che utilizzano la soluzione saponosa/scivolosa.
 - Rimuovere il rivestimento dal primo pezzo sul quale eseguire l'applicazione.
 - Inumidire il lato adesivo della pellicola con la soluzione saponosa/scivolosa.
5. La pellicola può essere sollevata e riposizionata ripetutamente se la superficie verniciata e il lato adesivo della pellicola sono mantenuti ben lubrificati con una soluzione saponosa/scivolosa.
6. Una volta che la pellicola è correttamente posizionata, sollevare e spruzzare le sezioni sulle quali applicare la soluzione detergente/adesiva per sostituire la soluzione saponosa/scivolosa e asciugare con il tergitristalli la pellicola in posizione con colpi fermi per spostare le soluzioni di acqua dal centro al bordo della pellicola, consentendone l'evacuazione.

 <p> (EN) Movement Arrow (DE) Bewegungspfeil (ES) Flecha de movimiento (FR) Flèche indiquant le sens du mouvement (IT) Freccia di movimento </p>	 <p> (EN) Kit parts with quantity (DE) Kitteile mit Anzahl (ES) Piezas del kit y cantidad (FR) Element de kit et quantité (IT) Componenti del Kit e quantità </p>	 <p> (EN) Fitting Step (DE) Einbauschnitt (ES) Número de paso (FR) Etape (IT) Operazione di adattamento </p>
 <p> (EN) Location/Position Arrow (DE) Positionspfeil (ES) Flecha de posición (FR) Flèche de Position (IT) Freccia di posizione </p>	 <p> (EN) 2x1 spray bottles (DE) 2x1 Sprühflasche (ES) 2x1 botella con aerosol (FR) 2x1 pulvérisateur (IT) 2x1 flacone spray </p>	 <p> (EN) Isopropyl Alcohol (DE) Isopropanol (ES) Alcohol isopropilico (FR) Alcool d'isopropyle (IT) Alcool isopropilico </p>
 <p> (EN) Baby shampoo (DE) Baby-Shampoo (ES) Champú para niños (FR) Shampoing pour bébé (IT) Shampoo per bambini </p>	 <p> (EN) Soft cloth (DE) weichen Tuch (ES) Paño suave (FR) Chiffon doux (IT) Panno morbido </p>	 <p> (EN) Squeegee (DE) Wischer (ES) Escobilla de goma (FR) Raclette (IT) Seccatoio </p>
 <p> (EN) Warning (DE) Achtung (ES) Atención (FR) Attention (IT) Attenzione </p>	 <p> (EN) Refer to specific view (DE) Siehe Abbildung (ES) Ver figura (FR) Cf. figure (IT) Vedi figura </p>	 <p> (EN) Repeat (DE) Wiederholen (ES) Repetir (FR) Répéter (IT) Ripetere </p>
 <p> (EN) Correct (DE) Richtig (ES) Correcto (FR) Correct (IT) Corretto </p>	 <p> (EN) Incorrect (DE) Falsch (ES) Incorrecto (FR) Incorrect (IT) Scorretto </p>	

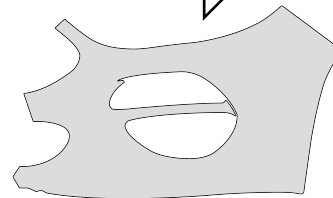
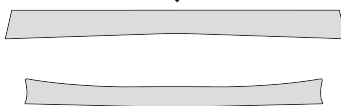
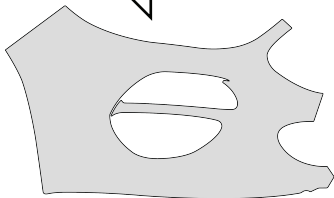
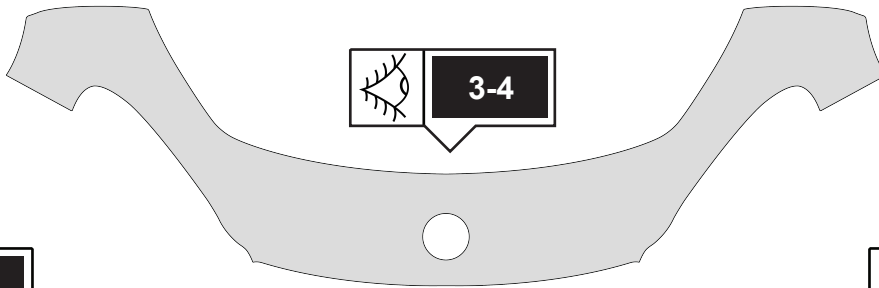
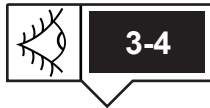
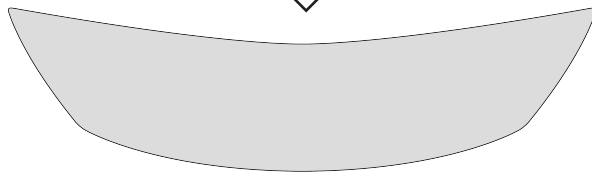
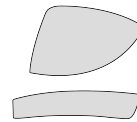
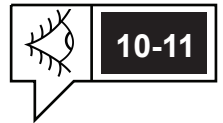
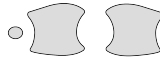
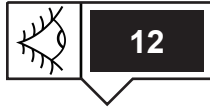
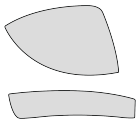
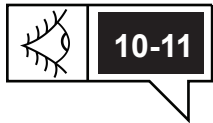
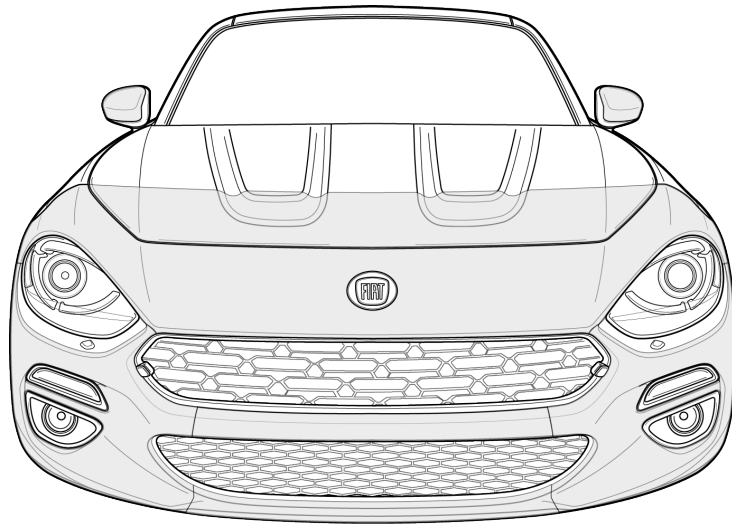



1-2

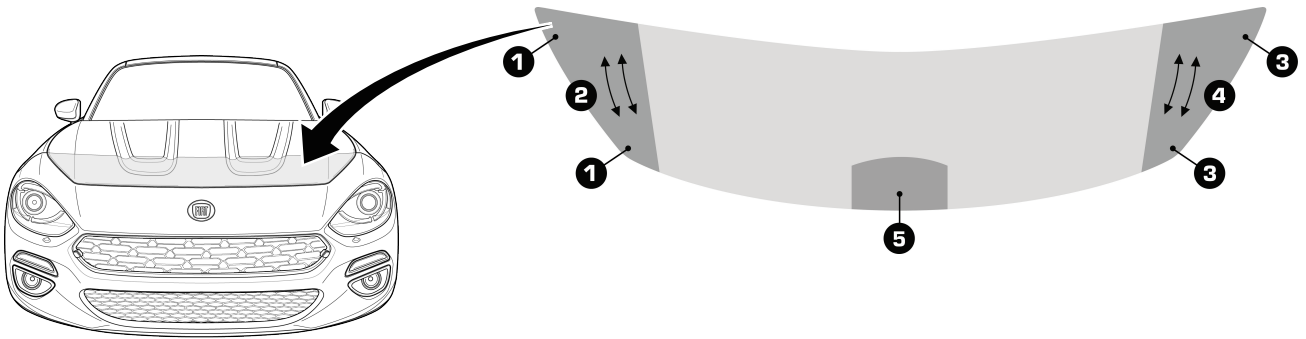

1

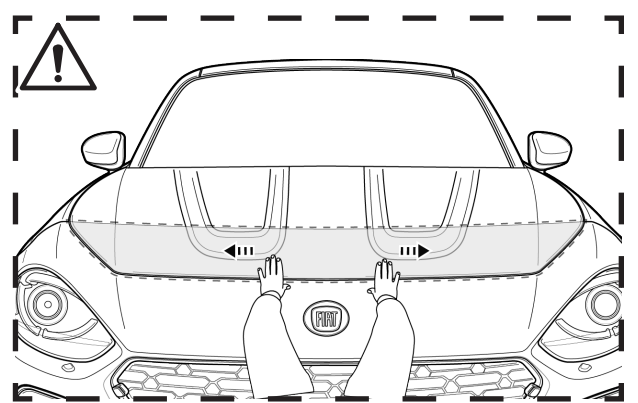
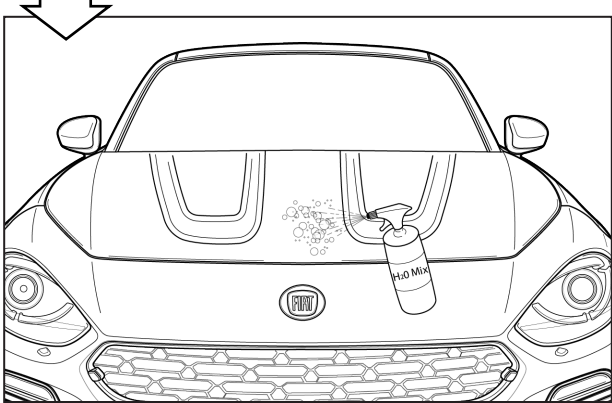

2

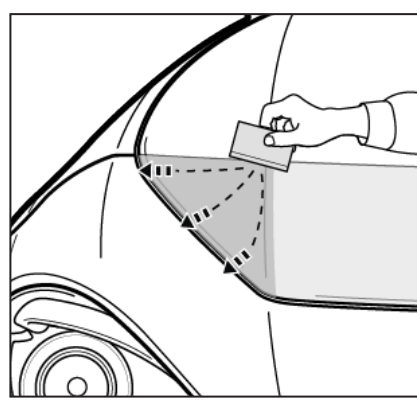
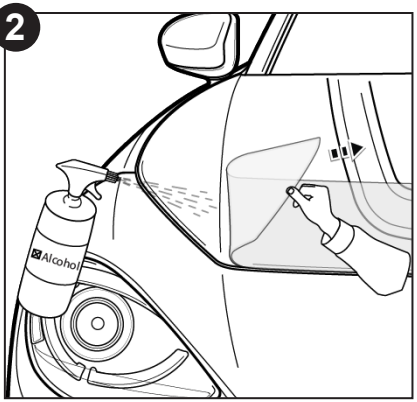

3

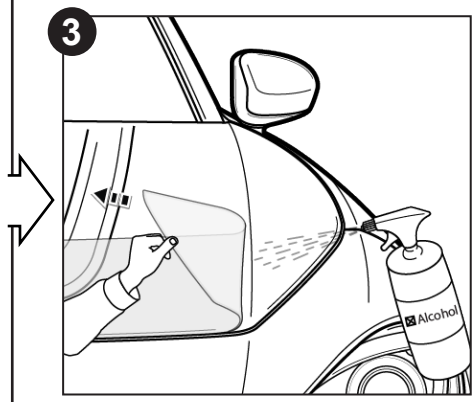

4

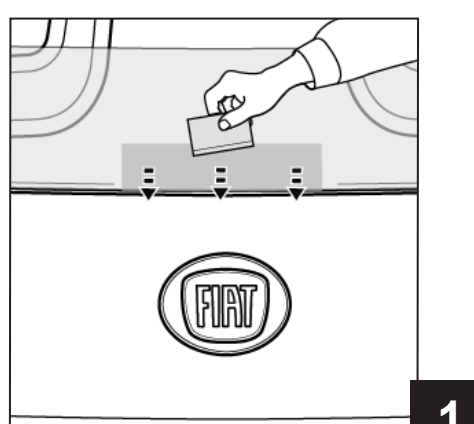
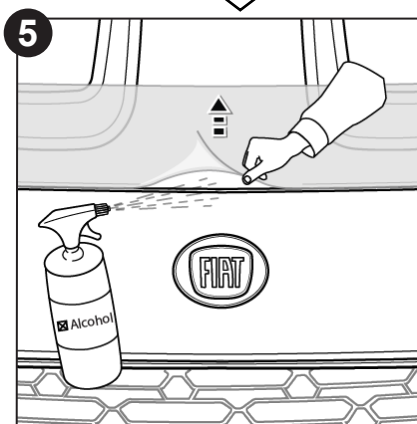
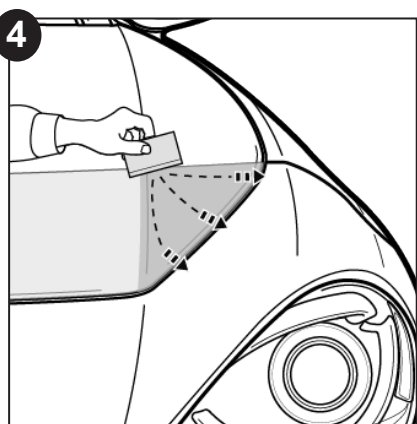

1



1-2

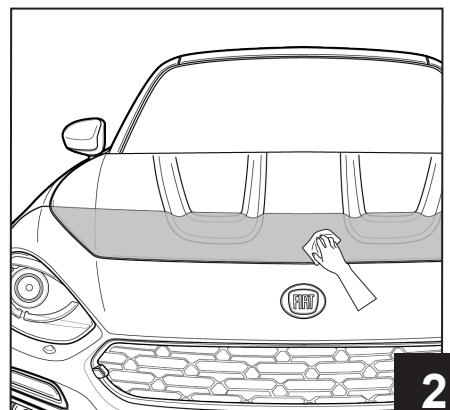
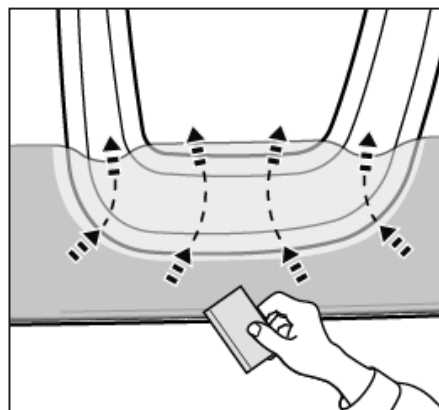
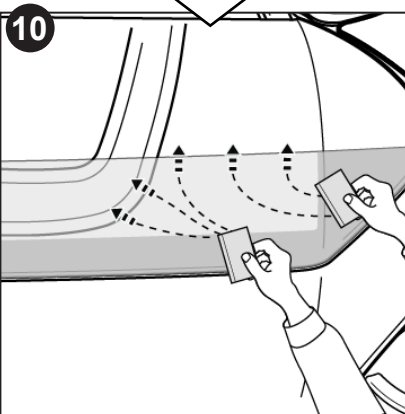
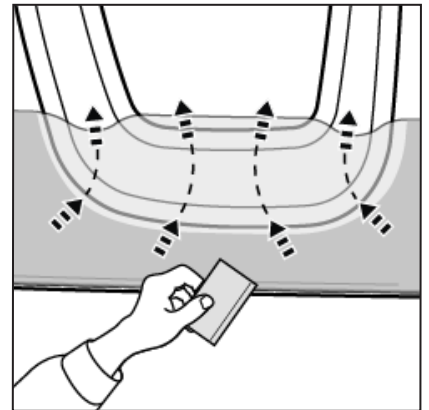
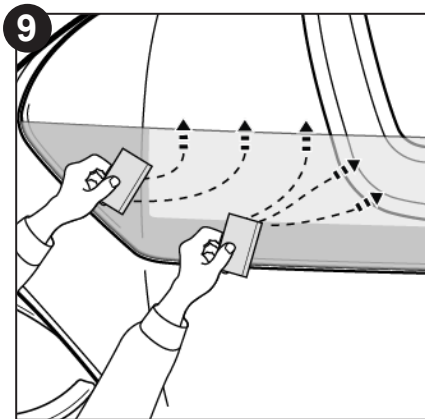
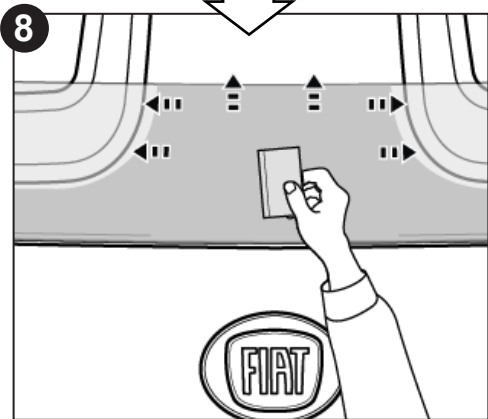
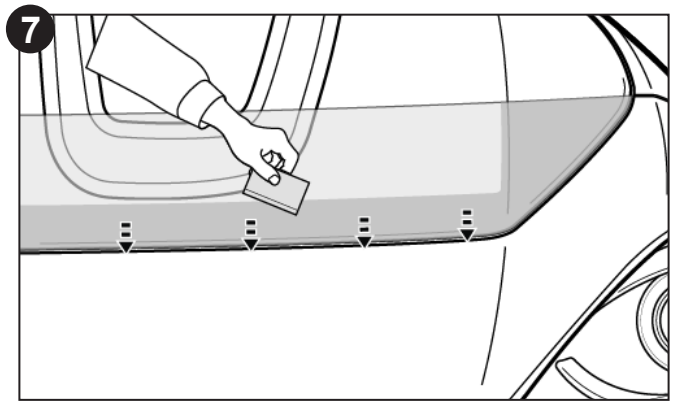
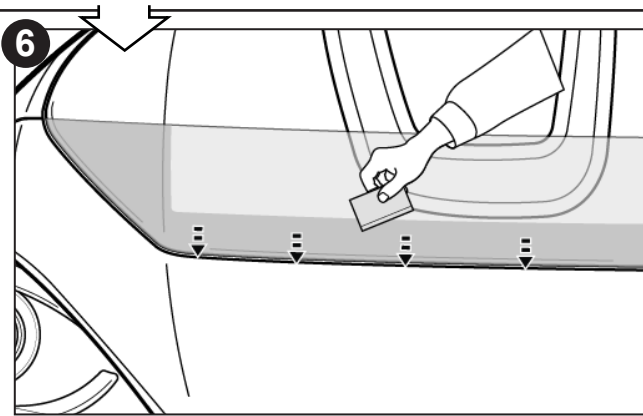
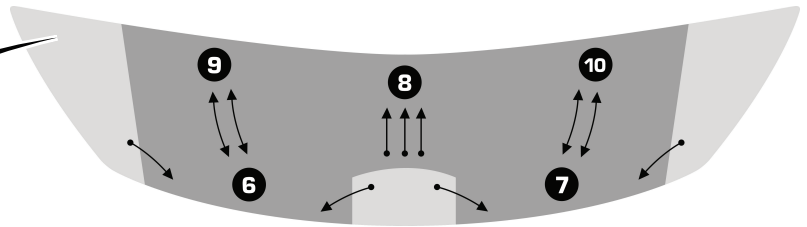
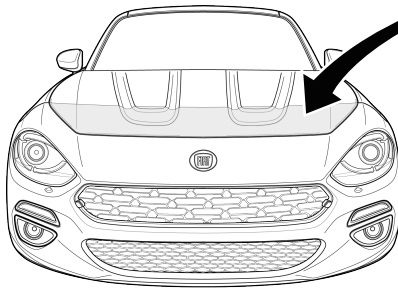

2



3-4

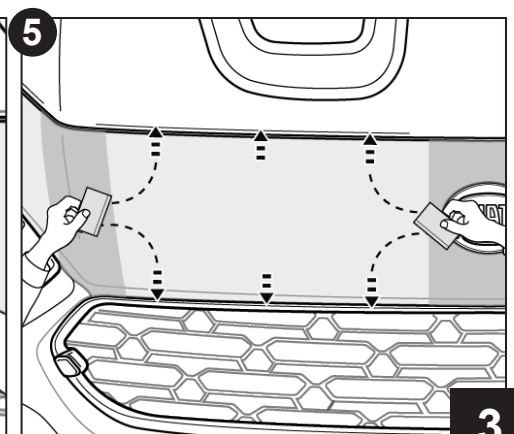
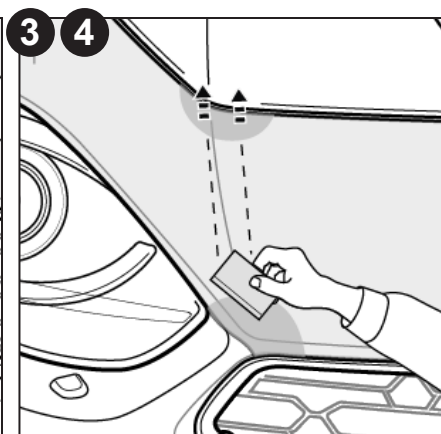
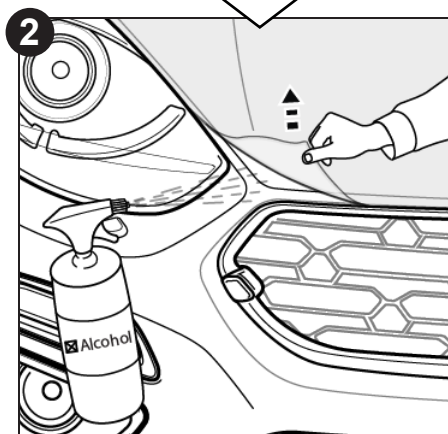
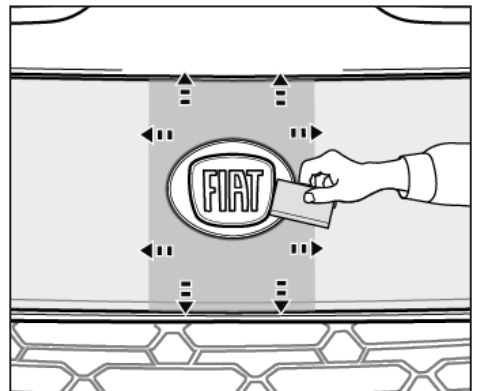
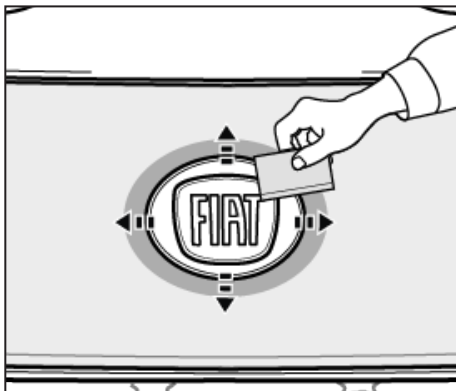
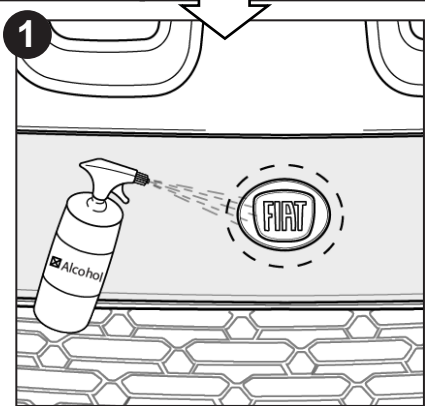
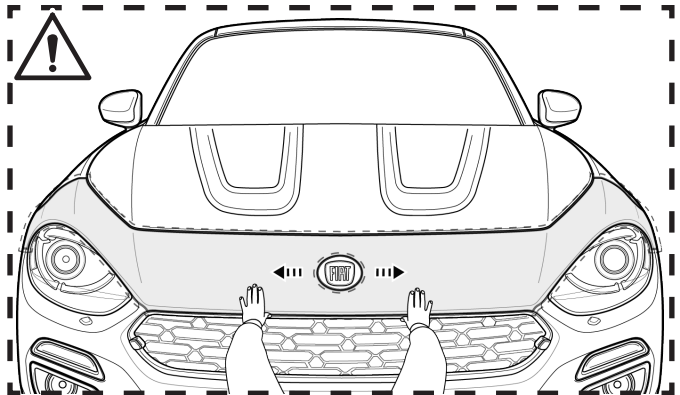
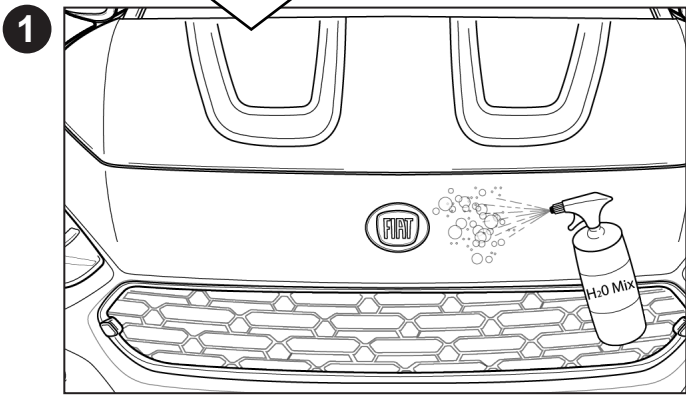
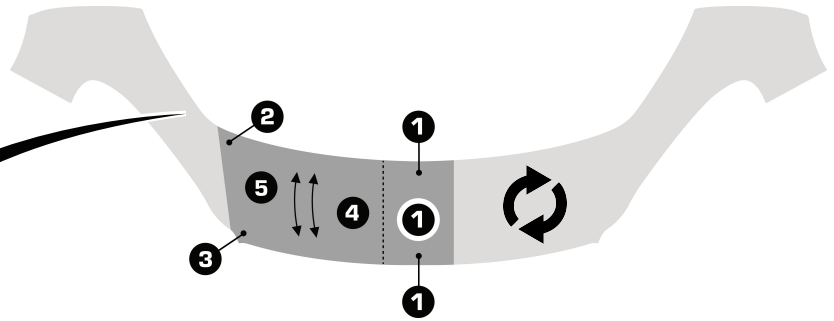
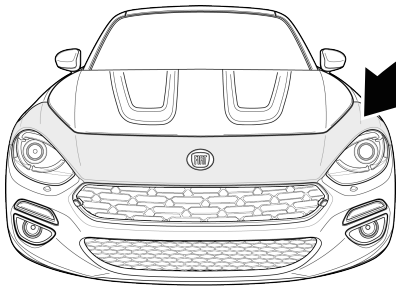

3



3-4

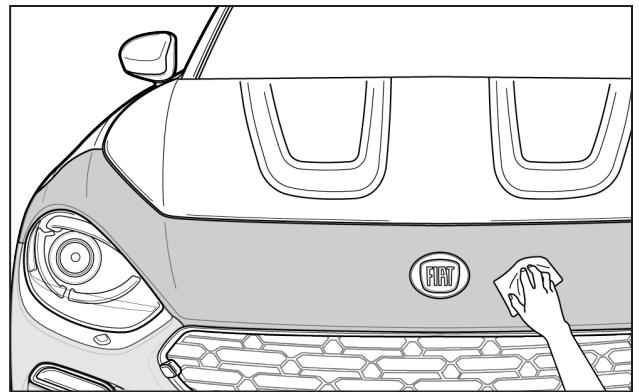
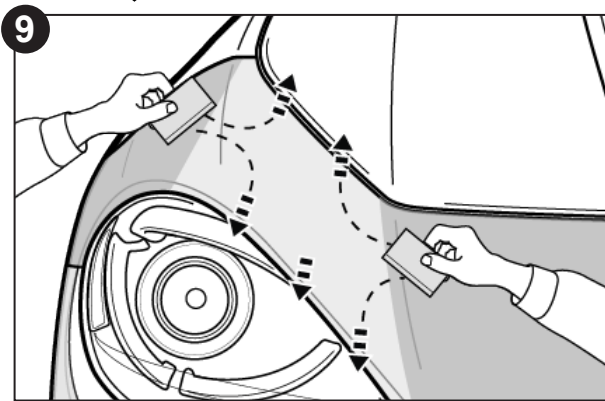
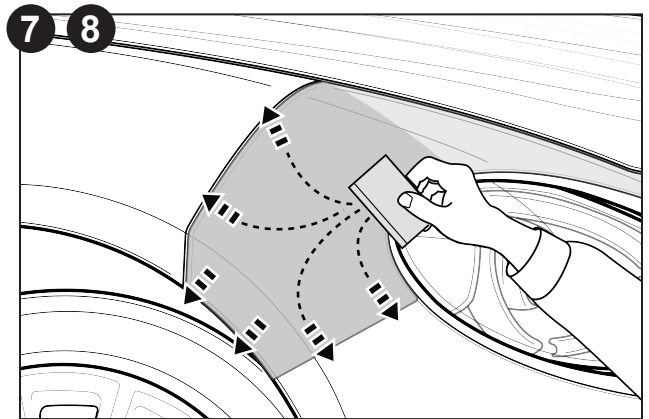
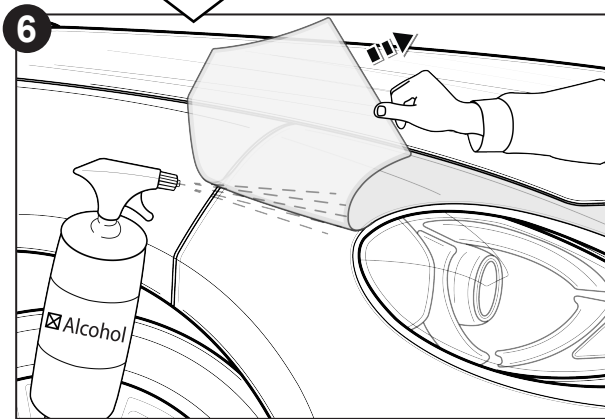
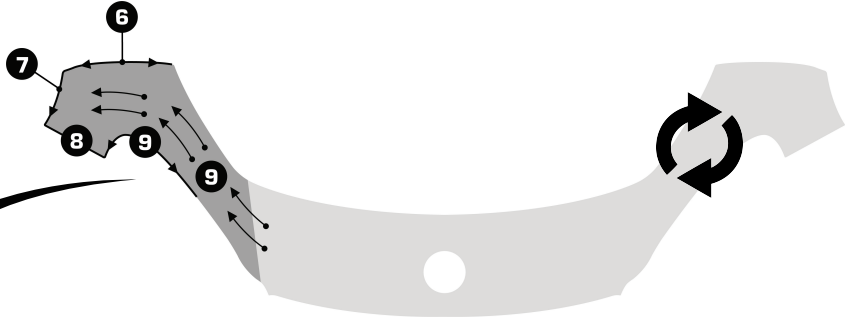
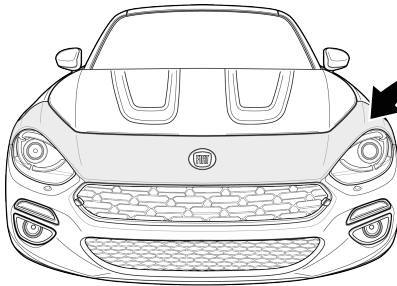

5 - 7 x2

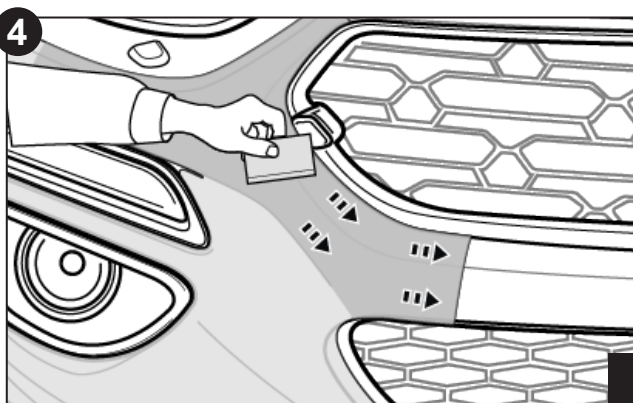
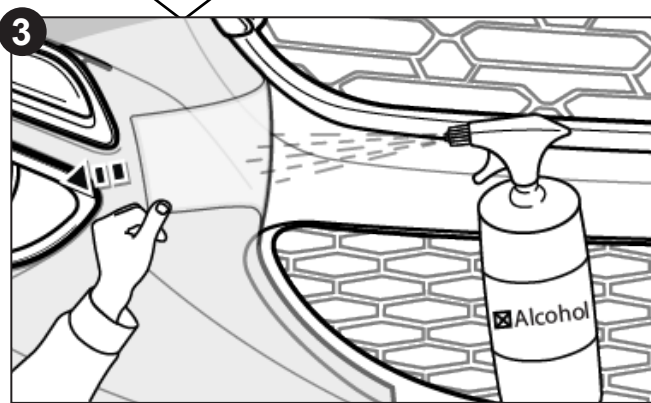
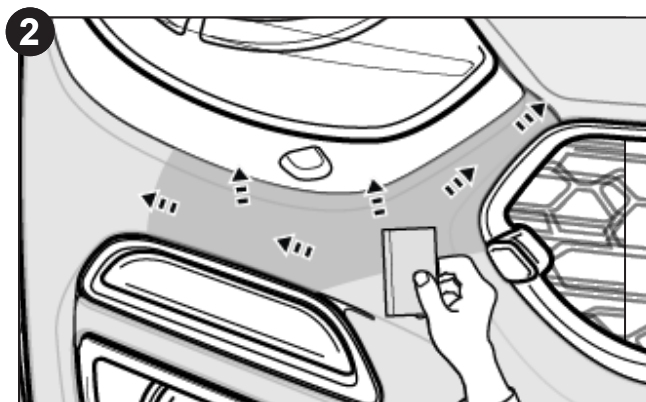
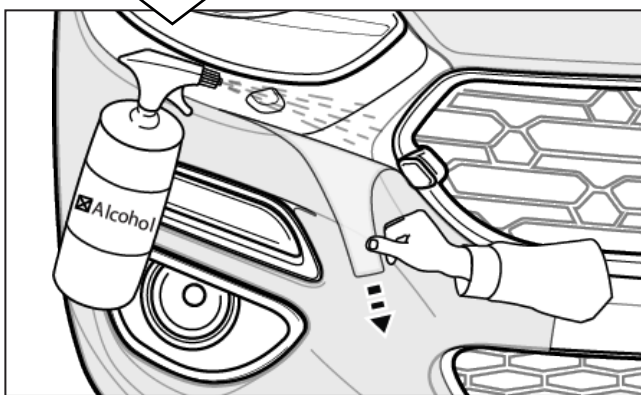
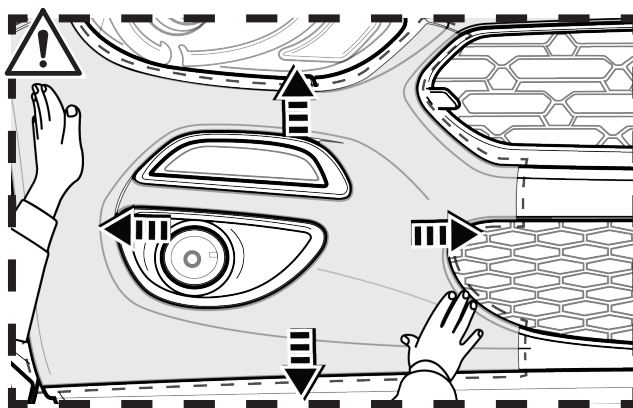
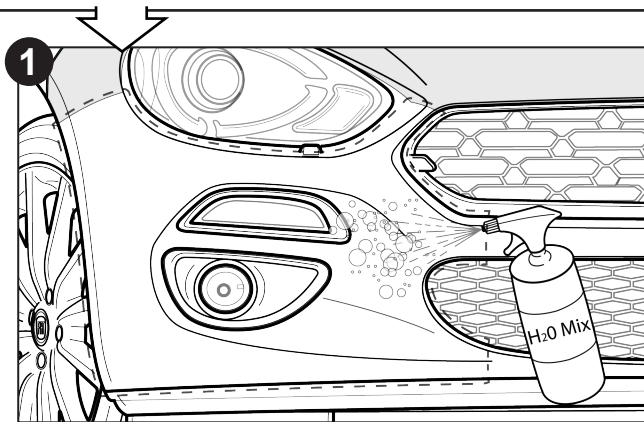
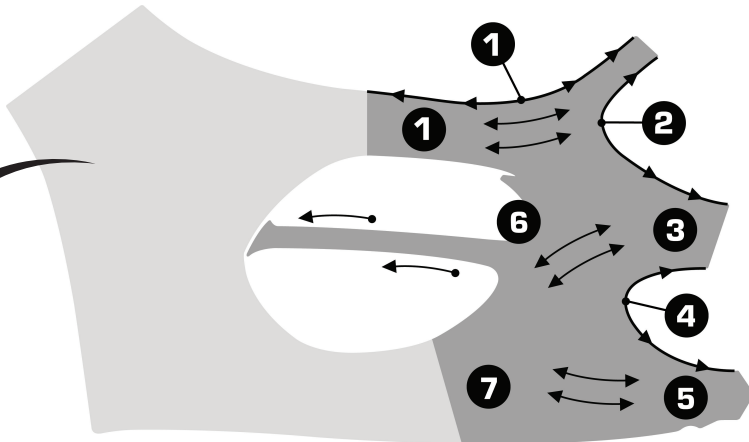
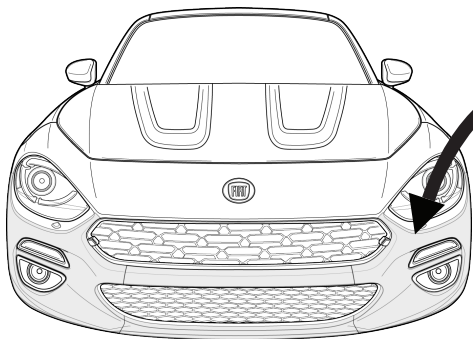



5-7

x2

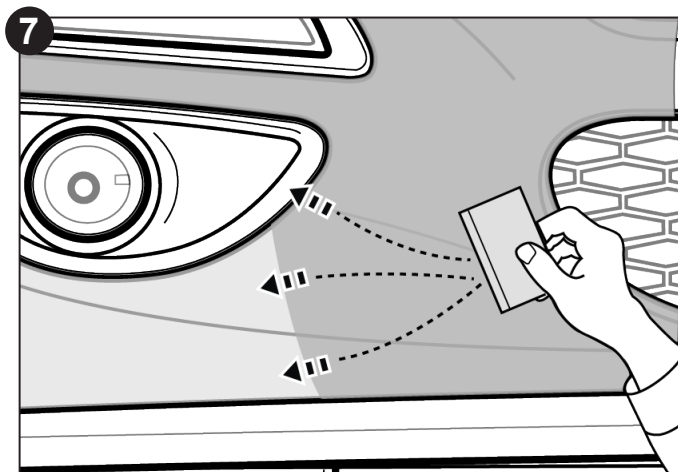
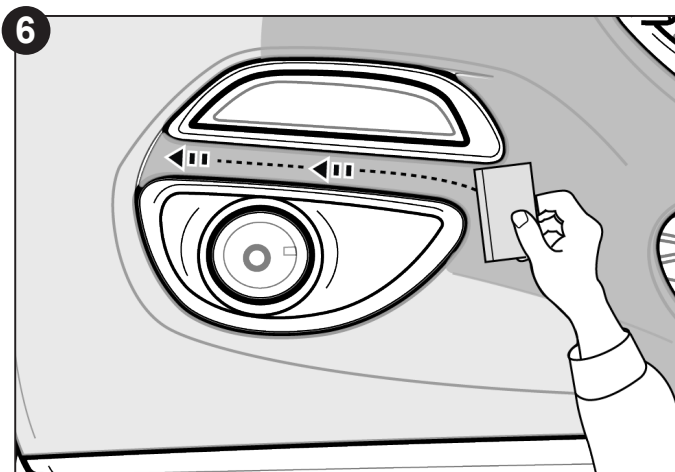
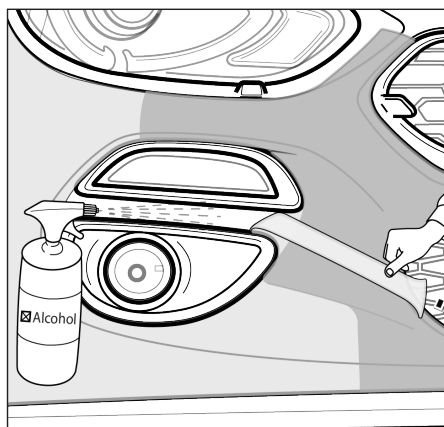
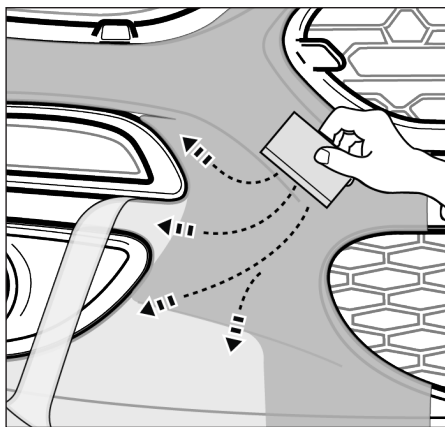
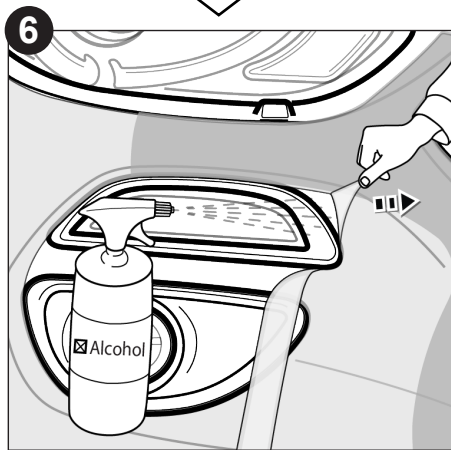
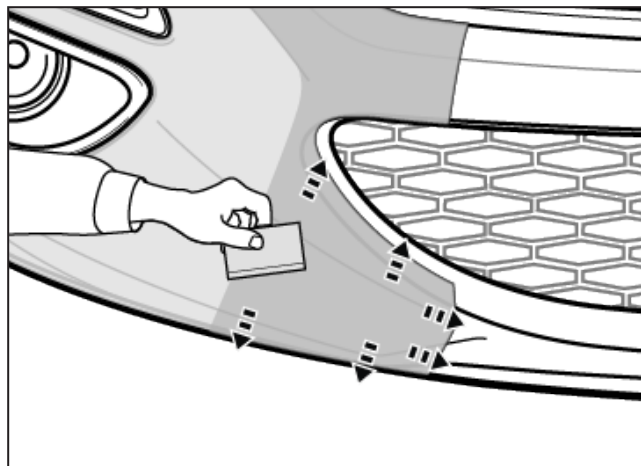
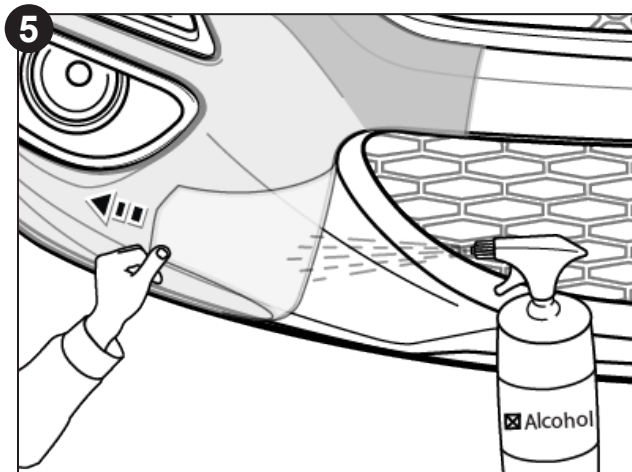

 **5 - 7** **x2**

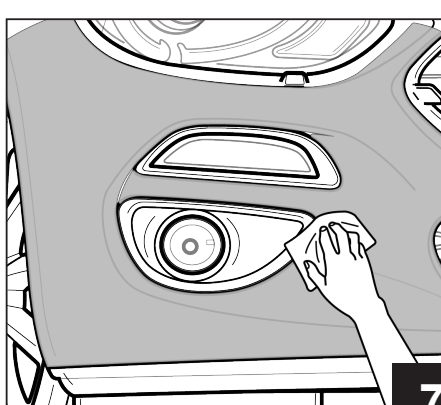
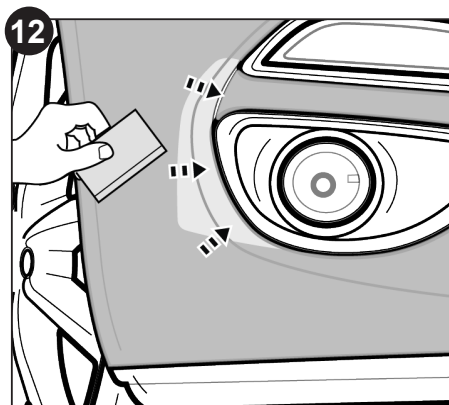
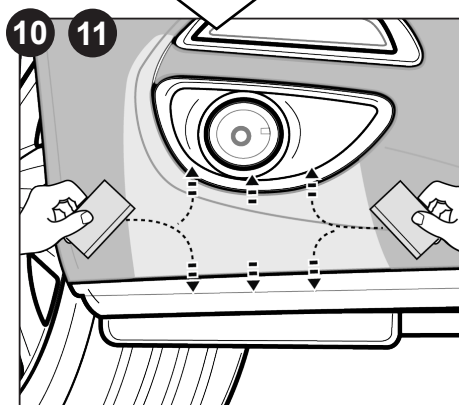
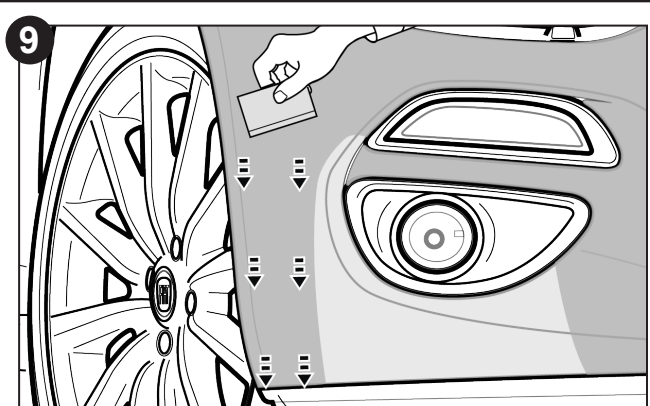
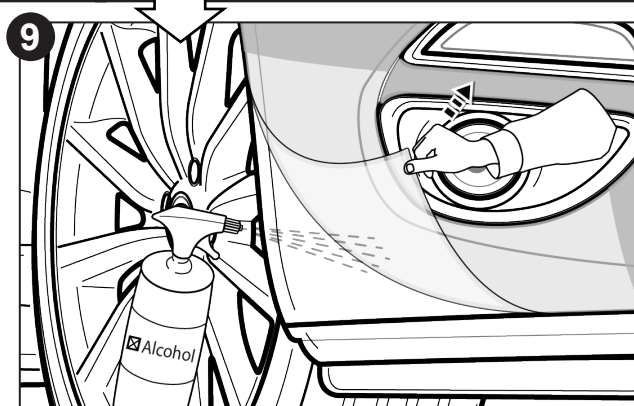
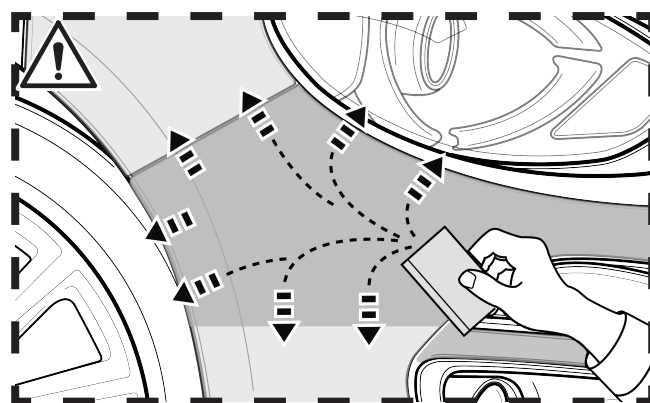
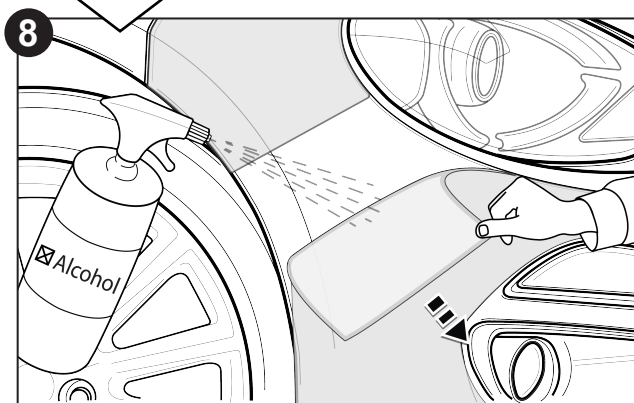
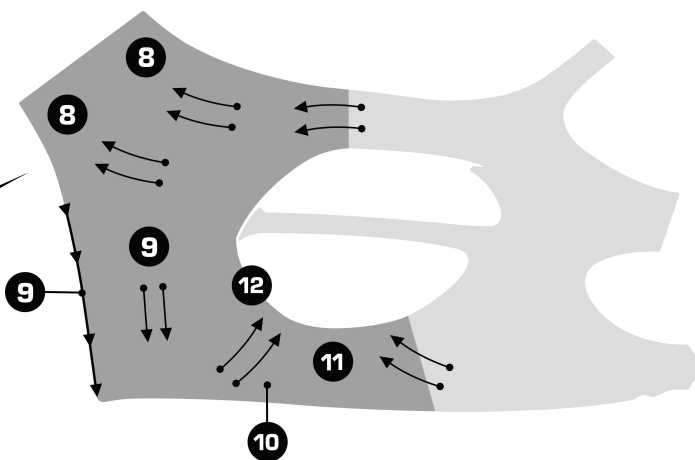
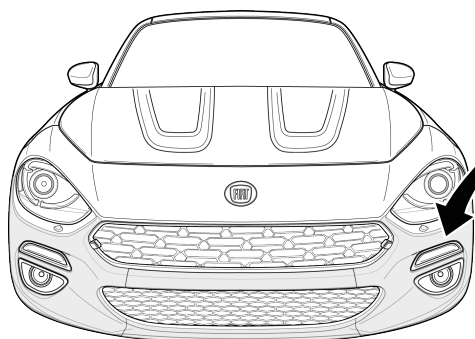



8 - 9

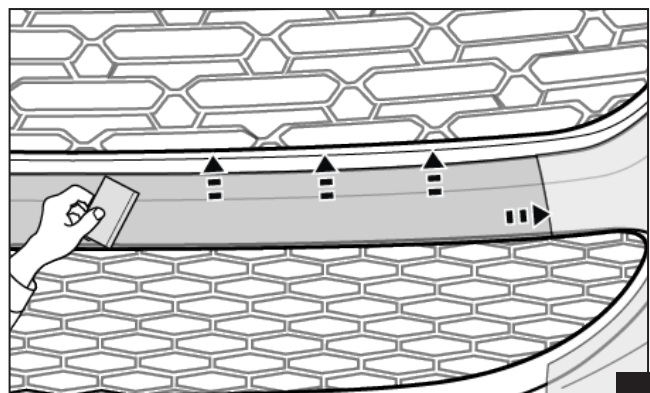
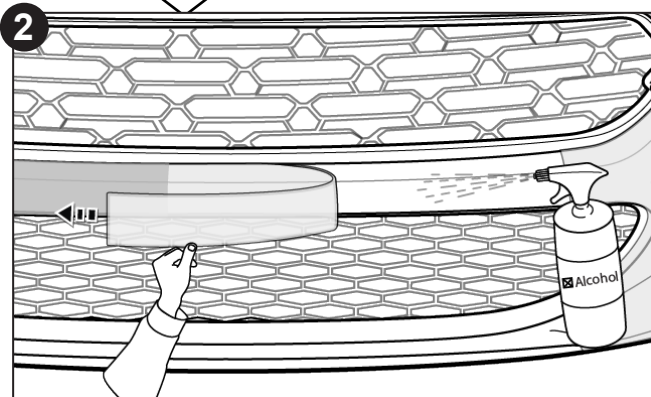
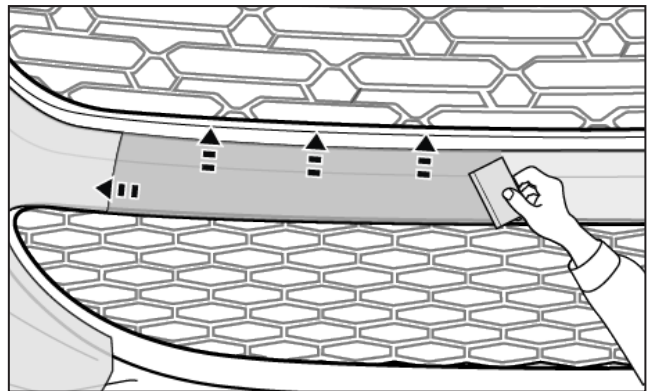
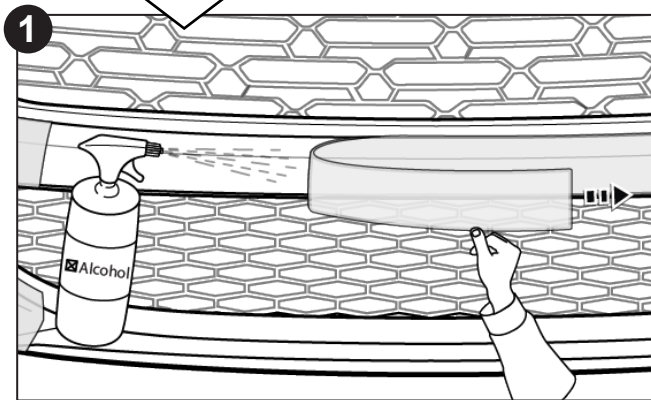
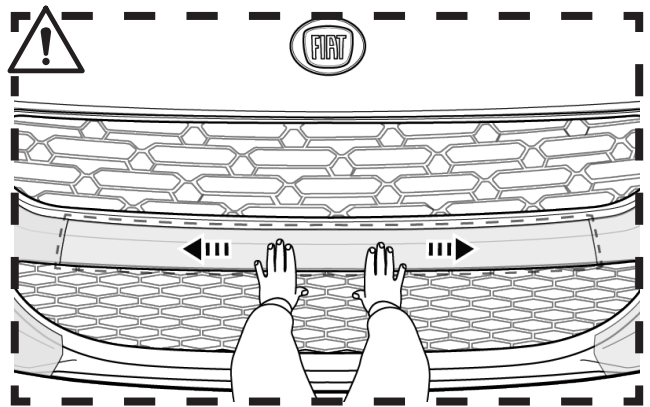
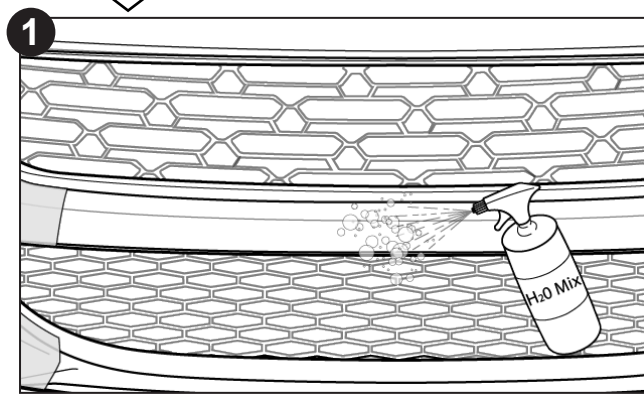
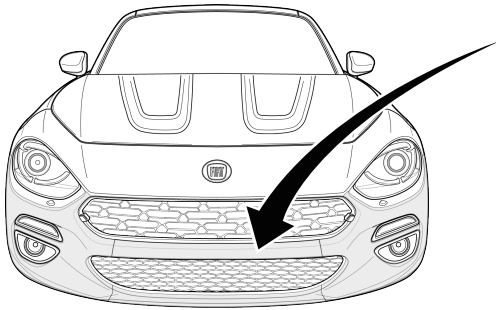

8



8 - 9

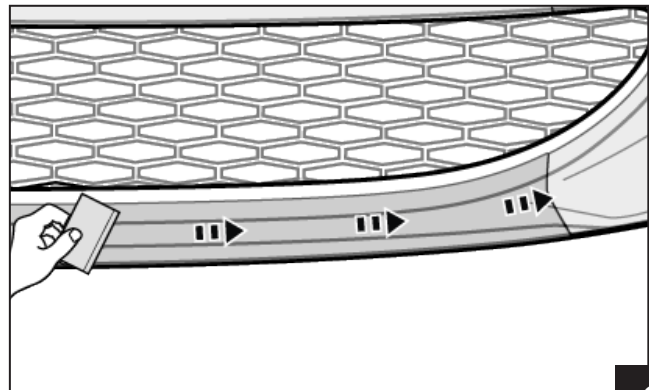
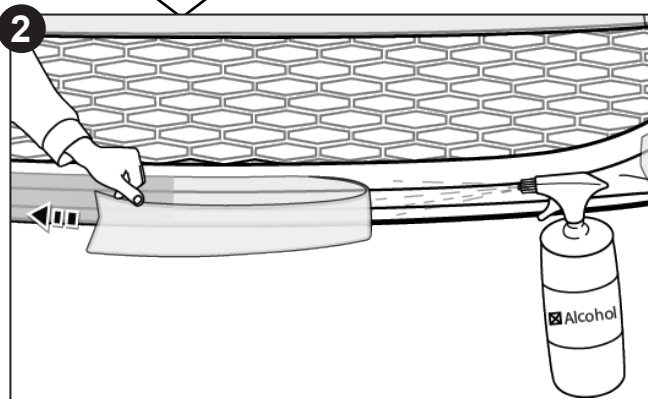
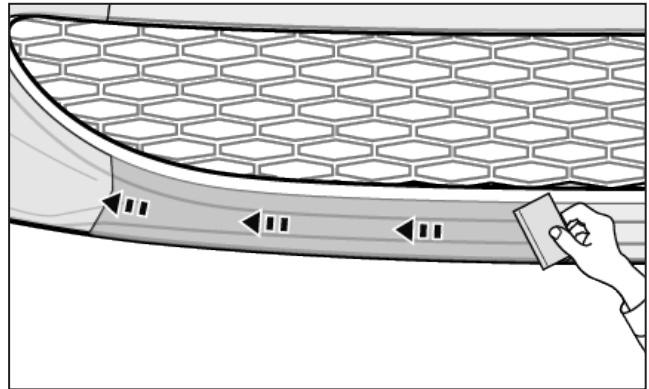
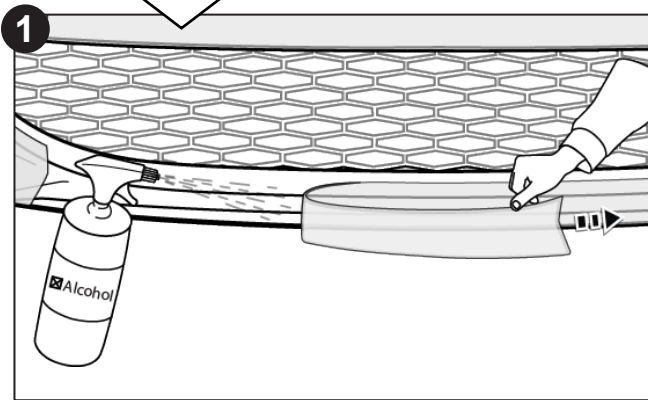
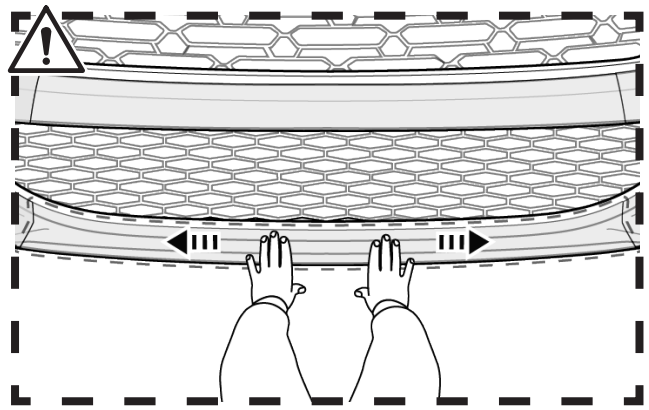
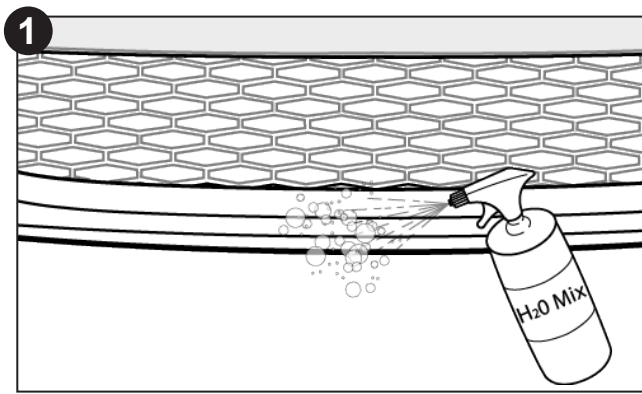
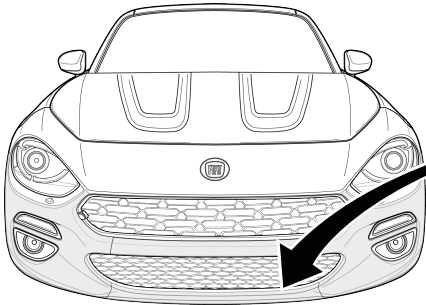

9



10-11

x2

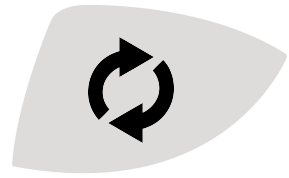
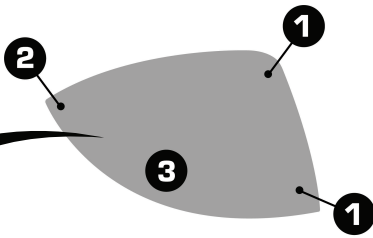
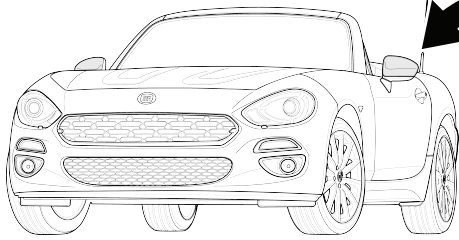

1

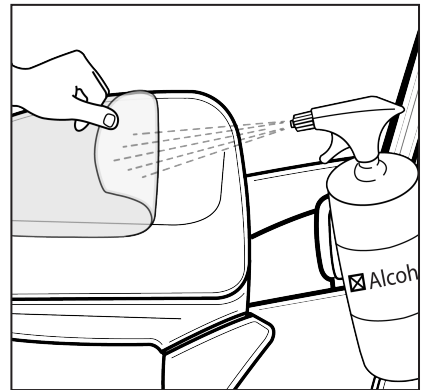
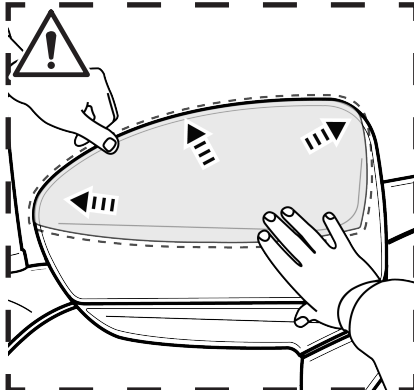

1

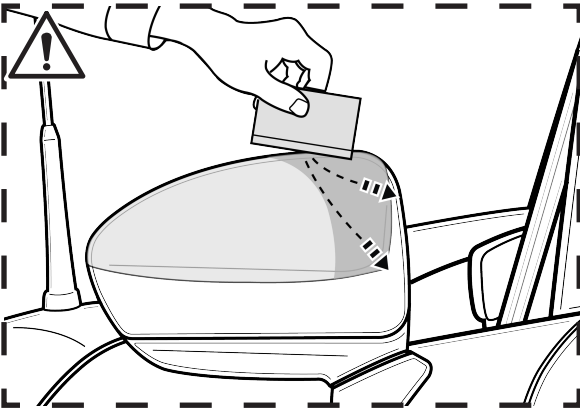

2

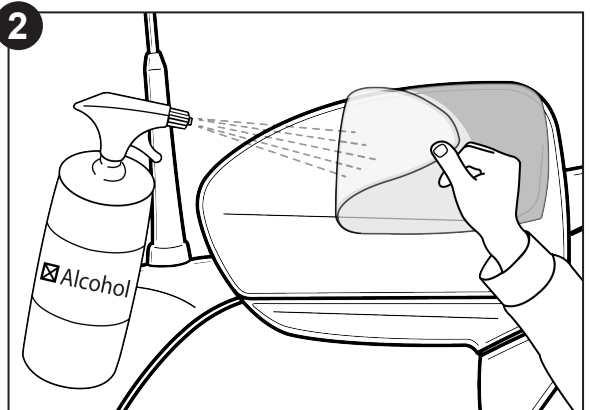

2

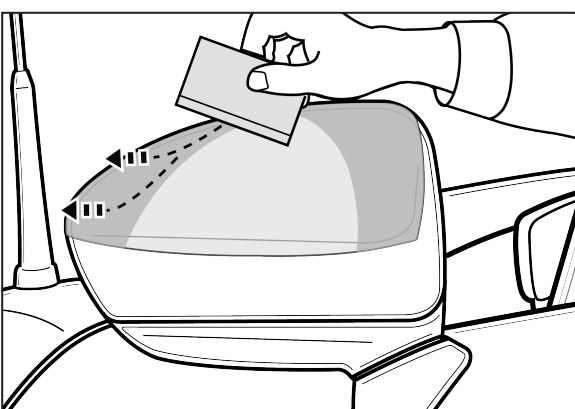

3

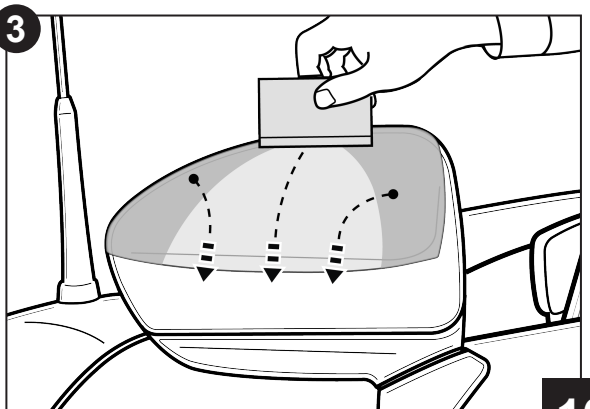

10



10-11

x2

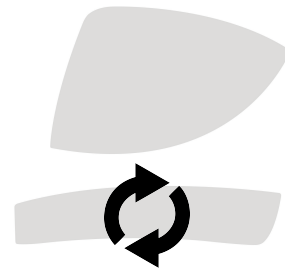
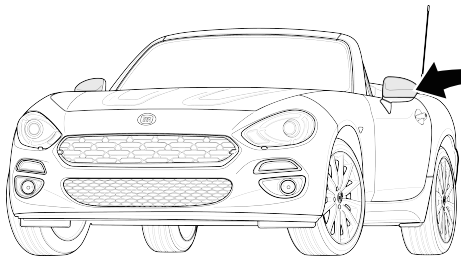

1

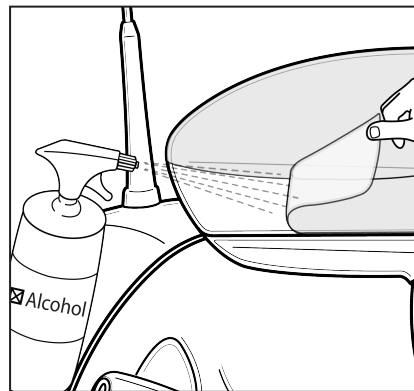
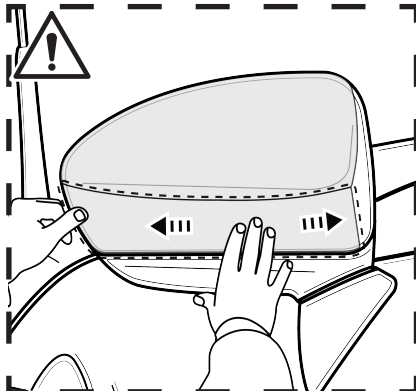
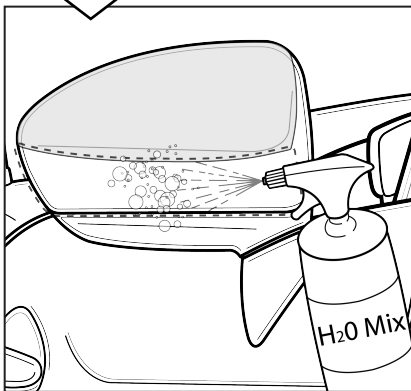

2

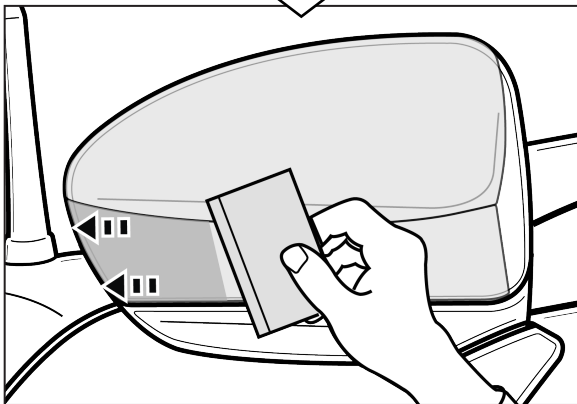

3

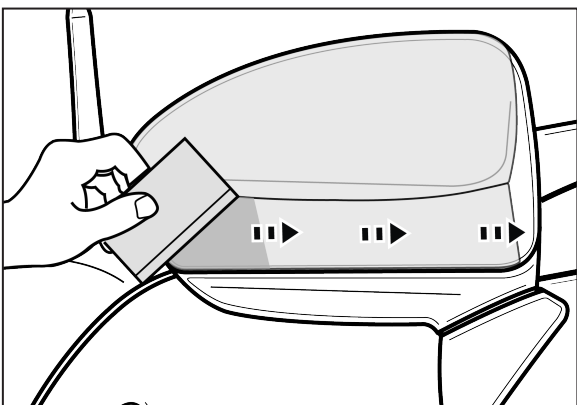
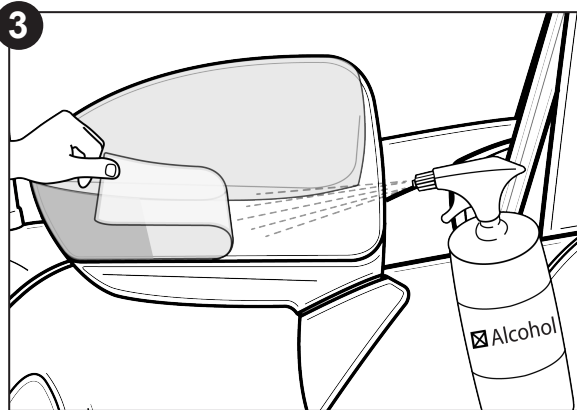

4

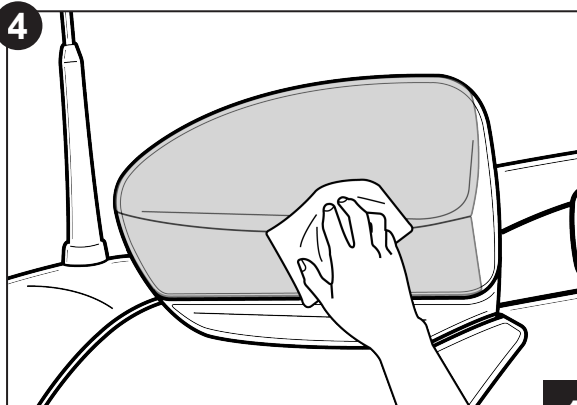

11



12

x2

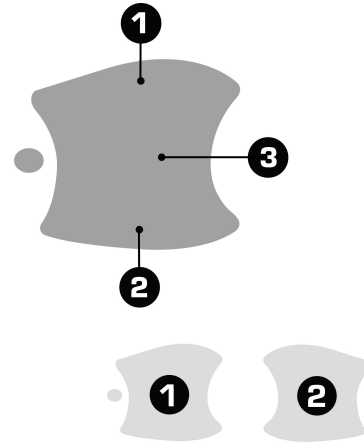
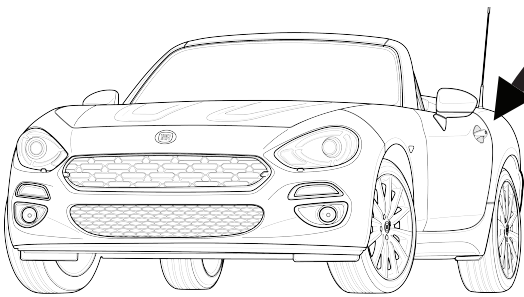

1

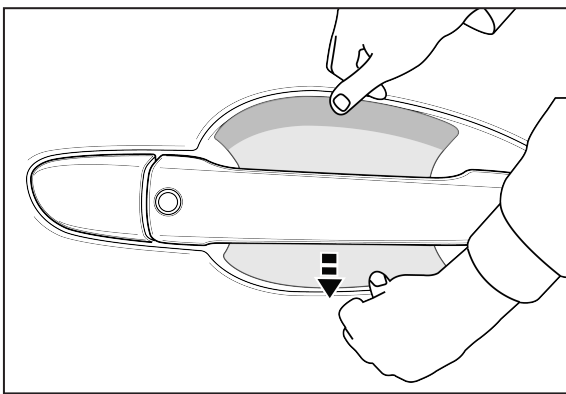
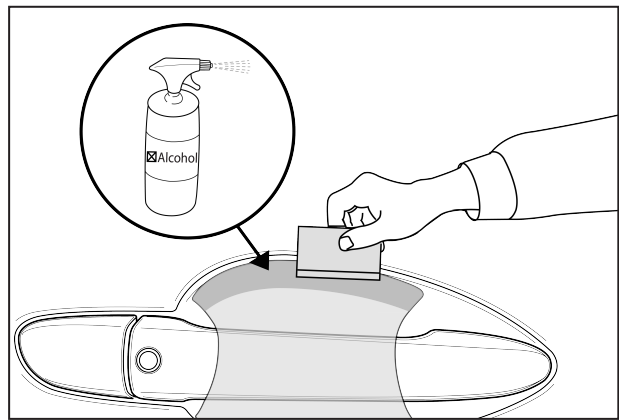
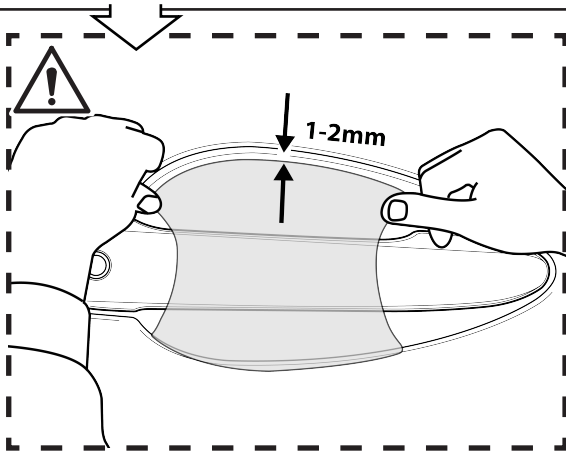

2

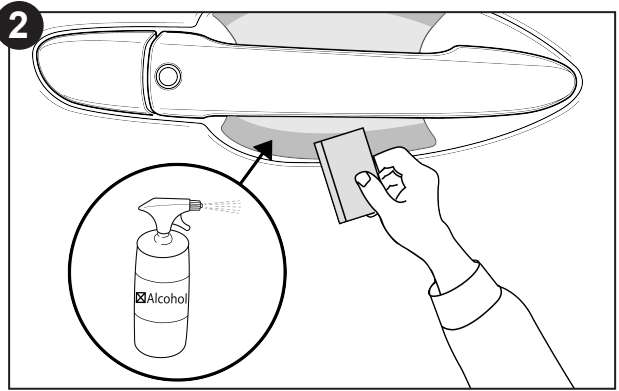

3

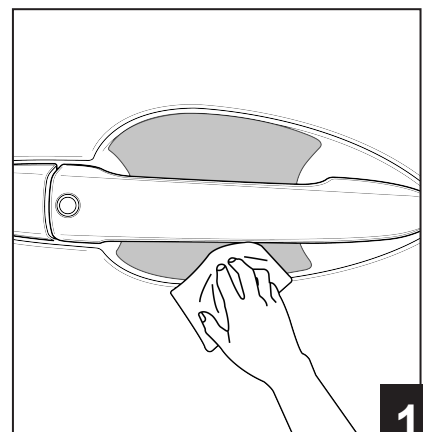
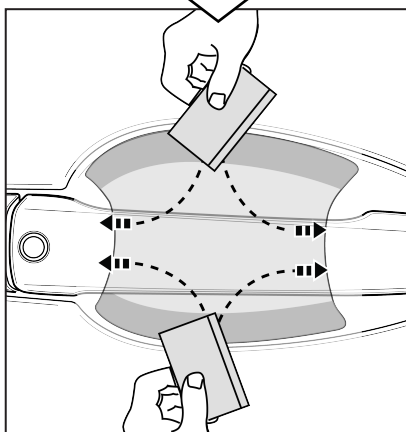
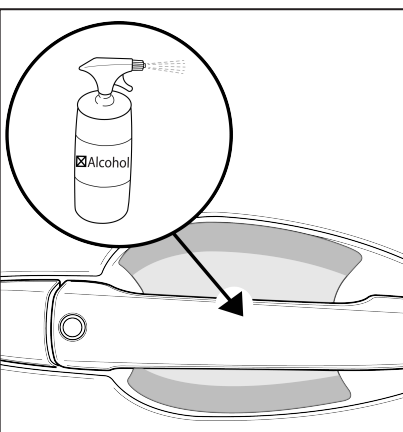

12