

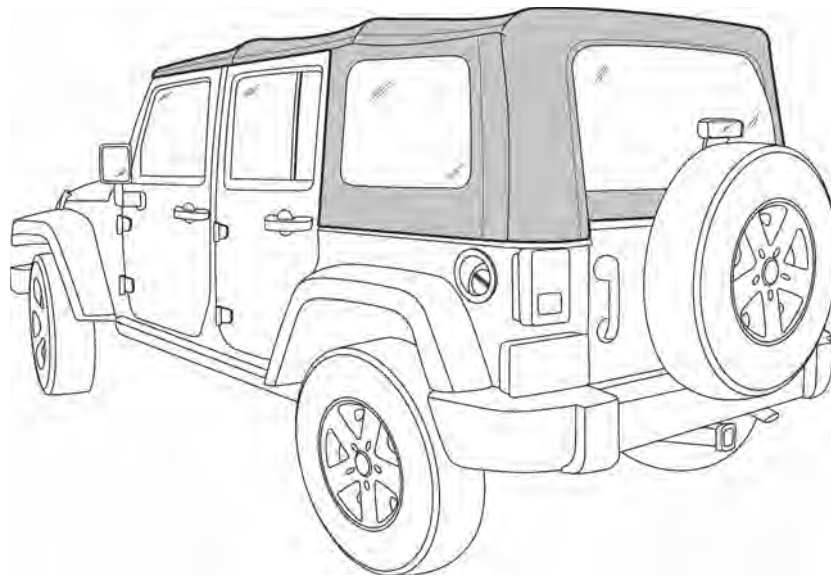

JEEP WRANGLER

4 Door Top Kit



82212264
82212265



A 1X

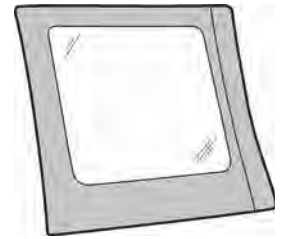

B 1X

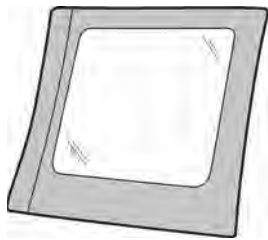

C 1X

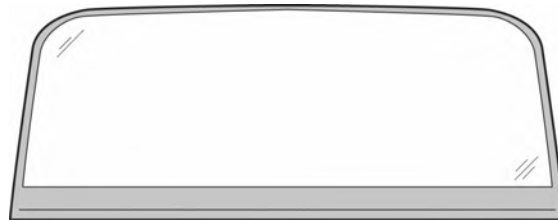

D 1X



E 1X

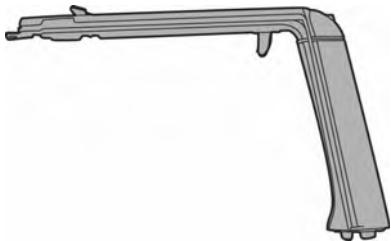

F 1X



G 1X

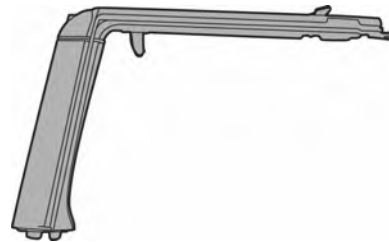

H 1X

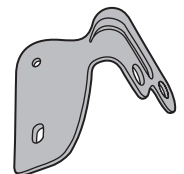

I 1X

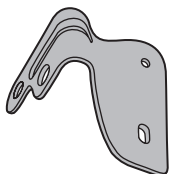

J 1X

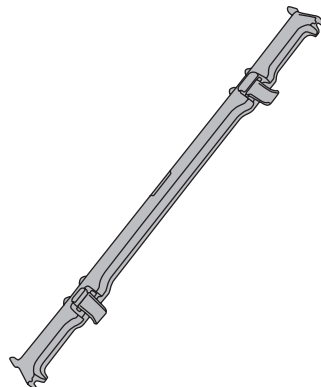



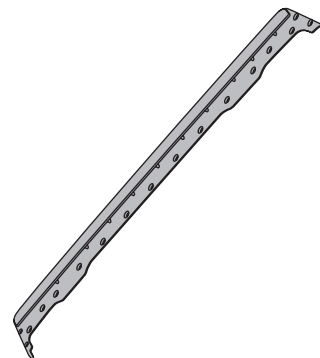



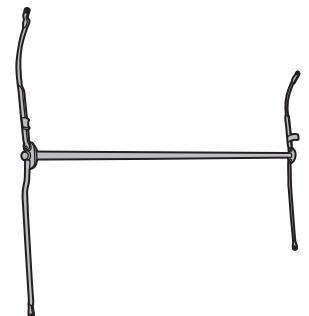

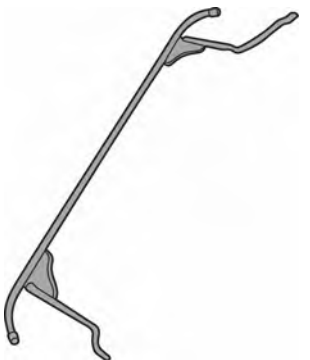
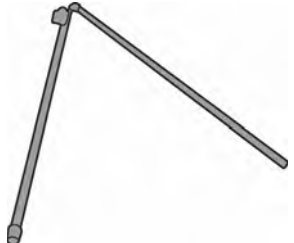

K 1X

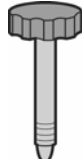

L 1X

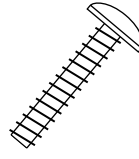
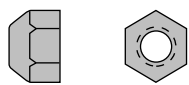
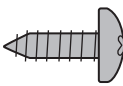
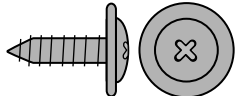
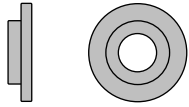
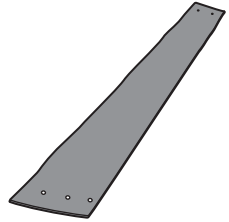
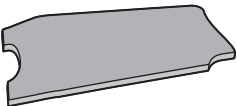
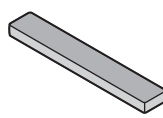

M 1X

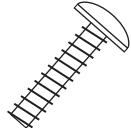
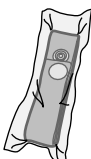
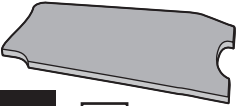
| | | | | |
|---|--|--|--|---|
|  <p>N 1X</p> |  <p>O 1X</p> |  <p>P 1X</p> |  <p>Q 1X</p> | |
|  <p>R 1X</p> |  <p>S 1X</p> |  <p>T 1X</p> |  <p>U 4X</p> | |
|  <p>V 2X</p> |  <p>W 4X</p> |  <p>X 6X</p> |  <p>Y 2X M5 x 30 mm</p> | |
|  <p>Z 4X</p> |  <p>AA 27X</p> |  <p>BB 27X</p> |  <p>CC 8X</p> |  <p>DD 2X</p> |
|  <p>EE 1X</p> |  <p>GG 2X</p> |  <p>HH 4X</p> |  <p>JJ 2X M5 x 16 mm</p> |  <p>KK Roll Up Straps (2 Elastic / 2 Web)</p> |
|  <p>FF 1X</p> | | | | |

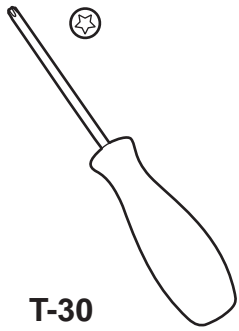

**T-30
Torx**

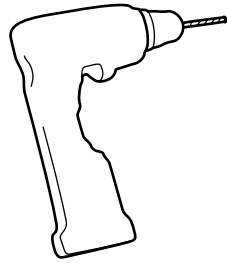

**Drill
#2 Phillips Bit**

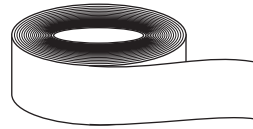

Masking Tape

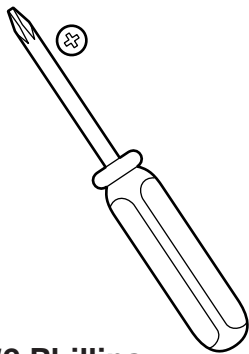
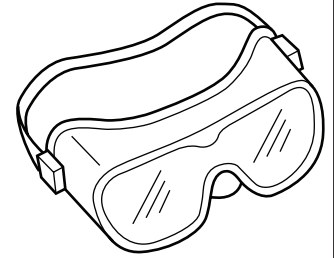

**#2 Phillips
Screwdriver**

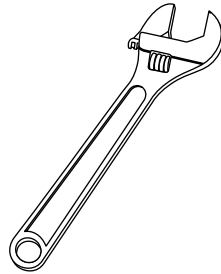

**Adjustable
Wrench**



Pliers

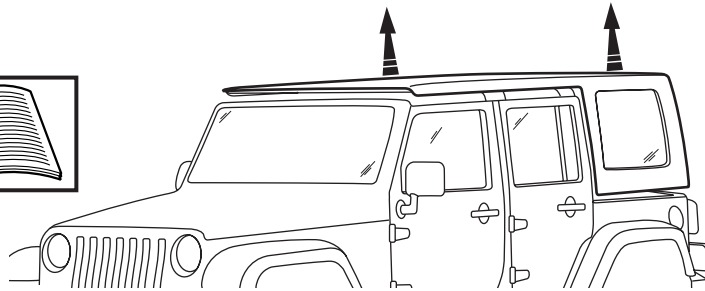

**Remove the hard top.
Refer to owner's manual
for instructions.**

1

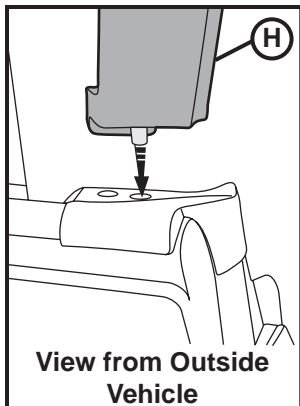

**View from Outside
Vehicle**

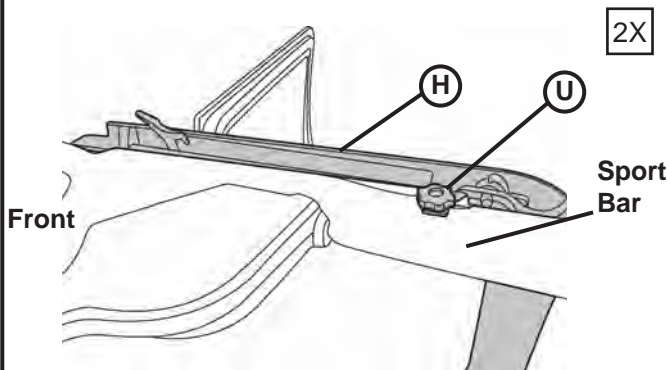

Front

Sport
Bar

View from Inside Vehicle

Passenger Side Shown

**Locate the left and right
Rear Door Surrounds.
Insert the pin in the bot-
tom of the Door Sur-
round into the hole in
the belt rail behind the
door.**

**Place a Long Knob
through the tab on the
Door Surround and
tighten.**

2

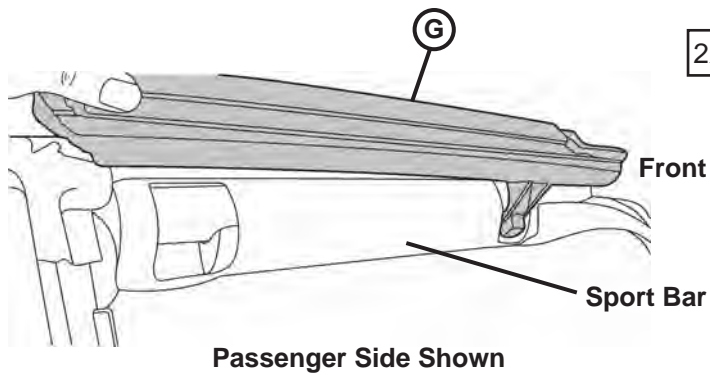

2X

Place the Front Door Rail above the door opening.

3

Passenger Side Shown

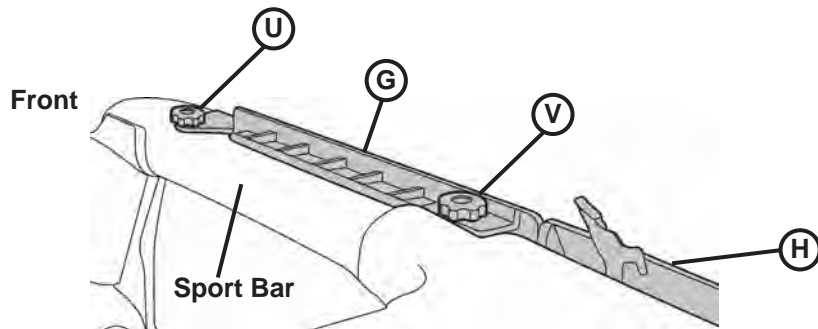

2X

Install a Long Knob at the front of the rail and a Short Knob in the center.

4

View from Inside Vehicle
Passenger Side Shown

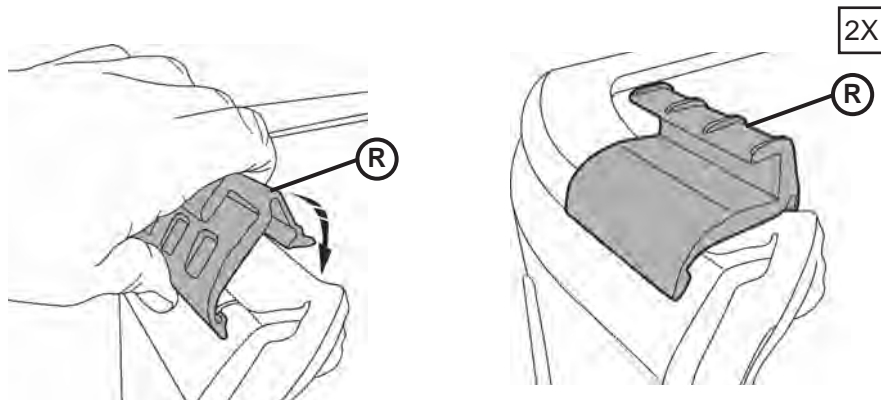

2X

Locate the left and right Tailgate Mounts. Orient them on the vehicle. Hook the bottom of one mount under the belt rail and roll it toward the inside of the vehicle until it clips into place. Repeat this with the other Tailgate Mount.

5

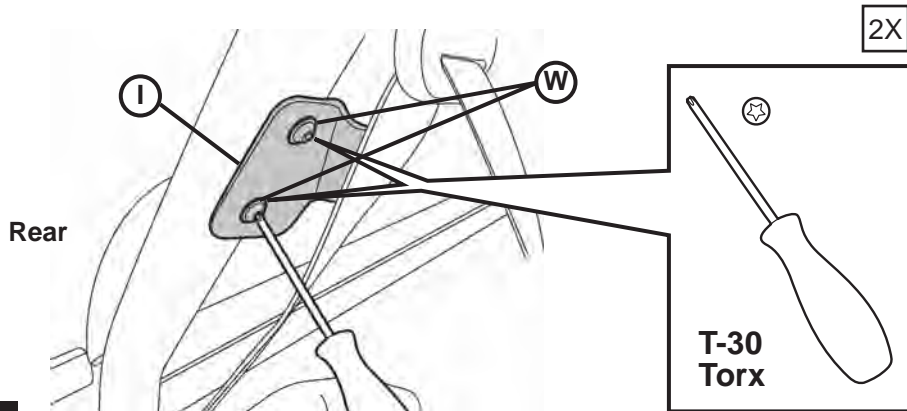

2X

Use Bracket Screws to install Bow Mount Brackets on rear sport bar.

6

Driver's Side Shown

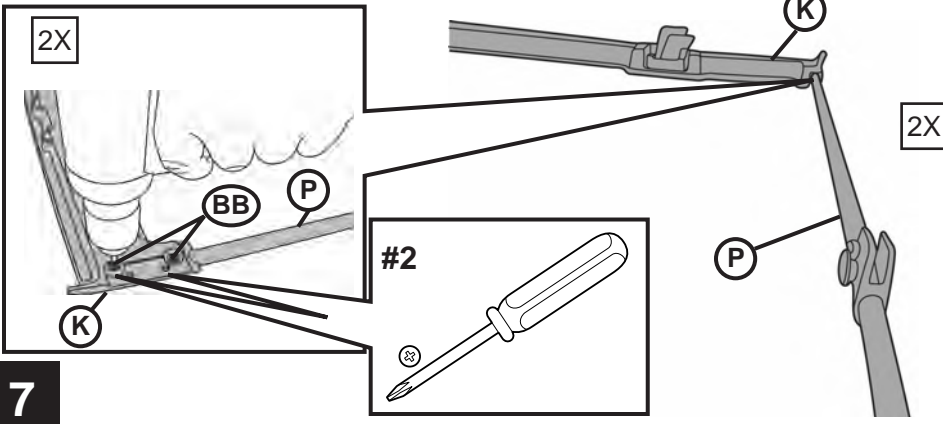

Place the Lower Header on the Side Bows. Orient the Side Bows with the Brackets up. Install two (2) #8 x 1/2" Pan Head Washer Screws to secure the Lower Header to each Side Bow.

7

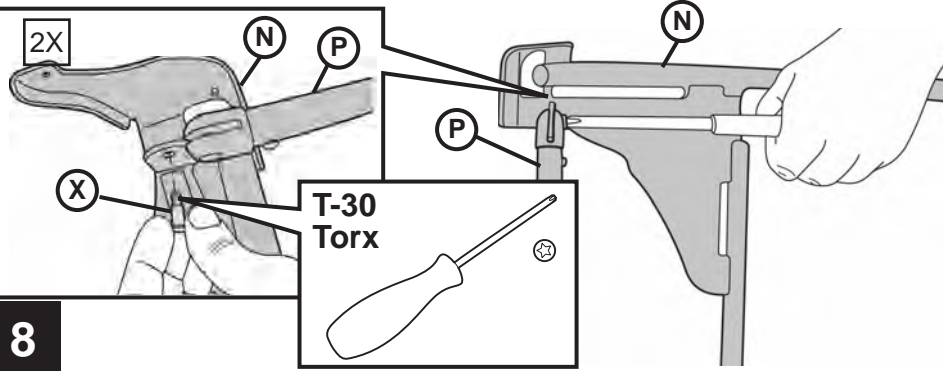

Use a Pivot Knuckle Bolt to install the #3 Bow to the Side Bow/Header Assembly.

8

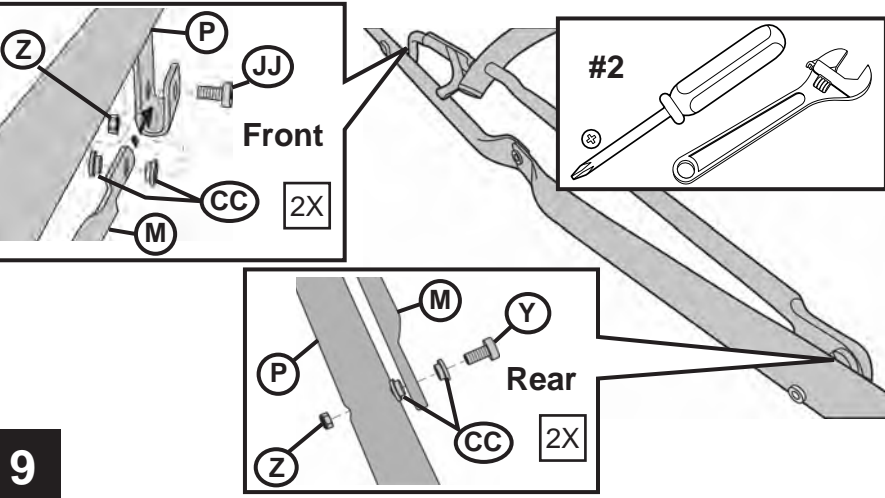

Locate the #2 Bow Assembly. Place it on the Side Bow/Header Assembly.
 Front: Install an M5 x 16 Machine Screw with two (2) Bushings and an M5 Nylock Nut on the front of the Side Bow.
 Rear: At the rear install an M5 x 30 Machine Screw with (2) Bushings and an M5 Nylock Nut.
 Repeat these steps on both legs of the #2 Bow

9

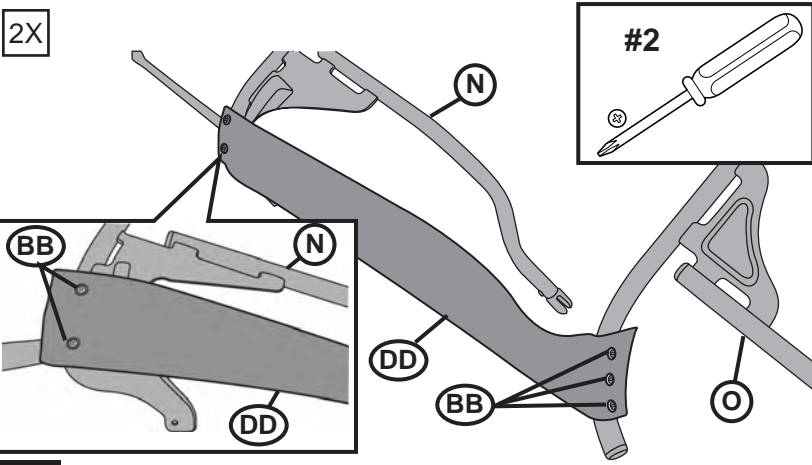

CAUTION
 Do Not allow Stay Pad to twist.
 Align the two (2) holes in the square end of the Stay Pad with the 2 holes in the corners of the #3 Bow. Install two (2) #8 x 1/2" Pan Head Washer Screws. Pull the pointed end of the Stay Pad back to the #4 Bow. Make sure that it is not twisted and the point is to the inside. Install three (3) #8 x 1/2" Pan Head Washer Screws. Repeat on both sides.

10

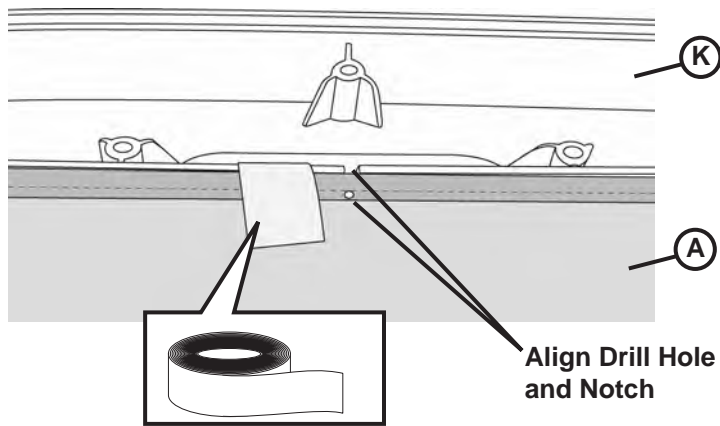

CAUTION

Drill Hole in fabric and notch in Lower Header must be aligned.

Lay the front edge of the top fabric on the Lower Header with the backing side up. Make sure the drill hole in the center of the fabric lines up with the notch in the Lower Header. Tape the fabric in place.

11

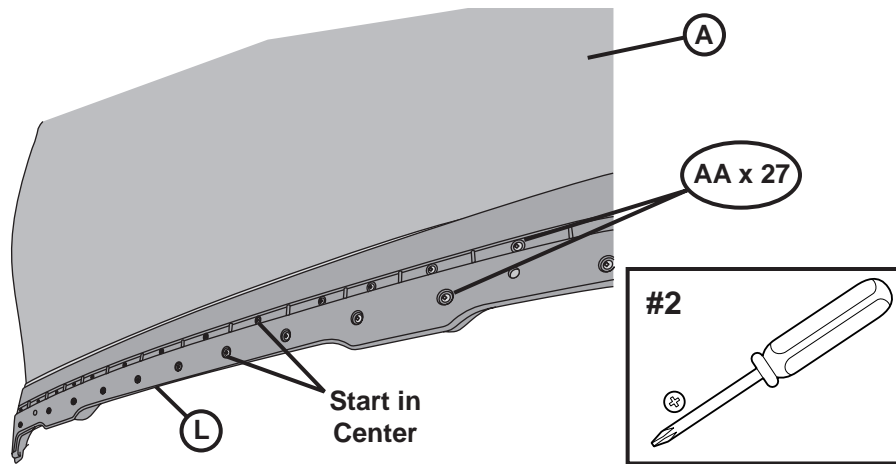

Lay the Upper Header on top so that the fabric is sandwiched between the Upper and Lower Headers. Start with the center hole and install twenty-seven (27) #8 x 1/2" Phillips Truss Head Screws.

12

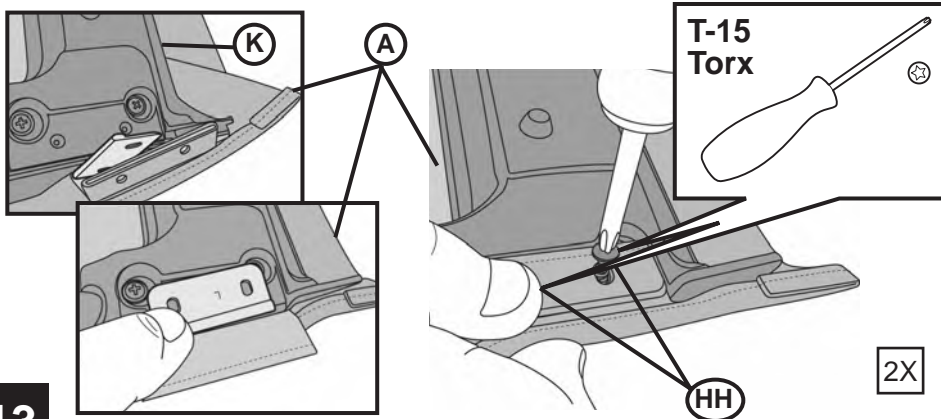

Wrap the fabric around the edge of the header. Slip the fabric pocket sewn into the top between the headers and position the anchor foot. Install two (2) #8 x 1/2" Hi-Lo Thread Screws through the fabric and metal flag into the Lower Header on each side.

13

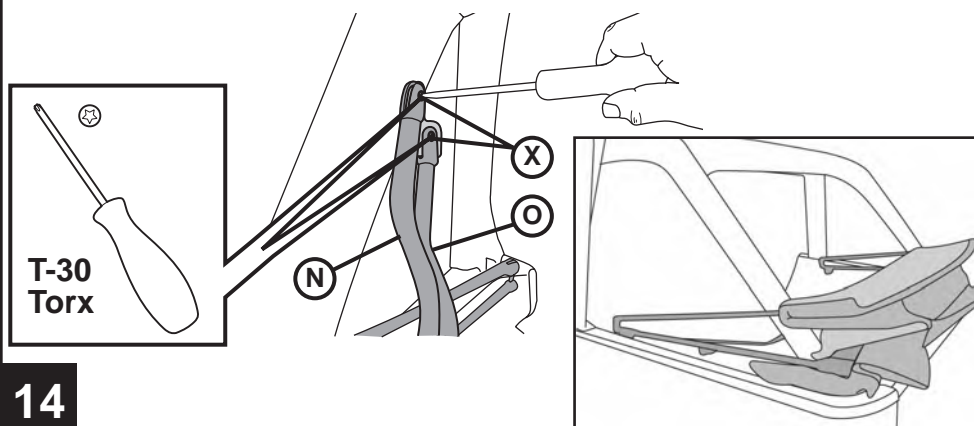

Place the Top Assembly on the vehicle. Use Pivot Knuckle Bolts to mount rear bow on Top Assembly to Bow Mount Brackets.

14

2X

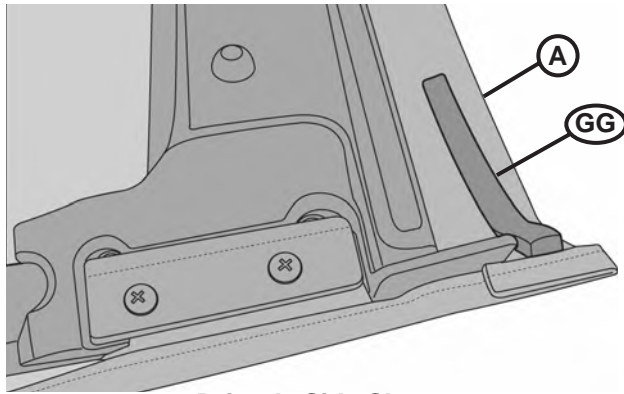

Driver's Side Shown

Install Fabric Foam on Header.

15

EE
(Passenger
Side FF)

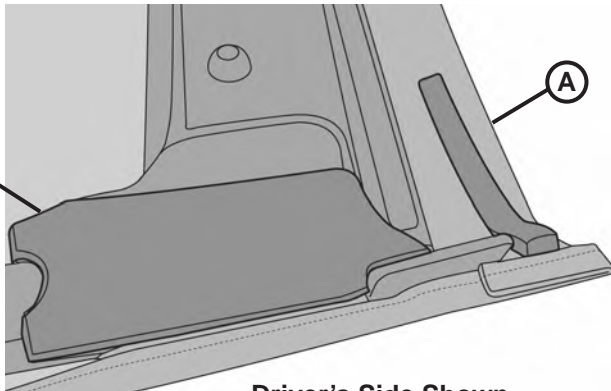

Driver's Side Shown

Install Header Foam on Header.

16



Open the Top Assembly and drape it over the cab of the vehicle.

17

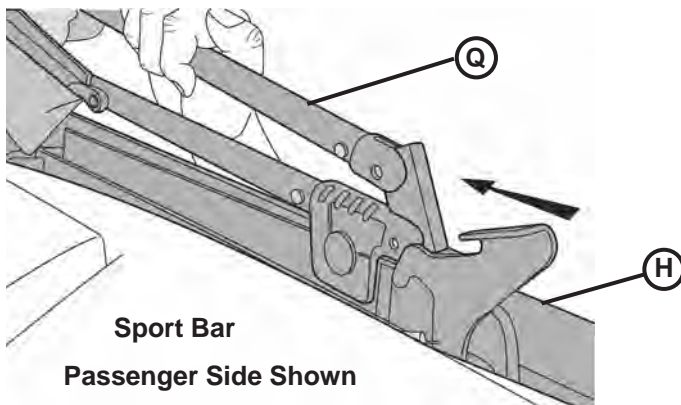

Sport Bar
Passenger Side Shown

Slide the Pivot Assembly on the Top along the track above the door until it latches into place.

18



Pull the fabric up over the bow assembly.

19

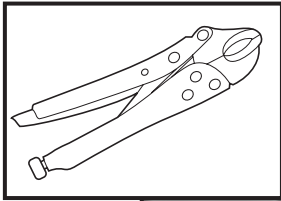

2X

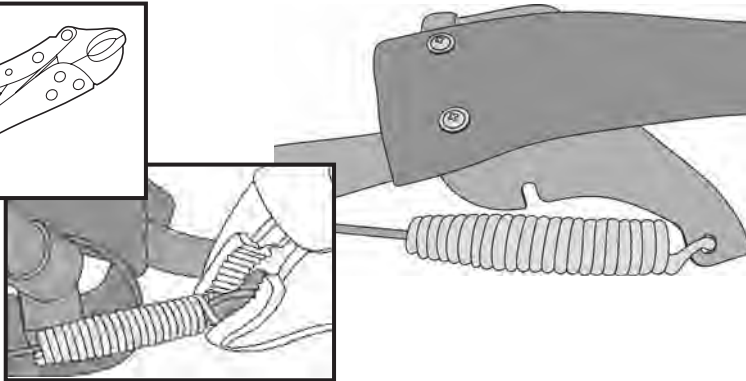

Secure Cable Spring to bracket on bow and crimp spring.

20

Hook Latch to Windshield

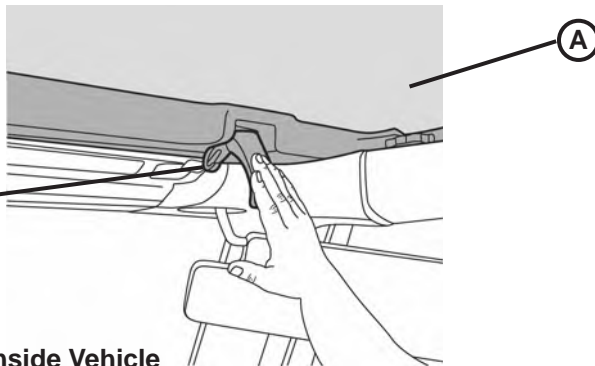

View from Inside Vehicle

Close the front of the Top and secure the latches on the header to the windshield.

21

BB

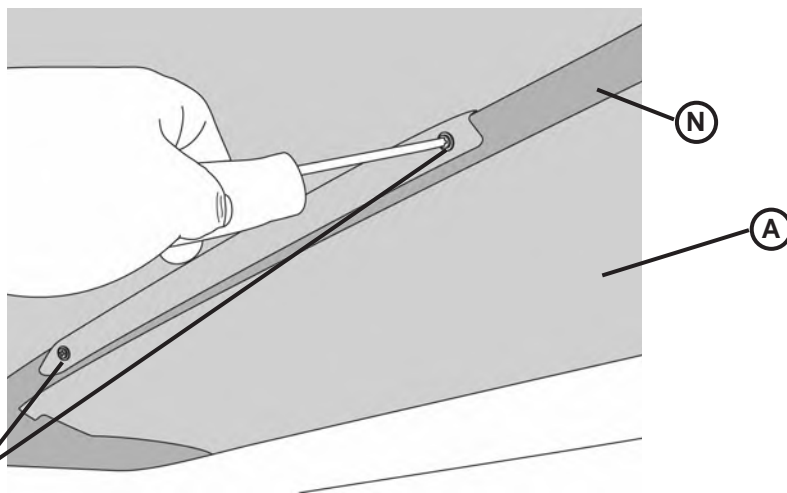

Once the top is in place, locate the flaps sewn inside the top near the #3 Bow. Use four (4) #8 x 1/2" Pan Head Washer Screws to secure the flaps to the #3 Bow.

22

4X

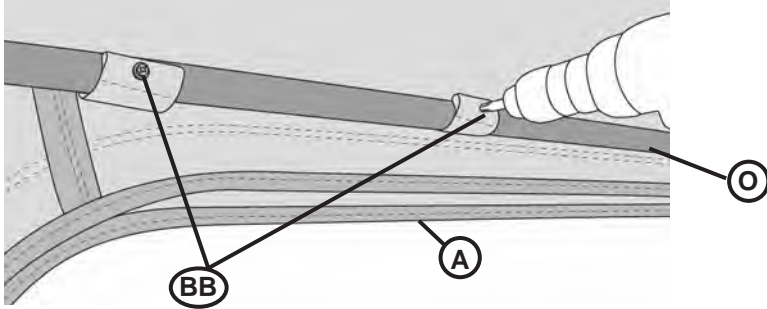

Locate the four (4) flaps sewn inside the top above the rear window opening. Install a #8 x 1/2" Pan Head Washer Screw to secure each flap to the Rear Bow.

23

2X

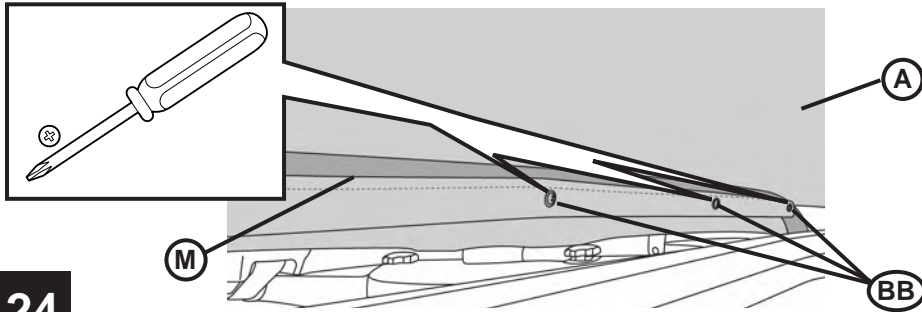

Locate the flaps inside the top in the center. Wrap them around the 2 bow and install five (5) #8 x 1/2" Pan Head Washer Screws.

24

Roll Plastic into Channel

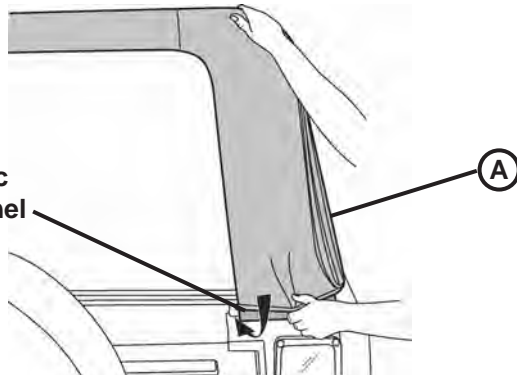

Slip the plastic strip in the rear corners of the Top into the channel on the vehicle.

25

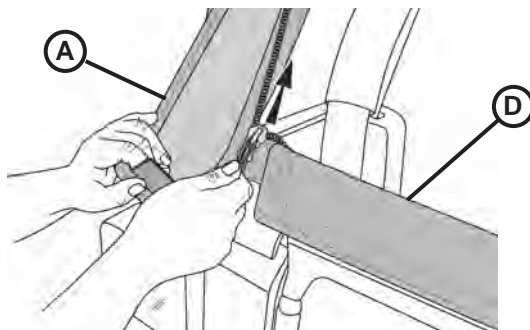

Start the zipper on the Rear Window and close it part of the way around.

26

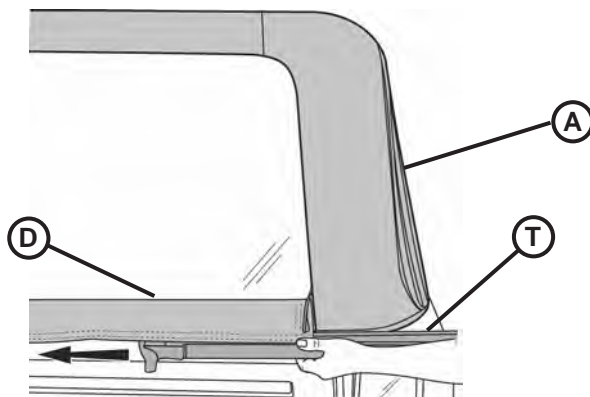

Slide the channel in the Tailgate Bar onto the tubing along the bottom of the Rear Window on the inside.

27

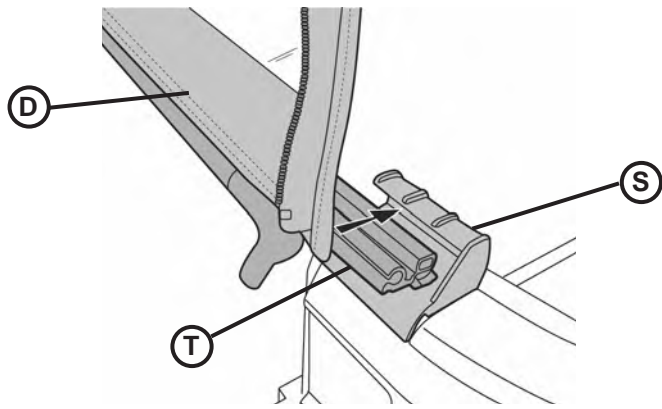

Slide the Tailgate Bar into the Tailgate Mounts on each side of the tailgate opening.

28

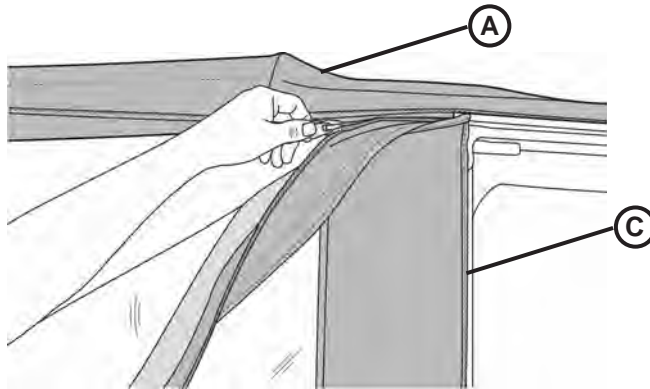

2X

Start the zipper on the Side Window and close it 1-2 inches.

29



2X

Roll the plastic strip along the front of the Side Window into the channel in the Door Surround.

30

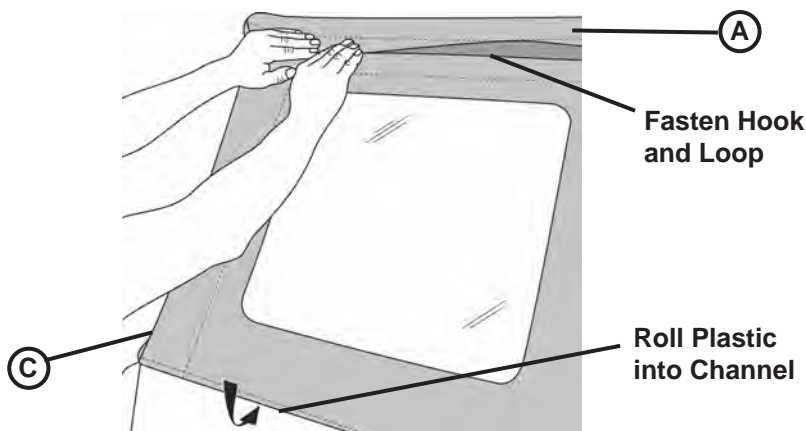

2X

Close the zipper and slip the plastic along the bottom of the Side Window into the channel on the vehicle. Fasten the hook and loop strip above the window to the top.

31



JEEP WRANGLER

Kit de toit amovible pour modèle 4 portes

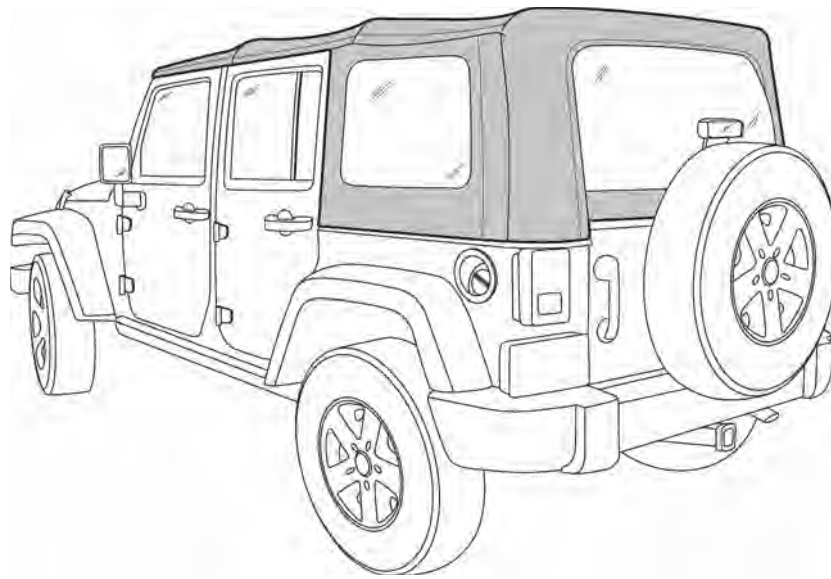

82212264
82212265

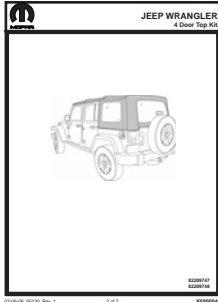

A 1X

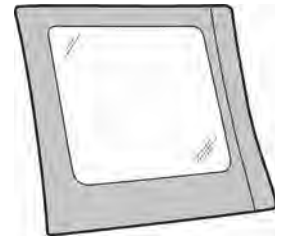

B 1X

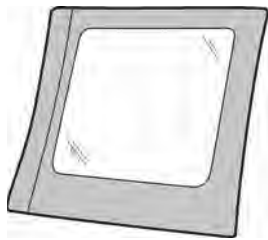

C 1X

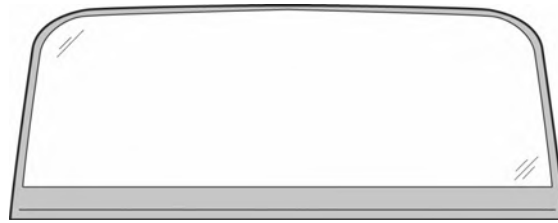

D 1X



E 1X

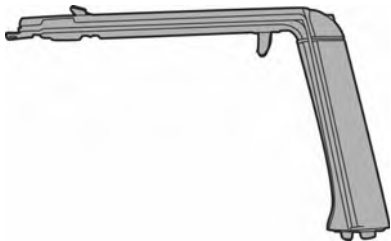

F 1X



G 1X

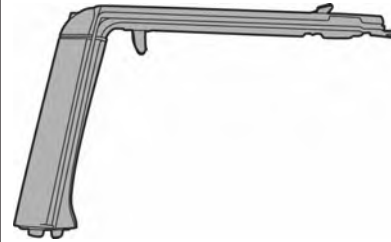

H 1X



I 1X

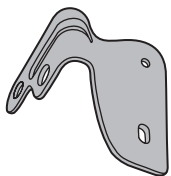

J 1X

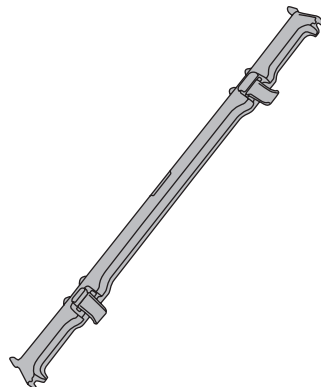



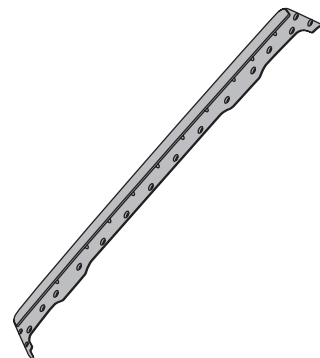



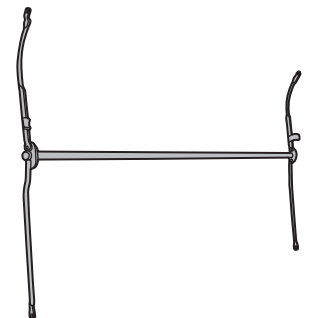

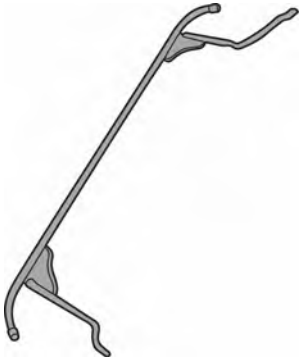
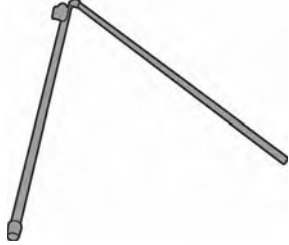
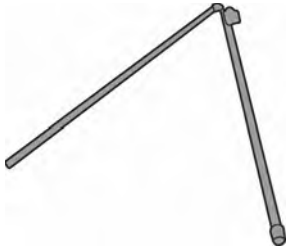

K 1X

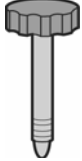

L 1X

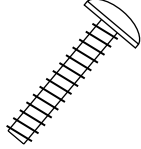
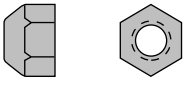
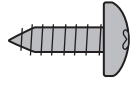
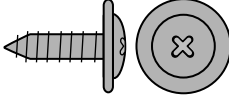
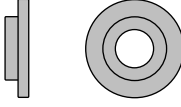
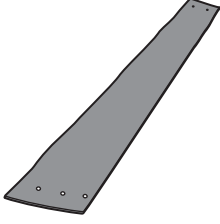
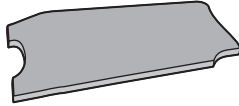
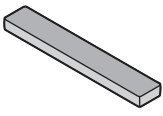

M 1X

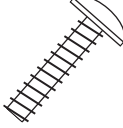
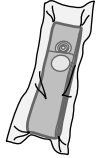
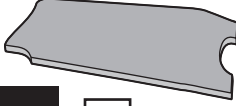
| | | | | |
|---|---|--|---|---|
|  |  |  |  | |
| N 1X | O 1X | P 1X | Q 1X | |
|  |  |  |  | |
| R 1X | S 1X | T 1X | U 4X | |
|  |  |  |  | |
| V 2X | W 4X | X 6X | Y 2X M5 x 30 mm | |
|  |  |  |  |  |
| Z 4X | AA 27X | BB 27X | CC 8X | DD 2X |
|  |  |  |  |  |
| EE 1X | GG 2X | HH 4X | JJ 2X M5 x 16 mm | KK Sangles d'enroulement - 2 élastiques / 2 filets |
|  | | | | |
| FF 1X | | | | |

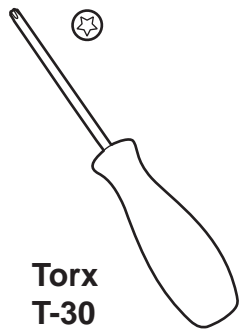

**Torx
T-30**



**Perceuse
Foret cruciforme
n° 2**

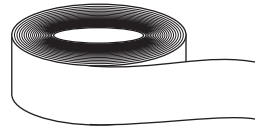

Ruban adhésif

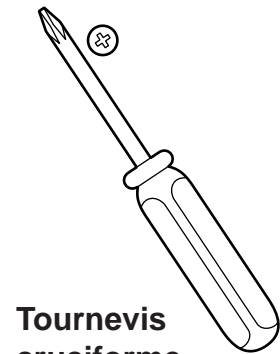
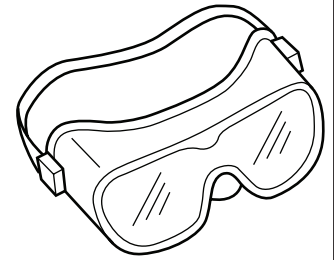

**Tournevis
cruciforme
n° 2**

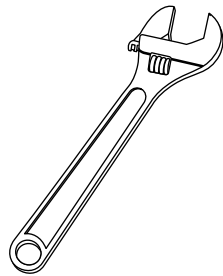

**Clé à
molette**



Pinces

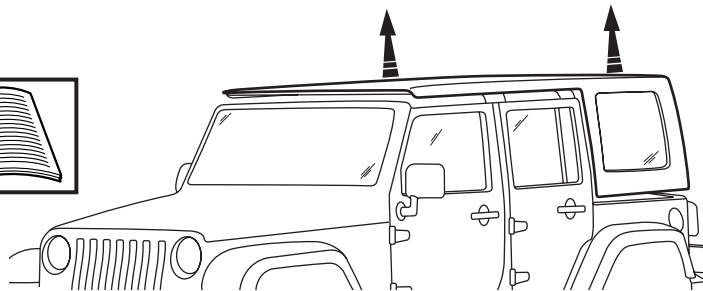

**Retirez le toit amovible.
Reportez-vous au guide
d'utilisation pour les
instructions.**

1

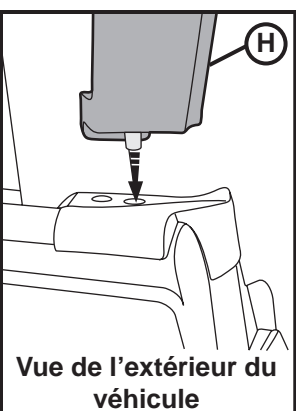

**Vue de l'extérieur du
véhicule**

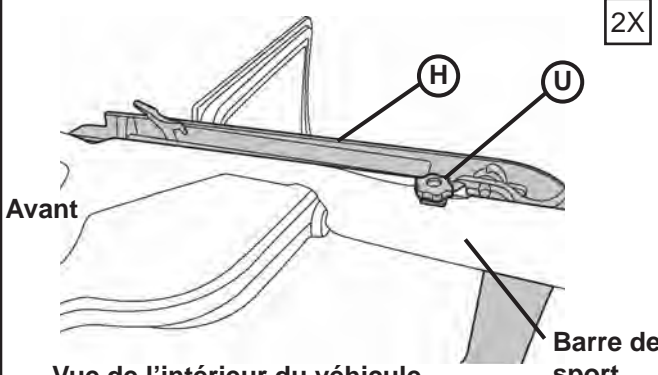

**Vue de l'intérieur du véhicule
Vue côté passager**

**Localisez les
encadrements de porte
arrière gauche et droite.
Insérez la tige du bas
de l'encadrement de
porte dans le trou du rail
d'arrimage derrière la
porte.
Insérez un bouton long
dans la languette de
l'encadrement de porte
et serrez**

2

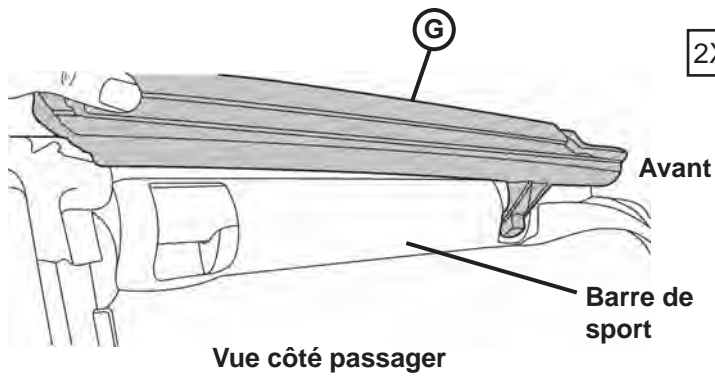

2X

Placez le rail de la porte avant au-dessus de l'ouverture de la porte.

3

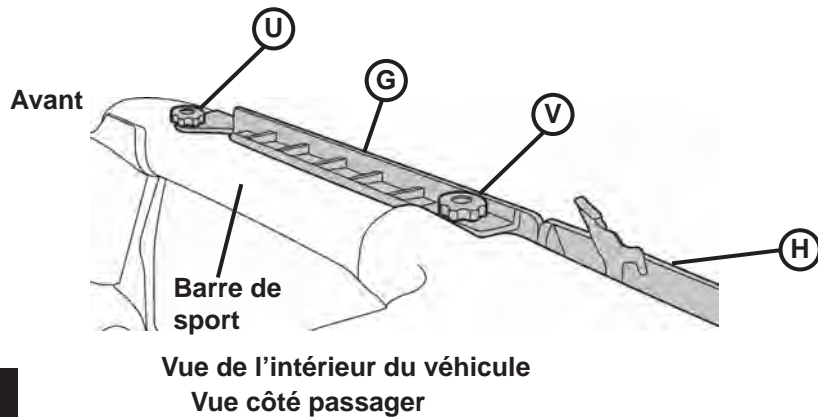

2X

Installez le bouton long à l'avant du rail et un bouton court au centre.

4

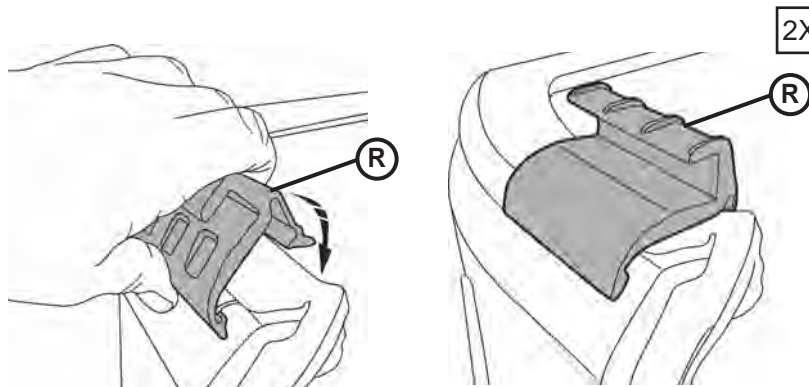

2X

Localisez les montures pour hayon gauche et droite. Orientez-les sur le véhicule. Accrochez le bas de l'une des montures sous le rail d'arrimage et tournez-la vers l'intérieur du véhicule jusqu'à ce qu'elle s'enclenche en place.

Répétez cette étape avec l'autre monture pour hayon.

5

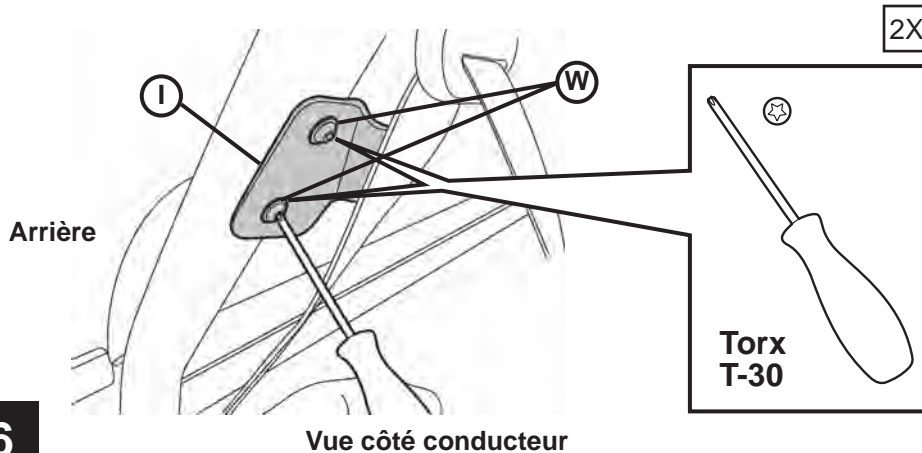

2X

Utilisez les vis de support pour installer les supports de fixation pour arceau sur l'arrière de la barre sport.

6

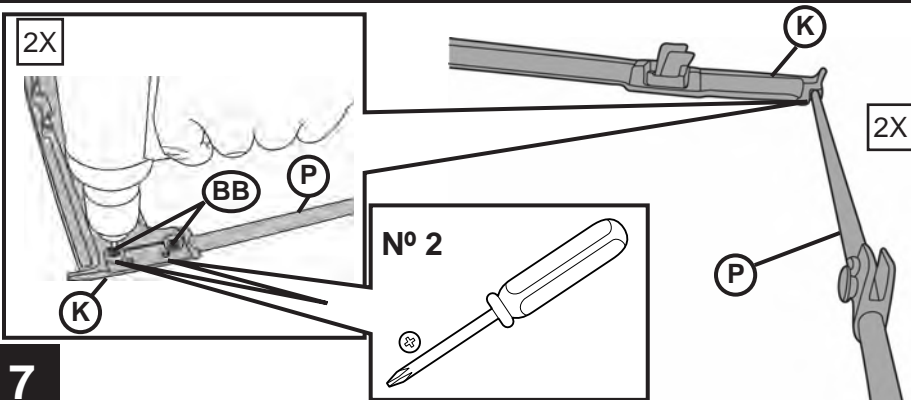

Placez le panneau inférieur sur les arceaux latéraux. Placez les arceaux latéraux de manière à ce que les supports soient orientés vers le haut. Installez deux (2) vis-écrous à tête cylindrique large n° 8 x 1/2 po afin de fixer le panneau inférieur sur chaque arceau latéral.

7

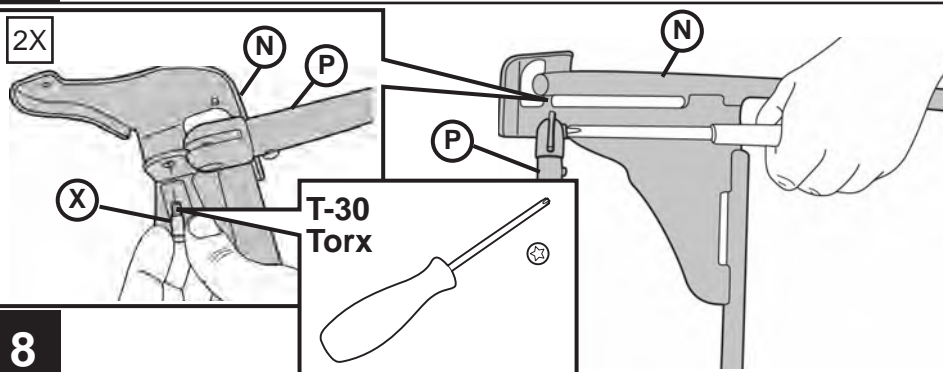

Utilisez un boulon à rotule pivotant pour installer l'arceau n° 3 sur l'ensemble « arceau latéral et panneau ».

8

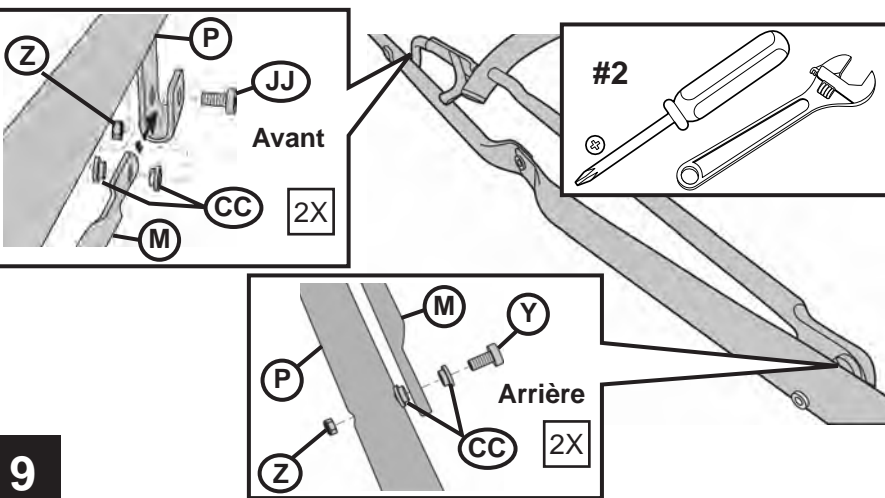

Localisez l'ensemble arceau n° 2. Placez-le sur l'ensemble « arceau latéral et panneau ».

Avant : Installez une vis de mécanique M5 x 16 avec deux (2) douilles et un écrou nyloc M5 sur l'avant de l'arceau latéral.

Arrière : À l'arrière, installez une vis de mécanique M5 x 30 avec deux (2) douilles et un écrou nyloc M5.

Répétez ces étapes sur les deux pattes de l'arceau n° 2.

9

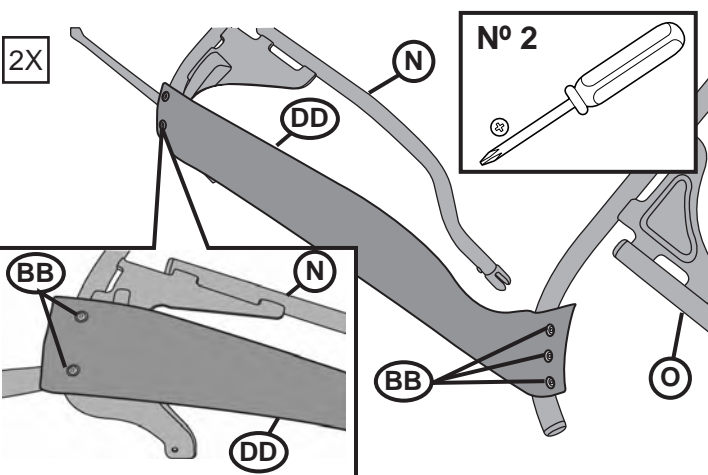

MISE EN GARDE

Assurez-vous que les coussinets d'ancrage de la toile ne sont pas tordus. Orientez le bout carré avec le coussinet d'ancrage (avec 2 trous) vers le rebord extérieur de l'arceau n° 3, la pointe à l'autre bout doit être à l'intérieur et à l'arrière du cadre. Installez deux (2) vis-écrous à tête cylindrique large n° 8 x 1/2 po. Répétez cette étape des deux côtés. Tirez le coussinet d'ancrage de la toile depuis l'arceau n° 3 jusqu'à l'arceau n° 4. Assurez-vous qu'elle n'est pas tordue. Installez trois (3) vis-écrous à tête cylindrique large n° 8 x 1/2 po. Répétez cette étape des deux côtés.

10

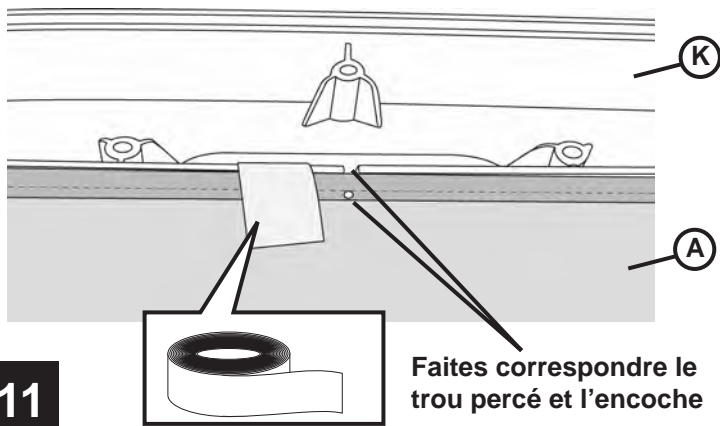

11



MISE EN GARDE

Le trou percé dans la toile et l'encoche dans le panneau inférieur doivent correspondre.

Placez le rebord avant de la toile du toit sur le panneau inférieur de manière à ce que le côté avec revêtement soit vers le haut. Assurez-vous que le trou percé au centre de la toile correspond avec l'encoche du panneau inférieur. Appliquez du ruban adhésif pour maintenir la toile en place.

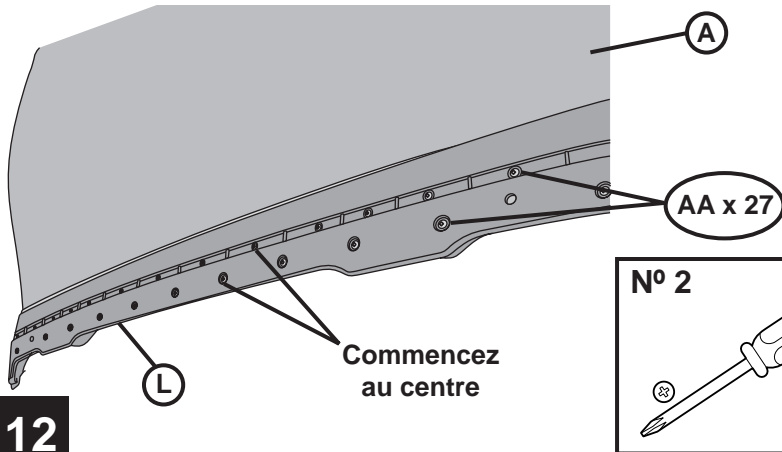

12

Déposez le panneau supérieur sur le toit de manière à ce que la toile soit en sandwich entre le panneau supérieur et le panneau inférieur.

Commencez par le trou du centre et installez vingt-sept (27) vis à tête bombée large cruciformes n° 8 x 1/2 po.

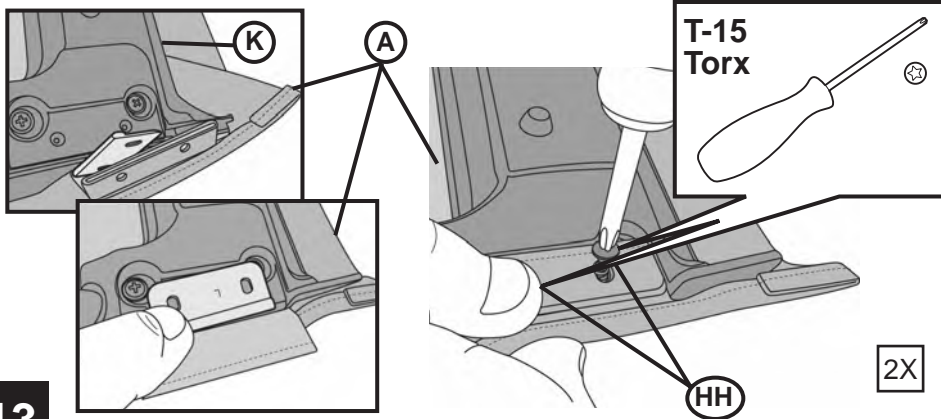

13

Enroulez la toile autour du rebord du panneau. Faites glisser la poche de toile cousue dans le toit entre les panneaux et positionnez le pied d'ancrage.

Installez deux (2) vis à filetage haut et bas à travers la toile et la pièce métallique jusque dans le panneau inférieur de chaque côté.

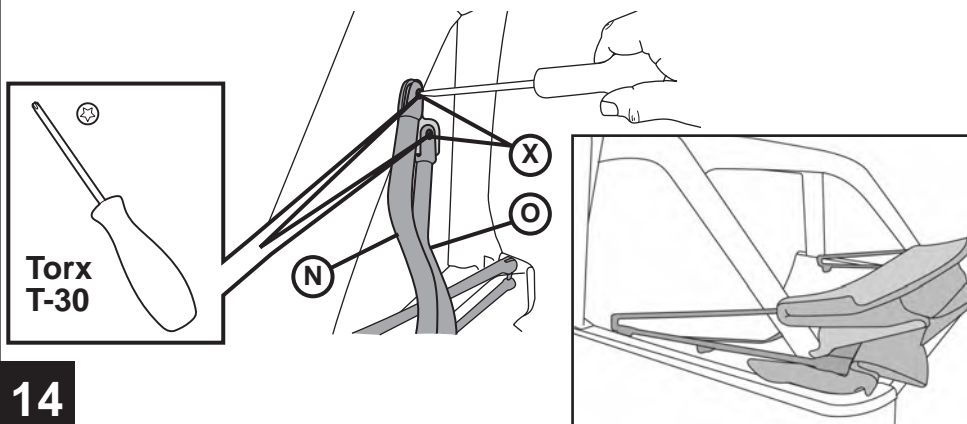

14

Placez le toit sur le véhicule.

Utilisez des boulons à rotule pivotants pour fixer l'arceau arrière de l'ensemble supérieur sur les supports de fixation pour arceau.

2X

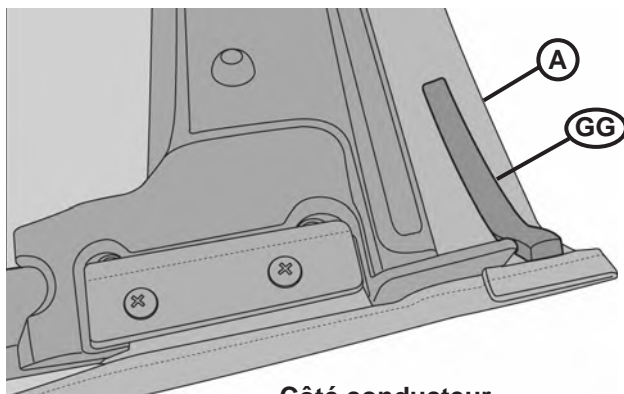

Installez une mousse de
toile sur le panneau.

15

Côté conducteur

EE
(Côté
passager
FF)

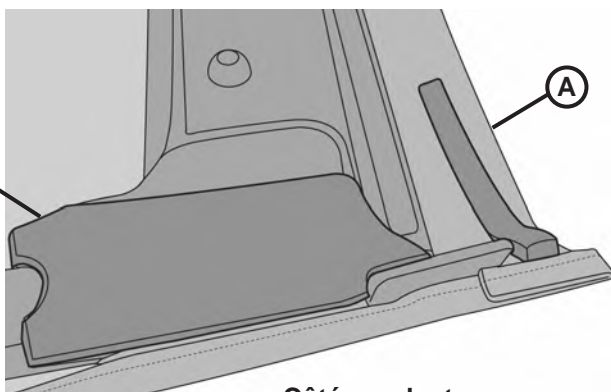

Installez une mousse de
panneau sur le panneau.

16

Côté conducteur



Ouvrez le toit et
recouvrez-en la cabine
du véhicule.

17

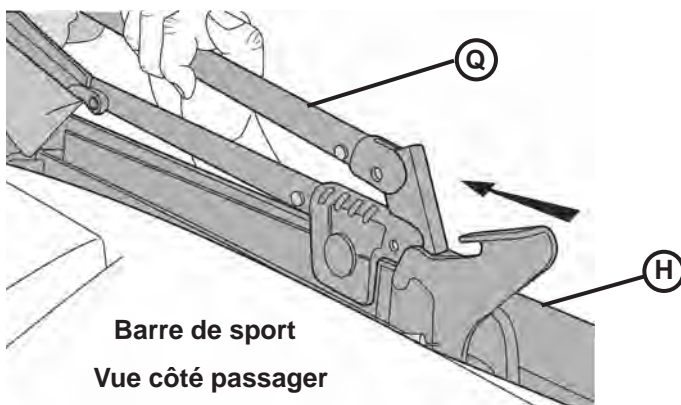

Faites glisser le pivot
du toit le long du
rail au-dessus de la
porte jusqu'à ce qu'il
s'enclenche en place.

18

Barre de sport
Vue côté passager



Tirez la toile de manière à recouvrir les arceaux.

19

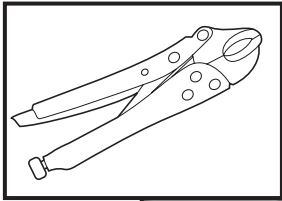

2X

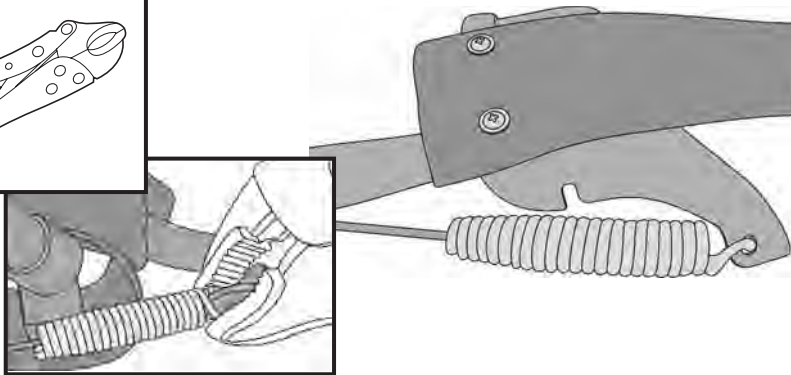

Fixez le ressort-câble au support sur l'arceau et sertissez le ressort.

20

Accrochez le loquet sur le pare-brise

Vue de l'intérieur du véhicule

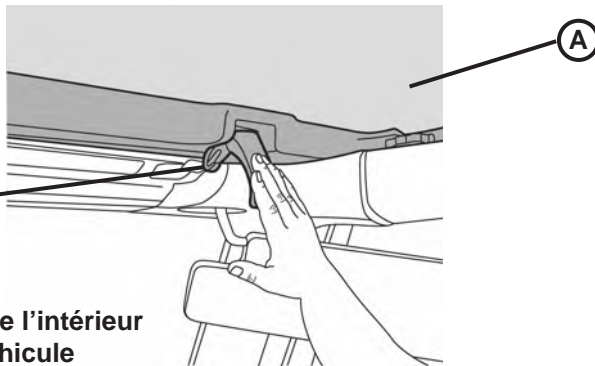

Fermez l'avant du toit et fixez les loquets du toit sur le pare-brise.

21

Une fois le toit en place, localisez les rabats cousus à l'intérieur du toit près de l'arceau n° 3. Utilisez quatre (4) vis-écrous à tête cylindrique large n° 8 x 1/2 po afin de fixer les rabats sur l'arceau n° 3.

22

BB

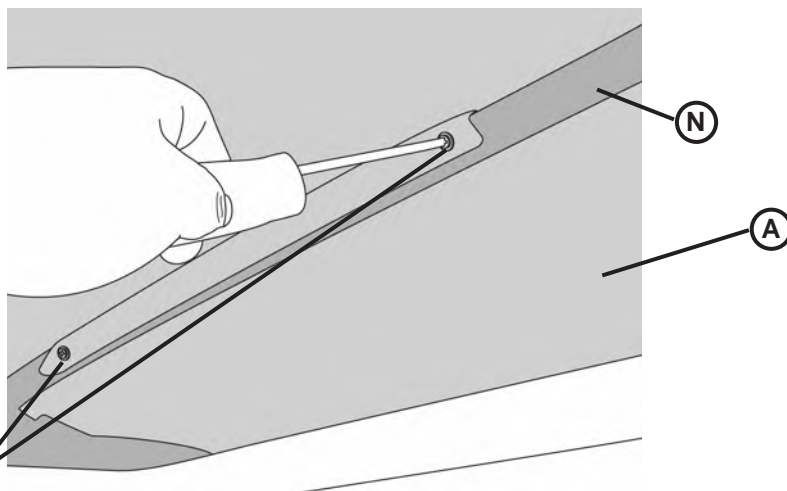

23

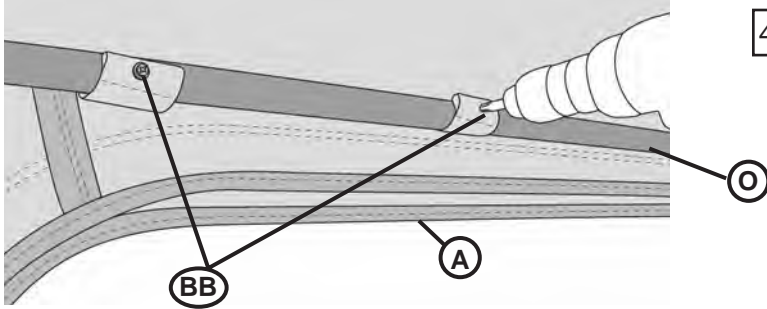

Localisez les quatre (4) rabats cousus à l'intérieur du toit au-dessus de l'ouverture de la fenêtre arrière. Installez une (1) vis-écrou à tête cylindrique large n° 8 x 1/2 po afin de fixer chaque rabat sur l'arceau arrière.

24

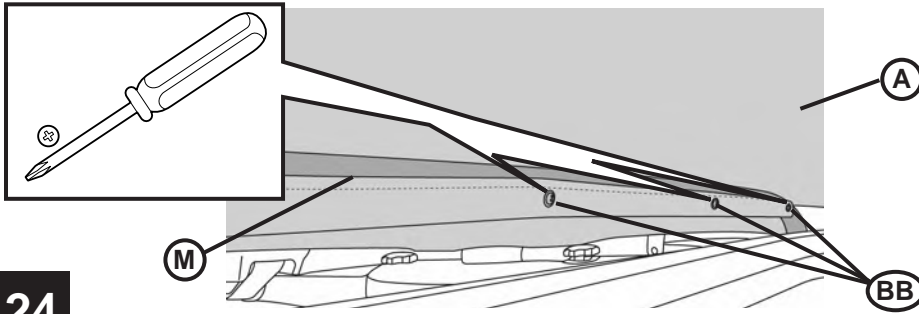

Localisez les rabats à l'intérieur du toit dans le centre. Enroulez-les autour de l'arceau n° 2 et installez cinq (5) vis-écrous à tête cylindrique large n° 8 x 1/2 po.

25

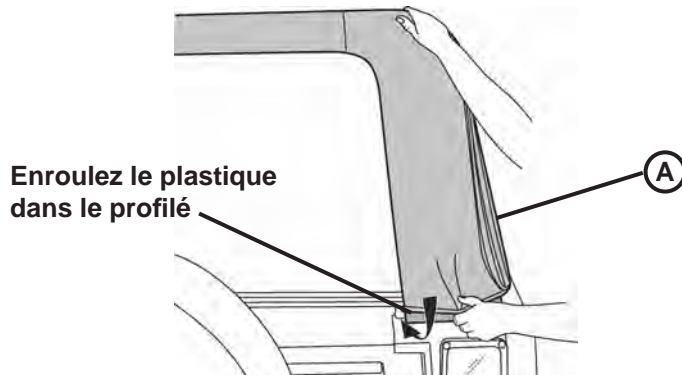

2X

Insérez la languette de plastique dans les coins arrière du toit dans le profilé du véhicule.

26

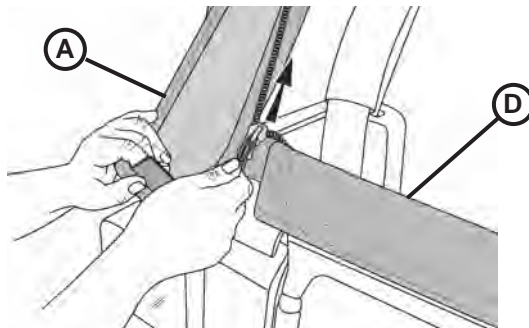

Tirez sur la fermeture à glissière de la fenêtre arrière et fermez-la partiellement sur le pourtour.

27

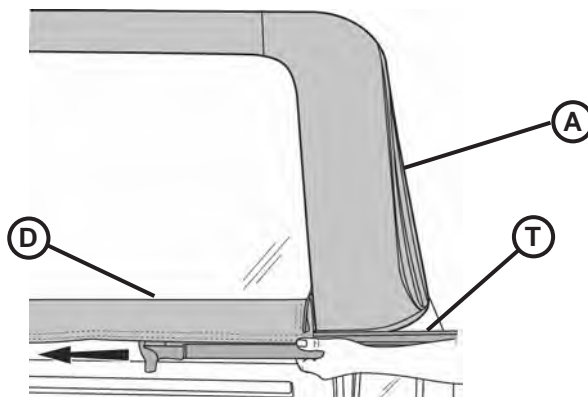

Faites glisser le profilé de la barre de hayon sur la tubulure autour du bas de la fenêtre arrière à l'intérieur.

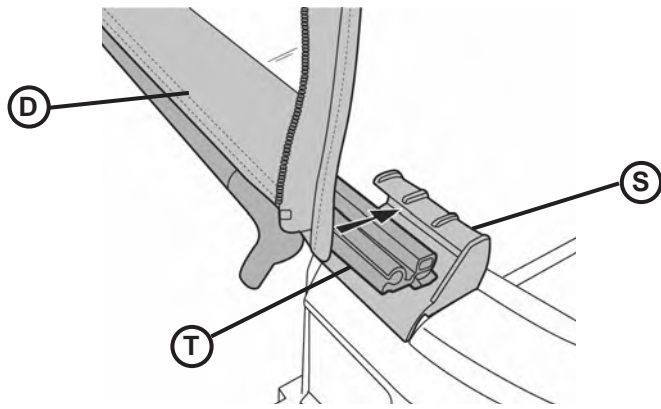

Faites glisser la barre de hayon dans les montures pour hayon de chaque côté de l'ouverture du hayon.

28

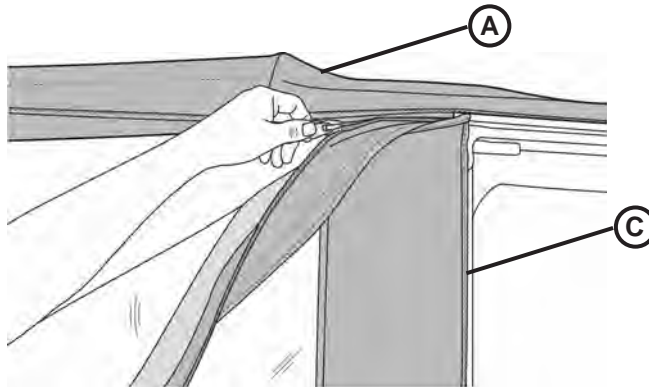

2X

Tirez sur la fermeture à glissière de la fenêtre latérale et fermez-la sur 2,5 à 5 cm (1 à 2 pouces).

29

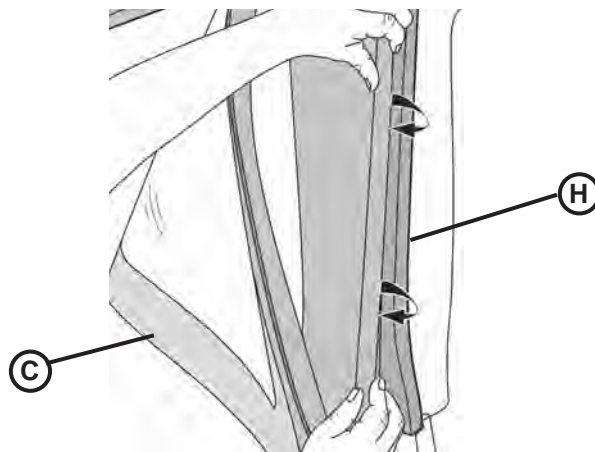

2X

Enroulez la languette de plastique le long de l'avant de la fenêtre latérale dans le profilé de l'encadrement de porte.

30

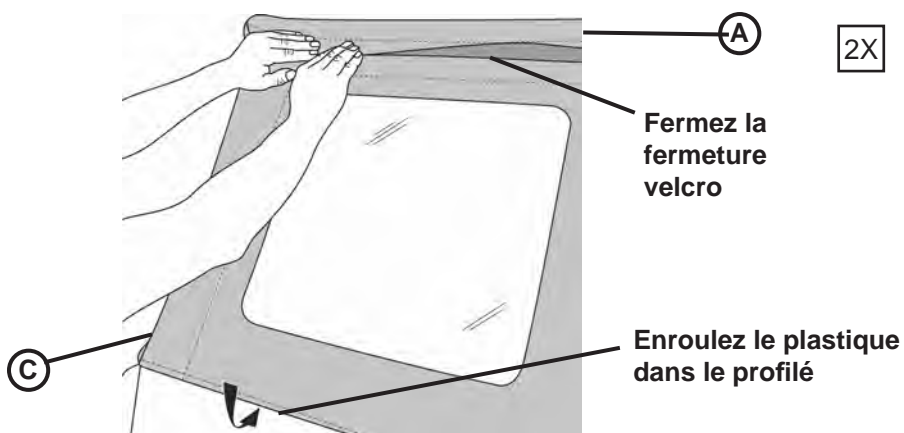

2X

Fermez la fermeture à glissière et faites glisser le plastique le long du bas de la fenêtre latérale dans le profilé du véhicule.

Fixez la fermeture velcro au-dessus de la fenêtre sur le toit.

31



MOPAR®

JEEP WRANGLER

Juego para Tope de Techo para Vehículo de Cuatro Puertas

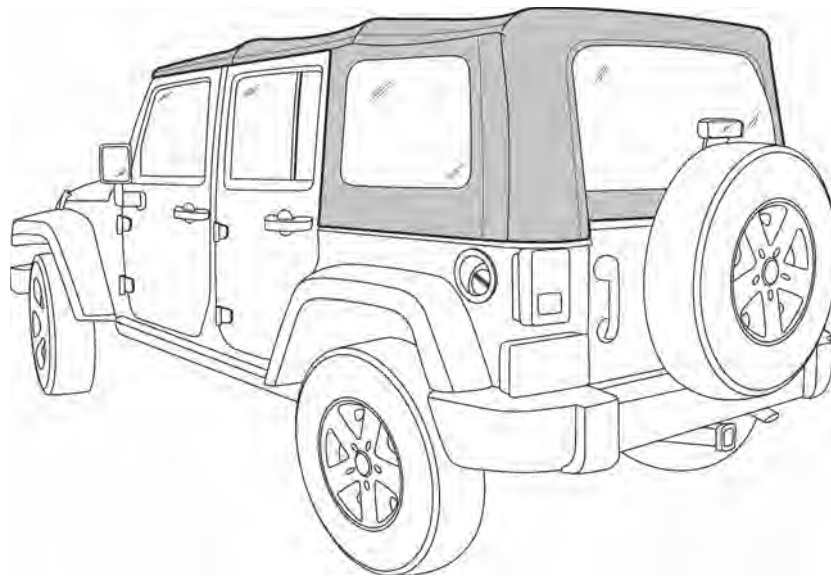

82212264
82212265



A 1X

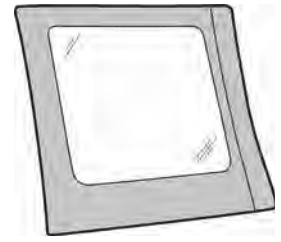

B 1X

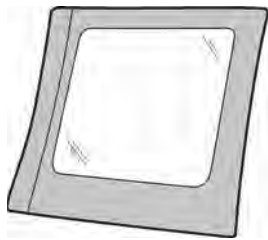

C 1X

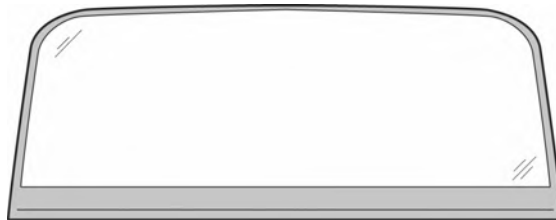

D 1X



E 1X

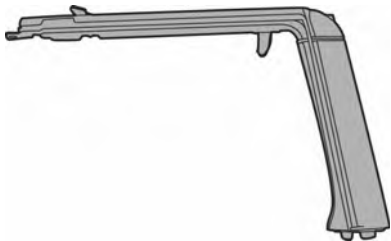

F 1X



G 1X

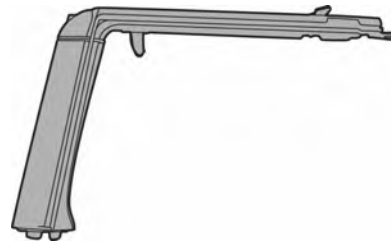

H 1X



I 1X

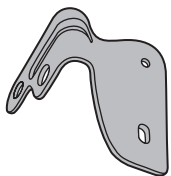

J 1X

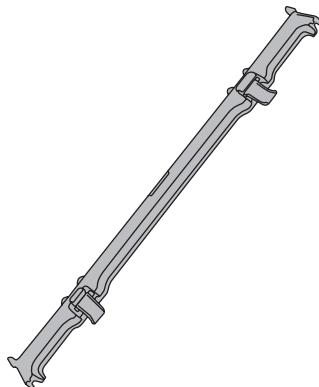



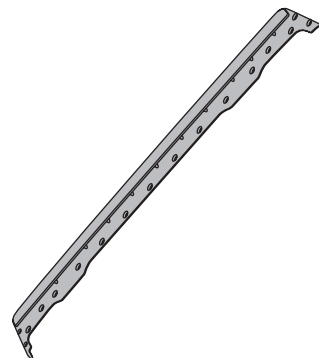



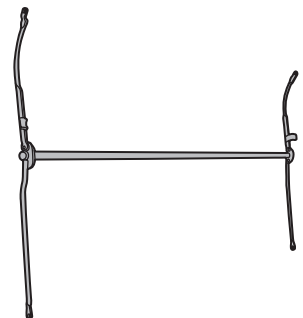



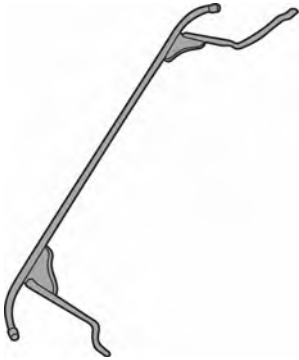
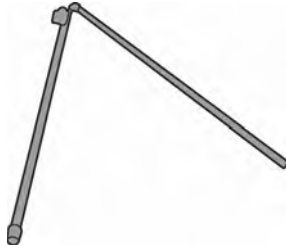

K 1X

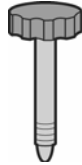

L 1X

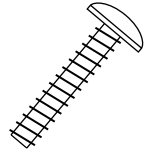

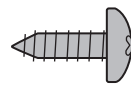
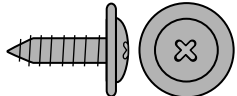
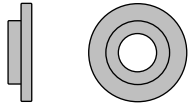
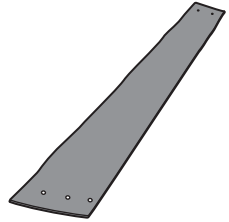
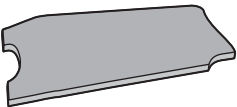
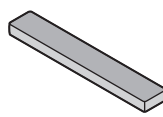
M 1X

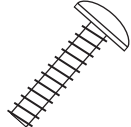
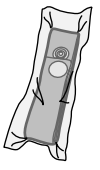
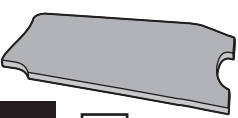
| | | | | |
|---|---|--|---|---|
|  |  |  |  | |
| N 1X | O 1X | P 1X | Q 1X | |
|  |  |  |  | |
| R 1X | S 1X | T 1X | U 4X | |
|  |  |  |  | |
| V 2X | W 4X | X 6X | Y 2X M5 x 30 mm | |
|  |  |  |  |  |
| Z 4X | AA 27X | BB 27X | CC 8X | DD 2X |
|  |  |  |  |  |
| EE 1X | GG 2X | HH 4X | JJ 2X M5 x 16 mm | KK Correas para enrollar – 2 elásticas / 2 de red |
|  | | | | |
| FF 1X | | | | |

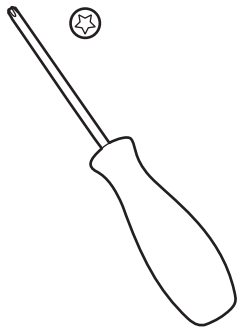

**Destornillador
T-30 Torx**

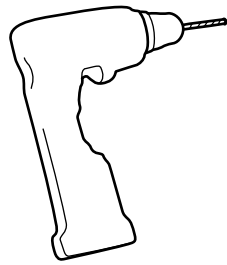

**Taladro con punta
Phillips # 2**

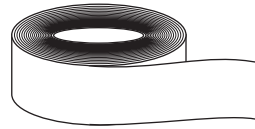

Cinta adhesiva

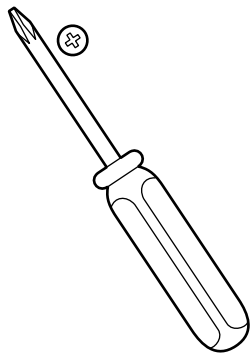
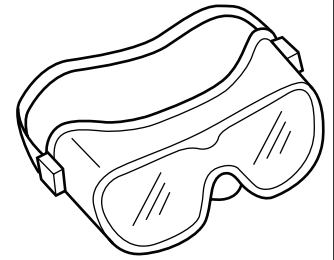

**Destornillador
Phillips # 2**

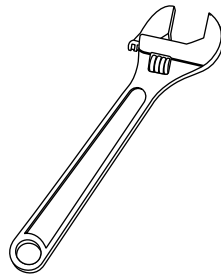

**Llave
ajustable**



Alicate

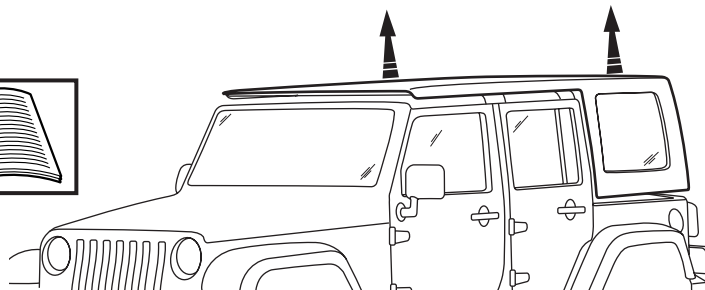

**Retire el techo duro.
Remítase al manual del
propietario para las in-
strucciones.**

1

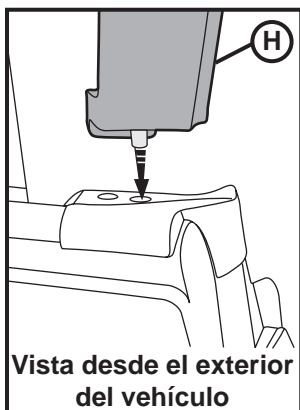

**Vista desde el exterior
del vehículo**

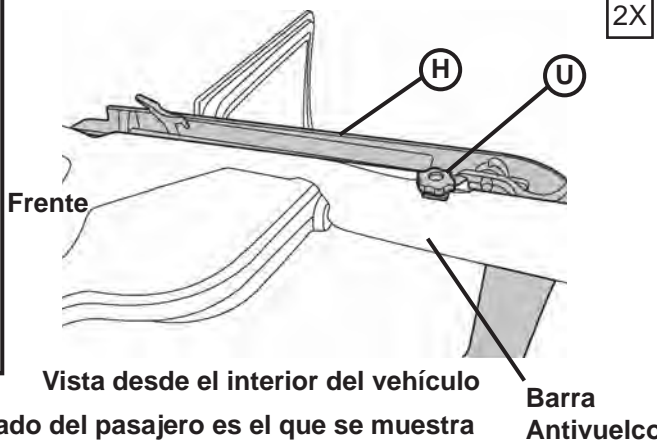

Vista desde el interior del vehículo

**Barra
Antivuelco**

El lado del pasajero es el que se muestra

**Ubique los Marcos de
las Partes Superiores
de las Puertas izquierda
y derecha. Inserte el
pasador en el fondo
del Marco de la Parte
Superior de la Puerta
en el hueco del riel de
la correa detrás de la
puerta.**

**Coloque una Perilla
Grande a través de la
tapa de la Parte Superior
de la Puerta y apriete.**

2

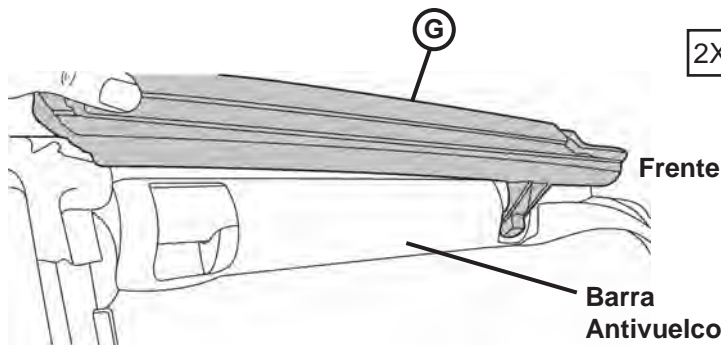

2X

Coloque el Riel de la Puerta de Adelante sobre la parte descubierta de la puerta.

El lado del pasajero es el que se muestra

3

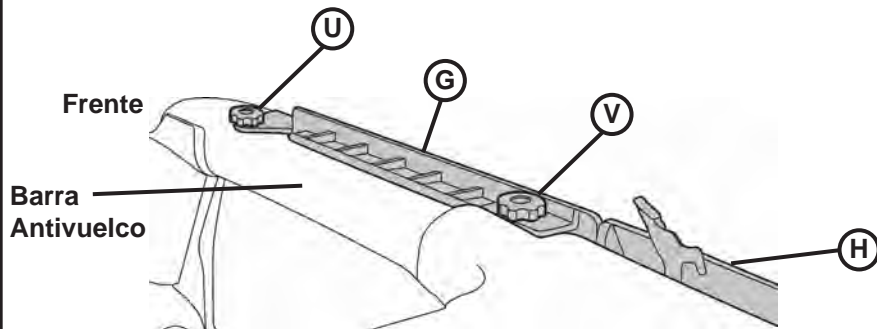

2X

Coloque una Perilla Grande en la parte de enfrente del riel y una Perilla Pequeña en el centro.

Vista desde el interior del vehículo
El lado del pasajero es el que se muestra

4

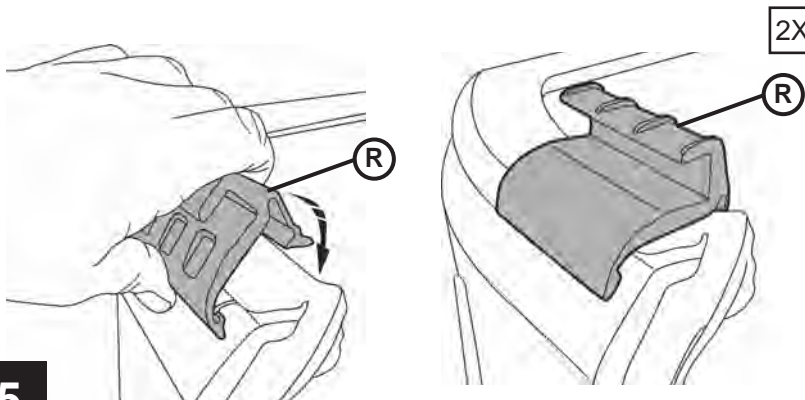

2X

Ubique el bastidor izquierdo y derecho de la Compuerta Trasera. Posiciónelos hacia el vehículo. Enganche la parte de debajo de uno de los bastidores debajo del riel de la correa y enróllelo hacia adentro del vehículo hasta que el gancho lo agarre. Hágalo nuevamente para enganchar el otro Bastidor de la Compuerta Trasera.

5

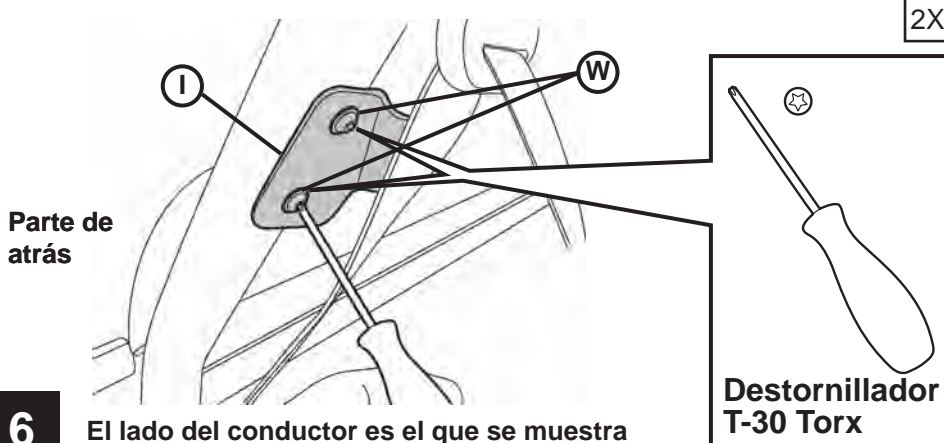

2X

Use los Tornillos para Bisagras para instalar las Bisagras del Bastidor del Armazón sobre la parte trasera de la barra antivuelco.

El lado del conductor es el que se muestra

6

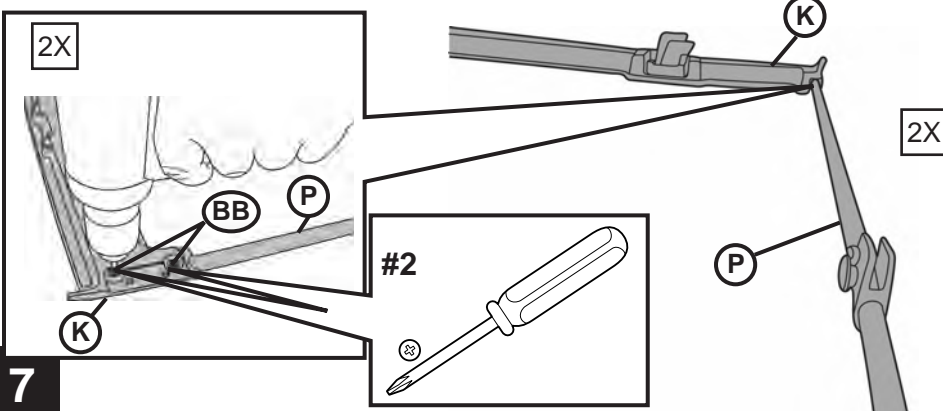

Coloque la Cabecera Inferior sobre los Armazones Laterales. Posicione los Armazones Laterales con las Bisagras hacia arriba. Instale dos (2) Tornillos con Arandela de Cabezal Cilíndrico # 8 x 1/2" para fijar la Cabecera Inferior a cada Armazón Lateral.

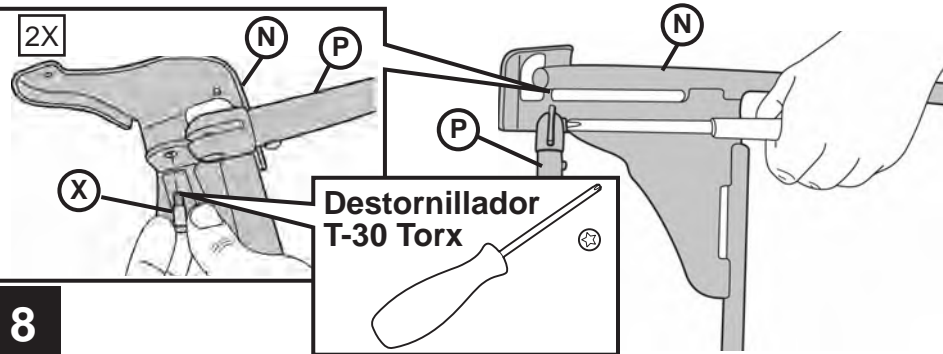

Utilice un Perno de fijación de Bisagras para fijar el Armazón #3 al Conjunto Armazón Lateral/Cabecera.

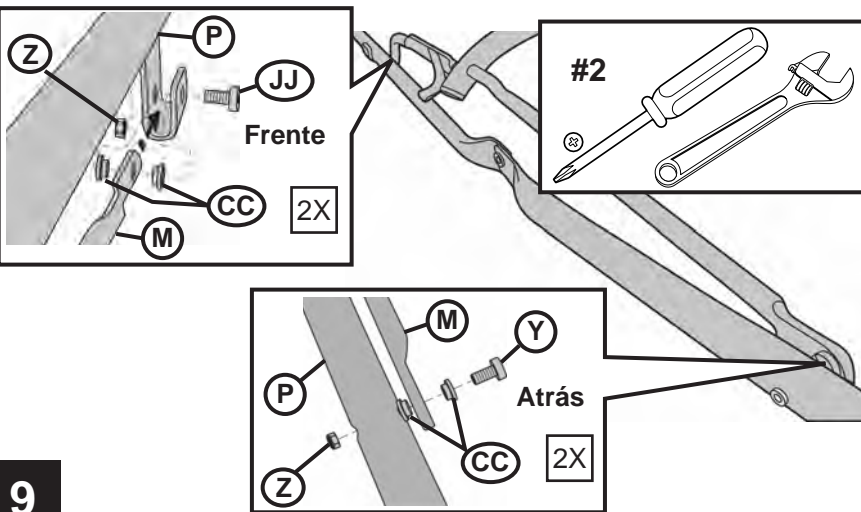

Ubique la Estructura del Armazón #2. Colóquela en el Conjunto Armazón Lateral/Cabecera. Al frente: Coloque un Tornillo Roscado M5 X 16 con (2) Bujes y una Tuerca M5 Nylock de seguridad al frente del armazón lateral. Atrás: En la parte trasera, coloque un Tornillo Roscado M5 x 30 con dos (2) Bujes y una Tuerca M5 Nylock. Repita estos pasos en ambas patas del Armazón #2.

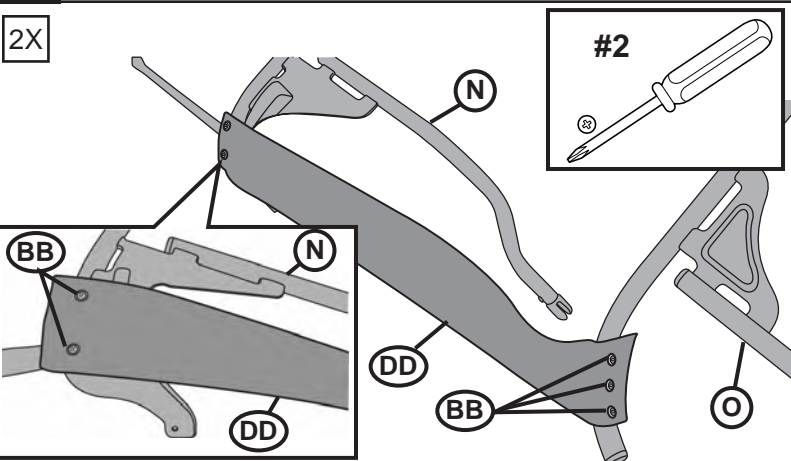

! CUIDADO
No permita que se doble la tela acolchada de fijación. Posicione la esquinera de la tela acolchada (con 2 huecos) en el borde exterior del Armazón #3, el punto al otro lado debería de quedar por dentro y en la parte de atrás del marco Jale la tela acolchada de fijación del Armazón #3 hacia el Armazón #4. Asegúrese de que no se doble. Coloque tres (3) Tornillos con Arandela de Cabezal Redondo # 8 x 1/2". Hágalo en ambos lados.

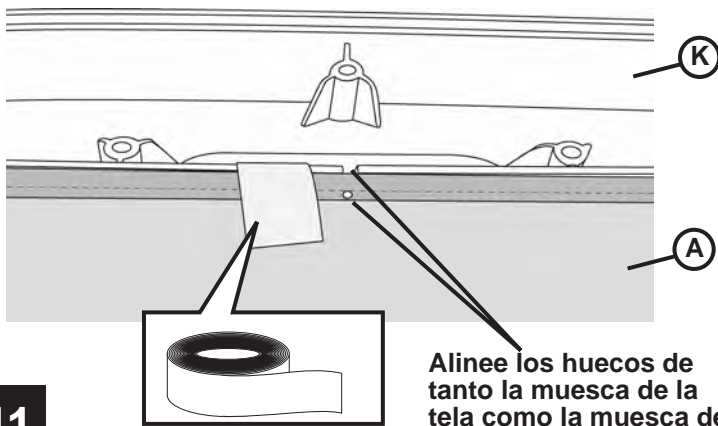

11

Alinee los huecos de tanto la muesca de la tela como la muesca de la Cabecera Inferior

! CUIDADO

Los huecos de tanto la muesca de la tela como la muesca de la Cabecera Inferior deben estar alineados.

Despliegue el borde frontal del tope de la tela sobre la Cabecera Inferior con la cara que posee el respaldo colocada hacia arriba. Cerciñese de que el hueco en el centro de la tela esté alineado con la muesca de la cabecera inferior. Con una Cinta Adhesiva fije la tela en su sitio.

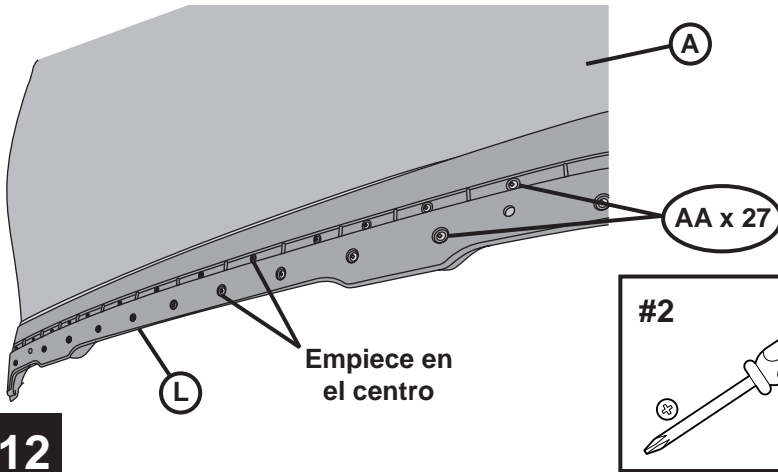

12

Empiece en el centro

#2

Despliegue la Cabecera Superior sobre el tope de manera que la tela esté en el medio de la Cabecera Superior y de la Inferior.

Comience con el orificio en el centro y proceda a colocar veintisiete (27) tornillos de Empuje con Cabezal Phillips # 8 x 1/2".

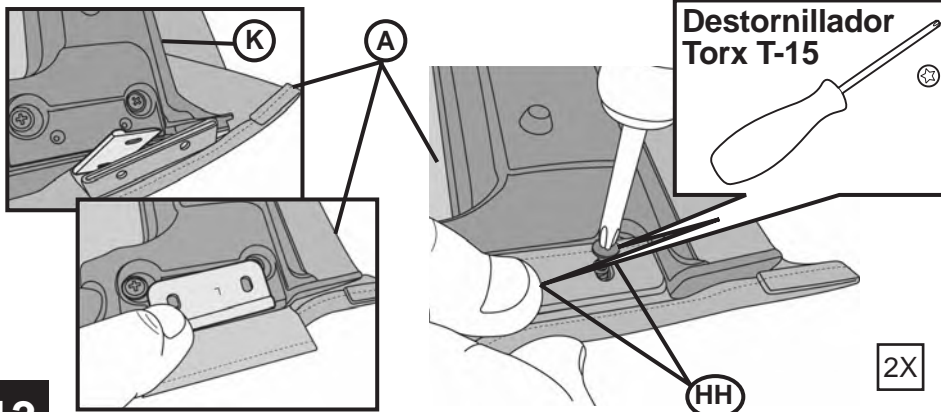

13

Destornillador Torx T-15

Enrolle la tela alrededor del borde de la cabecera. Deslice el bolsillo de tela zurcido adentro del techo y entre las cabeceras y el pie de anclaje.

Instale dos tornillos roscados Hi-Low a través de la tela y la banderilla metálica y en cada lado de la Cabecera Inferior.

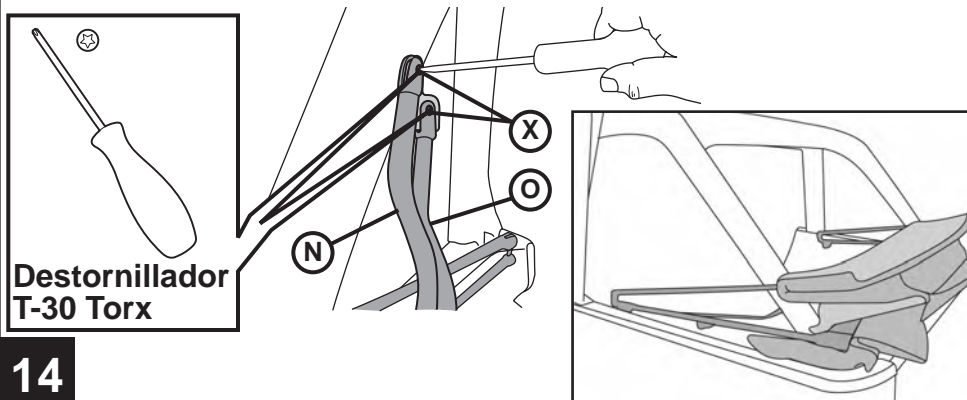

14

Destornillador T-30 Torx

Coloque la Estructura del Techo sobre el vehículo. Utilice los Pernos de Fijación para Bisagras para fijar el Armazón Trasero en la Estructura del Techo a las Bisagras de los Bastidores.

2X

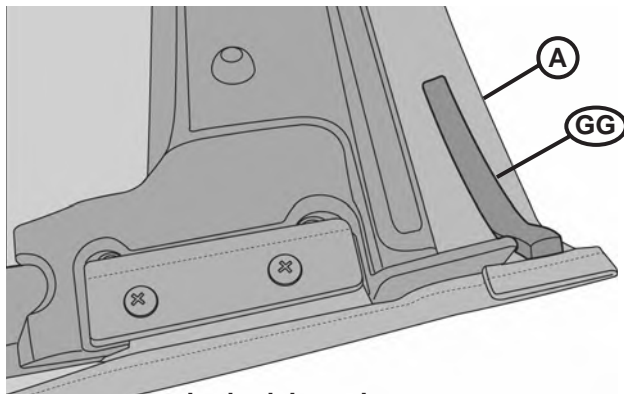

Coloque la tela con goma espuma en la Cabecera.

15

Lado del conductor

EE
(Lado del pasajero
FF)

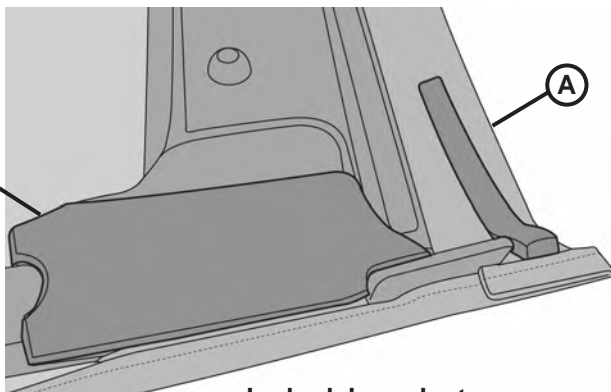

Instale la Cabecera con Goma Espuma en la Cabecera.

16

Lado del conductor



Saque la Estructura del Techo y córrala sobre la cabina del vehículo.

17

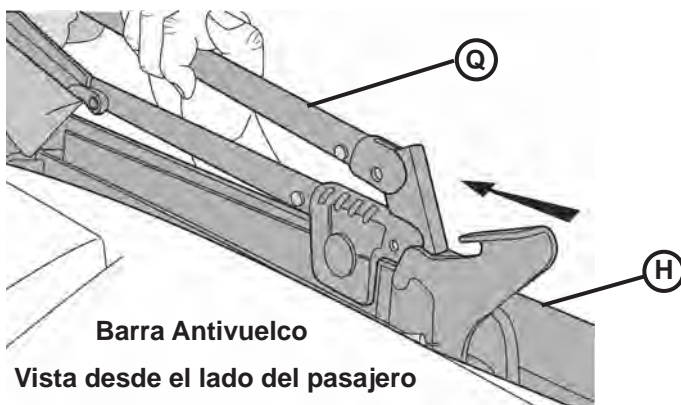

Deslice la Estructura Basculante en el Techo a lo largo de la carrilera sobre la puerta hasta que enganche y caiga en su sitio.

18

Barra Antivuelco
Vista desde el lado del pasajero



Coloque la tela sobre las estructura con las armazones.

19

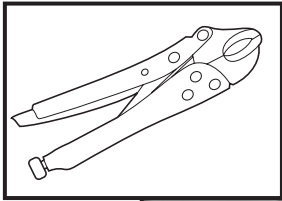

2X

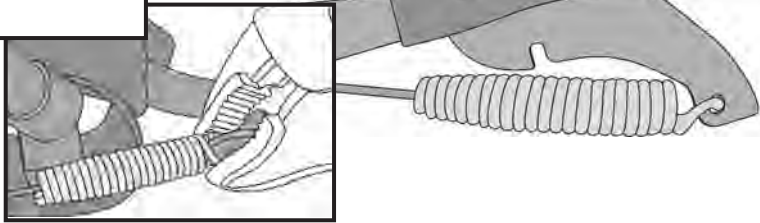

Asegure el Cable del Resorte a la bisagra del armazón y atenace la punta del resorte.

20

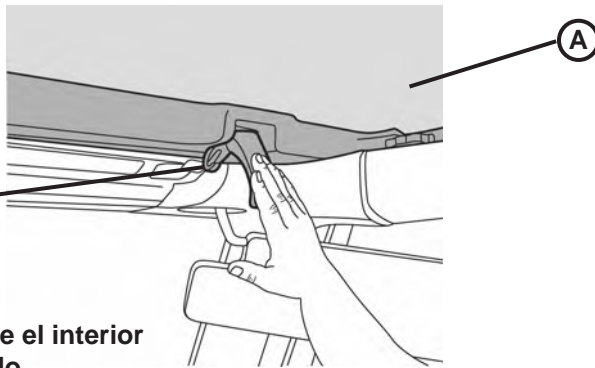

Instale el gancho en el parabrisas

Vista desde el interior del vehículo

Cierre la parte frontal del Techo y asegúrelo al parabrisas con los ganchos en la cabecera.

21

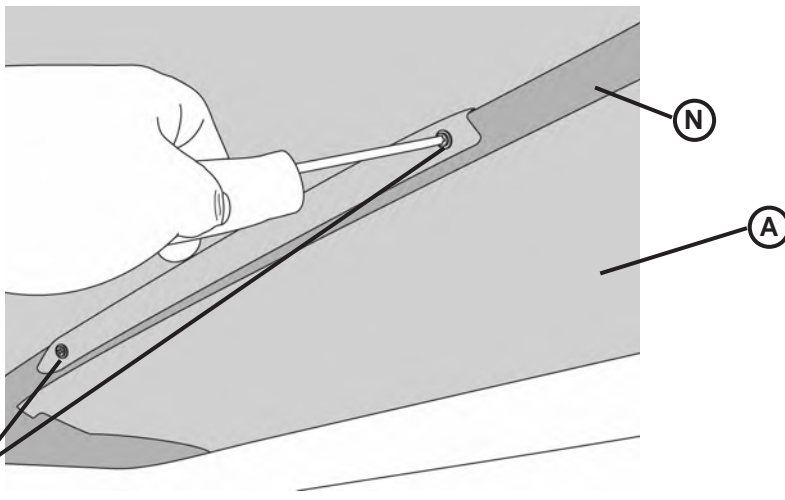

Una vez que se ha colocado el techo en su sitio, coloque los alerones zurcidos dentro del techo, cerca del Armazón # 3. Utilice (4) Tornillos con Arandela de Cabezal Redondo de # 8 x 1/2" para así fijar los alerones a la Armazón # 3.

22

23

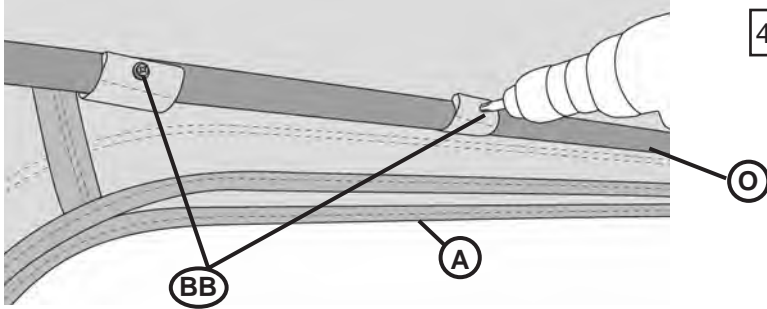

4X

Coloque los cuatro (4) alerones zurcidos dentro del techo, arriba de la abertura de la ventana trasera. Coloque un Tornillo con Arandela de Cabezal Redondo de # 8 x 1/2" para así fijar cada alerón al Armazón Trasero.

24

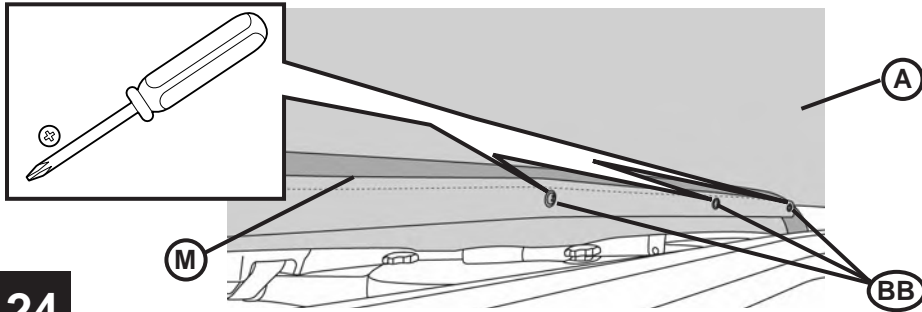

Ubique los alerones dentro del techo en el centro. Enróllelos alrededor del Armazón 2 y coloque (5) Tornillos con Arandela de Cabezal Redondo de # 8 x 1/2".

25

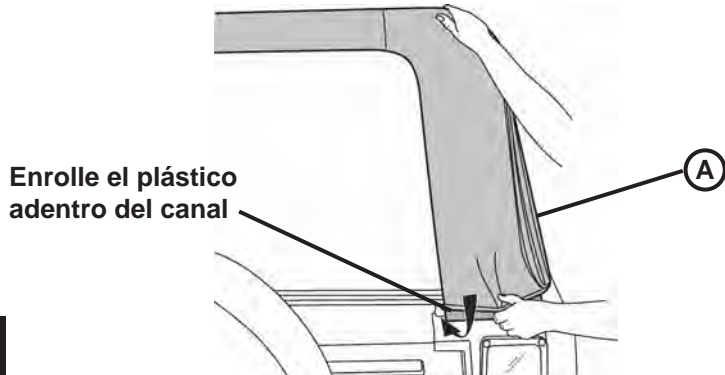

2X

Deslice las tiras plásticas ubicadas en las esquinas traseras del Techo adentro del canal tubular en el vehículo.

26

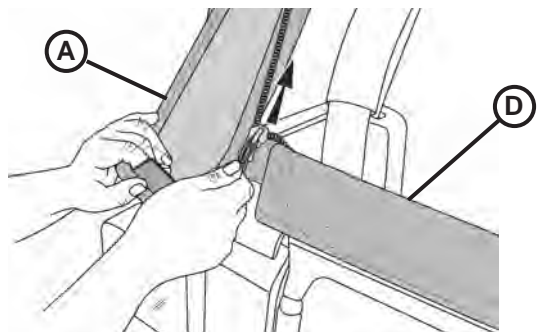

Proceda a cerrar la cremallera en la Ventana Trasera y cierre parte de ese marco.

27

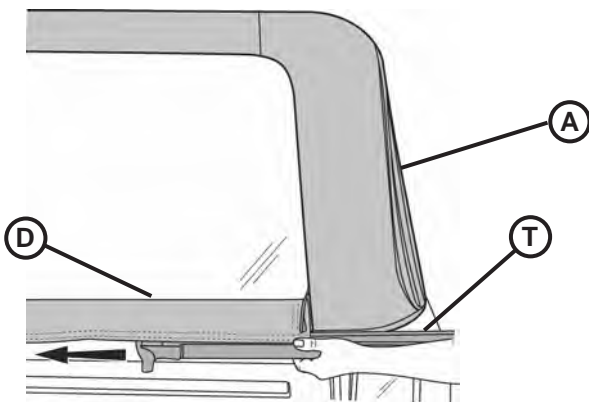

Deslice el canal tubular en la Barra de la Compuerta Trasera sobre el tubular ubicado a lo largo del fondo de la parte de adentro de la Ventana Trasera.

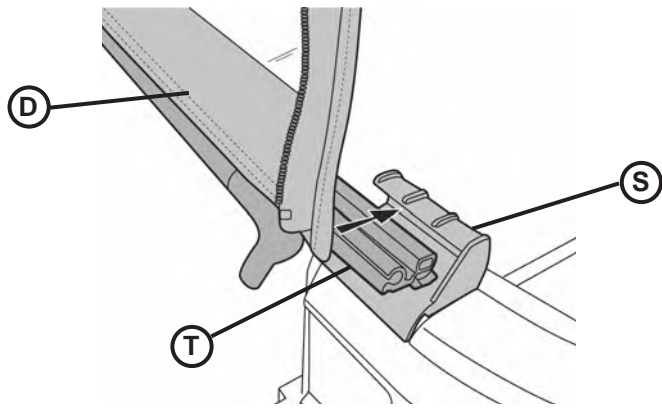

Deslice la Barra de la Compuerta Trasera adentro de los Bastidores de la Compuerta Trasera a cada lado de la abertura de la compuerta trasera.

28

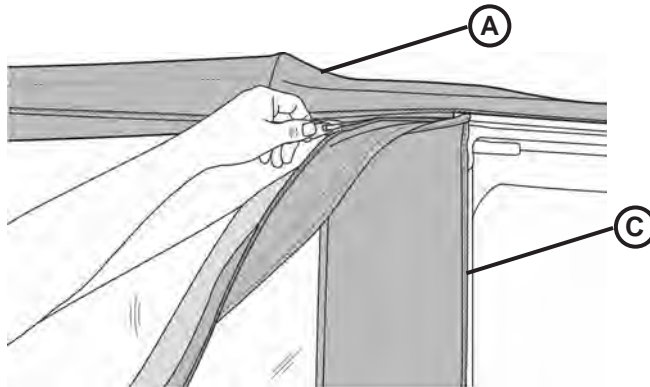

2X

Proceda a cerrar la cremallera ubicada en la Ventana Lateral y ciérrela sólo en 1 ó 2 pulgadas.

29

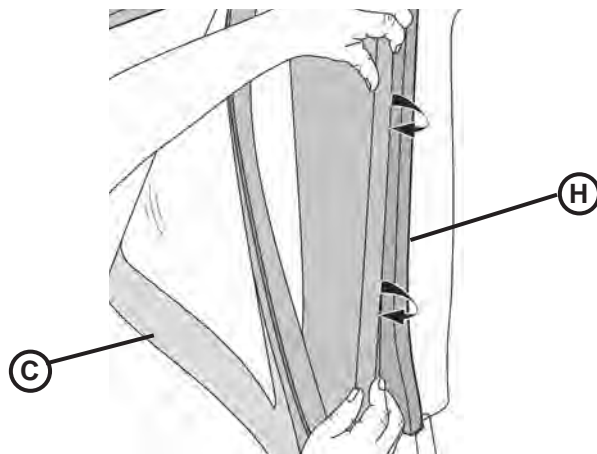

2X

Enrolle la tira plástica ubicada a lo largo de la parte frontal de la Ventana Lateral adentro del canal en el Marco de la Parte Superior de la Puerta.

30

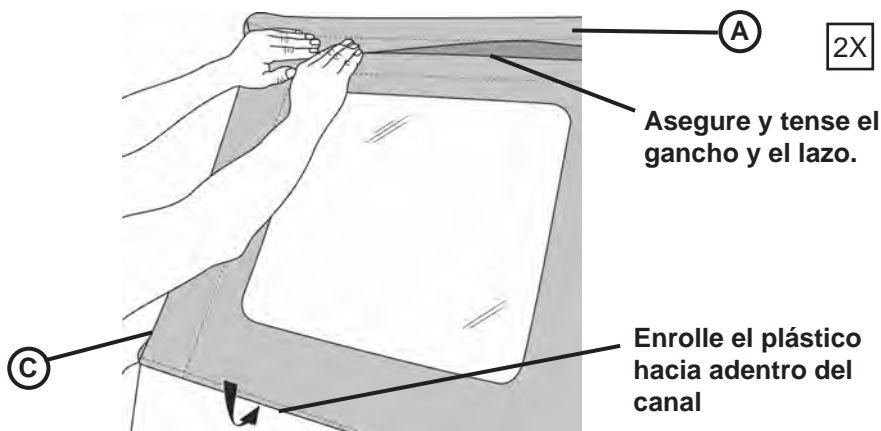

2X

Cierre la cremallera y deslice el plástico a lo largo del fondo de la Ventana Lateral adentro del canal tubular en el vehículo. Asegure y tense el gancho y el lazo que están sobre ventana al techo.

31