

ROUGH COUNTRY

SUSPENSION SYSTEMS®

2023 SUPERDUTY 3" LIFT KIT - SPRING

Thank you for choosing Rough Country for your suspension needs.

Rough Country recommends a certified technician installs this system. In addition to these instructions, professional knowledge of disassemble/reassembly procedures as well as post installation checks must be known. Attempts to install this system without this knowledge and expertise may jeopardize the integrity and/or operating safety of the vehicle.

Please read all the instructions before beginning the installation. Check the kit hardware against the parts list. Be sure you have all the needed parts and understand where they go. Also please review the tools needed list and make sure you have needed tools.

PRODUCT USE INFORMATION

⚠ WARNING As a general rule, the taller a vehicle is the easier it will roll. Seat belts and shoulder harnesses should be worn at all times. Avoid situations where a side rollover may occur.

Braking performance and capabilities are decreased when significantly larger/heavier tires and wheels are used. Take this into consideration while driving. Also, speedometer recalibration is necessary when larger tires are installed.

Do not add, alter, or fabricate any factory or after-market parts which increase vehicle height over the intended height of the Rough Country product purchased. Mixing component brands, lifts, and/or combining body lift with suspension lifts voids all warranties. Rough Country makes no claims regarding lifting devices and excludes any and all implied claims. We will not be responsible for any product that is altered.

This 3" suspension system was developed for **35x12.50x17** tire on an 8" wheel.

This 3" system comes standard with a 4" block and u-bolt set-up for the rear to give the truck a level look. Personal preference, OE options, and aftermarket add-ons may require additional lifting options. **On vehicles with dual rear wheels the use of blocks and longer u-bolts is not recommended and should not be installed.**

⚠ NOTICE NOTICE TO DEALER AND VEHICLE OWNER

Any vehicle equipped with any Rough country product must have the "Warning to Driver" decal installed on the sun visor / dash. The decal is to act as a constant reminder for whoever is operating the vehicle of its unique handling characteristics. **INSTALLING DEALER**—It is your responsibility to install the warning decal and to forward these installation instructions on too the vehicle owner for review and to be kept in the vehicle for its service life.



2023 - 43630 N3 Kit Contents:

Kit Boxes Containing:

43630992:

- 1 - 43430BAG2
- 1 - 81052BAG
- 1 - Pass. Brake Line Bracket
- 1 - Dr. Brake Line Bracket
- 2 - Radius Arm Drop Bracket
- 2 - Headlight Sensor Bracket

1502BOX2:

- 2 - 4" Blocks
- 4 - 5/8" x 3 1/8" x 13 1/2" U-Bolts
- 1 - 5/8BAG

50220BOX1:

- 1 - Track Bar Bracket
- 4 - 5/8" x 3 5/8" x 13 1/2" U-Bolts
- 1 - 5/8BAG
- 1 - 50220BAG

7669 (Overload Models Only)

- 4 - 5/8" x 3 5/8" x 16" U-Bolts

23313

- N3 Front Shock Pair

23190

- N3 Rear Shock Pair

9461

- Front 3" Coil Pair

Tools Needed:

- 10mm Socket
- 18mm Socket
- 18mm Wrench
- 19mm Socket
- 19mm Wrench
- 21mm Socket
- 21mm Wrench
- 23mm Socket
- 24mm Socket
- 30mm Socket
- Jack Stands
- Floor Jack
- Wheel Chocks
- 1 1/8" Socket
- 1 1/16" Wrench
- 1/8" Allen Wrench

Torque Specs:

Size	Grade 5	Grade 8	Size	Class 8.8	Class 10.9
5/16"	15 ft/lbs	20ft/lbs	6MM	5ft/lbs	9ft/lbs
3/8"	30 ft/lbs	35ft/lbs	8MM	18ft/lbs	23ft/lbs
7/16"	45 ft/lbs	60ft/lbs	10MM	32ft/lbs	45ft/lbs
1/2"	65 ft/lbs	90ft/lbs	12MM	55ft/lbs	75ft/lbs
9/16"	95 ft/lbs	130ft/lbs	14MM	85ft/lbs	120ft/lbs
5/8"	135ft/lbs	175ft/lbs	16MM	130ft/lbs	165ft/lbs
3/4"	185ft/lbs	280ft/lbs	18MM	170ft/lbs	240ft/lbs

Kit Bags Containing:

43430BAG2:

- 2 - 18mm Lock Nut
- 4 - 18mm Flat Washer
- 2 - 18mm x 130mm Bolt
- 2 - 7/16" x 1 1/4" Bolt
- 2 - 7/16" Lock Nut
- 4 - 7/16" Flat Washer
- 2 - 3/8" Flanged Lock Nut
- 2 - 3/8" x 1 1/4" Bolt
- 2 - 3/8" Flat Washer
- 2 - Sleeve
- 4 - 5/16" x 1" Bolt
- 4 - 5/16" Flanged Lock Nut
- 4 - 5/16" Flat Washer
- 2 - #10 x 5/8" Button Head Bolt
- 2 - #10 Lock Nut

1502BAG2:

- 2-14mm x 130mm Bolts

50220BAG:

- 2 - 3" Cam Plate

5/8BAG x 2:

- 8 - 5/8" Lock Nut
- 8 - 5/8" Flat Washers

81052BAG

- 2 - 1/2" Flat Washer



2023 - 43640 M1 Kit Contents:

Kit Boxes Containing:

43630992:

- 1 - 43430BAG2
- 1 - 81052BAG
- 1 - Pass. Brake Line Bracket
- 1 - Dr. Brake Line Bracket
- 2 - Radius Arm Drop Bracket
- 2 - Headlight Sensor Bracket

1502BOX2:

- 2 - 4" Blocks
- 4 - 5/8" x 3 1/8" x 13 1/2" U-Bolts
- 1 - 5/8BAG

7669 (Overload Models Only)

- 4 - 5/8" x 3 5/8" x 16" U-Bolts

50220BOX1:

- 1 - Track Bar Bracket
- 4 - 5/8" x 3 5/8" x 13 1/2" U-Bolts
- 1 - 5/8BAG
- 1 - 50220BAG

770839P

- M1 Front Shock Pair

770804P

- M1 Rear Shock Pair

9461

- Front 3" Coil Pair

Kit Bags Containing:

43430BAG2:

- 2 - 18mm Lock Nut
- 4 - 18mm Flat Washer
- 2 - 18mm x 130mm Bolt
- 2 - 7/16" x 1 1/4" Bolt
- 2 - 7/16" Lock Nut
- 4 - 7/16" Flat Washer
- 2 - 3/8" Flanged Lock Nut
- 2 - 3/8" x 1 1/4" Bolt
- 2 - 3/8" Flat Washer
- 2 - Sleeve
- 4 - 5/16" x 1" Bolt
- 4 - 5/16" Flanged Lock Nut
- 4 - 5/16" Flat Washer
- 2 - #10 x 5/8" Button Head Bolt
- 2 - #10 Lock Nut

1502BAG2:

- 2-14mm x 130mm Bolts

50220BAG:

- 2 - 3" Cam Plate

5/8BAG x 2:

- 8 - 5/8" Lock Nut
- 8 - 5/8" Flat Washers

81052BAG

- 2 - 1/2" Flat Washer



2023 - 43630 N3 Kit Contents:

Kit Boxes Containing:

43630992:

- 1 - 43430BAG2
- 1 - 81052BAG
- 1 - Pass. Brake Line Bracket
- 1 - Dr. Brake Line Bracket
- 2 - Radius Arm Drop Bracket
- 2 - Headlight Sensor Bracket

1502BOX2:

- 2 - 4" Blocks
- 4 - 5/8" x 3 1/8" x 13 1/2" U-Bolts
- 1 - 5/8BAG

7669 (Overload Models Only)

- 4 - 5/8" x 3 5/8" x 16" U-Bolts

50220BOX1:

- 1 - Track Bar Bracket
- 4 - 5/8" x 3 5/8" x 13 1/2" U-Bolts
- 1 - 5/8BAG
- 1 - 50220BAG

760839

- V2 Front Shock Pair

760804

- V2 Rear Shock Pair

9461

- Front 3" Coil Pair

Kit Bags Containing:

43430BAG2:

- 2 - 18mm Lock Nut
- 4 - 18mm Flat Washer
- 2 - 18mm x 130mm Bolt
- 2 - 7/16" x 1 1/4" Bolt
- 2 - 7/16" Lock Nut
- 4 - 7/16" Flat Washer
- 2 - 3/8" Flanged Lock Nut
- 2 - 3/8" x 1 1/4" Bolt
- 2 - 3/8" Flat Washer
- 2 - Sleeve
- 4 - 5/16" x 1" Bolt
- 4 - 5/16" Flanged Lock Nut
- 4 - 5/16" Flat Washer
- 2 - #10 x 5/8" Button Head Bolt
- 2 - #10 Lock Nut

1502BAG2:

- 2-14mm x 130mm Bolts

50220BAG:

- 2 - 3" Cam Plate

5/8BAG x 2:

- 8 - 5/8" Lock Nut
- 8 - 5/8" Flat Washers

81052BAG

- 2 - 1/2" Flat Washer



Kit Picture



FRONT INSTALLATION INSTRUCTIONS

1. Jack up the front of the vehicle and support with jack stands on the frame rail.
2. Remove the front wheels and tires. Support the axle with a floor jack.
3. Remove the stock shock absorber from the upper mount using a 19mm wrench and the lower mount using a 18mm wrench. Retain the lower shock mounting bolt for reuse.
4. Remove the track bar from the frame as shown in **Photo 1** using a 21mm and 30mm socket / wrench and retain the factory hardware. Remove the factory track rod bracket using a 21mm socket and install the new track rod bracket in the factory location using the factory hardware. **See Photo 2.** Torque to 120 ft-lbs. using a 21mm socket.
6. Remove lower sway bar nut on the axle using a 21mm wrench to allow the axle to move downward for the installa-

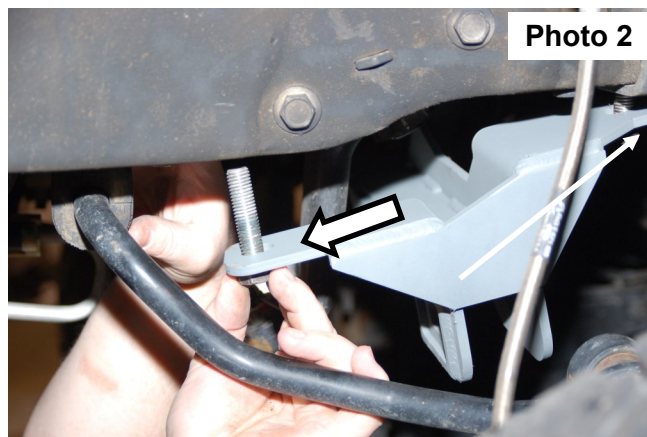
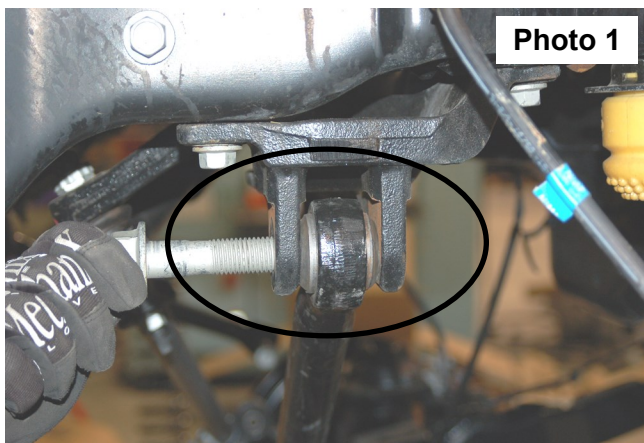

- tion of the new coil.
7. Using the floor jack, lower the axle to allow for the coil spring to be removed from the coil mount. Take notice of the position of the coil wraps on the top and bottom spring in the mount. The coil will be reinstalled in the same position. **See Photo 3.**
 8. Remove the brake line bracket using a 10mm wrench.
 9. Use a 24mm socket and 1 1/16" wrench to remove the radius arm bolts. Drop the radius arms from the frame. Retain hardware for reuse. **See Photo 4**

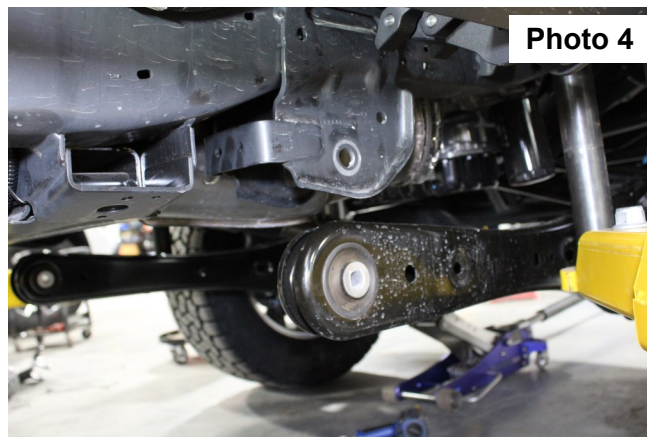

10. Install the 18mm x 130mm bolt, two 18mm washers, 18mm lock nut and sleeve from 43430BAG1 into the middle hole of the radius arm drop bracket with a 1 1/16" wrench. Torque to spec. **See Photo 5.**
11. Install a 7/16" x 1 1/4" bolt, washers, and lock nut from 43430BAG1 in the top outer hole of the drop bracket with a 5/8" wrench. Torque to spec. **See Photo 6.**

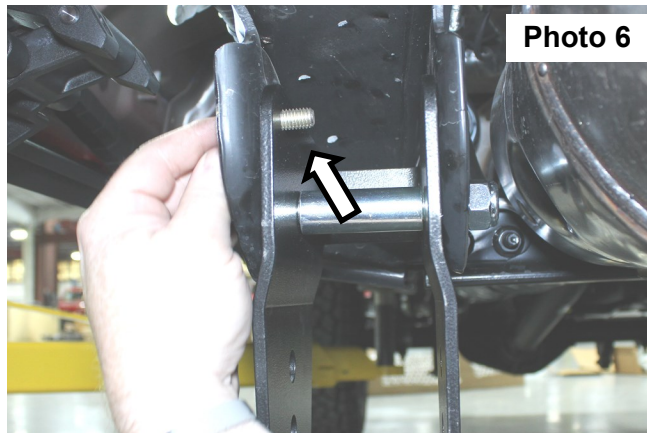
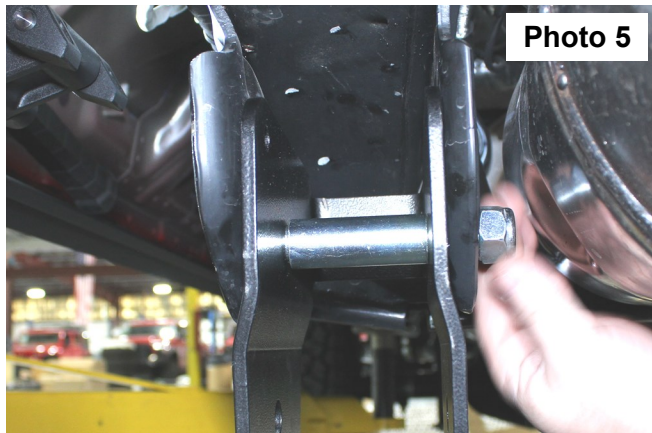

12. Install a 3/8" x 1 1/4" bolt, washers, and lock nut from 43430BAG1 in the top inner hole of the drop bracket with a 9/16" wrench. Torque to spec. **See Photo 7.**
13. Install two sets of 5/16" x 1" bolts, washers, and lock nuts into the rear of the radius arm drip bracket with a 9/16" wrench. Torque to spec. **See Photo 8.**

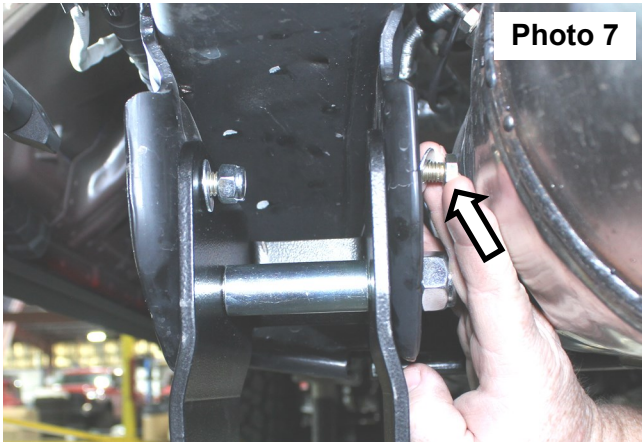

Photo 7

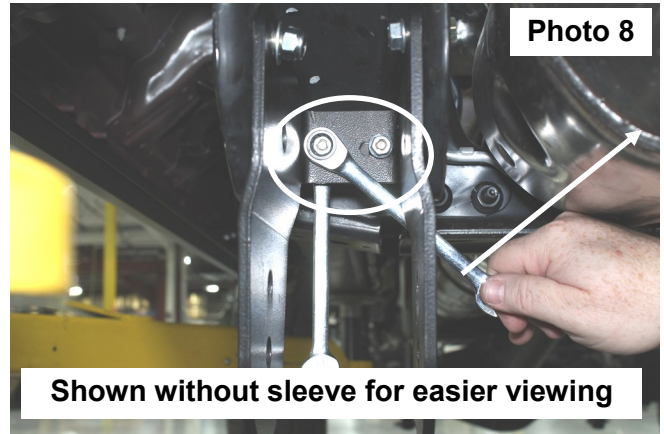

Photo 8

Shown without sleeve for easier viewing

14. When installing the driver side radius arm drop bracket, use a clip tool to remove the ABS wiring harness to gain access to the rear bolts of the drop bracket. Reinstall harness after installing the 5/16" bolts. **See Photo 9.**
15. Reinstall the stock radius arm into the new bracket in the upper hole with stock hardware. Do not tighten the radius arm to the bracket at this time. **See Photo 10.**

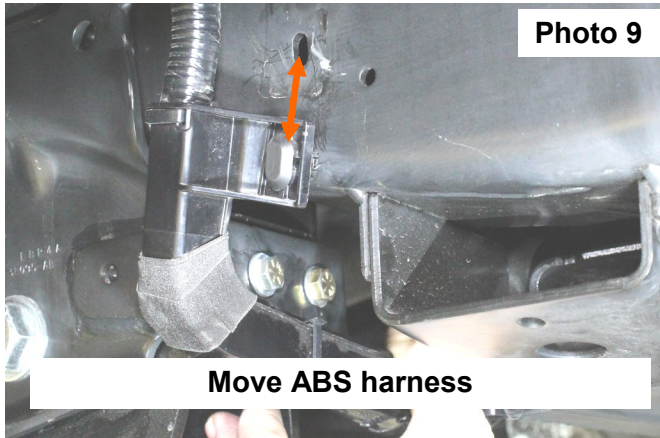

Photo 9

Move ABS harness

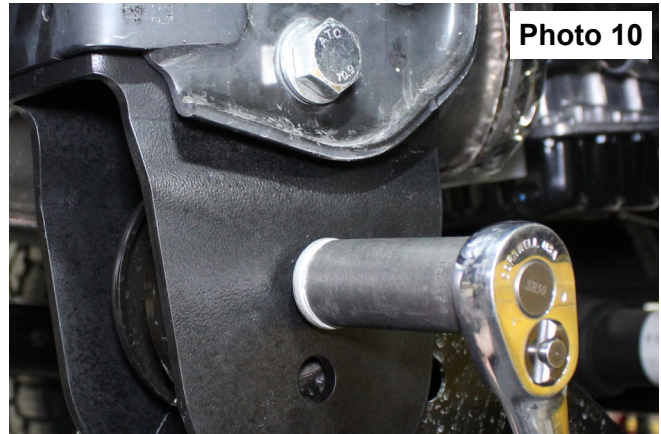

Photo 10

16. Lower the front axle some to give room for the new spring. Install the new coil spring and then slightly compress the spring with the floor jack. Reinstall the factory sway bar nut using a 21mm wrench and socket. **See Photo 11.**
17. Using the factory hardware, install the supplied brake line relocation bracket on the coil seat. Torque to spec with a 13mm wrench. **See Photo 12.**

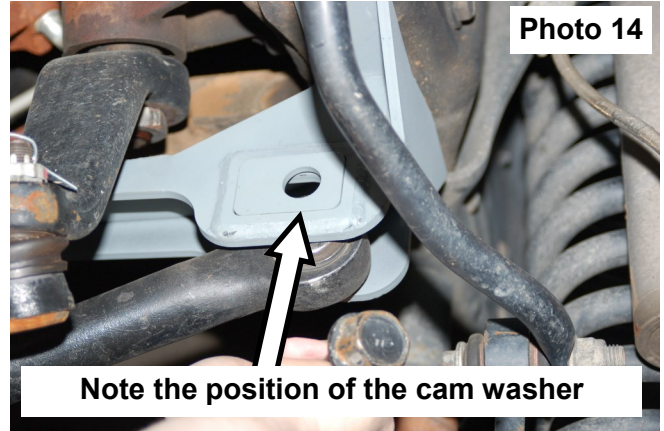
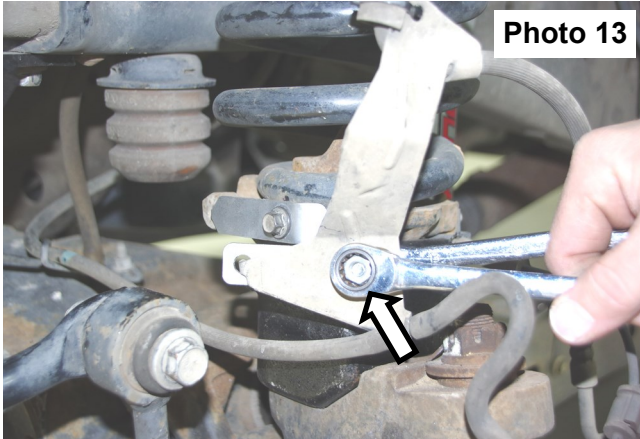

Photo 11



Photo 12

18. Install the factory brake line bracket on the supplied relocation bracket using the supplied 5/16" x 3/4" bolt, washer, and flange nut. Torque to spec with a 1/2" wrench and socket. **See Photo 13.**
19. Install the new front shock **660839**. Use factory hardware on the lower mount and use the supplied bushing kit on the upper mount. Torque the lower bolt to spec with an 18mm socket. Tighten the top until the bushing bulges with a 19mm wrench.
20. Install the wheels/tires. Jack up the vehicle and remove the jack stands. Lower the vehicle to the ground.
21. Position the cam washer as shown in **Photo 14** and swing up the frame end of the track rod. Install the frame mount using the stock hardware. Torque to spec with a 30mm socket and wrench. **NOTE:** It may be necessary to have another person turn the vehicle as it sits still to align the track rod with the mount.
22. Torque the radius arm in the new bracket to spec using a 24mm socket and 1 1/16" wrench.



HEADLIGHT SENSOR BRACKET

1. Remove factory ride height sensor hardware with a 1/8" Allen wrench.
2. Attach the sensor bracket to the factory bracket using the supplied #10 hardware. Tighten with a 1/8" Allen wrench.
3. Re-use the factory ballstud to match the current lift kit on the vehicle. **See Photo 1.**

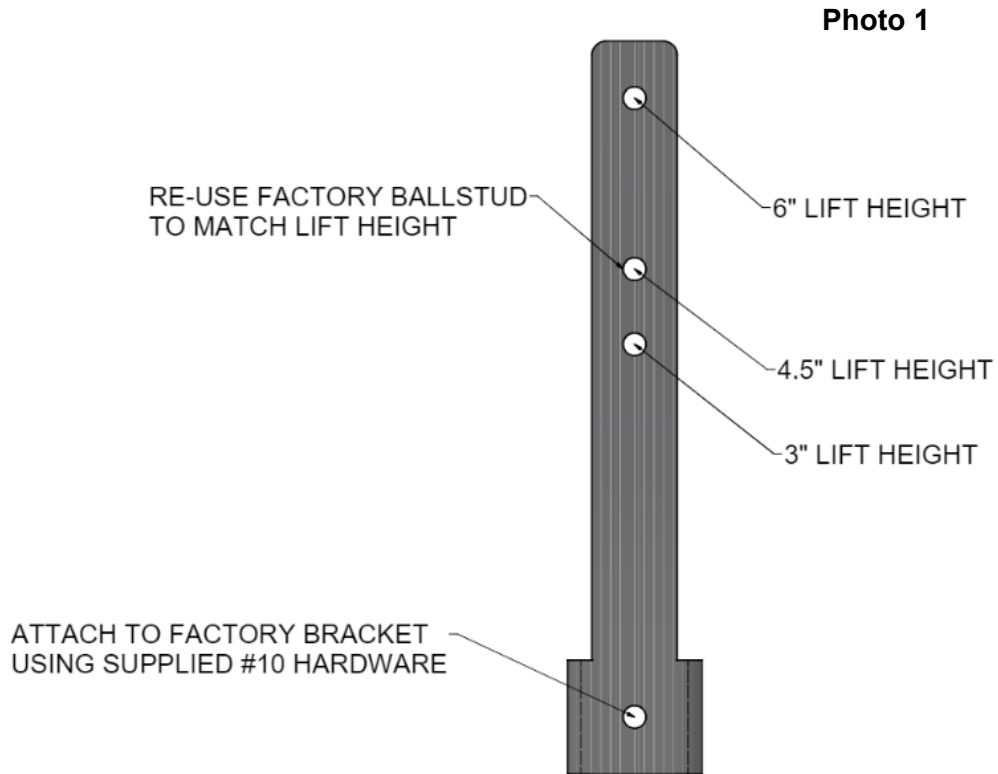

REAR INSTALLATION

1. Chock front wheels and jack up the rear of the vehicle. Secure with jack stands on the frame rail.
2. Place a floor jack under the rear differential. Using a 18mm wrench for the upper, and 19mm and 15mm wrench for the lower, remove the stock shock absorbers, retain the stock hardware for reuse.
3. Remove the stock U-bolts using a 24mm socket. Use the floor jack to lower the axle assembly to allow for the lifted block installation
4. Install the Rough Country block in between the leaf spring pack and the axle. The block being installed has a taper, the short end of the block should be towards the center of the truck. **Photo 1** shows proper block placement. Jack up the axle and align the pins in the blocks and axle seat.
5. **Only install the 4" block, the stock block will not be used.**
6. Secure with the new U-bolts and torque evenly to 120ft lbs using a 24mm socket using a "X" pattern. **NOTE:** Models with the overload springs will need the 16" U-bolts.
7. Locate shock number **660804**. Install using factory mounting pin on upper and factory bolt on lower shock mount. Tighten using a 18mm wrench for the upper and a 18mm & 15mm wrench for the bottom.
8. Install the wheels and tires. Jack up the vehicle with the floor jack to remove the jack stands.
9. Lower the vehicle to the floor.

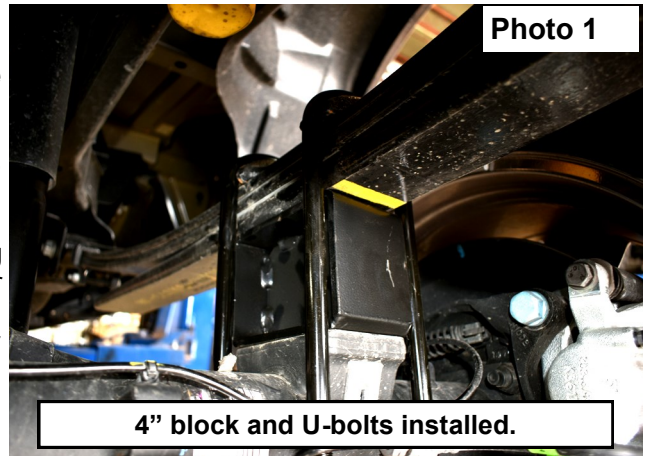

POST INSTALLATION INSTRUCTIONS

1. Check all fasteners for proper torque. Check to ensure there is adequate clearance between all rotating, mobile, fixed and heated members. Check steering gear for interference and proper working order. Test brake system
2. Perform steering sweep. Check to ensure brake hoses have sufficient slack and will not contact rotating, mobile, or fixed members, adjust lines/brackets to eliminate interference and maintain proper working order. Failure to perform inspections may result in component failure
3. Readjust headlights to factory settings
4. Have vehicle aligned by a certified alignment professional.
5. All components must be retightened after 500 miles, and every three thousand miles after installation



By purchasing any item sold by Rough Country, LLC, the buyer expressly warrants that he/she is in compliance with all applicable Federal, State, and Local laws and regulations regarding the purchase, ownership, and use of the item. It shall be the buyers responsibility to comply with all Federal, State and Local laws governing the sales of any items listed, illustrated or sold. The buyer expressly agrees to indemnify and hold harmless Rough Country, LLC for all claims resulting directly or indirectly from the purchase, ownership, or use of the items.

