

# KAMPALA CAPITAL CITY AUTHORITY

PUBLIC HEALTH AND ENVIRONMENT DIRECTORATE

## MINIMUM STANDARDS FOR ONSITE SANITATION TECHNOLOGY OPTIONS IN KAMPALA

### SECOND EDITION

These standards were developed by the Directorate for Public Health and Environment KCCA in a consultative manner with inputs from user communities, various KCCA Directorates, Uganda National Action on Physical Disability (UNAPD), and other relevant stakeholders. All reasonable precautions were taken to ensure the accuracy of information contained in this document.

#### Supported by:



Schweizerische Eidgenossenschaft  
Confédération suisse  
Confederazione Svizzera  
Confederaziun svizra

Swiss Agency for Development  
and Cooperation SDC



**giz** Deutsche Gesellschaft  
für Internationale  
Zusammenarbeit (GIZ) GmbH



## TABLE OF CONTENTS

LIST OF ACRONYMS.....	iii
PREFACE.....	v
1 MINIMUM STANDARDS – THE BASIS .....	1
1.1 POLICY PROVISIONS .....	1
1.2 GENERAL REQUIREMENTS .....	2
1.3 PROVISIONS FOR PEOPLE WITH DISABILITY (PWDs).....	2
1.4 CONSTRUCTION SPECIFICATIONS.....	2
1.5 OPERATION AND MAINTENANCE REQUIREMENTS .....	2
1.6 MENU OF SANITATION OPTIONS .....	3
2 HOUSEHOLD TOILETS .....	4
2.1 GENERAL REQUIREMENTS .....	4
2.2 SELECTION GUIDE .....	4
2.3 STANDARDS FOR DIFFERENT TOILET OPTIONS .....	6
2.3.1 Cistern Flush Toilets.....	6
2.3.2 Pour Flush Toilets .....	7
2.3.3 Lined Ventilated Improved pit latrine (VIP).....	9
2.3.4 Precast VIP latrine.....	10
2.3.5 Cistern/Pour flush Toilet connected to a lined pit.....	11
2.3.6 Urine Diversion Dry Toilet (UDDT).....	12
3 PUBLIC AND INSTITUTIONAL TOILETS .....	14
3.1 GENERAL REQUIREMENTS .....	14
3.2 SELECTION GUIDE .....	14
3.3 STANDARDS FOR DIFFERENT TOILET OPTIONS .....	15
3.3.1 School Water Closets/Flushing toilets .....	15
3.3.2 Bio-Latrine for institutions .....	16
3.3.3 Public Water Closets/Flushing toilets.....	17
3.3.4 Portable/Mobile Toilets (Mobilets).....	19
4 ADD-ONS AND KEY TOILET ACCESSORIES .....	20
4.1 UDDT User Interfaces.....	20
4.2 Urinals .....	20
4.3 Containment/disposal .....	22
4.3.1 Septic Tank .....	22
4.3.2 Anaerobic Baffled Reactor.....	23
4.3.3 Grease trap and Grease Interceptor Tank .....	24
4.3.4 Soak pit .....	25
4.3.5 Drainage field .....	26
4.4 Handwashing facilities .....	26
4.5 Incinerator.....	28
BIBLIOGRAPHY .....	29
APPENDIX A1: SAMPLE DETAILED ENGINEERING DRAWINGS.....	30
APPENDIX A2: INDICATIVE TECHNOLOGY COSTS.....	31

## LIST OF TABLES

<b>Table 1-1:</b> Menu of sanitation technology options .....	3
<b>Table 3-1:</b> Public toilet urinal ratios .....	17

## LIST OF FIGURES

<b>Figure 2-1:</b> Household toilet selection guide .....	5
<b>Figure 2-2:</b> Cistern flush toilet options .....	6
<b>Figure 2-3:</b> Pour flush toilet options .....	8
<b>Figure 2-4:</b> Ventilated Improved Pit Latrine .....	10
<b>Figure 2-5:</b> Precast Concrete VIP latrine .....	11
<b>Figure 2-6:</b> Cistern flush toilet connected to a lined pit .....	12
<b>Figure 2-7:</b> Urine Diversion Dry Toilet (UDDT) .....	13
<b>Figure 3-1:</b> Public and Institutional toilet selection guide .....	15
<b>Figure 3-2:</b> School flushing toilets .....	16
<b>Figure 3-3:</b> Bio-toilet for Institutions .....	17
<b>Figure 3-4:</b> Public Toilets .....	18
<b>Figure 3-5:</b> Portable toilet .....	19
<b>Figure 4-1:</b> Urine Diversion Dry Toilet user interfaces .....	20
<b>Figure 4-2:</b> Wall mounted urinals .....	21
<b>Figure 4-3:</b> Trough urinal .....	21
<b>Figure 4-4:</b> Septic Tank Containment .....	23
<b>Figure 4-5:</b> Anaerobic Baffled Reactor (ABR) .....	24
<b>Figure 4-6:</b> Grease trap (left) and grease interceptor tank (right) .....	24
<b>Figure 4-7:</b> Gravel filled soak pit .....	25
<b>Figure 4-8:</b> Different handwashing facilities .....	27
<b>Figure 4-9:</b> Different handwashing facilities .....	28

## LIST OF ACRONYMS

C&T	Collection and transport
CSOs	Civil Society Organisations
FGDs	Focus group discussions
FS	Faecal sludge
FSM	Faecal sludge management
GIZ	Deutsche Gesellschaft für Internationale Zusammenarbeit
HH	Household
HWF	Hand washing facility
KCCA	Kampala Capital City Authority
MCA	Multi-criteria analysis
NEMA	National Environment Management Authority
NGO	Non-governmental organisation
O & M	Operation and maintenance
PWD	People with disabilities
RRR	Resource Recovery and Safe Reuse
RUWASS	Reform of the Urban Water and Sanitation Sector
SDGs	Sustainable Development Goals
UDDT	Urine Diversion Dehydrating Toilet
UNAPD	Uganda National Action on Physical Disability
VIP	Ventilated Improved Pit Latrine
WCs	Water closets
WHO	World Health Organisation
WSTF	Water Services Trust Fund

## CORE TECHNICAL TEAM

The following members directly contributed to the development of the second edition of the minimum standards for onsite sanitation technologies in Kampala.

<b>S/N</b>	<b>NAME OF MEMBERS</b>	<b>POSITION</b>	<b>INSTITUTION</b>
1.	Eng. Dr. Swaib Semiyaga	Main Consultant	Makerere University
2.	Eng. Fred Nuwagaba	Country Director, S4M	GIZ
3.	Ms. Faithful Atusinguza	Technical Advisor	GIZ
4.	Dr. Okello Ayen Daniel	Director, Public Health and Environment	Kampala Capital City Authority (KCCA)
5.	Dr. Najib B. Lukooya	Deputy Director, Public Health and Environment	KCCA
6.	Mr. Jude Byansi Zziwa	Manager waste and Sanitation	KCCA
7.	Mr. Richard Mutabazi	Supervisor Water and Sanitation	KCCA
8.	Eng. Allan Nkurunziza	Manager CWIS Program.	KCCA

## PREFACE

Availability of adequate sanitation services is one of the most significant development challenges experienced in the rapidly growing Kampala city. Over 90% of Kampala's population relies on on-site sanitation which include flush (pour and cistern) toilets, Urine Diversion Dehydrating Toilets (UDDTs), Ventilated Improved Pit Latrines (VIPs) and traditional pit latrines.

The toilets are put up by individuals and different institutions with no proper guidance to inform planning, construction and enforcement. Current practice involves relying on unguided previous experience to define what qualifies as an acceptable toilet facility. Legal provisions broadly define the requirement for a sanitation facility and some guidelines are inconsistent with each other. The Sustainable Development Goals (SDGs) define adequate sanitation to include safe excreta management and hand washing. Therefore, all toilets must have provisions for proper emptying and / or treatment of faecal sludge as well as a hand washing facility. In the absence of explicit legal provisions and consistent sanitation guidelines for, amongst others, the need for minimum standards is apparent.

Kampala Capital City Authority (KCCA)'s drive towards improving faecal sludge management (FSM) in Kampala presents the city sanitation challenges and significant contribution of sanitation to economic and social development of the country and thus its citizens. The Authority and its divisions have an intermediary function for the coordination of sanitation planning and the harmonisation with urban development planning. This document therefore is intended to assist households, developers and KCCA to define the minimum standards for onsite sanitation technology options that can be adopted in Kampala city. It will provide enforcement guidance to KCCA and assistance to improve FSM in the city.

These standards are derived from the provisions in existing legislation and guidelines related to sanitation in Uganda. They incorporate current FSM practices in the different KCCA divisions and best practice in similar contexts. Chapter 1 provides the basis and overview of the standards, chapter 2 and chapter 3 provide minimum standards for household and public/institutional onsite toilet options, respectively. Chapter 4 focuses on details relevant to add-ons like septic tanks and toilet accessories. Annexes with technical details of the different options and indicative costs form the last section of the document.

This second edition will continue to serve as a guiding document that will continually be refined basing on different field-users and/ or stakeholder experiences. It is important to note that these minimum standards should be read in conjunction with available technical standards of building construction, operation and maintenance guides as well as legal requirements in Uganda relating to sanitation, physical planning, environment protection and engineering works.

**In the absence of explicit legal provisions and consistent sanitation guidelines, the need for minimum standards is apparent.**

# 1 MINIMUM STANDARDS – THE BASIS

## 1.1 POLICY PROVISIONS

Law/regulation	Provisions relevant to on-site sanitation
Public Health Act 1935 (Cap.281) (Revised in 2000)	<ul style="list-style-type: none"> <li>• Mandates the Local Authority to safeguard and promote public health (Part II, Section 5).</li> <li>• Requires all dwellings to have functional sanitation facilities that meet minimum standards (Part X, Sections 84-86 and 88-89).</li> <li>• All buildings to be erected on plots with proper and sufficient access to a road or road reserve (S.I 281-1, Part III, 26-29).</li> <li>• KCCA is mandated to enforce rules in the Public Health Act (Part IX, 15).</li> </ul>
The Local Government Act 1997 (Cap.243)	<ul style="list-style-type: none"> <li>• Allows KCCA to implement and maintain public sanitation facilities, sanitary responsibility for the removal and disposal of night soil (Second Schedule, Part 3, 1 (o and w)).</li> <li>• Enables a Local Authority to make bye-laws for reinforcing existing laws (Part IV, Section 39-1).</li> <li>• Creates opportunities to regulate (e.g. setting operational standards) the FSM business through licensing.</li> </ul>
The National Environment (Waste Management) Regulations S.I. No 52/1999	<ul style="list-style-type: none"> <li>• Establishes NEMA as mandated institution for licensing persons intending to (i) transport waste (Clause 6, 1) and/or to operate a waste treatment plant or waste disposal site after an EIA study (Clause 13, 1).</li> <li>• Recognizes enforcement as a strategy to minimize public health risks and prevent environmental pollution</li> </ul>
The Kampala Capital City Act, 2010	<ul style="list-style-type: none"> <li>• Provides mandate for KCCA to ensure public health and safe sanitation in the communities (Part B, Section 35, 29 (l &amp; s)).</li> <li>• Allows KCCA to enforce ordinances and byelaws made by the Authority (Part III, 19 (s)).</li> <li>• Provides mandate for KCCA to set service delivery standards e.g. for pit latrine construction and emptying services.</li> <li>• Enables KCCA to control infrastructure development in the city.</li> </ul>
The Public Private Partnership Act, 2014	<ul style="list-style-type: none"> <li>• Enables private sector involvement in faecal sludge management (FSM) in Kampala city including through different private-public partnership arrangements.</li> </ul>
The Building Regulations Statutory Instruments 281-1, 2, 3.20	<ul style="list-style-type: none"> <li>• Provides for approval of drawings including plans and sections of buildings by the Local Authority (S.I. 281: 1-3).</li> <li>• Allows KCCA to enforce compliance by whoever is to erect a school (S.I. 281-20).</li> </ul>
The Physical Planning Act, 2010	<ul style="list-style-type: none"> <li>• Provides for the making and approval of physical development plans by the Local Authority and for the applications for development permission.</li> </ul>
National Physical Planning Standards and Guidelines, 2011 Building Control Regulations and Schedule 22	<ul style="list-style-type: none"> <li>• Provides guidelines on toilet and septic tank standards as well as planning guidelines for dwellings and public places.</li> <li>• Provides guidance on standards for sanitation technology options and latrine accommodation.</li> </ul>
The Kampala Capital City (Sewage and Faecal Sludge Management) Ordinance, 2019	<ul style="list-style-type: none"> <li>• Premises to have onsite sanitation facilities (Part II, Section 5(1))</li> <li>• Specifies requirements for onsite sanitation facilities (part II. Section 5 (2)).</li> </ul>

## 1.2 GENERAL REQUIREMENTS

Each on-site sanitation technology should:

- i. Be emptiable
- ii. Have a hand washing facility with soap
- iii. Have anal cleansing materials
- iv. Allow for privacy of users including having a lockable door
- v. Allow for inclusiveness e.g. provisions for people with disabilities (PWD) and for menstrual hygiene management
- vi. Have a durable and sturdy superstructure
- vii. Be secure – safety for night use and from intrusion
- viii. Be well ventilated and have adequate lighting especially for night use
- ix. Be kept clean and have adequate lighting especially for night use
- x. Have provision for access for pit emptying.

## 1.3 PROVISIONS FOR PEOPLE WITH DISABILITY (PWDs)

- i. Minimum room/stance floor dimensions – 1.5m by 1.5m
- ii. Door – minimum 0.9m wide with a pull handle for closing
- iii. Toilet seat height – 0.48m from finished floor surface
- iv. Hand rails - diameter of 32mm to 38mm fitted at back and wall next to toilet seat; upper rails at 0.84m to 0.92m height and lower rails at 0.55m
- v. Two separate sinks at different heights – high sink at 0.8m and low sink at 0.4m
- vi. Urinals floor surface - 1.5m x 0.8m to allow wheel chair approach

## 1.4 CONSTRUCTION SPECIFICATIONS

- i. Mortar (mix of cement and sand) - Minimum mix ratio of 1:4
- ii. Concrete – Minimum mix ratio of 1:3:6 (cement: sand: aggregates)
- iii. Superstructure walling – Burnt bricks with 150mm minimum thickness
- iv. Pit lining and substructure walling – Burnt bricks with 200mm thickness (header bond)

## 1.5 OPERATION AND MAINTENANCE REQUIREMENTS

Operation and maintenance should follow standard sanitation and asset management practice in line with KCCA O&M guidelines as well as other existing national provisions, such as the Ministry of Education and Sports Handbook for Operation and Maintenance of Water, Sanitation and Hygiene Facilities in Schools in Uganda. Key provisions include: daily cleaning of facility, immediate repair to structures, safe operation in line with guidelines for each sanitation option.



## 1.6 MENU OF SANITATION OPTIONS

The technology options presented in this guideline are mainly limited to containment (Table 1-1).

**Table 1-1:** Menu of sanitation technology options

Sanitation technology category	Component Technologies	Brief description
Water borne toilets	<ul style="list-style-type: none"> <li>a. Cistern flush</li> <li>b. Pour flush toilet</li> <li>c. Septic tank</li> <li>d. Anaerobic baffled reactor</li> <li>e. Soak pit</li> </ul>	<p>Water closets (WCs) use water to transport human excreta through a drainpipe either to a sewer for offsite treatment or to a septic tank/anaerobic baffled reactor (ABR)/a bio-treatment unit for onsite treatment. A typical water borne toilet comprises a superstructure, toilet pans, flushing system, vent pipes, manholes for connecting drainage pipes at junctions and bends and a connection to a conveyance or treatment system. In public places, the squatting option and pedal flushing system are preferred to minimize disease transmission and also for ease of cleaning.</p> <p>Cistern flush use 3 to 15 litres of water per flush while pour flush uses 1.5 to 3 litres.</p>
Lined latrines	<ul style="list-style-type: none"> <li>a. Ventilated Improved Pit latrine (VIP)</li> <li>b. Elevated latrine</li> <li>c. Precast VIP latrine</li> <li>d. Pour flush to a lined pit</li> </ul>	<p>This comprise a pit for containment of faecal sludge and a vent pipe that serves to prevent flies and odor from the pit. Pits are lined to prevent contamination of ground water and allow for emptying the pit when full. The main features of a lined VIP are: a superstructure, lined substructure or pit, vent pipe, slab and access provision for pit emptying.</p> <p>This option is limited household level only.</p>
Urine Diversion Dry Toilets (UDDTs)		<p>A Urine Diverting Dry Toilet (UDDT) is an ecological sanitation toilet option which involves separation of urine from faeces and operates on principle of waste sanitization for re-use. UDDTs are only recommended for use by households because of the operation and maintenance requirements. A typical UDDT consists of:</p> <p>A toilet superstructure, toilet seat or squatting pan, two collection chambers for double vault systems, a ventilation pipe to aerate the collection chamber and a urine pipe connected to a soakaway or a collection container.</p>
Bio-latrines		<p>Bio-latrines are a form of water borne toilet that promotes resource recovery and reuse as the toilet block is connected to anaerobic digesters which produce biogas that can be used for lighting and cooking. In addition, the digestate can be used as a soil conditioner. The main features of bio-latrines are: toilet block, bio-digester chamber, expansion chamber, slurry collection tank and gas tapping unit.</p> <p>Currently bio-toilets are being promoted at schools, given the high FS generation rates and demand for cooking energy.</p>
Prefabricated Integrated Treatment Units	To conform to ISO 30500:2018	<p>Provision for Non-Sewered Sanitation systems (NSSS) which range from urinals, toilet pans, dry toilets to novel evacuation mechanisms such as those employing mechanical forces requiring little to no water. Conventional and novel evacuation mechanisms may be combined with urine diversion applications (e.g. urine diversion flush toilet, urine diversion dry toilet). Backend treatment technologies and processes of NSSS range from biological or chemical to physical unit processes (e.g. anaerobic and aerobic digestion, combustion and membranes).</p>

## 2 HOUSEHOLD TOILETS

### 2.1 GENERAL REQUIREMENTS

- i. A single facility can be located inhouse or outdoors.
- ii. Inhouse facilities are only limited to cistern/pour flush toilets.
- iii. An inhouse facility should not be entered directly from the area of food preparation and a habitable room except a bedroom.
- iv. A shared facility can have multiple stances, with each stance limited to a maximum of 4 households.
- v. Connection of sinks, showers and toilets through a drainage trap to drainage system.
- vi. Greywater from the kitchen should be connected to discharge system or septic tank via a grease trap.
- vii. Septic tanks must be positioned so that they are accessible for emptying by trucks
- viii. Superstructure can be built from permanent materials or any other whose performance has been approved by authority.
- ix. Smooth finish for floor and walls of the superstructure
- x. Where applicable, allow support rails and ramp for PWDs
- xi. Provide holder or container for anal cleansing material
- xii. Provide container for MHM
- xiii. Discharge drain pipes of minimum 100 mm (4 inches)

### 2.2 SELECTION GUIDE

The selection of appropriate sanitation technological options is often an iterative process involving multi-criteria analysis of key composite factors either through multi-stakeholder engagements, computer aided systems and or expert opinions. Key factors influencing the decision on options to adapt include:

- i. socio-cultural including acceptability, perception, and usability,
- ii. environmental related to pollution and pathogen risk,
- iii. socio-economic – number of users, affordability and resource optimization/re-use,
- iv. physical environment including ground/soil conditions, ground water table levels and available land area,
- v. physical development of an area, and
- vi. water availability and service levels.

This minimum standard adopts three basic key criteria in the proposed simplified decision support framework (Figure 2-1) for minimum on-site containment technology options. These include availability of water supply, water table level and ground conditions. The menu of options for household toilets includes the cistern flush toilet, pour flush toilet, Lined Latrines and Urine Diversion Dry Toilet (UDDT).

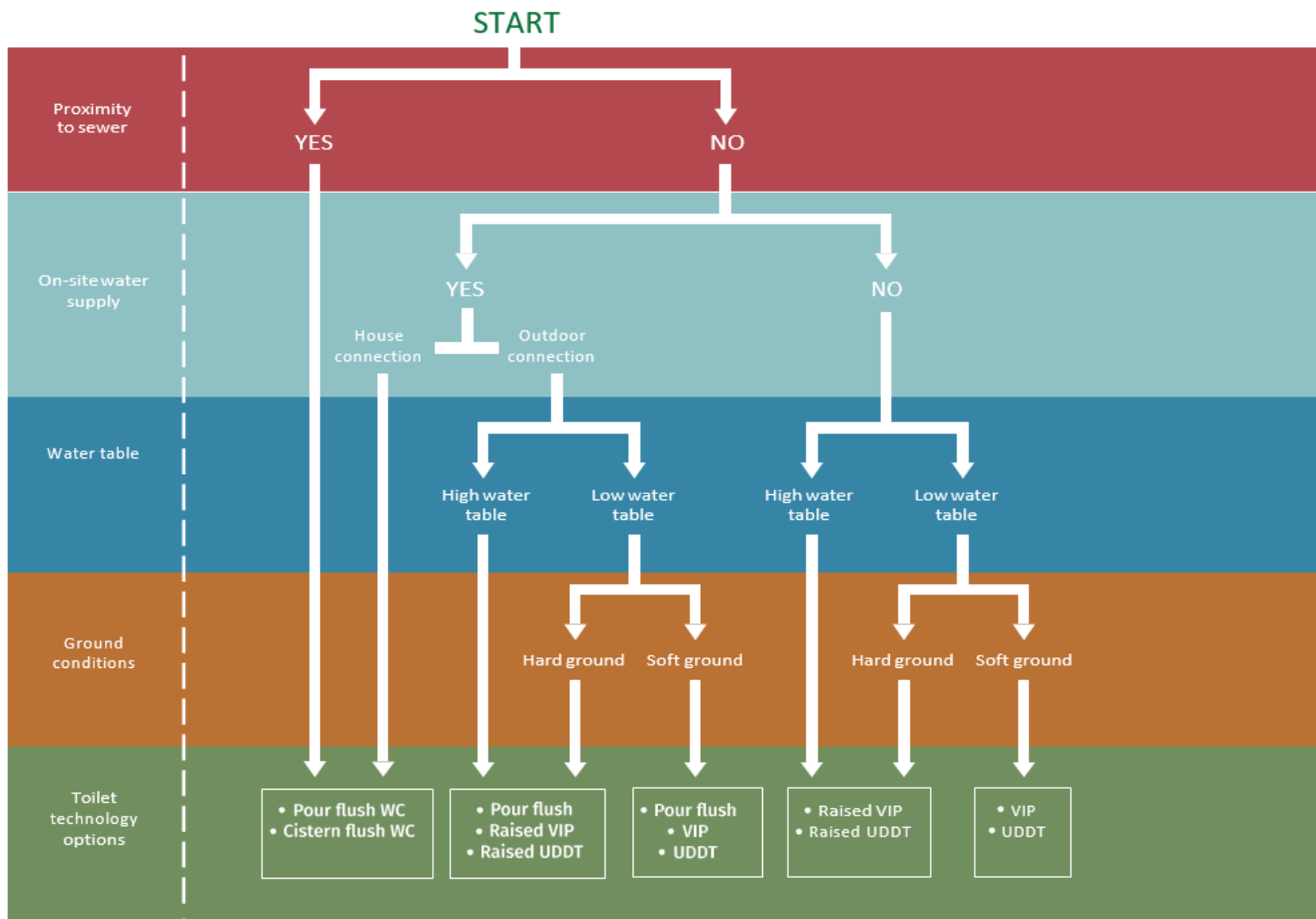

**Figure 2-1:** Household toilet selection guide

## 2.3 STANDARDS FOR DIFFERENT TOILET OPTIONS

### 2.3.1 Cistern Flush Toilets

#### Key Minimum Standards

- i. Room/floor dimensions: 1.0m x 1.5m (internal dimensions).
- ii. Connection to water supply system – minimum 10 liters per person per day for flushing.
- iii. Light provision for night use.
- iv. Holder or container for anal cleansing material.
- v. Discharge to sewer, septic tank or emptiable lined pit.

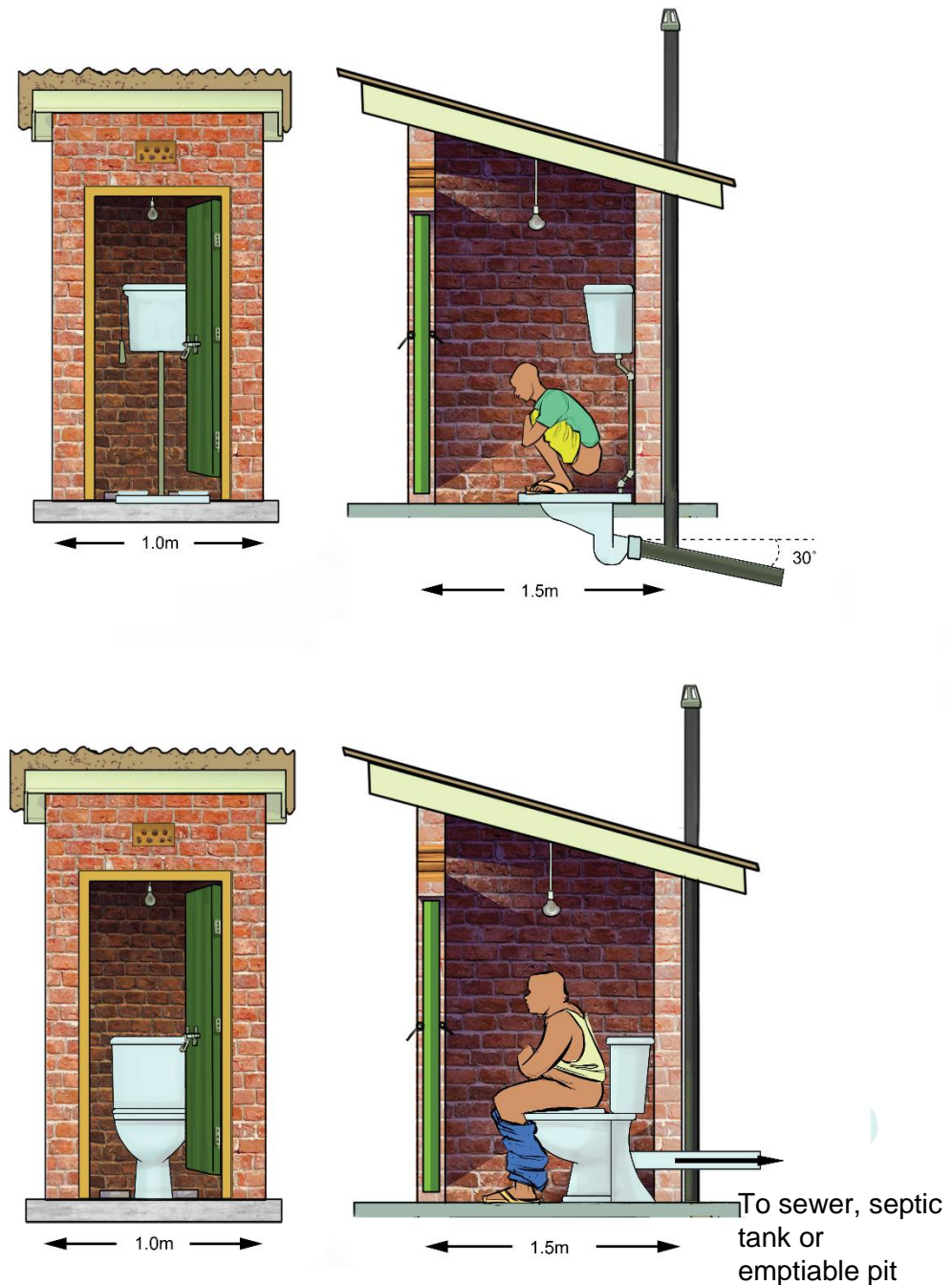
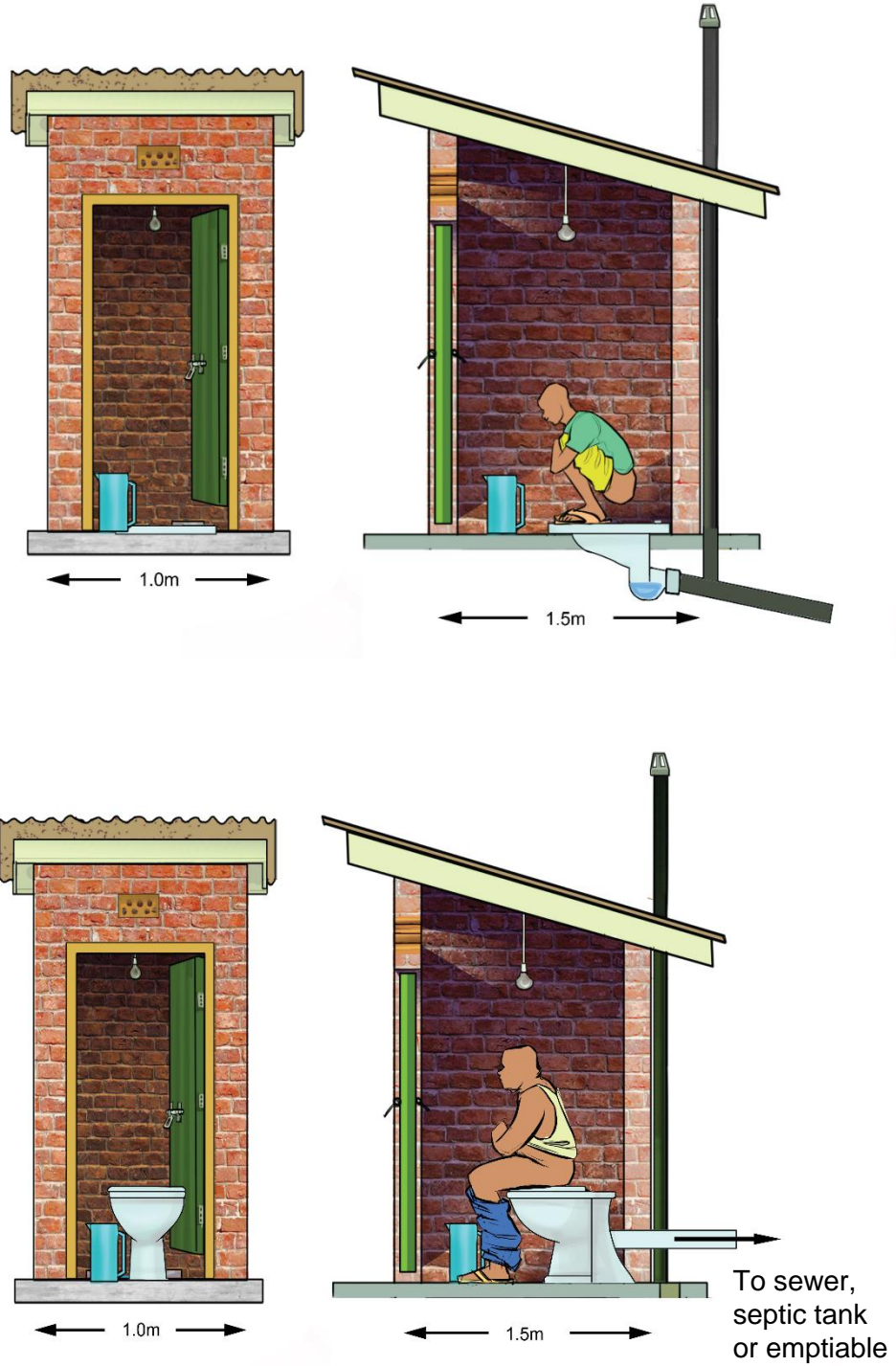

Figure 2-2: Cistern flush toilet options

### 2.3.2 Pour Flush Toilets

#### Key Minimum Standards

- i. Room: 1.0m x 1.5m (internal dimensions).
- ii. Flushing water - 1.5 liters of water per person per day.
- iii. Pan/ bowl:
  - Dimensions: 450mm long and 200mm wide
  - Shape: oval or pear-shaped.
  - Rear outlet with 25 – 30 degrees bottom slope towards the back.
  - Water seal depth of minimum of 20mm and an outlet pipe of a minimum 70mm diameter.
  - Discharge pipe: minimum 100mm diameter fitted at a slope of 1:30 to be self-cleaning
- iv. Light provision for night use.
- v. Holder or container for anal cleansing material
- vi. Discharge to sewer, septic tank or emptiable lined pit.

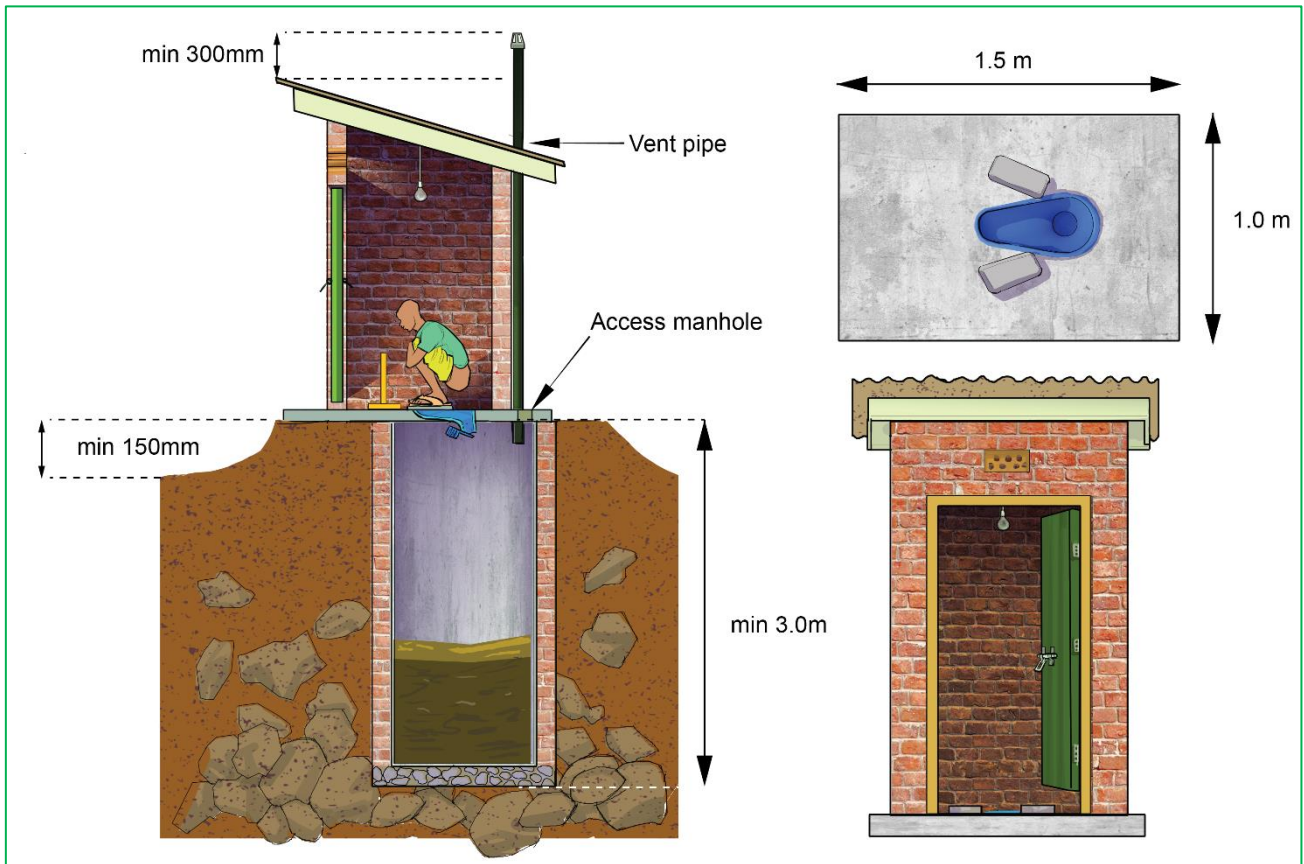

**Figure 2-3:** Pour flush toilet options

### 2.3.3 Lined Ventilated Improved pit latrine (VIP)

#### Key Minimum Standards

- i. Limited to only household level in Kampala
- ii. Location:
  - Minimum distance of 10m from any habitable room/kitchen/food stores.
  - Minimum distance of 1.5m from any plot boundary.
- iii. A stance to user ratio of maximum 1:5
- iv. Superstructure/room:
  - Floor internal dimensions: 1.0m x 1.5m
  - Height: 2.15m from the floor to underside of ceiling
  - Burnt brick walling: flush pointed internal and external finishes
  - Door raised (50mm) from the floor to allow in air
- v. Slab: reinforced 50mm thick concrete
- vi. Floor level shall be at least 150mm above the surrounding ground level.
- vii. Drop hole: not larger than 250mm at largest opening (for child safety)
- viii. Squat hole cover to help control flies and odour
- ix. Light for night use
- x. Holder or container for anal cleansing material
- xi. Lined pit to prevent groundwater contamination:
  - Fully lined e.g. with burnt bricks.
  - Minimum internal effective depth of 3.0m and width of 1.2m of the lined pit
  - Bottom should be at least 1.5m above the water table
- xii. Vent pipe:
  - Diameter at least 110mm.
  - Top end at least 300mm above the highest part of the roof to maximize wind into system.
  - Fly screen (mesh) at top of vent pipe with openings/holes not larger than 1.5mm square. Mesh material should be corrosion, rain, heat and sunlight resistant
  - Connection to slab should be completely sealed to minimize leakage
- xiii. Access to facilitate pit emptying services
- xiv. Pit should be emptied when contents are within 0.5 m of the soffit (underside) of the cover slab



**Figure 2-4:** Ventilated Improved Pit Latrine

### 2.3.4 Precast VIP latrine

Prefabrication of components (substructure, superstructure and roof) can be a promising option for cost reduction as it can offer economies of scale. Moreover, prefabrication can be a way to control the material quality and reduce wastage. Examples include concrete rings (culverts) for lining the pits, concrete panels for the outer walls of the superstructure or prefab squat pans or toilet seats out of cement or plastic and user interface products such as the SaTo pan and saniplats.

#### Key Minimum Standards

- i. Stated standards for lined VIP latrine apply
- ii. Floor internal dimensions: min 1.0m x 1.0m for a stance with one door
- iii. Superstructure materials: Plasticised material, bricks aluminium/galvanised sheets, ferrocement/precast concrete.
- iv. Pit lining materials: concrete rings, burnt bricks.





**Figure 2-5:** Precast Concrete VIP latrine

### 2.3.5 Cistern/Pour flush Toilet connected to a lined pit

This is an option with a superstructure and an offset or in-place lined pit.

#### Key Minimum Standards

- i. A toilet can be located inhouse while a lined pit is outdoors
- ii. Lined pit to prevent groundwater contamination:
  - Fully lined e.g. with burnt bricks or concrete rings
  - Minimum internal effective depth of 3.0m
- iii. Superstructure/room:
  - Floor internal dimensions: 1.0m x 1.5m
  - Height: 2.15m from the floor to underside of ceiling.
  - Burnt brick walling: flush pointed internal and external finishes.
  - Door raised (50mm) from the floor to allow in air.
- iv. Access to facilitate pit emptying services.
- v. Pit should be emptied when contents are full.

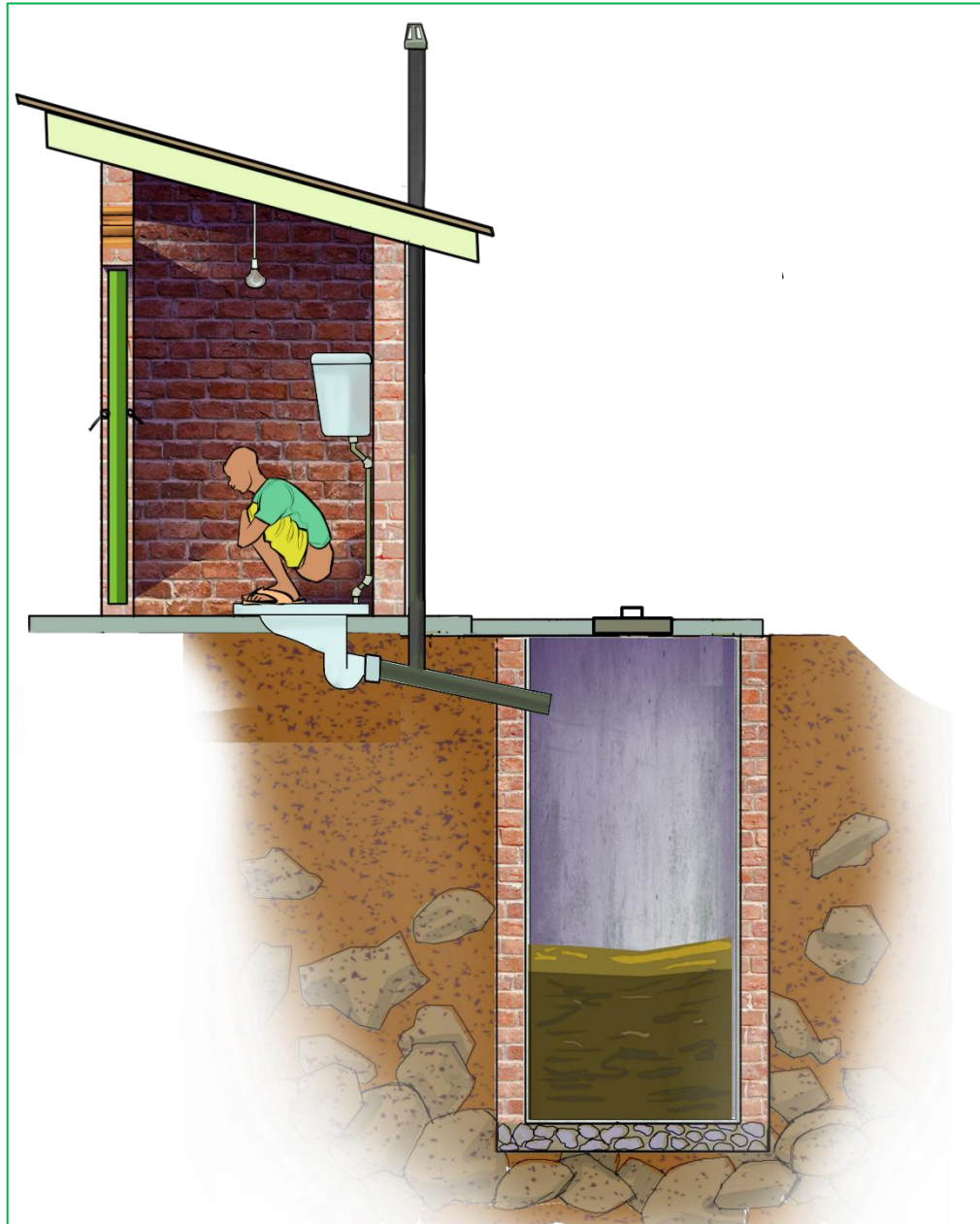

**Figure 2-6:** Cistern flush toilet connected to a lined pit

### 2.3.6 Urine Diversion Dry Toilet (UDDT)

This is a household toilet option that applies to areas with high water tables and firm/rocky ground as well as where urban agriculture is favoured.

#### **Key Minimum Standards**

- i. Superstructure/room:
  - Floor internal dimensions: 1.0m x 1.5m for a double vault with one door
  - Height: 2.15 m from the floor to the underside of ceiling
  - Burnt brick walling: flush pointed internal and external finishes
- ii. Door raised 50mm from the floor to allow in air
- iii. Include container for storing ash

- iv. Light for night use
- v. Holder or container for anal cleansing material
- vi. Slab made of reinforced 50mm thick concrete
- vii. Piping to urine storage tanks should be:
  - installed with at least a 1% slope for proper urine flow
  - water tight to prevent wetting vault contents
  - kept as short as possible and sharp angles (90°) avoided to limit scaling.
- viii. Wash the bowl with a mild acid and/or hot water to prevent build-up of deposits and scaling
- ix. Vent pipe: same standards as for VIP latrine
- x. Vaults/ chambers:
  - two chambers facing direction of maximum sunshine
  - minimum floor dimensions of 750mm x 600mm
  - inclined (150) steel plate access door painted black for maximum heat retention
- xi. 6 months minimum sanitisation period for excreta before reuse
- xii. 1-month minimum sanitisation period for urine excreta before reuse.



**Figure 2-7:** Urine Diversion Dry Toilet (UDDT)

### 3 PUBLIC AND INSTITUTIONAL TOILETS

This section relates to toilets for public and institutional use. Public toilets relate to on-site sanitation options for public places such as markets, vehicle parks, recreational parks, offices, churches, mosques and commercial buildings (hotels, hostels, shopping malls and apartment blocks). On the other hand, institutional toilets include facilities used in health centres, prisons and schools (primary and secondary).

#### 3.1 GENERAL REQUIREMENTS

- i. All public and institutional buildings/places must have water borne toilet facilities drained to a septic tank/an anaerobic baffled reactor (ABR) and soak pit within the plot or connected to a sewer system.
- ii. Simple signage prominently displayed indicating EXIT, ENTRANCE, GENDER, as well as stances for PWD and ablution
- iii. Provisions for persons with disability with at least one stance reserved for each gender.
- iv. Separate toilet blocks for male and female
- v. Handwashing facility with soap on each toilet block side
- vi. Toilet areas for each gender should be separated by solid walls (not lightweight partitions) and should have separate entrances
- vii. Refuse bin in all toilets for females
- viii. Provision for at least 10 liters per person per day for conventional flushing toilets and at least 1.5 liters per person per day for pour flush toilets
- ix. Greywater from the kitchen of commercial or institutional buildings to be discharged through a grease interceptor tank
- x. For school toilets
  - Separate wash room for adolescent girls fitted with disposal or refuse bin and provision for water for cleansing
  - Ablution tap or container for schools with washer population of more than 50
  - One shower for 20 every users in boarding schools
  - An incinerator near facilities for girls

#### 3.2 SELECTION GUIDE

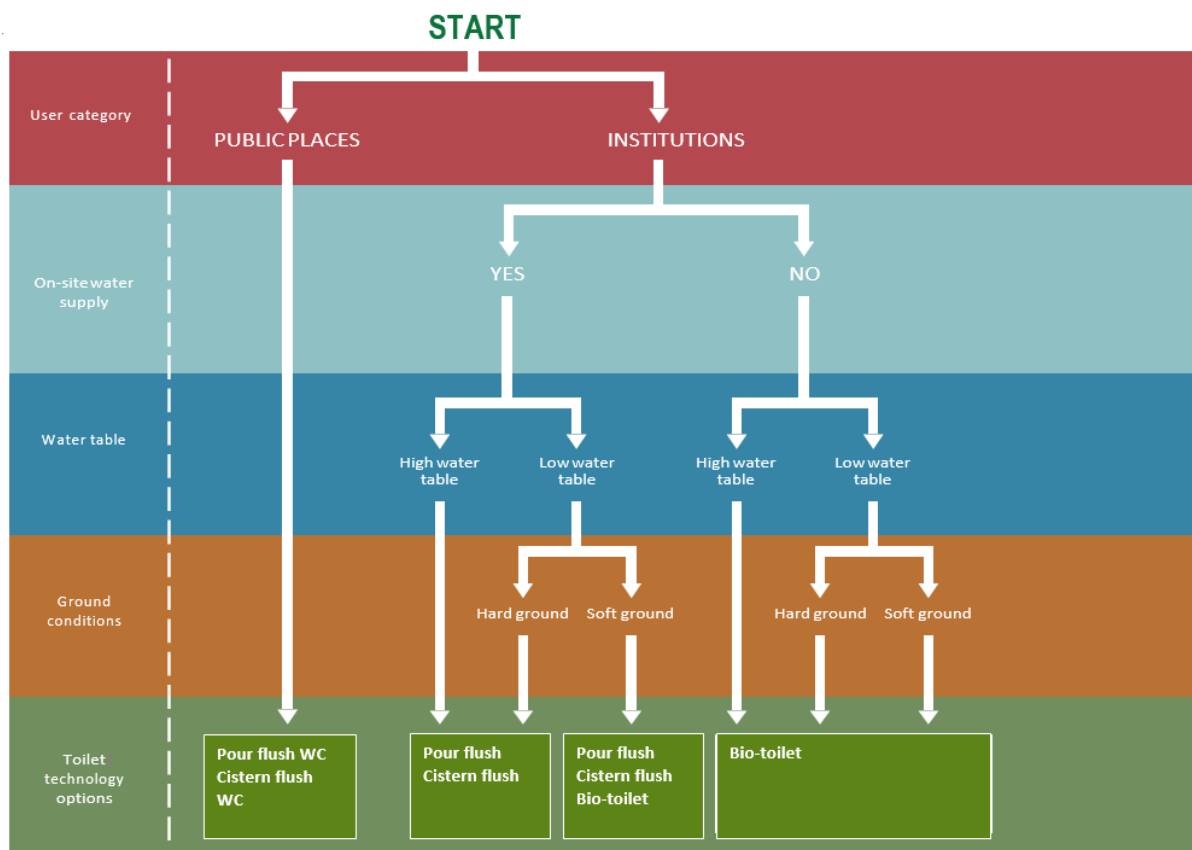

**Figure 3-1:** Public and Institutional toilet selection guide

### 3.3 STANDARDS FOR DIFFERENT TOILET OPTIONS

#### 3.3.1 School Water Closets/Flushing toilets

##### Key Minimum Standards

- i. Floor dimensions: 1.0m by 1.5m, and 1.8m by 1.8m for PWD stances
- ii. Separate stances for boys, girls and teachers
- iii. Holder or container for anal cleansing material
- iv. Hygienic to use and easy to clean
- v. 1 shower facility for girls with soap, water and basin
- vi. A hand washing facility with soap for each side (girls and boys)
- vii. At least a wheel chair disabled facility
- viii. Sufficient ventilation and lighting
- ix. Raised water storage tank with a capacity of at least 2500 litres
- x. Access road of minimum 4.0m width to facilitate septic tank emptying with a vacuum truck
- xi. Signage with visible and legible directions to toilet location
- xii. Gutters for all roofs for stormwater management
- xiii. A local incinerator for collecting and burning sanitary towels.
- xiv. All pipe work and cables should be concealed
- xv. Tiled walls (up to 1.5m above floor level in toilets and 2.0m in bathing rooms) and painted walls

- xvi. Sanitary disposal units for each female unit: clean, with a no touch lid, lined with removable polythene bag
- xvii. Rubbish bin: clean, with a “no touch” lid, lined with polythene for safe removal of garbage
- xviii. Use of low-cost energy/electric power fixes
- xix. Cubicle doors lockable from the inside.
- xx. Cistern or pour flushing system
- xxi. Pupil to Stance ratio of 1:40

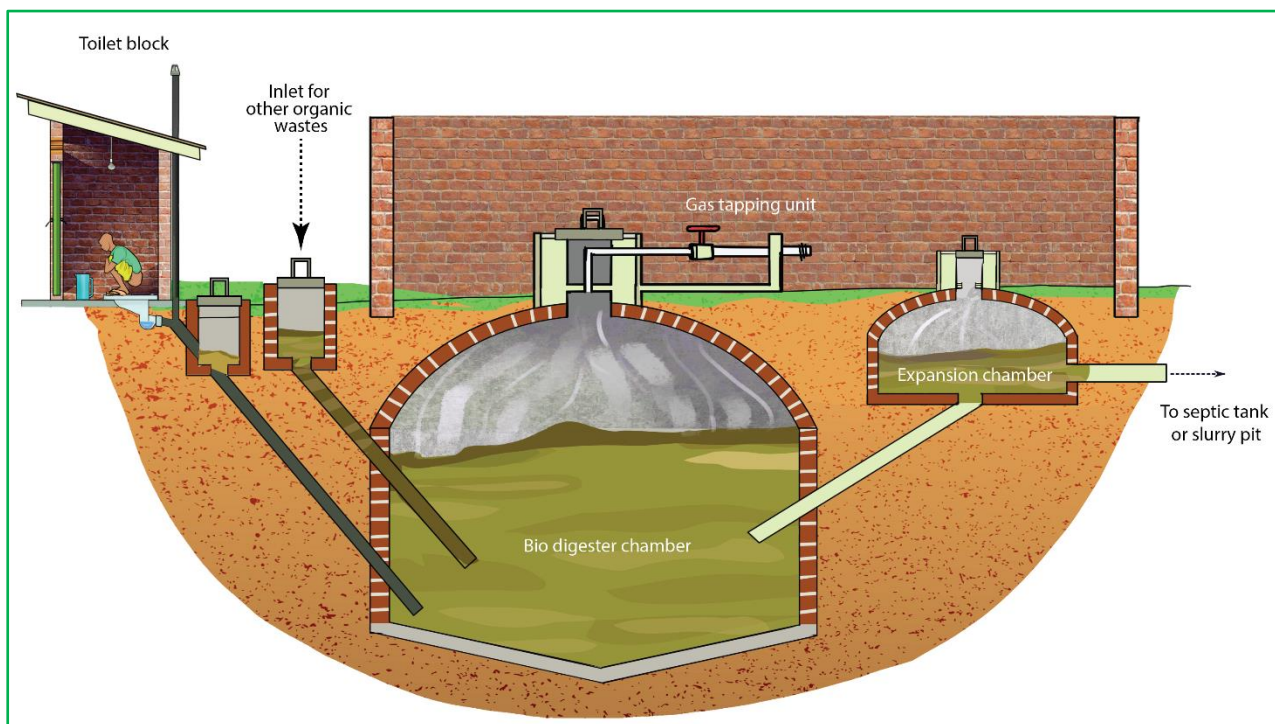

**Figure 3-2:** School flushing toilets

### 3.3.2 Bio-Latrine for institutions

#### Key Minimum Standards

- i. Minimum land area requirement: 20m x 15m
- ii. Located preferably on firm and sloping ground to allow slurry flow by gravity.
- iii. Stance to user ratio: 1:40
- iv. Bio-digester chamber built 0.3m below the floor of the toilets and well-lined to prevent gas leakage.



**Figure 3-3:** Bio-toilet for Institutions

### 3.3.3 Public Water Closets/Flushing toilets

#### Key Minimum Standards

- i. Toilet stances:
  - 2 stances for females and 2 stances for males
  - Floor dimensions: 1.0m by 1.5m and 1.5m by 1.5m for PWD stances
- ii. 1 shower facility for females and males each
- iii. Double hooks (for hanging) fixed behind cubical doors
- iv. Ablution tap coupled with hose and a spring-loaded nozzle in at least 1 stance each for male and female.
- v. Floor trap in stances with the abluion tap and flooring should drain towards floor trap so as to keep the floor as dry as possible.
- vi. Design rule of thumb: one stance for 100 users per day for public places such as markets and parking areas.
- vii. Standby attendant and cleaning at 3-hour intervals if more than 200 users per stance.
- viii. Urinals for males:
  - If 2 or more urinals are installed, one should be installed at child's height
  - Number of urinals required (Table 3-1)

**Table 3-1:** Public toilet urinal ratios

No. of users	Urinal trough length	Urinal bowls
100	1.0m	One single
200	1.9m	Two singles or equivalent
300	2.85m	Three singles or equivalent

- ix. A hand washing facility with soap for each side (male and female)
- x. A fence with a lockable gate
- xi. Windows clear enough to provide day light
- xii. Raised water storage tank with a capacity of at least 2500 litres
- xiii. Provide ramps with:
  - At least 1.3m width with a slope not exceeding 1:10 for spans of maximum 1.0m and 1:20 for longer spans. For slanting grounds at entrance, maximum slope of 1:25 is acceptable
  - Hand rails of min 0.6m height ending 0.3m from both ends of the ramp
  - Hard and non-slip surface
  - landing of minimum 1.3m wide by 1.3m long at every 10m, change of direction and bottom of ramp
- xiv. Access road of minimum 4.0m width to facilitate septic tank emptying with a vacuum truck in non-sewered areas
- xv. Signage with visible and legible directions to toilet location
- xvi. Should face public areas such as footpaths, roads, or places of high human traffic
- xvii. Space for an operator to sit
- xviii. All pipe work and cables should be concealed
- xix. Tiled walls (up to 1.5m above floor level in toilets and 2.0m in bathing rooms) and painted walls
- xx. Sanitary disposal units for each female unit: clean, with a no touch lid, lined with removable polythene bag
- xxi. Rubbish bin: clean, with a “no touch” lid, lined with polythene for safe removal of garbage
- xxii. Use of low-cost energy/electric power fixes
- xxiii. Cubicle doors lockable from the inside.

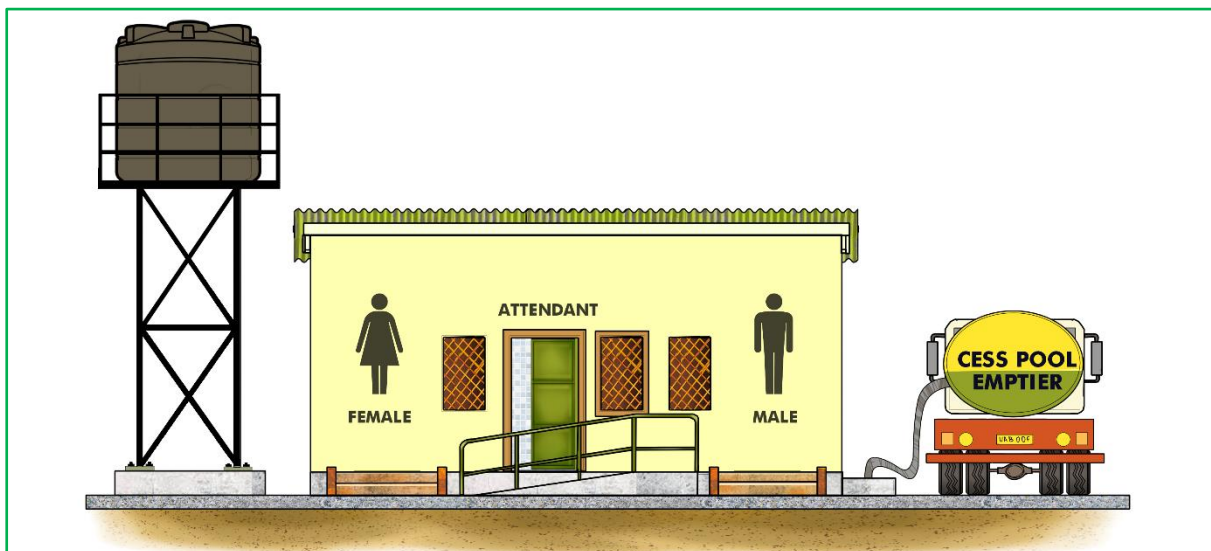

**Figure 3-4:** Public Toilets



### 3.3.4 Portable/Mobile Toilets (Mobilets)

#### Key Minimum Standards

- i. One facility for 20 people
- ii. 20 people or more, but less than 200: provide 1 toilet and 1 urinal per 40 users.
- iii. 200 people or more: provide 1 toilet and 1 urinal per 50 people.

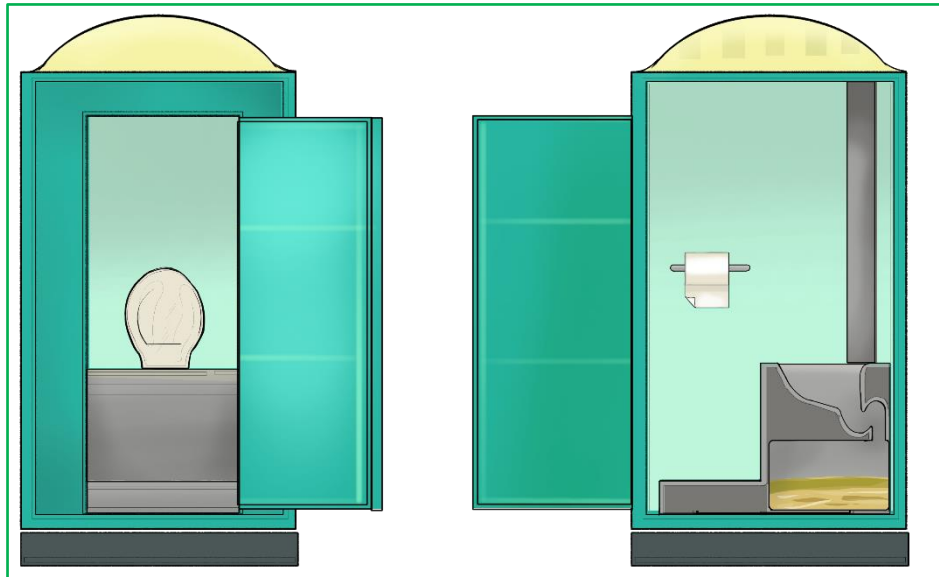

Figure 3-5: Portable toilet

## 4 ADD-ONS AND KEY TOILET ACCESSORIES

This section provides details and standards on: (i) UDDT user interface options, (ii) Urinals, (iii) containment and disposal facilities, (iii) hand washing facilities, and (iv) incinerators used for menstrual hygiene management.

### 4.1 UDDT User Interfaces

The interface used to separate the urine from faeces for wipers and that which separates anal cleansing water, urine and faeces for washers are presented (Figure 4-1)

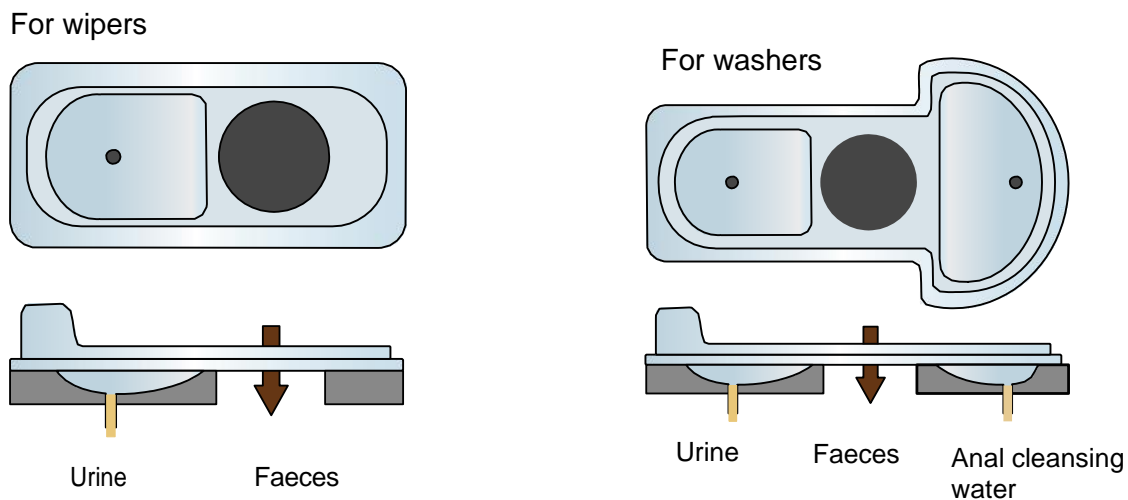
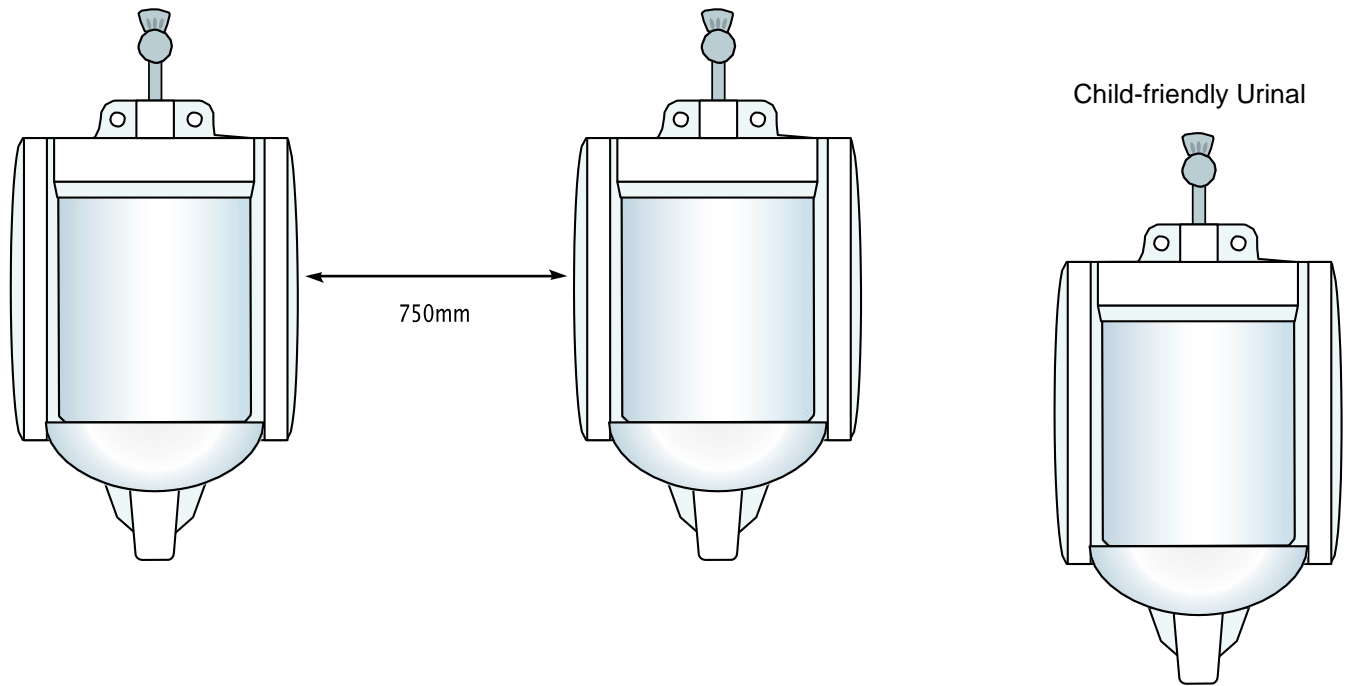

**Figure 4-1:** Urine Diversion Dry Toilet user interfaces

### 4.2 Urinals

#### Key Minimum Standards

- i. May be individual wall-mounted units, more than 300mm wide, or as a trough properly graded towards the opposite wall.
- ii. If more than one wall-mounted unit provided, one should be child friendly.
- iii. Urinal troughs should be bordered by walls on the left and on the right side.
- iv. Lip of the collection area should project from the wall by at least 250mm.
- v. A concrete step/landing of at least 325mm could be built in front of the urinal. Between the step and the wall behind should be at least 575mm.
- vi. Distance between urinals 750mm.
- vii. Discharge pipes or urinal channels should be laid at a slope of not less than 1 in 40.



**Figure 4-2:** Wall mounted urinals

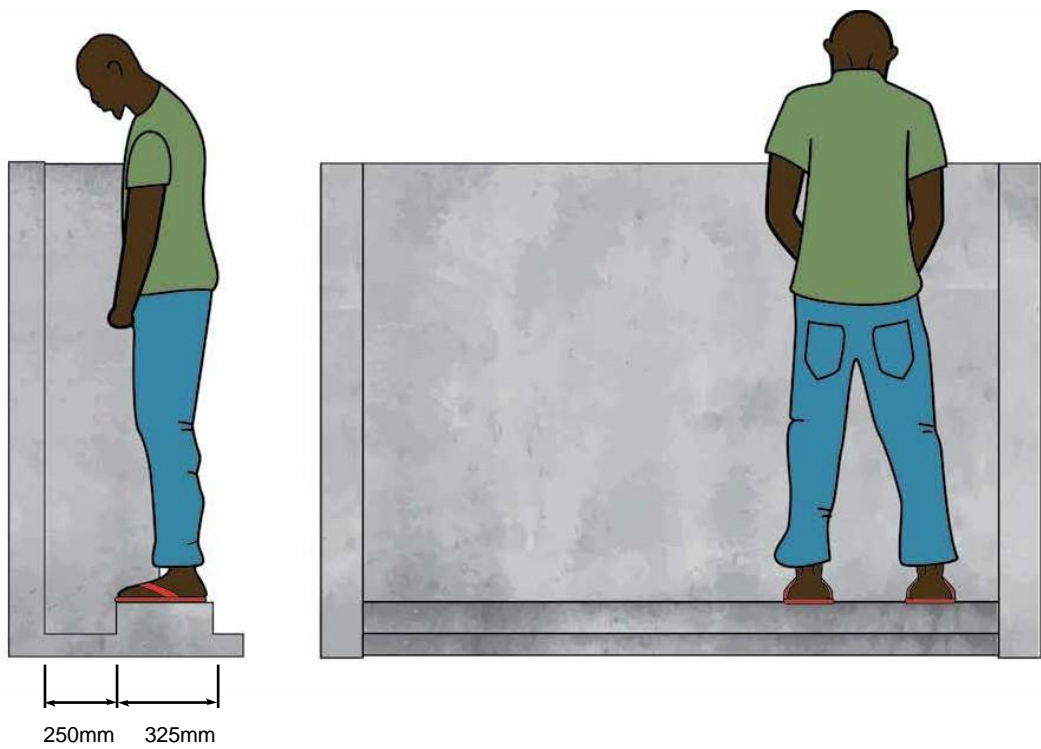

**Figure 4-3:** Trough urinal

## 4.3 Containment/disposal

### 4.3.1 Septic Tank

Septic tanks are watertight chambers sited below ground level for storage and partial treatment of excreta and grey water. They are made from reinforced concrete and brick work or plastic materials (prefabricated form or modular tank units). During operation of the septic tank, most of the solids settle in the first chamber, while oil and grease or scum float on top. A baffle prevents the scum from being carried over in the effluent which is then discharged to a soak away pit. Available plastic options are HDPE pre-fabricated units that come as a complete unit ready for installation. These options are also well suited for areas with a high-water table

#### **Key Minimum Standards – for the brick-based option**

- i. Should comprise 2 underground water tight compartments/chambers
- ii. The first chamber is at least twice the size of the second chamber
- iii. Should not be constructed under any buildings nor within 3m of any building or plot boundary; nor within 30.5m of any ground water source.
- iv. Minimum and maximum water depth levels of 1.4m and 2m, respectively.
- v. A T-shaped outlet pipe to further reduce the amount of scum and solids that are discharged to soak away.
- vi. The base should be at least 15cm thick concrete.
- vii. Ventilation pipe of at least 50mm diameter fitted with mesh/fly screen
- viii. Each compartment of a septic tank shall have an access not less than 455mm by 610mm (rectangular) or opening 500mm diameter (circular).
- ix. Septic tank emptied at least 5 years or when sludge fills ones-third of the tank volume, whichever occurs first.
- x. A filter media such as gravel, crushed rock, activated carbon or specifically manufactured plastic pieces can be included in the second chamber for improved performance.
- xi. Manholes leading to septic tank are placed at the following locations:
  - Points of change in direction
  - At junctions
  - Where there is a change in gradient/grade
  - At intervals of ≤50m for very long straight sewer pipes.

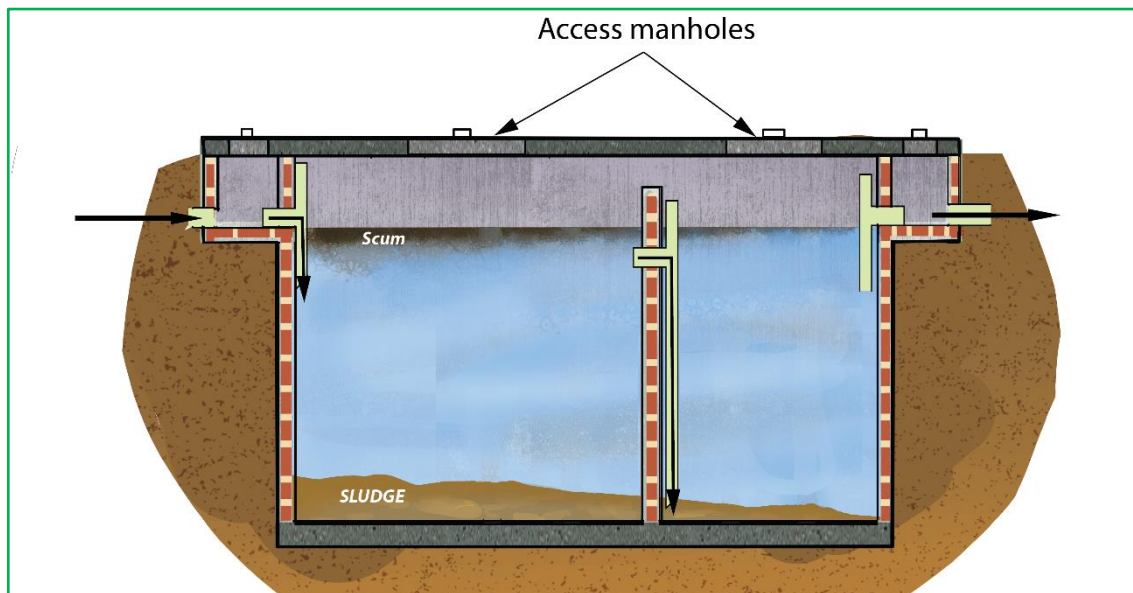

**Figure 4-4:** Septic Tank Containment

### 4.3.2 Anaerobic Baffled Reactor

An anaerobic baffled reactor (ABR) is an improved Septic Tank with a series of baffles under which the wastewater is forced to flow. The increased contact time with the active biomass (sludge) results in improved treatment. It is applicable in bigger catchment areas such as schools and public places.

#### Key Minimum Standards

- i. Comprises 4 to 6 compartments/chambers
- ii. The compartment width to length ratio is 3 to 4.
- iii. The reactor depth ranges between 1 to 3m depending on excavation costs.
- iv. The connections between chambers can be designed with vertical pipes or baffles.
- v. Accessibility to all chambers is provided for maintenance.
- vi. The tank is vented to allow for controlled release of odourless gases.
- vii. ABR location same as for septic tank.
- viii. Manhole locations same as septic tank.

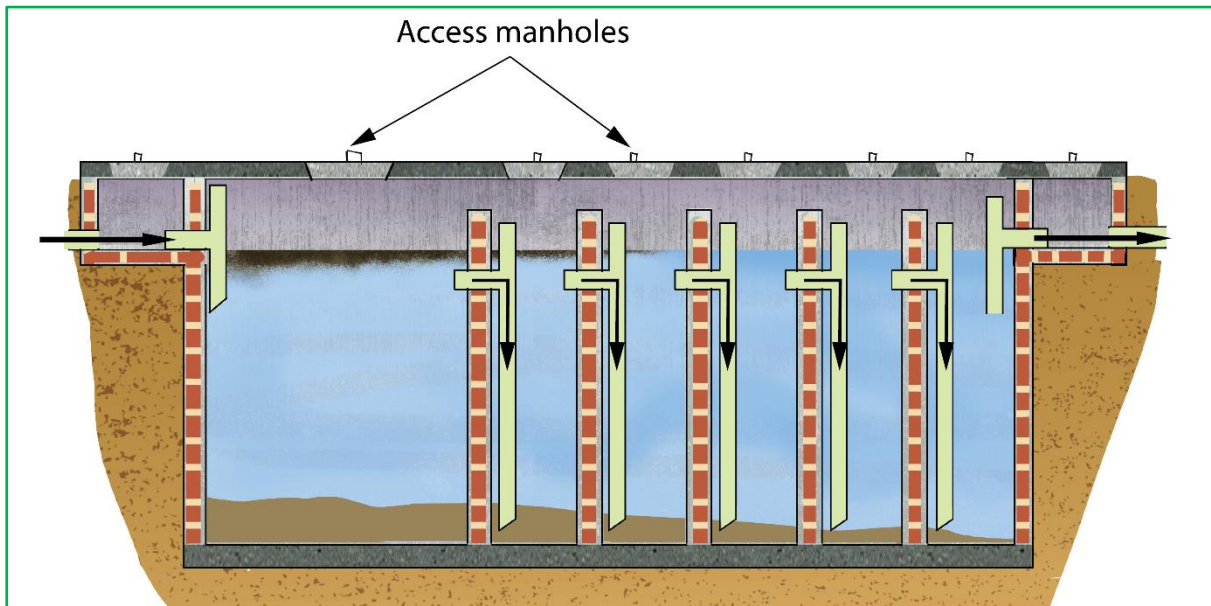

**Figure 4-5:** Anaerobic Baffled Reactor (ABR)

### 4.3.3 Grease trap and Grease Interceptor Tank

These are used to preliminary trap oil & grease so as it can easily be collected and removed. Built before septic tank, ABR and soak pit to retard the accumulation of solids and minimize subsequent blockages of the sanitation technologies. Grease traps are installed at single household while the Grease interceptor tank is installed on institutional kitchens, restaurants or industrial sites.

#### Key Minimum Standards

- i. They can be made of brickwork, concrete or plastic, with an odour-tight cover.
- ii. Use baffles or T-pipes at the inlet and outlet prevents turbulence at the water surface and separate floating materials from the effluent.
- iii. Grease trap needs to be cleaned frequently (once a week to once a month).
- iv. Grease interceptor tank cleaned every 6 to 12 months.
- v. A grease trap can be located directly under the sink or outdoors while grease interceptor tank only located outdoors

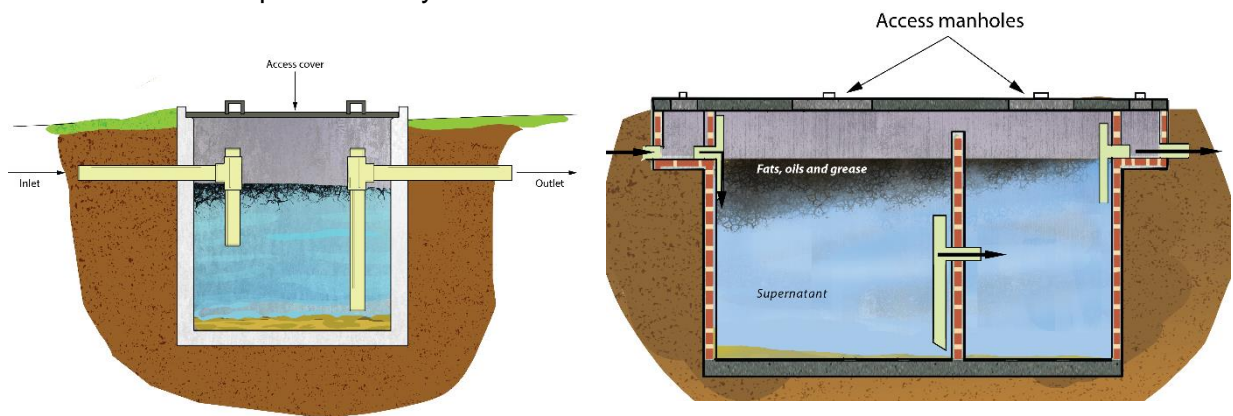

**Figure 4-6:** Grease trap (left) and grease interceptor tank (right)

#### 4.3.4 Soak pit

A soakaway is a porous-walled chamber or unlined chamber filled with gravel that allows the septic tank/ABR effluent to slowly soak into the ground. It is covered with an impervious layer of polythene sheet or metallic sheet. Gravel packed soak pits are the common practice in Uganda. To prevent clogging, it should be used for discharging pre-settled blackwater or greywater.

##### Key Minimum Standards

- i. Depth should be between 1.5 and 4m. The base should never be less than 2m above the groundwater table.
- ii. Minimum location distance:
  - 1.5m from buildings, pathways/walkways
  - 3.0m from water pipes and large trees
  - 30m from cuts/embankments/ water source (streams and rivers).
- iii. Should be kept away from high-traffic areas not to compact the soil above or around it.
- iv. It can be left empty or lined with a porous material to provide support and prevent collapse.
- v. It can be left unlined and filled with coarse rocks and gravel.
- vi. A layer of sand and fine gravel should be spread across the bottom to help disperse the flow.
- vii. A removable (preferably concrete) cover can be used to seal the pit and allow for future access.
- viii. They are not appropriate for areas prone to flooding or that have high groundwater tables.

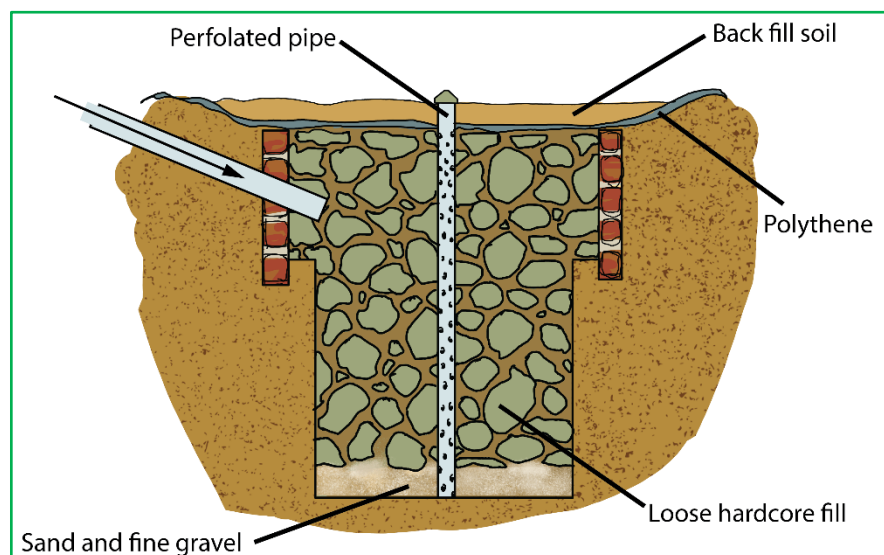

**Figure 4-7:** Gravel filled soak pit

### 4.3.5 Drainage field

It is a network of perforated pipes that are laid in underground gravel-filled trenches to dissipate the effluent from a septic tank or Anaerobic baffled reactor (ABR). They require a large area and unsaturated soil with good absorptive capacity to effectively dissipate the effluent, hence are not appropriate for dense urban areas.

#### Key Minimum Standards

- i. Each trench is 0.3 to 1.5 m deep and 0.3 to 1 m wide.
- ii. The bottom of each trench is filled with about 15 cm of clean rock and a perforated distribution pipe is laid on top.
- iii. The pipe should be placed at least 15 cm beneath the surface to prevent effluent from surfacing.
- iv. The trenches should be dug no longer than 20 m in length and at least 1 to 2 m apart.
- v. To prevent contamination, a leach field should be located at least 30 m away from any drinking water source.
- vi. A leach field should be laid out such that it will not interfere with a future sewer connection

### 4.4 Handwashing facilities

#### Key Minimum Standards

- i. For wash basins:
  - Minimum size of 500mm in length and 400mm in width.
  - Where there are 2 or more basins in public places, one should be installed at child's height
- ii. Should be installed outside the toilets for common use by all users, especially for public toilets
- iii. The wash basin in toilets for PWD should be within reach from a seated position so that one can use it without standing up. Recommended heights: high sink of 0.8m or low sink of 0.4m for crawling PWD children
- iv. Convenient handwashing facilities at less than 5m from toilets
- v. For schools:
  - Group handwashing facilities such as WASHaLOT 3.0 can be used.
  - handwashing points to student ratio is 1:40
  - located in most convenient places such as toilets, kitchen and classrooms
- vi. Allow proper drainage of wastewater



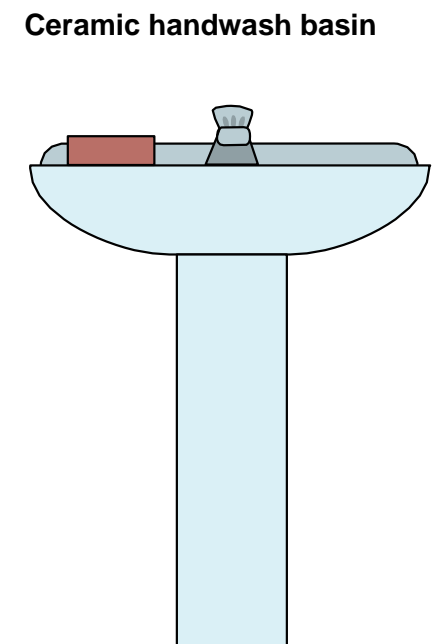
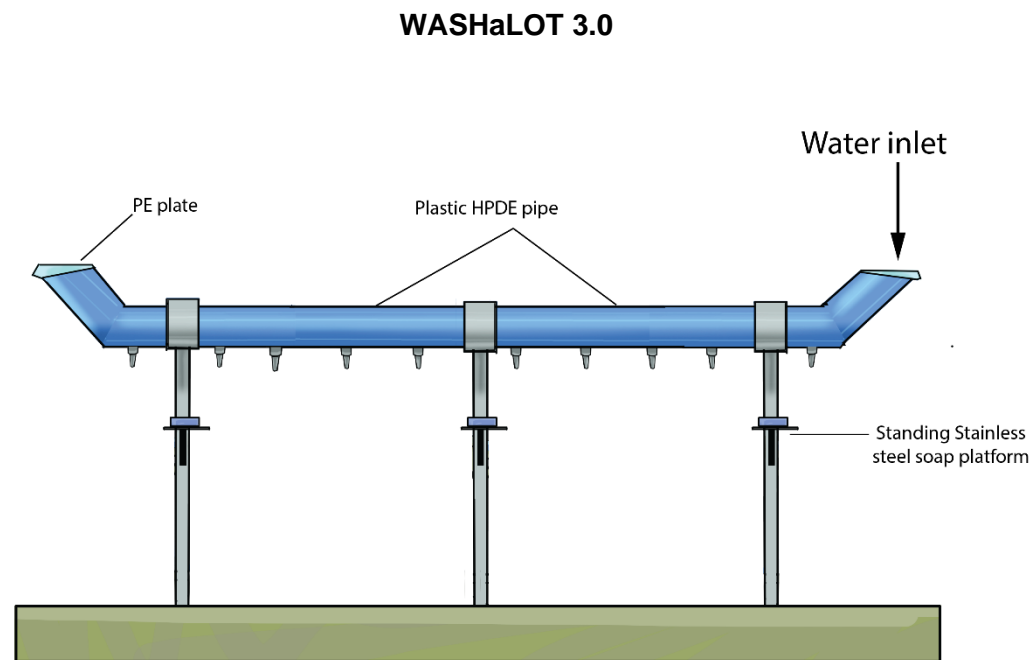
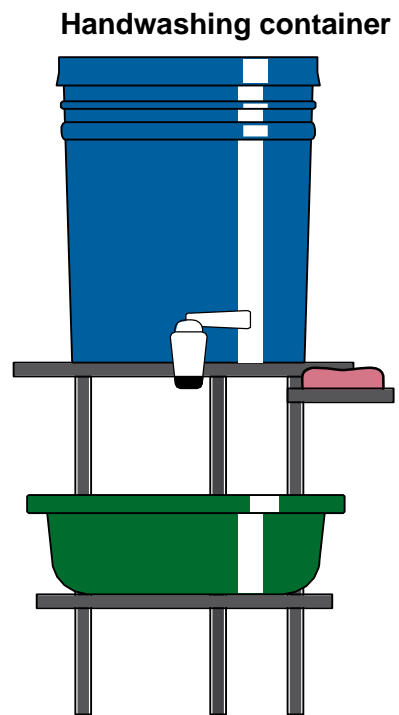

**Figure 4-8:** Different handwashing facilities

## 4.5 Incinerator

An incinerator is used to safely and hygienically dispose of menstrual wastes from schools and medical wastes from health centres. Waste volume and mass reduce by over 90%. Incinerators can be built from bricks or metallic sheets.

### Key Minimum Standards

- i. Every school is required to have at least an incinerator for collecting and burning of sanitary pads.
- ii. Minimum height of chimney is 1.5 m
- iii. Operational temperature of at least 600°C to avoid emitting excess hazardous gases.
- iv. Site location:
  - A flat, open terrain is desirable. Not areas with tall trees and vegetation to prevent smoke disappearance.
  - Not near populated areas, such as residential, markets, etc.
  - Not near agricultural areas, such as leafy vegetables and animal feeds
  - At least 30 m from nearest building and storage areas holding flammable materials
  - Areas of low security risks.
  - Away from the prevailing wind direction (always at the back of the facility)

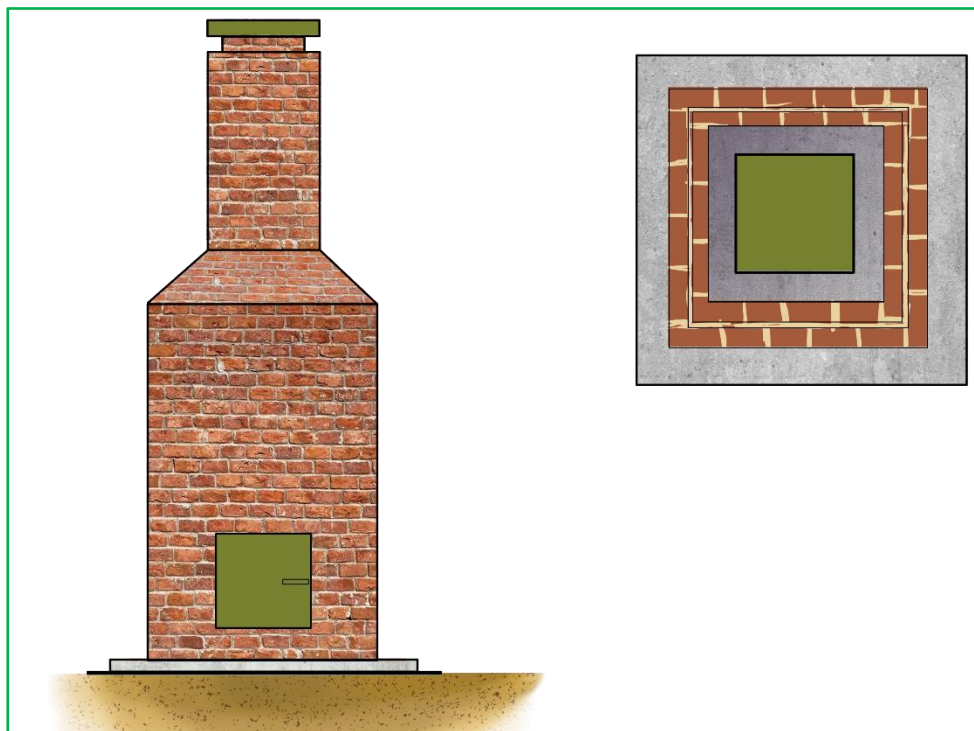

**Figure 4-9:** Incinerator facility

## BIBLIOGRAPHY

- Bureau Of Indian Standards (1985): Indian Standard Code Of Practice For Installation Of Septic Tanks Part I Design Criteria And Construction (Second Revision) Is : 2470 ( Part 1 ) Reaffirmed 1996.
- Cotton A, Franceys R, Pickford J, Saywell D. On-Plot Sanitation in low-income urban communities. WEDC Loughborough Univ. of Technology, Loughborough: 1995.
- Eawag-Sandec/WSSCC/UN-HABITAT (2011): Community-Led Urban Environmental Sanitation Planning: CLUES Complete Guidelines for Decision-Makers with 30 Tools
- Franceys R, Pickford J, Reed R. A guide to the development of on-site sanitation. London, UK: 1992. doi:10.1002/ppul.1950120122.
- GoU (1997): The national sanitation policy for Uganda.
- KCCA, (2014): Improving Faecal Sludge (FS) Management for On-Site Sanitation in Kampala City, Uganda.
- Mara DD (1984). The design of ventilated improved pit latrines. International Bank for Reconstruction and Development/The World Bank.
- Mara, DD. (1996): Low-Cost Urban Sanitation. Wiley, Chichester, UK.
- McGhee JT. Water Supply and Sewerage. 6th Edition. New Delhi: McGraw Hill; 1991.
- Metcalf and Eddy (2003). Wastewater Engineering: Treatment and Reuse. 4th ed. New York: McGraw Hill.
- Ministry of Education and Sports. Water, Sanitation and Hygiene in Schools Standards - Uganda. Kampala, Uganda: 2016.
- Ministry of Lands, Housing and Urban development, Uganda (2011): National physical planning guidelines and standards.
- Ministry-of-Health (2017). National guidelines for prevention and control of healthcare facilities.
- Monvois, J., Gabert, J., Frenoux, C., Guillaume, M., (2010): How To Select Appropriate Technical Solutions for Sanitation. Concerted Municipal Strategies (CMS) and Solidarité Eau (pS-Eau).
- Polprasert, C. and Rajput, VS. (1982): Environmental Sanitation Reviews: Septic Tank and Septic Systems. Environmental Sanitation Information Center, Bangkok, AIT, Thailand. pp 68–74. (Comprehensive design manual).
- Restroom Association (Singapore) & the National Environment Agency: A Guide to Better Public Toilet Design and Maintenance.
- Schönning, C., Stenström T.A., (2004). Guidelines for safe use of urine and faeces in Ecological Sanitation Systems. EcoSanRes Publication series, ISBN 91 88714 93 4.
- Strande, L., Ronteltap, M., Brdjanovic, D., (2014): Faecal sludge management – systems approach for implementation and operation. London, IWA.
- Tilley, E., Ulrich, L., Luethi, C., Reymond, P., Zurbrügg, C. (2014): Compendium of Sanitation Systems and Technologies. 2<sup>nd</sup> Revised Edition. Duebendorf, Switzerland:
- Uganda National Action on Physical Disability and Ministry of Gender, Labour and Social Development, (2010): ACCESSIBILITY STANDARDS A practical guide to create a barrier-free physical environment in Uganda.
- United Nations Children’s Fund - UNICEF (1998): Towards Better Programming A Manual on School Sanitation and Hygiene.
- Water For People (2015): Innovative Capture Technologies Kampala Sanihub Project: Facilitating The Emergence Of Sanitation Technologies In Developing Economies.
- WHO/UNICEF. Core questions and indicators for monitoring WASH in Schools in the Sustainable Development Goals. Geneva, Switzerland: 2016.
- WHO/UNICEF. Water , Sanitation and Hygiene (WASH) in Schools: A companion to the Child Friendly Schools Manual. New York, USA: 2012.
- World Health Organization (2009): Water, sanitation and hygiene standards for schools in low-cost settings Edited by John Adams, Jamie Bartram, Yves Chartier, Jackie Sims.
- WTF (Water Trust Fund Kenya), (2009a): Public sanitation design guideline in Kenya.

## APPENDIX A1: SAMPLE DETAILED ENGINEERING DRAWINGS

## APPENDIX A2: INDICATIVE TECHNOLOGY COSTS