

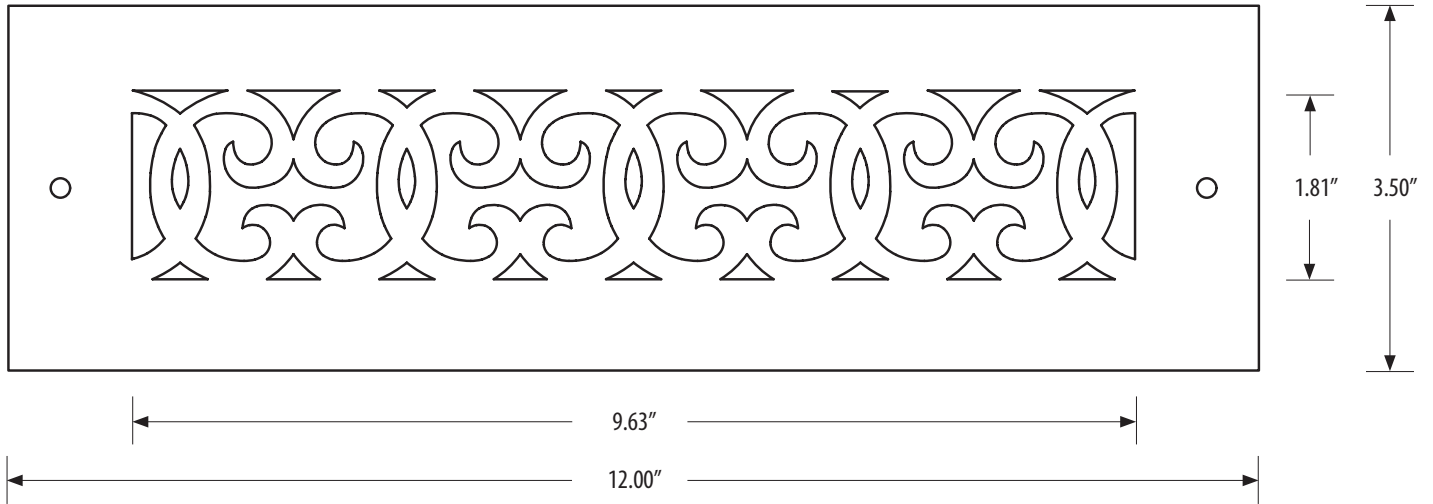

V-412 / Versailles Grille

Spec Sheet



MODEL: V-412

- Duct Size Dimensions: 10.00" x 2.25"
- Outside Dimensions: 12.00" x 3.50"
- Design Dimensions: 9.63" x 1.81"
- Made in USA

OPTIONS:

- **Material:** Aluminum Steel
- **Thickness:** 1/8" 3/16"
- **Finish:** Black Champagne Bronze Grey
 Oil-Rubbed Bronze Satin Nickel Silver
 Sun Gold White
- With Holes (as shown)
 No Holes (cross out holes on drawing)
- Underside Lip No Underside Lip
- With Louver Without Louver

NOTES:

- Pattern scale subject to change with size of grille
- Wall and Ceiling Installation: requires Holes/screws
- Floor Installation:
 - Requires Underside Lip when you choose No Holes
 - Thickness 1/8" not recommended
- Aluminum available in 3/16" only

JOB NAME: _____	SUBMITTED BY: _____
LOCATION: _____	
ARCHITECT: _____	
ENGINEER: _____	
CONTRACTOR: _____	



V-414 / Versailles Grille

Spec Sheet

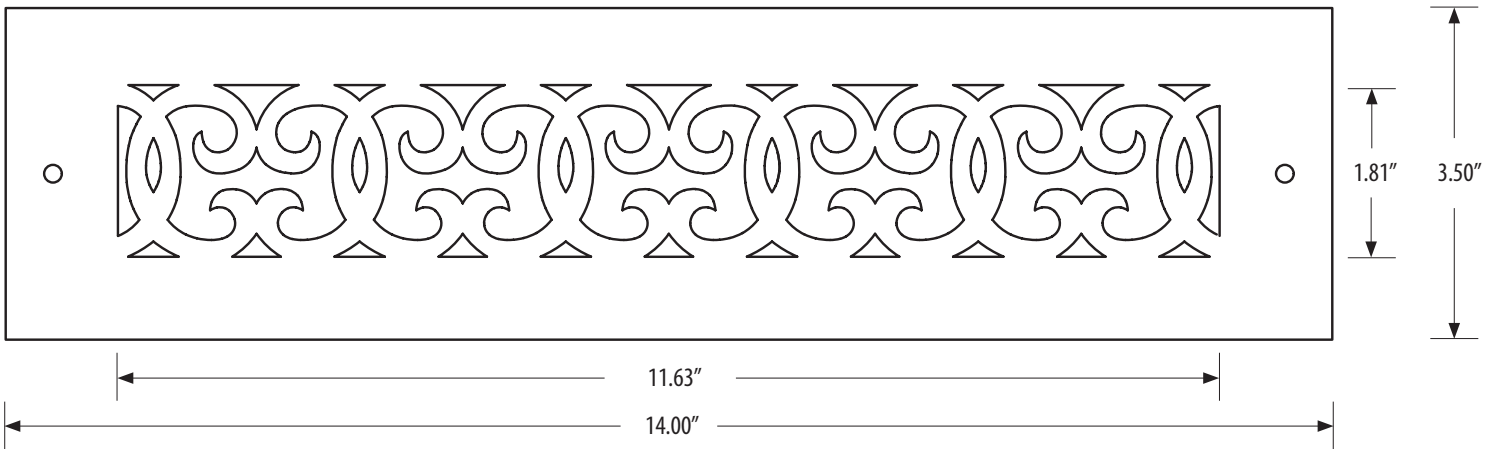

MODEL: V-414

- Duct Size Dimensions: 12.00" x 2.25"
- Outside Dimensions: 14.00" x 3.50"
- Design Dimensions: 11.63" x 1.81"
- Made in USA

OPTIONS:

- **Material:** Aluminum Steel
- **Thickness:** 1/8" 3/16"
- **Finish:** Black Champagne Bronze Grey
 Oil-Rubbed Bronze Satin Nickel Silver
 Sun Gold White
- With Holes (as shown)
 No Holes (cross out holes on drawing)
- Underside Lip No Underside Lip
- With Louver Without Louver

NOTES:

- Pattern scale subject to change with size of grille
- Wall and Ceiling Installation: requires Holes/screws
- Floor Installation:
 - Requires Underside Lip when you choose No Holes
 - Thickness 1/8" not recommended
- Aluminum available in 3/16" only

JOB NAME: _____	SUBMITTED BY: _____
LOCATION: _____	
ARCHITECT: _____	
ENGINEER: _____	
CONTRACTOR: _____	



V-416 / Versailles Grille

Spec Sheet

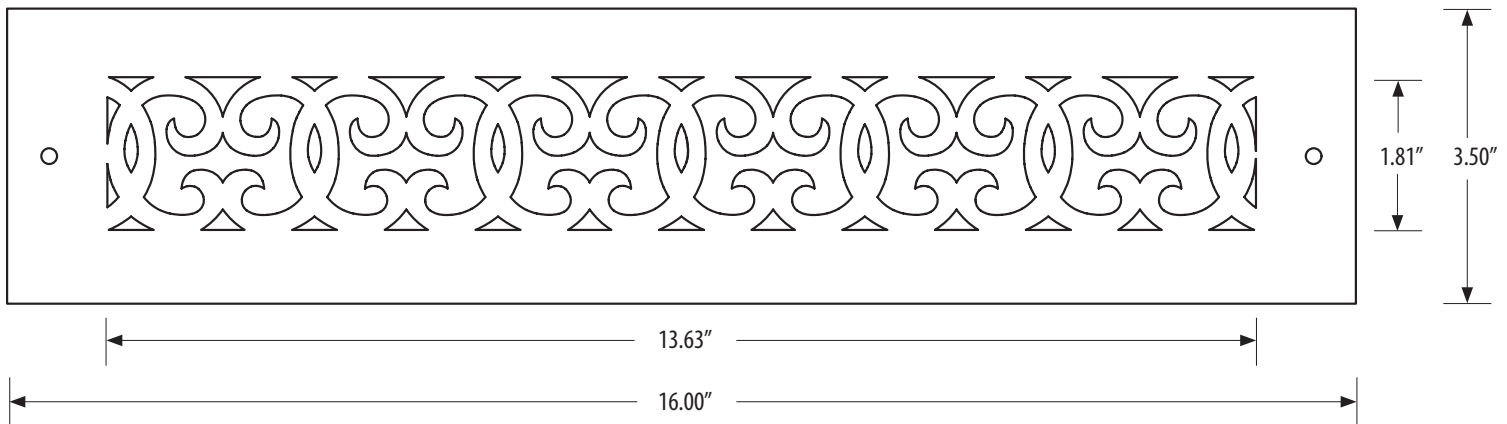

MODEL: V-416

- Duct Size Dimensions: 14.00" x 2.25"
- Outside Dimensions: 16.00" x 3.50"
- Design Dimensions: 13.63" x 1.81"
- Made in USA

OPTIONS:

- **Material:** Aluminum Steel
- **Thickness:** 1/8" 3/16"
- **Finish:** Black Champagne Bronze Grey
 Oil-Rubbed Bronze Satin Nickel Silver
 Sun Gold White
- With Holes (as shown)
 No Holes (cross out holes on drawing)
- Underside Lip No Underside Lip
- With Louver Without Louver

NOTES:

- Pattern scale subject to change with size of grille
- Wall and Ceiling Installation: requires Holes/screws
- Floor Installation:
 - Requires Underside Lip when you choose No Holes
 - Thickness 1/8" not recommended
- Aluminum available in 3/16" only

JOB NAME: _____	SUBMITTED BY: _____
LOCATION: _____	
ARCHITECT: _____	
ENGINEER: _____	
CONTRACTOR: _____	



V-610 / Versailles Grille

Spec Sheet

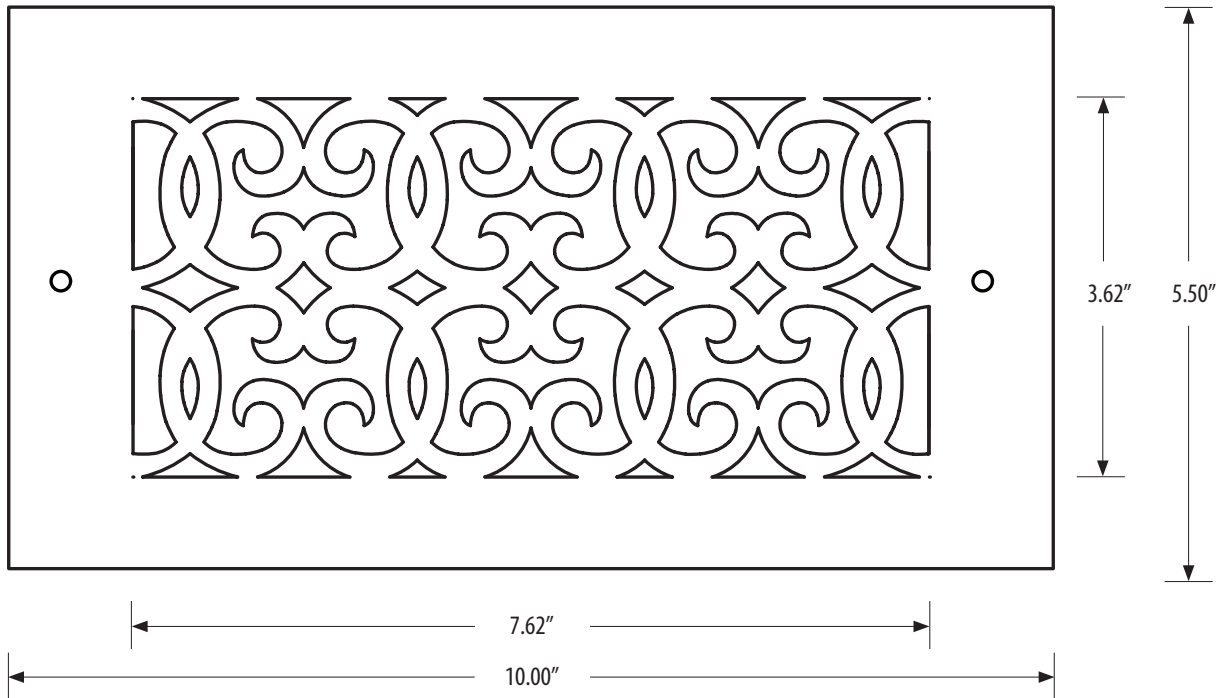

MODEL: V-610

- Duct Size Dimensions: 8.00" x 4.00"
- Outside Dimensions: 10.00" x 5.50"
- Design Dimensions: 7.62" x 3.62"
- Made in USA

OPTIONS:

- **Material:** Aluminum Steel
- **Thickness:** 1/8" 3/16"
- **Finish:** Black Champagne Bronze Grey
 Oil-Rubbed Bronze Satin Nickel Silver
 Sun Gold White
- With Holes (as shown)
 No Holes (cross out holes on drawing)
- Underside Lip No Underside Lip
- With Louver Without Louver

NOTES:

- Pattern scale subject to change with size of grille
- Wall and Ceiling Installation: requires Holes/screws
- Floor Installation:
 - Requires Underside Lip when you choose No Holes
 - Thickness 1/8" not recommended
- Aluminum available in 3/16" only

JOB NAME: _____	SUBMITTED BY: _____
LOCATION: _____	
ARCHITECT: _____	
ENGINEER: _____	
CONTRACTOR: _____	



V-612 / Versailles Grille

Spec Sheet

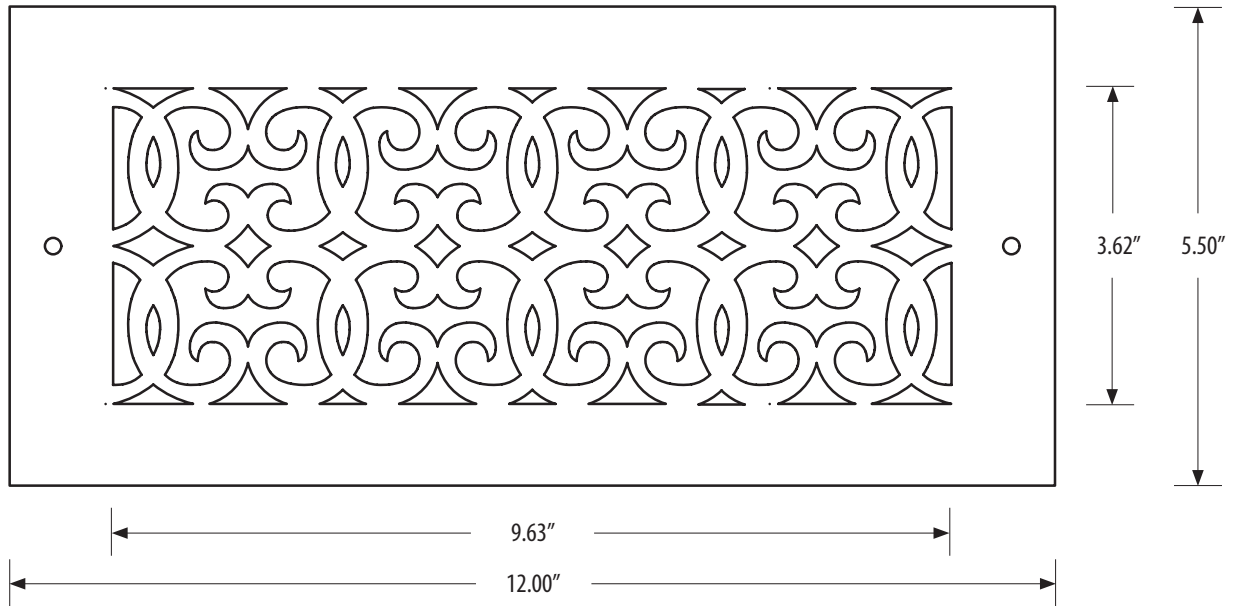

MODEL: V-612

- Duct Size Dimensions: 10.00" x 4.00"
- Outside Dimensions: 12.00" x 5.50"
- Design Dimensions: 9.63" x 3.62"
- Made in USA

OPTIONS:

- **Material:** Aluminum Steel
- **Thickness:** 1/8" 3/16"
- **Finish:** Black Champagne Bronze Grey
 Oil-Rubbed Bronze Satin Nickel Silver
 Sun Gold White
- With Holes (as shown)
 No Holes (cross out holes on drawing)
- Underside Lip No Underside Lip
- With Louver Without Louver

NOTES:

- Pattern scale subject to change with size of grille
- Wall and Ceiling Installation: requires Holes/screws
- Floor Installation:
 - Requires Underside Lip when you choose No Holes
 - Thickness 1/8" not recommended
- Aluminum available in 3/16" only

JOB NAME: _____	SUBMITTED BY: _____
LOCATION: _____	
ARCHITECT: _____	
ENGINEER: _____	
CONTRACTOR: _____	



V-614 / Versailles Grille

Spec Sheet

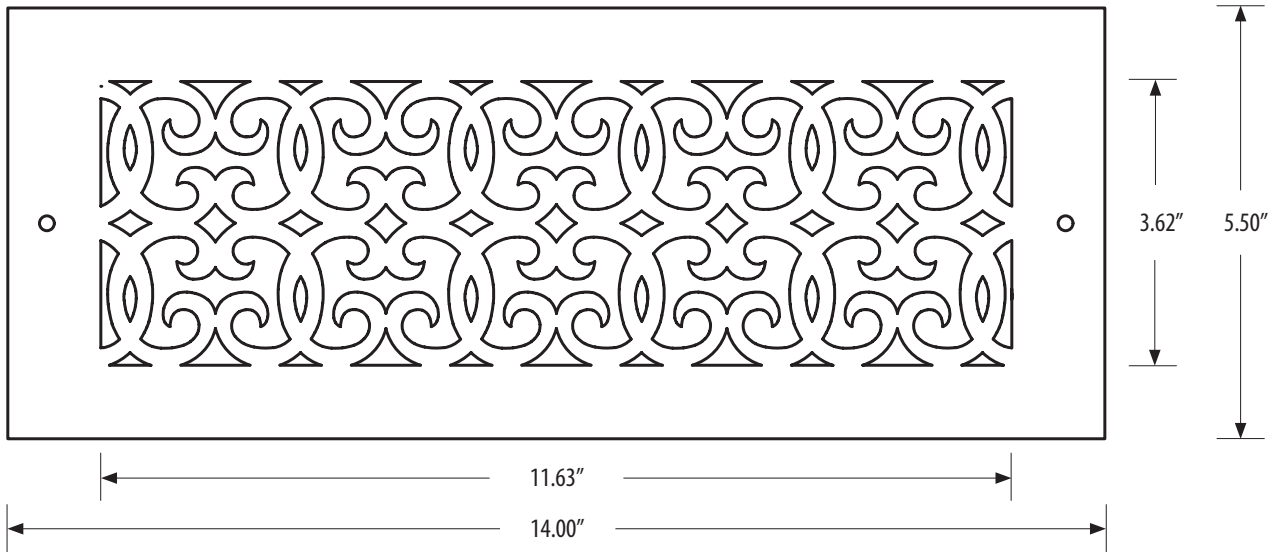

MODEL: V-614

- Duct Size Dimensions: 12.00" x 4.00"
- Outside Dimensions: 14.00" x 5.50"
- Design Dimensions: 11.63" x 3.62"
- Made in USA

OPTIONS:

- **Material:** Aluminum Steel
- **Thickness:** 1/8" 3/16"
- **Finish:** Black Champagne Bronze Grey
 Oil-Rubbed Bronze Satin Nickel Silver
 Sun Gold White
- With Holes (as shown)
 No Holes (cross out holes on drawing)
- Underside Lip No Underside Lip
- With Louver Without Louver

NOTES:

- Pattern scale subject to change with size of grille
- Wall and Ceiling Installation: requires Holes/screws
- Floor Installation:
 - Requires Underside Lip when you choose No Holes
 - Thickness 1/8" not recommended
- Aluminum available in 3/16" only

JOB NAME: _____	SUBMITTED BY: _____
LOCATION: _____	
ARCHITECT: _____	
ENGINEER: _____	
CONTRACTOR: _____	



V-616 / Versailles Grille

Spec Sheet

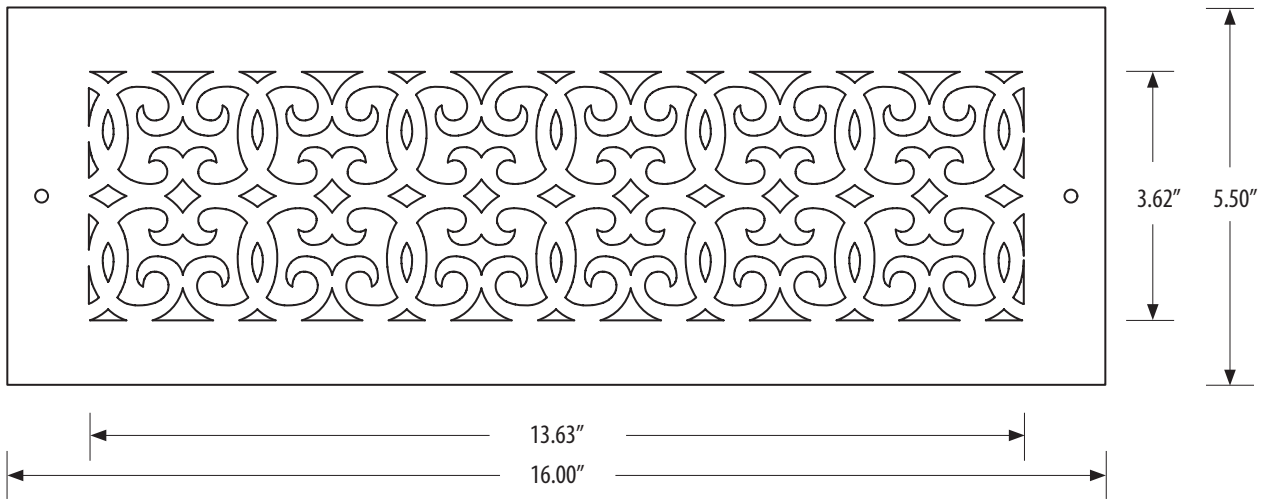

MODEL: V-616

- Duct Size Dimensions: 14.00" x 4.00"
- Outside Dimensions: 16.00" x 5.50"
- Design Dimensions: 13.63" x 3.62"
- Made in USA

OPTIONS:

- **Material:** Aluminum Steel
- **Thickness:** 1/8" 3/16"
- **Finish:** Black Champagne Bronze Grey
 Oil-Rubbed Bronze Satin Nickel Silver
 Sun Gold White
- With Holes (as shown)
 No Holes (cross out holes on drawing)
- Underside Lip No Underside Lip
- With Louver Without Louver

NOTES:

- Pattern scale subject to change with size of grille
- Wall and Ceiling Installation: requires Holes/screws
- Floor Installation:
 - Requires Underside Lip when you choose No Holes
 - Thickness 1/8" not recommended
- Aluminum available in 3/16" only

JOB NAME: _____	SUBMITTED BY: _____
LOCATION: _____	
ARCHITECT: _____	
ENGINEER: _____	
CONTRACTOR: _____	



V-808 / Versailles Grille

Spec Sheet

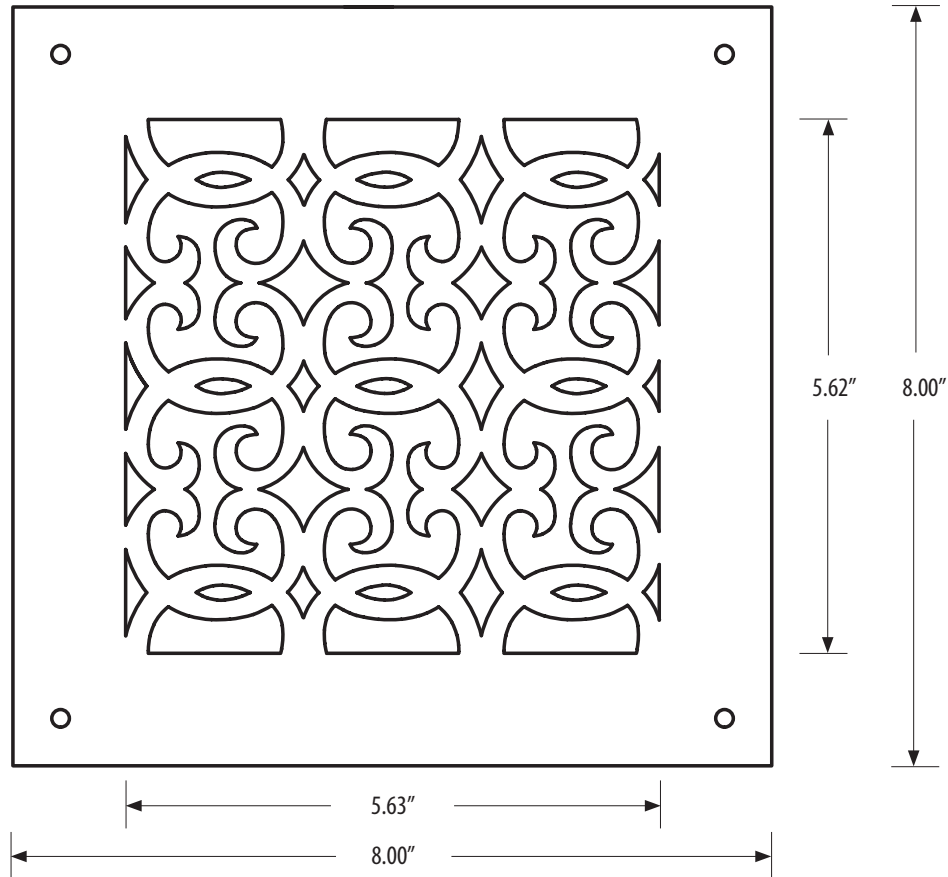

MODEL: V-808

- Duct Size Dimensions: 6.00" x 6.00"
- Outside Dimensions: 8.00" x 8.00"
- Design Dimensions: 5.63" x 5.62"
- Made in USA

OPTIONS:

- **Material:** Aluminum Steel
- **Thickness:** 1/8" 3/16"
- **Finish:** Black Champagne Bronze Grey
 Oil-Rubbed Bronze Satin Nickel Silver
 Sun Gold White
- With Holes (as shown)
 No Holes (cross out holes on drawing)
- Underside Lip No Underside Lip
- With Louver Without Louver

NOTES:

- Pattern scale subject to change with size of grille
- Wall and Ceiling Installation: requires Holes/screws
- Floor Installation:
 - Requires Underside Lip when you choose No Holes
 - Thickness 3/16" not recommended
- Aluminum available in 3/16" only

JOB NAME: _____	SUBMITTED BY: _____
LOCATION: _____	
ARCHITECT: _____	
ENGINEER: _____	
CONTRACTOR: _____	



V-812 / Versailles Grille

Spec Sheet

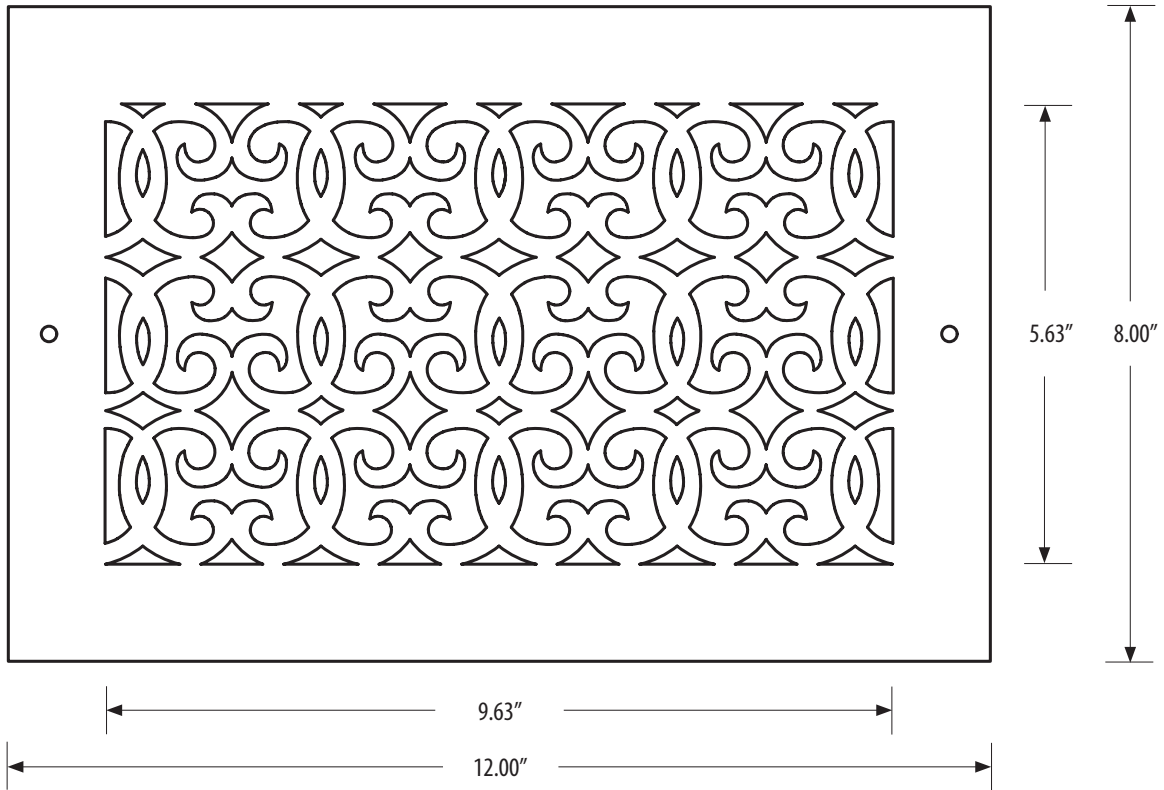

MODEL: V-812

- Duct Size Dimensions: 10.00" x 6.00"
- Outside Dimensions: 12.00" x 8.00"
- Design Dimensions: 9.63" x 5.63"
- Made in USA

OPTIONS:

- **Material:** Aluminum Steel
- **Thickness:** 1/8" 3/16"
- **Finish:** Black Champagne Bronze Grey
 Oil-Rubbed Bronze Satin Nickel Silver
 Sun Gold White
- With Holes (as shown)
 No Holes (cross out holes on drawing)
- Underside Lip No Underside Lip
- With Louver Without Louver

NOTES:

- Pattern scale subject to change with size of grille
- Wall and Ceiling Installation: requires Holes/screws
- Floor Installation:
 - Requires Underside Lip when you choose No Holes
 - Thickness 1/8" not recommended
- Aluminum available in 3/16" only

JOB NAME: _____	SUBMITTED BY: _____
LOCATION: _____	
ARCHITECT: _____	
ENGINEER: _____	
CONTRACTOR: _____	



V-814 / Versailles Grille

Spec Sheet

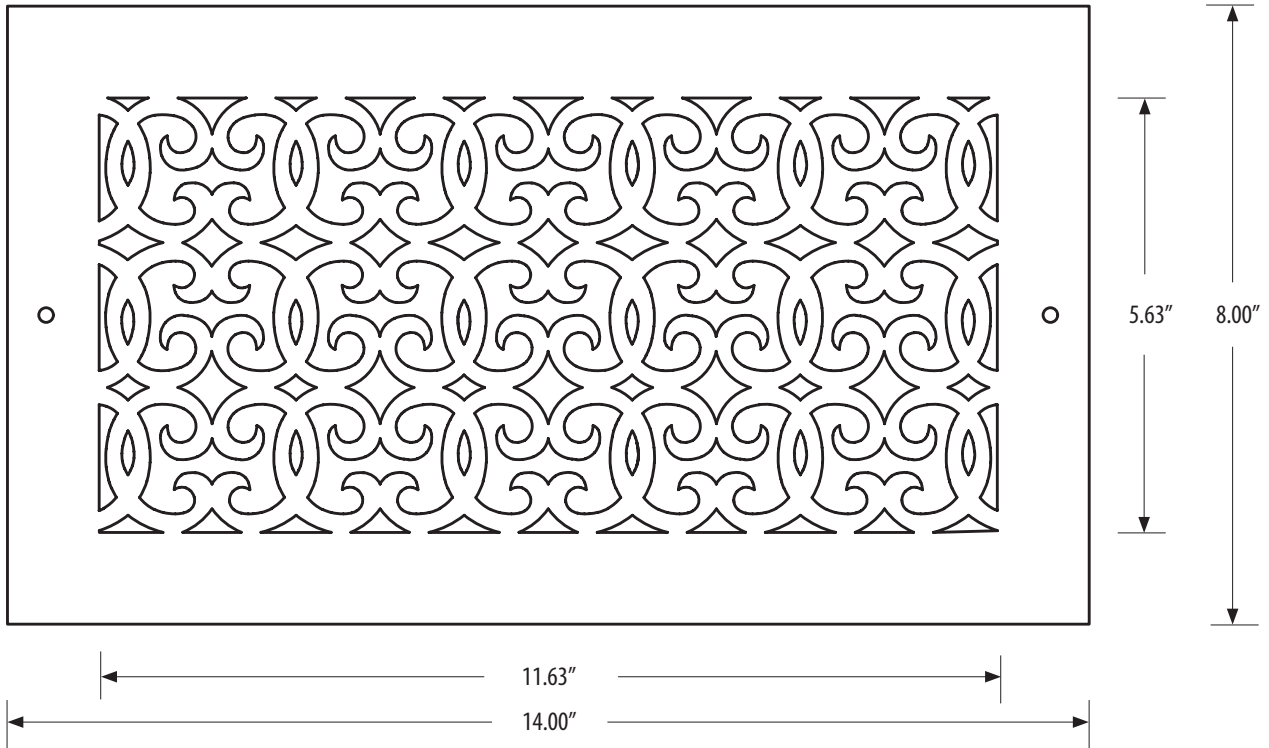

MODEL: V-814

- Duct Size Dimensions: 12.00" x 6.00"
- Outside Dimensions: 14.00" x 8.00"
- Design Dimensions: 11.63" x 5.63"
- Made in USA

OPTIONS:

- **Material:** Aluminum Steel
- **Thickness:** 1/8" 3/16"
- **Finish:** Black Champagne Bronze Grey
 Oil-Rubbed Bronze Satin Nickel Silver
 Sun Gold White
- With Holes (as shown)
 No Holes (cross out holes on drawing)
- Underside Lip No Underside Lip
- With Louver Without Louver

NOTES:

- Pattern scale subject to change with size of grille
- Wall and Ceiling Installation: requires Holes/screws
- Floor Installation:
 - Requires Underside Lip when you choose No Holes
 - Thickness 1/8" not recommended
- Aluminum available in 3/16" only

JOB NAME: _____	SUBMITTED BY: _____
LOCATION: _____	
ARCHITECT: _____	
ENGINEER: _____	
CONTRACTOR: _____	



V-816 / Versailles Grille

Spec Sheet

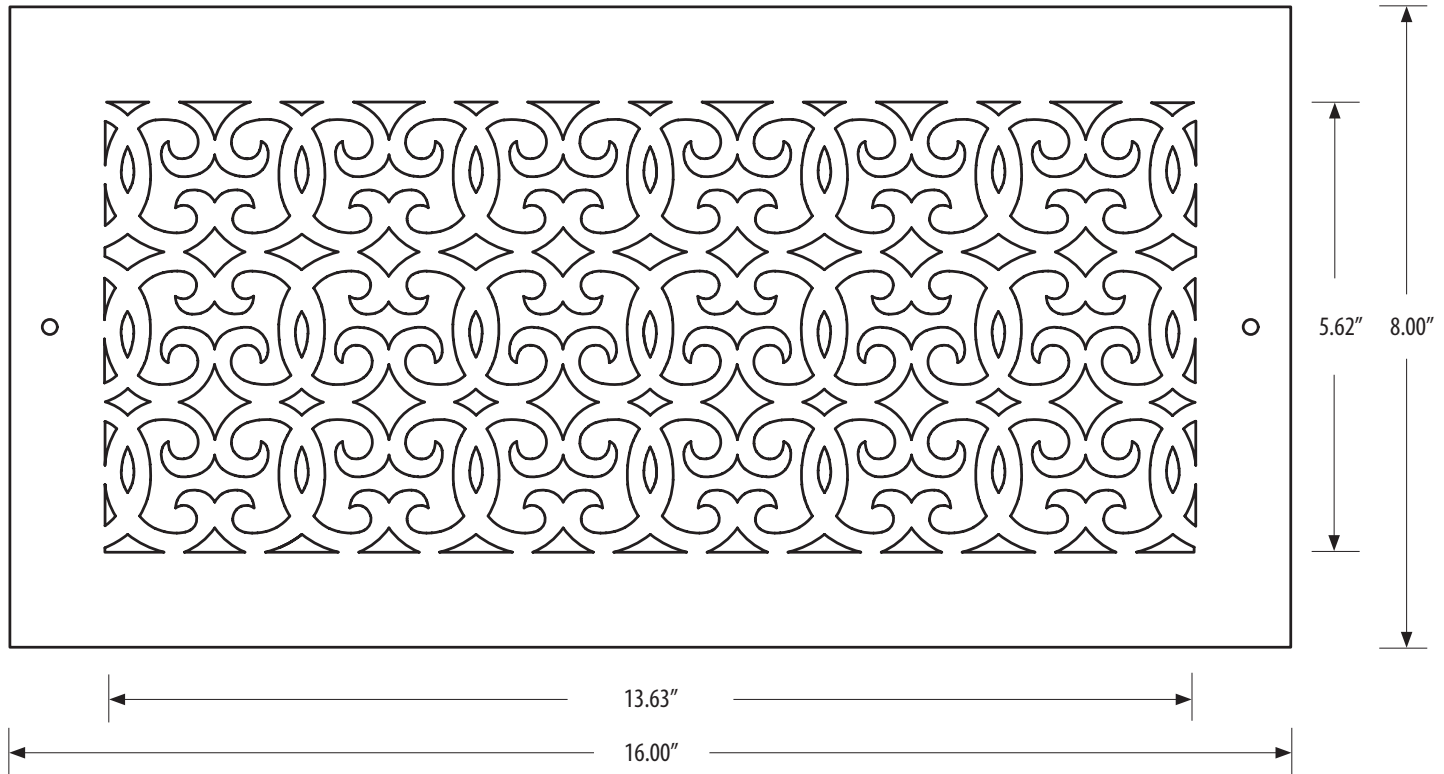

MODEL: V-816

- Duct Size Dimensions: 14.00" x 6.00"
- Outside Dimensions: 16.00" x 8.00"
- Design Dimensions: 13.63" x 5.62"
- Made in USA

OPTIONS:

- **Material:** Aluminum Steel
- **Thickness:** 1/8" 3/16"
- **Finish:** Black Champagne Bronze Grey
 Oil-Rubbed Bronze Satin Nickel Silver
 Sun Gold White
- With Holes (as shown)
 No Holes (cross out holes on drawing)
- Underside Lip No Underside Lip
- With Louver Without Louver

NOTES:

- Pattern scale subject to change with size of grille
- Wall and Ceiling Installation: requires Holes/screws
- Floor Installation:
 - Requires Underside Lip when you choose No Holes
 - Thickness 1/8" not recommended
- Aluminum available in 3/16" only

JOB NAME: _____	SUBMITTED BY: _____
LOCATION: _____	
ARCHITECT: _____	
ENGINEER: _____	
CONTRACTOR: _____	



V-1010 / Versailles Grille

Spec Sheet

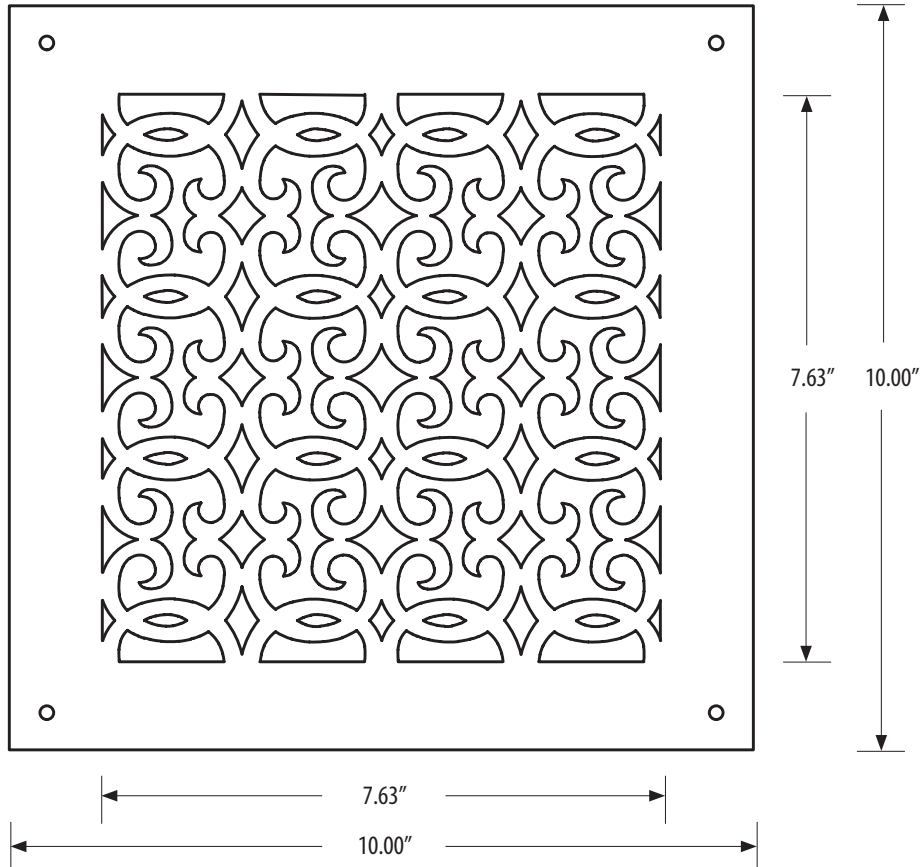

MODEL: V-1010

- Duct Size Dimensions: 8.00" x 8.00"
- Outside Dimensions: 10.00" x 10.00"
- Design Dimensions: 7.63" x 7.63"
- Made in USA

OPTIONS:

- **Material:** Aluminum Steel
- **Thickness:** 1/8" 3/16"
- **Finish:** Black Champagne Bronze Grey
 Oil-Rubbed Bronze Satin Nickel Silver
 Sun Gold White
- With Holes (as shown)
 No Holes (cross out holes on drawing)
- Underside Lip No Underside Lip
- With Louver Without Louver

NOTES:

- Pattern scale subject to change with size of grille
- Wall and Ceiling Installation: requires Holes/screws
- Floor Installation:
 - Requires Underside Lip when you choose No Holes
 - Thickness 1/8" not recommended
- Aluminum available in 3/16" only

JOB NAME: _____	SUBMITTED BY: _____
LOCATION: _____	
ARCHITECT: _____	
ENGINEER: _____	
CONTRACTOR: _____	



V-1012 / Versailles Grille

Spec Sheet

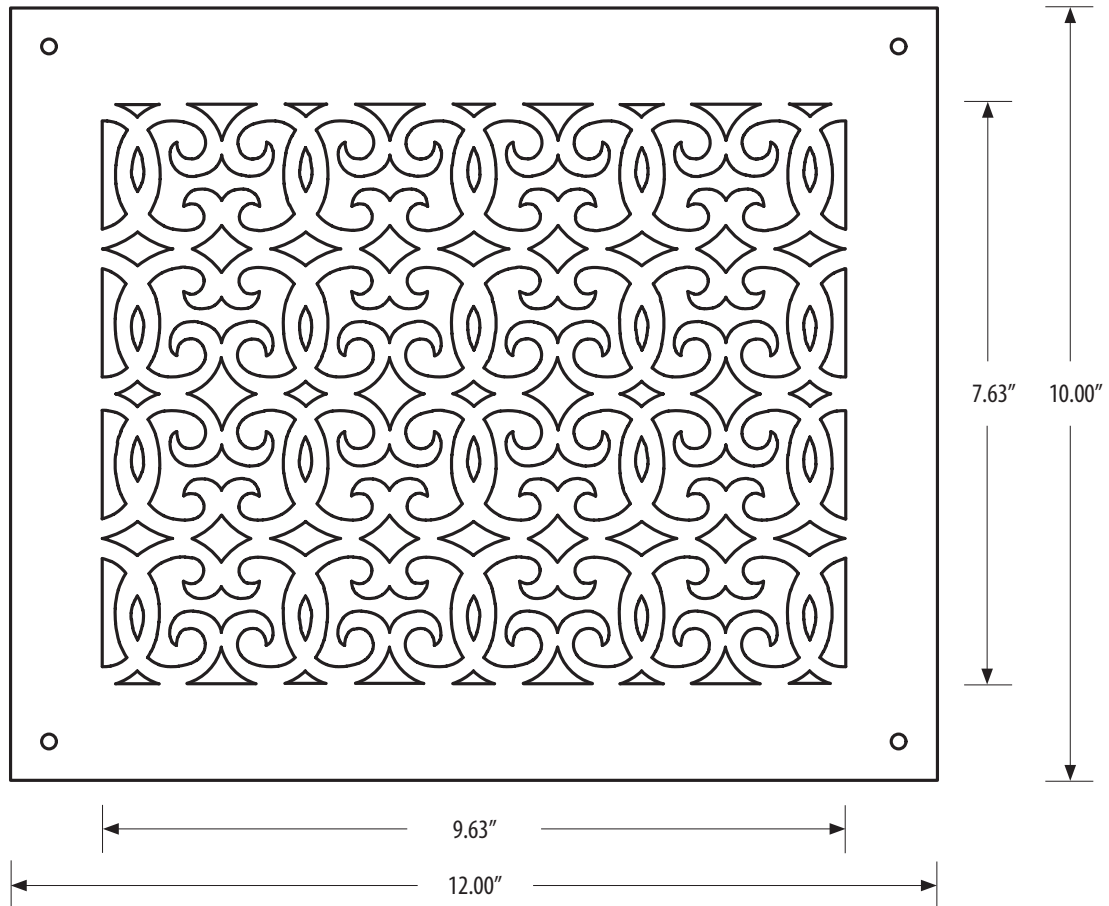

MODEL: V-1012

- Duct Size Dimensions: 10.00" x 8.00"
- Outside Dimensions: 12.00" x 10.00"
- Design Dimensions: 9.63" x 7.63"
- Made in USA

OPTIONS:

- **Material:** Aluminum Steel
- **Thickness:** 1/8" 3/16"
- **Finish:** Black Champagne Bronze Grey
 Oil-Rubbed Bronze Satin Nickel Silver
 Sun Gold White
- With Holes (as shown)
 No Holes (cross out holes on drawing)
- Underside Lip No Underside Lip
- With Louver Without Louver

NOTES:

- Pattern scale subject to change with size of grille
- Wall and Ceiling Installation: requires Holes/screws
- Floor Installation:
 - Requires Underside Lip when you choose No Holes
 - Thickness 1/8" not recommended
- Aluminum available in 3/16" only

JOB NAME: _____	SUBMITTED BY: _____
LOCATION: _____	
ARCHITECT: _____	
ENGINEER: _____	
CONTRACTOR: _____	



V-1014 / Versailles Grille

Spec Sheet

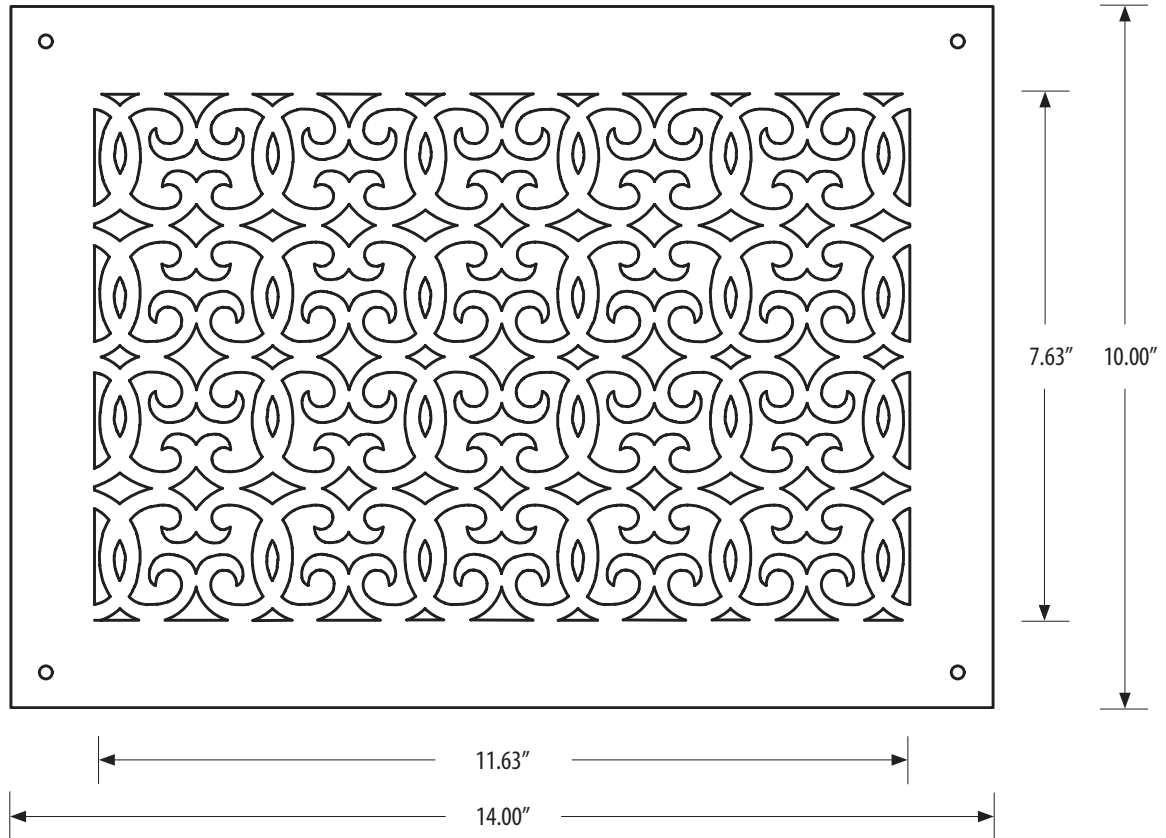

MODEL: V-1014

- Duct Size Dimensions: 12.00" x 8.00"
- Outside Dimensions: 14.00" x 10.00"
- Design Dimensions: 11.63" x 7.63"
- Made in USA

OPTIONS:

- **Material:** Aluminum Steel
- **Thickness:** 1/8" 3/16"
- **Finish:** Black Champagne Bronze Grey
 Oil-Rubbed Bronze Satin Nickel Silver
 Sun Gold White
- With Holes (as shown)
 No Holes (cross out holes on drawing)
- Underside Lip No Underside Lip
- With Louver Without Louver

NOTES:

- Pattern scale subject to change with size of grille
- Wall and Ceiling Installation: requires Holes/screws
- Floor Installation:
 - Requires Underside Lip when you choose No Holes
 - Thickness 1/8" not recommended
- Aluminum available in 3/16" only

JOB NAME: _____	SUBMITTED BY: _____
LOCATION: _____	
ARCHITECT: _____	
ENGINEER: _____	
CONTRACTOR: _____	



V-1016 / Versailles Grille

Spec Sheet

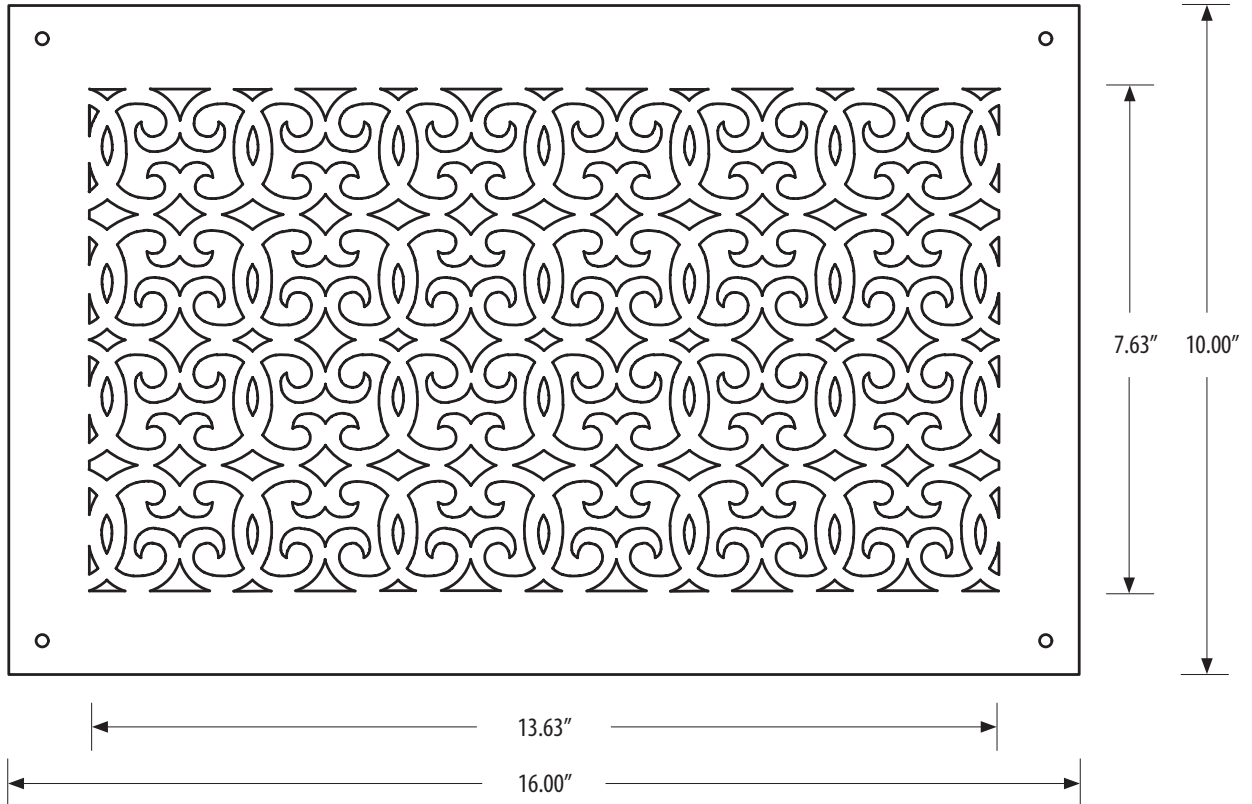

MODEL: V-1016

- Duct Size Dimensions: 14.00" x 8.00"
- Outside Dimensions: 16.00" x 10.00"
- Design Dimensions: 13.63" x 7.63"
- Made in USA

OPTIONS:

- **Material:** Aluminum Steel
- **Thickness:** 1/8" 3/16"
- **Finish:** Black Champagne Bronze Grey
 Oil-Rubbed Bronze Satin Nickel Silver
 Sun Gold White
- With Holes (as shown)
 No Holes (cross out holes on drawing)
- Underside Lip No Underside Lip
- With Louver Without Louver

NOTES:

- Pattern scale subject to change with size of grille
- Wall and Ceiling Installation: requires Holes/screws
- Floor Installation:
 - Requires Underside Lip when you choose No Holes
 - Thickness 1/8" not recommended
- Aluminum available in 3/16" only

JOB NAME: _____	SUBMITTED BY: _____
LOCATION: _____	
ARCHITECT: _____	
ENGINEER: _____	
CONTRACTOR: _____	



V-1212 / Versailles Grille

Spec Sheet

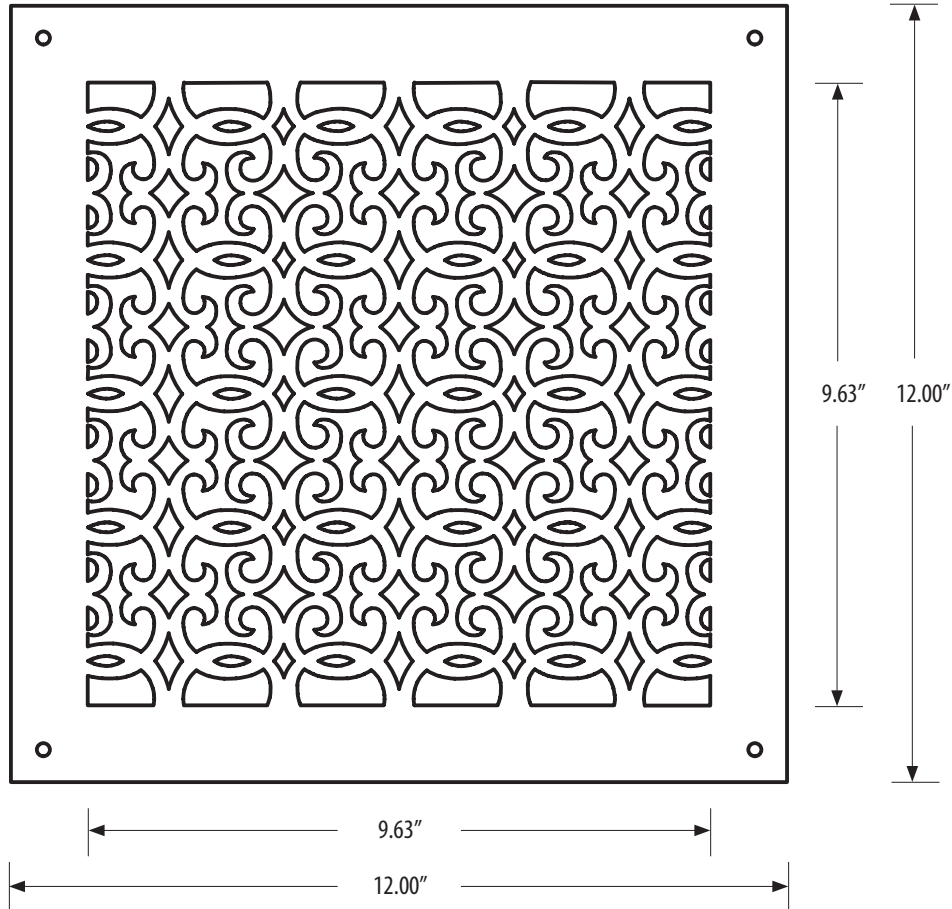

MODEL: V-1212

- Duct Size Dimensions: 10.00" x 10.00"
- Outside Dimensions: 12.00" x 12.00"
- Design Dimensions: 9.63" x 9.63"
- Made in USA

OPTIONS:

- **Material:** Aluminum Steel
- **Thickness:** 1/8" 3/16"
- **Finish:** Black Champagne Bronze Grey
 Oil-Rubbed Bronze Satin Nickel Silver
 Sun Gold White
- With Holes (as shown)
 No Holes (cross out holes on drawing)
- Underside Lip No Underside Lip
- With Louver Without Louver

NOTES:

- Pattern scale subject to change with size of grille
- Wall and Ceiling Installation: requires Holes/screws
- Floor Installation:
 - Requires Underside Lip when you choose No Holes
 - Thickness 1/8" not recommended
- Aluminum available in 3/16" only

JOB NAME: _____	SUBMITTED BY: _____
LOCATION: _____	
ARCHITECT: _____	
ENGINEER: _____	
CONTRACTOR: _____	



V-1414 / Versailles Grille

Spec Sheet

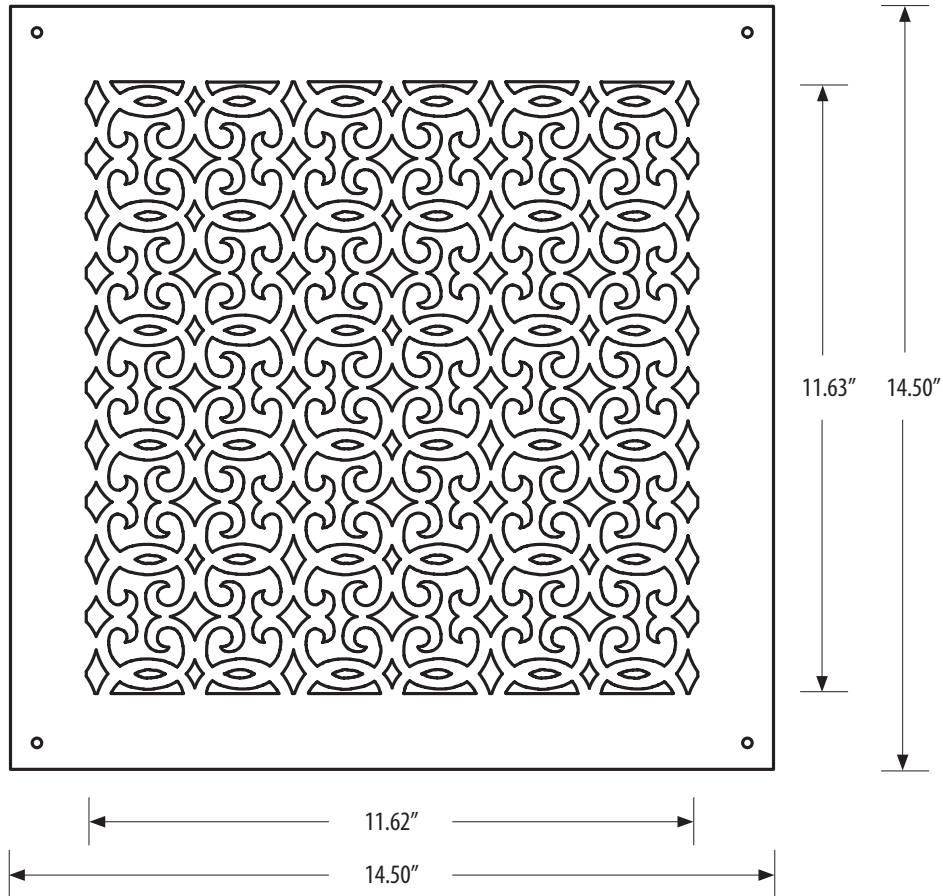

MODEL: V-1414

- Duct Size Dimensions: 12.00" x 12.00"
- Outside Dimensions: 14.50" x 14.50"
- Design Dimensions: 11.62" x 11.63"
- Made in USA

OPTIONS:

- **Material:** Aluminum Steel
- **Thickness:** 1/8" 3/16"
- **Finish:** Black Champagne Bronze Grey
 Oil-Rubbed Bronze Satin Nickel Silver
 Sun Gold White
- With Holes (as shown)
 No Holes (cross out holes on drawing)
- Underside Lip No Underside Lip
- With Louver Without Louver

NOTES:

- Pattern scale subject to change with size of grille
- Wall and Ceiling Installation: requires Holes/screws
- Floor Installation:
 - Requires Underside Lip when you choose No Holes
 - Thickness 1/8" not recommended
- Aluminum available in 3/16" only

JOB NAME: _____	SUBMITTED BY: _____
LOCATION: _____	
ARCHITECT: _____	
ENGINEER: _____	
CONTRACTOR: _____	